

# Cisco Catalyst 9600 Series Line Card Installation Note

**First Published:** 2019-04-15

**Last Modified:** 2024-02-02

## Overview of Cisco Catalyst 9600 Series Line Cards

This document describes the features of a Cisco Catalyst 9600 Series line card. It also provides information about how to correctly install or replace a line card in the chassis.

**Table 1: Supported Line Cards**

Product ID	Description
C9600-LC-48YL	Cisco Catalyst 9600 Series 48-port 50G <sup>1</sup> /25G/10G/1G module.
C9600-LC-24C	Cisco Catalyst 9600 Series 24-port 100G/40G or 12-port 100G module.
C9600-LC-48TX	Cisco Catalyst 9600 Series 48-port 10G/5G/2.5G/1G/100 Mbps/10 Mbps module.
C9600-LC-48S	Cisco Catalyst 9600 Series 48-port 1G module.
C9600-LC-40YL4CD	Cisco Catalyst 9600 Series 40-port 50G/ 25G/10G, 2-port 200G/100G/40G, 2-port 400G/200G/100G/40G module.
C9600X-LC-32CD	Cisco Catalyst 9600 Series 30-Port 100G/40G, 2-Port 400G/100G module.
C9600X-LC-56YL4C	Cisco Catalyst 9600 Series 56-Port 50G/25G/10G, 4-Port 100G/40G module.

<sup>1</sup> G stands for Gigabit Ethernet.

## Features of Cisco Catalyst 9600 Series Line Cards

The following sections describe the major features available on the line cards that are supported on Cisco Catalyst 9600 Series switches. The document also explains the front view of the line cards and the different LEDs available.

### Cisco Catalyst 9600 Series 56-Port 50G/25G/10G, 4-Port 100G/40G (C9600X-LC-56YL4C)

The following figure shows the front view of a 56-Port 50G/25G/10G, 4-Port 100G/40G (C9600X-LC-56YL4C) with the major features identified.

Figure 1: Cisco Catalyst 9600 Series 56-Port 50G/25G/10G, 4-Port 100G/40G (C9600X-LC-56YL4C)

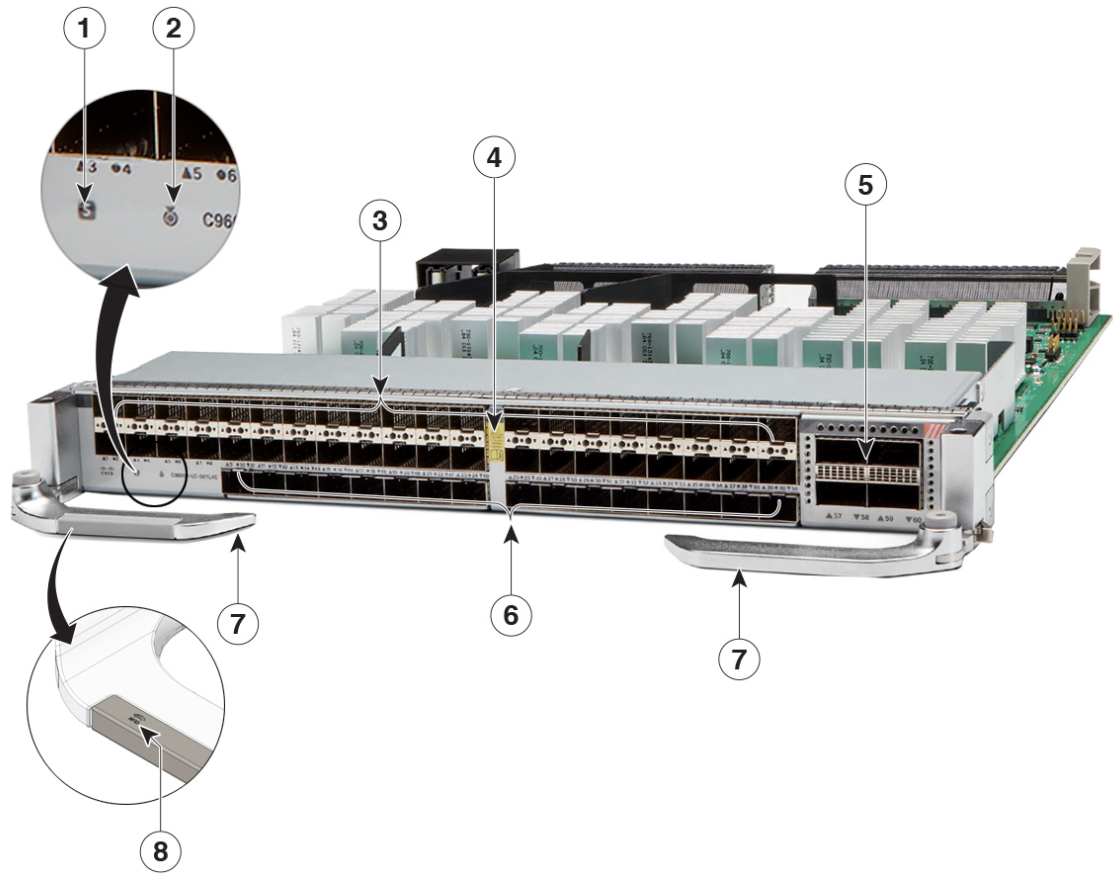

Table 2: Front Panel Components

1	Status LED	5	4 x 100G/40G QSFP28 ports • Ports 57 to 60: 100G/40G
2	Locate (Blue beacon) LED	6	Port Link LEDs
3	56 x 50G/25G/10G SFP56 ports • Ports 1 to 56: 50G/25G/10G	7	Ejector levers
4	Sharp-edge hazard icon	8	RFID embedded on the left ejector lever

**Table 3: Features Supported on Cisco Catalyst 9600 Series 56-Port 50G/25G/10G, 4-Port 100G (C9600X-LC-56YL4C)**

Feature	Description
Ports per module	<ul style="list-style-type: none"> <li>Provides 56 SFP56 ports of 50G or 25G or 10G speeds.</li> <li>Provides 4 QSFP28 ports of 100G or 40G speeds.</li> <li>Two ports per port group. A port group constitutes the top and bottom consecutive ports in a module.</li> </ul> <p><b>Caution</b> C9600-LC-56YL4C has very high port density, and because of thermal limitations, if you use the SFP modules with more than 1.5W of power (for example, SFP-10G-T-X), we recommend that you must insert these high-power modules into ports 1 to 8.</p>
Supervisor module compatibility	Supports only C9600X-SUP-2.
Breakout connectivity	Supports 4 x 10G and 4 x 25G breakout cables.
Chassis slot restrictions	C9606R: Slots 1, 2, 5, and 6 only. However, you can install a line card in any of the supported slots.
Bandwidth per slot	6.4Tbps full-duplex per slot with C9600X-SUP-2.

**Cisco Catalyst 9600 Series 30-Port 100G/40G, 2-Port 400G/100G (C9600X-LC-32CD)**

The following figure shows the front view of a Cisco Catalyst 9600 Series 30 ports of 100G/40G QSFP28, 2-port 400G QSFP-DD line card (C9600X-LC-32CD) with major features identified.

Figure 2: Cisco Catalyst 9600 Series 30-Port 100G/40G, 2-Port 400G/100G Line Card (C9600X-LC-32CD)

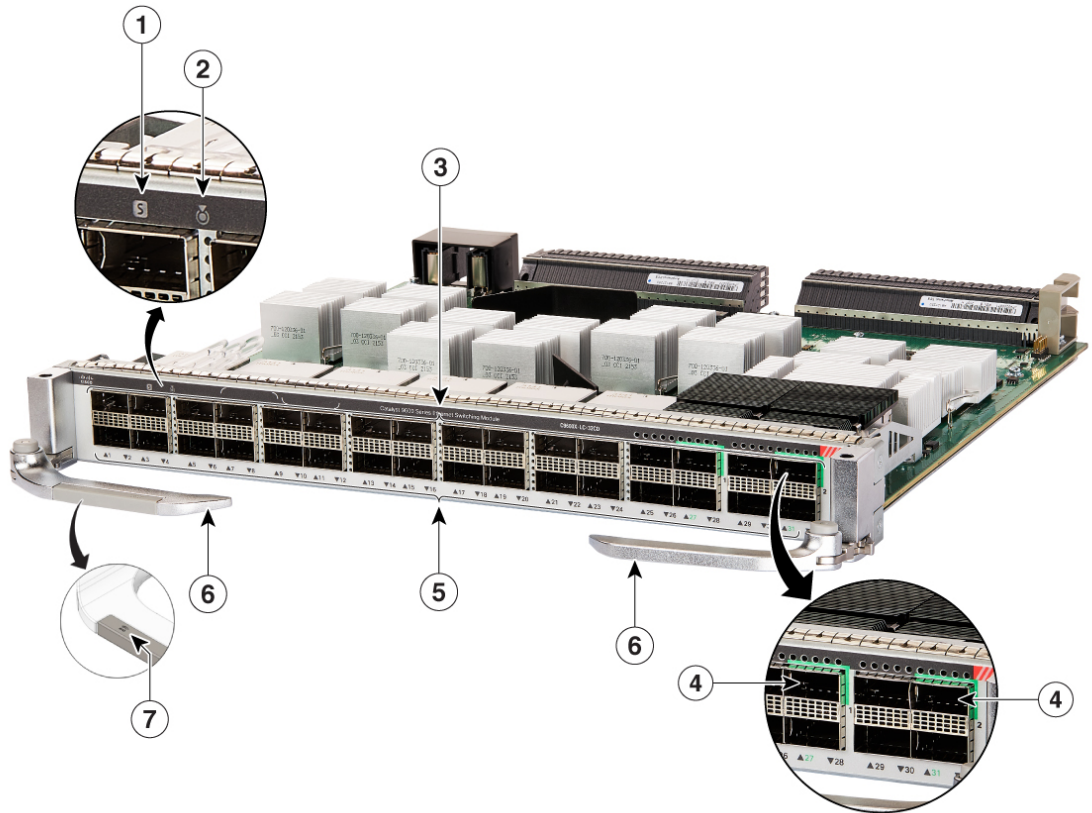

468351

Table 4: Front Panel Components of C9600X-LC-32CD

1	Status LED	5	Port Link LEDs
2	Locate (Blue beacon) LED	6	Ejector levers
3	30 QSFP28 ports	7	RFID embedded on the left ejector lever
4	2 QSFP-DD ports	-	-

**Table 5: Features Supported on C9600X-LC-32CD**

Feature	Description
Ports per module	Provides by default 24 QSFP28 ports and 8 QSFP-DD ports. QSFP28 ports support 100G or 40G speed, whereas QSFP-DD ports support 400G/100G/40G speeds. Note that of the 8 QSFP-DD ports, only two ports are 400G enabled.  Supports the following three modes: <ul style="list-style-type: none"> <li>• 100G connectivity on all 32 ports, by default.</li> <li>• 100G connectivity on 28 ports and 1 x 400G on the QSFPDD port in a port group<sup>2</sup>.</li> <li>• 100G connectivity on 24 ports and 2 x 400G on the QSFPDD ports in both the port groups.</li> </ul>
Supervisor module compatibility	Supports C9600X-SUP-2.
Chassis slot restrictions	C9606R: Slots 1, 2, 5, and 6 only. However, you can install a line card in any of the supported slots.
Hardware restrictions	None
Bandwidth per slot	6.4 Tbps full-duplex per slot with C9600X-SUP-2

<sup>2</sup> A port group consists of 4 ports.

**Figure 3: 100G/400G Configuration on C9600X-LC-32CD**

The following figure shows 100G connectivity on 24 ports and 2 x 400G on the QSFPDD ports in both the port groups.

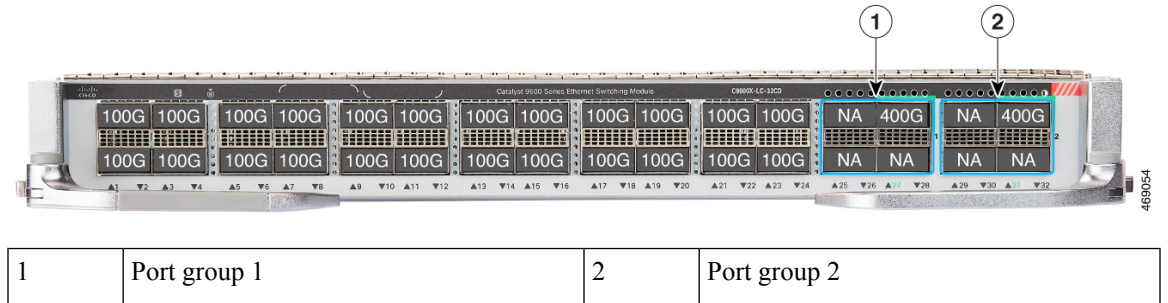

**Cisco Catalyst 9600 Series 40-Port 50G, 2-Port 200G, 2-Port 400G Line Card (C9600-LC-40YL4CD)**

The following figure shows the front view of a Cisco Catalyst 9600 Series 40-port 50G/25G/10G SFP56, 2-port 200G/100G/40G QSFP56 and 2-port 400G/200G/100G/40G QSFP-DD line card (C9600-LC-40YL4CD) with major features identified.

Figure 4: Cisco Catalyst 9600 Series 40-Port 50G, 2-Port 200G, 2-Port 400G Line Card (C9600-LC-40YL4CD)

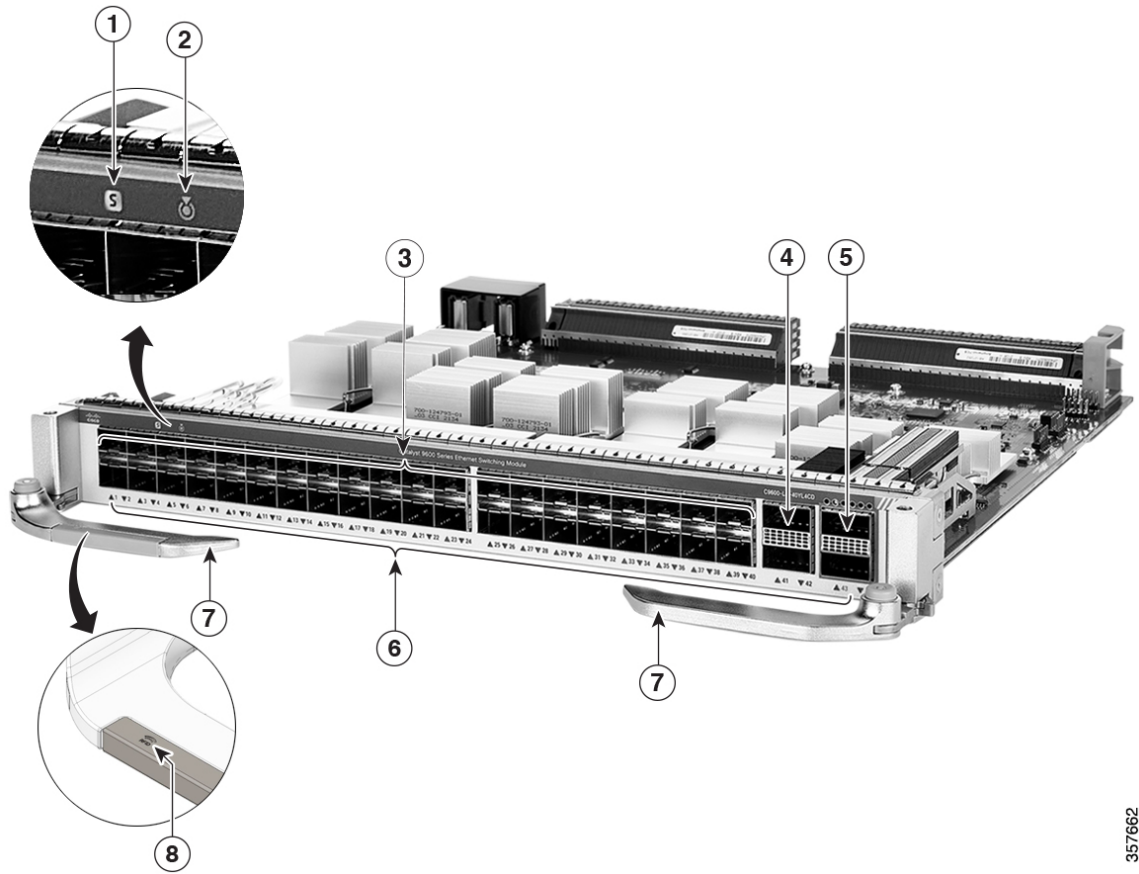

357662

Table 6: Front Panel Components of C9600-LC-40YL4CD

1	Status LED	5	2 x 400G/200G/100G/40G QSFP-DD ports
2	Locate (Blue beacon) LED	6	Port Link LEDs
3	40 x 50G/25G/10G SFP56 ports	7	Ejector levers
4	2 x 200G/100G/40G QSFP56 ports	8	RFID embedded on the left ejector lever

Table 7: Features Supported on C9600-LC-40YL4CD

Feature	Description
Ports per module	<ul style="list-style-type: none"> <li>Provides 40 SFP56 ports, 2 QSFP56 ports and 2 QSFP-DD ports. SFP56 ports support 50G or 25G or 10G, whereas QSFP56 ports support 200G/100G/40G and QSFP-DD ports support 400G/200G/100G/40G speeds.</li> <li>With C9600X-SUP-2, the line card provides 40 ports of 50G/25G/10G, 2 ports of 200G/100G/40G and 2 ports of 400G/200G/100G/40G.</li> <li>With C9600-SUP-1, the line card provides 40 ports of 25G/10G/1G and 2 ports of 100G/40G.</li> </ul>
Supervisor module compatibility	Supports C9600X-SUP-2 and C9600-SUP-1.
Cisco QSFP to SFP or SFP+ Adapter (QSA) adapter (CVR-QSFP-SFP10G) support	Provides 10G/1G connectivity on all the QSFP ports, depending on the supervisor module installed. With C9600X-SUP-2 installed in the chassis, you can use the QSA adapter and 10G transceivers and with C9600-SUP-1, you can use 10G and 1G transceivers.
Chassis slot restrictions	C9606R: Slots 1, 2, 5, and 6 only. However, you can install a line card in any of the supported slots.
Hardware restrictions	<ul style="list-style-type: none"> <li>QSFP-DD ports are not supported when you have installed Cisco Catalyst 9600 Series Supervisor 1 Module (C9600-SUP-1) in the chassis.</li> <li>With C9600X-SUP-2, you cannot configure two different speeds on adjacent SFP56 ports in a port group<sup>3</sup>. For example, configuring 10G speed on port 1 and 25G on port 2 where ports 1 and 2 constitute a port group is not permissible.</li> </ul>
Bandwidth per slot	<ul style="list-style-type: none"> <li>2.4 Tbps full-duplex per slot with C9600-SUP-1</li> <li>6.4 Tbps full-duplex per slot with C9600X-SUP-2</li> </ul>

<sup>3</sup> A port group constitutes the top and bottom consecutive ports in a module.

### Cisco Catalyst 9600 Series 24-Port 100G/40G or 12-Port 100G (C9600-LC-24C)

The following figure shows the front view of a Cisco Catalyst 9600 Series 24-port 100G/40G or 12-port 100G (C9600-LC-24C) with major features identified.

Figure 5: Cisco Catalyst 9600 Series 24-Port 100G/40G or 12-Port 100G (C9600-LC-24C)

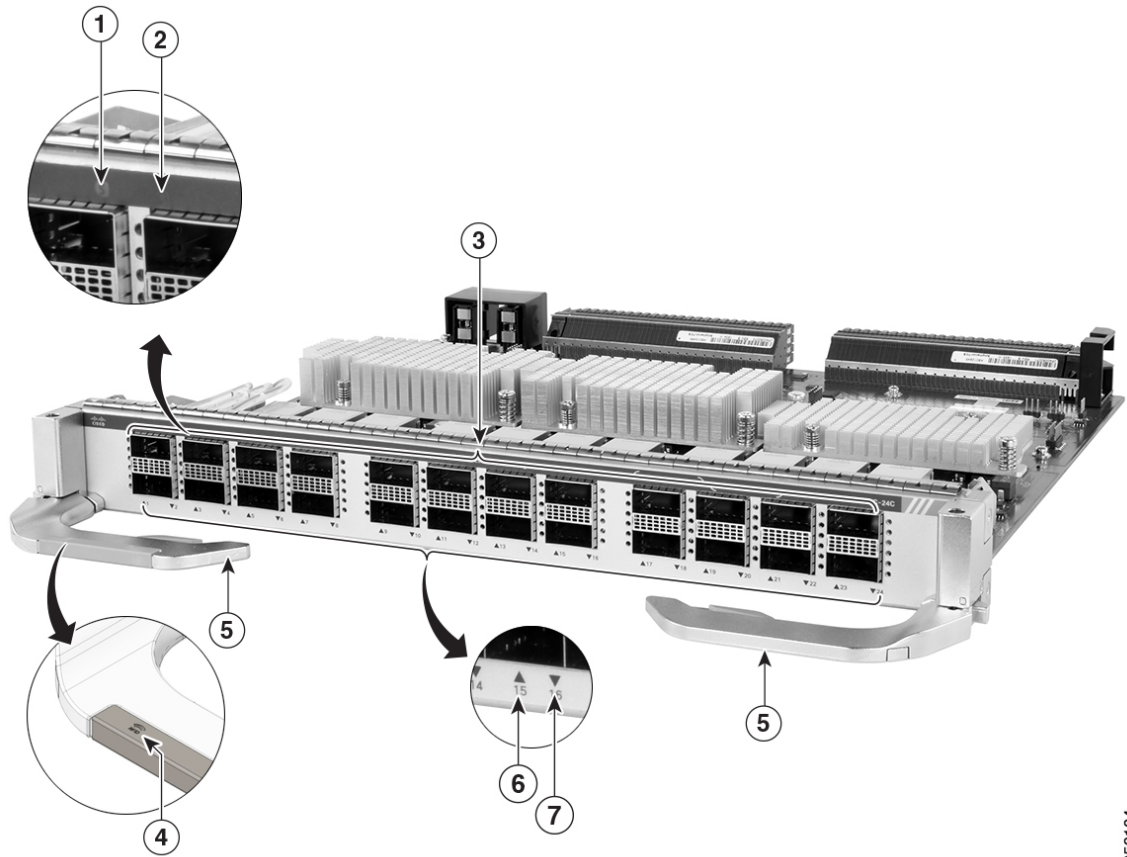

356104

Table 8: Front Panel Components

1	Status LED	5	Ejector levers
2	Locate (Blue beacon) LED	6	Port Link LED for the port in the top row
3	100G QSFP28 or 40G QSFP+ ports	7	Port Link LED for the port in the bottom row
4	RFID embedded on the left ejector lever	-	-

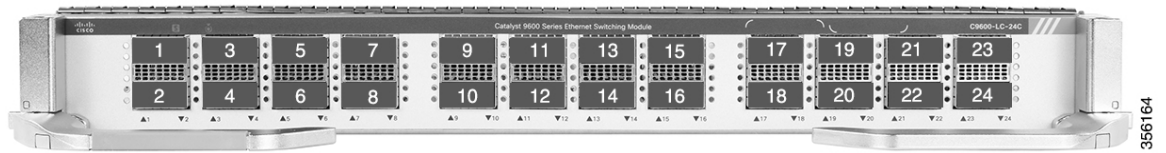

Table 9: Features Supported on Cisco Catalyst 9600 Series 24-Port 100G/40G or 12-Port 100G (C9600-LC-24C)

Feature	Description
Ports per module	<ul style="list-style-type: none"> <li>Provides 24 QSFP28 ports of 40G or 100G.</li> <li>Provides 24 ports of 40G and 12 ports of 100G, with C9600-SUP-1. All the 24 ports are configured as 40G by default. Only the odd-numbered ports can be configured as 100G, if required.</li> <li>Provides 40G and 100G support on all ports when used with C9600X-SUP-2.</li> <li>Two ports per port group. A port group constitutes the top and bottom consecutive ports in a module.</li> </ul>
Supervisor module compatibility	Supports C9600X-SUP-2 and C9600-SUP-1.
Cisco QSFP to SFP or SFP+ Adapter (QSA) module (CVR-QSFP-SFP10G) support	<p>Provides 10G connectivity on QSFP ports by converting a 40G/100G QSFP port into an SFP/SFP+ port. 1G connectivity using QSA module is available only with C9600-SUP-1.</p> <p>The line card supports the following configurations using a QSA module in a port group:</p> <ul style="list-style-type: none"> <li>Configuring odd-numbered (top) and even-numbered (bottom) ports with the QSA module.</li> <li>Configuring odd-numbered ports with the QSA module and even-numbered ports with 40G QSFP optics.</li> </ul> <p><b>Note</b> If you configure an odd-numbered port with 40G QSFP optics and the even-numbered port with the QSA module, the QSA module in the even-numbered port will not work.</p>
Breakout connectivity	Supports 4 x 10G and 4 x 25G breakout cables on the odd numbered ports.
Chassis slot restrictions	C9606R: Slots 1, 2, 5, and 6 only. However, you can install a line card in any of the supported slots.
Hardware restrictions	Configurations with QSFP optics plugged into the top port and the QSA adapter into the bottom port in a port group are not supported.
Bandwidth per slot	<ul style="list-style-type: none"> <li>2.4 Tbps full-duplex per slot with C9600-SUP-1</li> <li>4.8 Tbps full-duplex per slot with C9600X-SUP-2</li> </ul>

**Table 10: Port Mapping for C9600-LC-24C**

Port Type	Port Numbering on the Line Card
40G native ports	1–24
100G native ports	<ul style="list-style-type: none"> <li>• 25–48 with C9600-SUP-1</li> <li>• 1–24 with C9600X-SUP-2</li> </ul>

**Figure 6: 40G/100G Port Numbering on C9600-LC-24C****Figure 7: 100G Port Numbering on C9600-LC-24C**

The following port numbering is applicable only when you are using C9600-LC-24C with C9600-SUP-1.

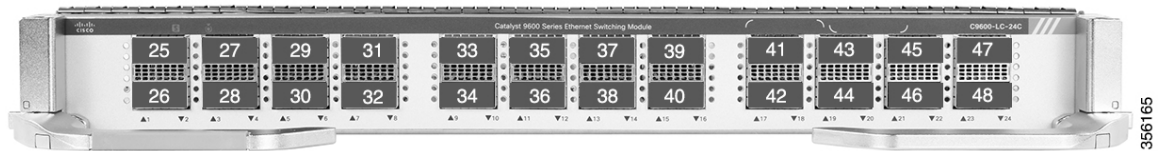
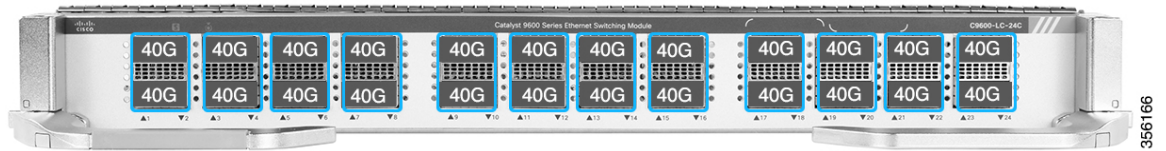
**Figure 8: 40G (Default) Configuration on C9600-LC-24C**

By default, all the interfaces on a C9600-LC-24C are 40G enabled. The default 40G interfaces can be configured to function as 100G ports using the CLI. However, from each port group, only the odd numbered ports can be configured with 100G speed; the even numbered ports in a port group are disabled.

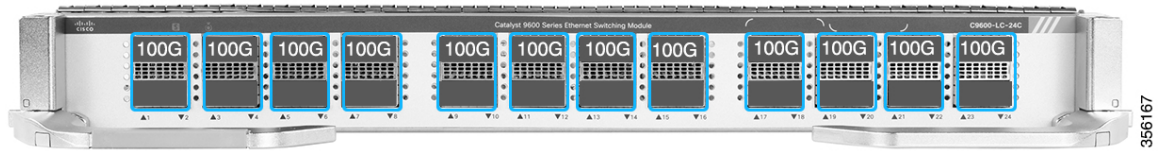
**Figure 9: 100G Configuration on C9600-LC-24C with C9600-SUP-1****Figure 10: 100G Configuration on C9600-LC-24C with C9600X-SUP-2**

With C9600X-SUP-2, you can configure all the 24 ports on the line card as 100G ports.

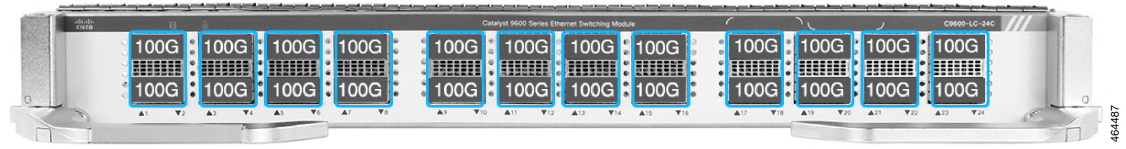

**Cisco Catalyst 9600 Series 48-Port 50G/25G/10G/1G (C9600-LC-48YL)**

The following figure shows the front view of a 48-port 50G/25G/10G/1G (C9600-LC-48YL) with the major features identified.

**Figure 11: Cisco Catalyst 9600 Series 48-Port 50G/25G/10G/1G (C9600-LC-48YL)**

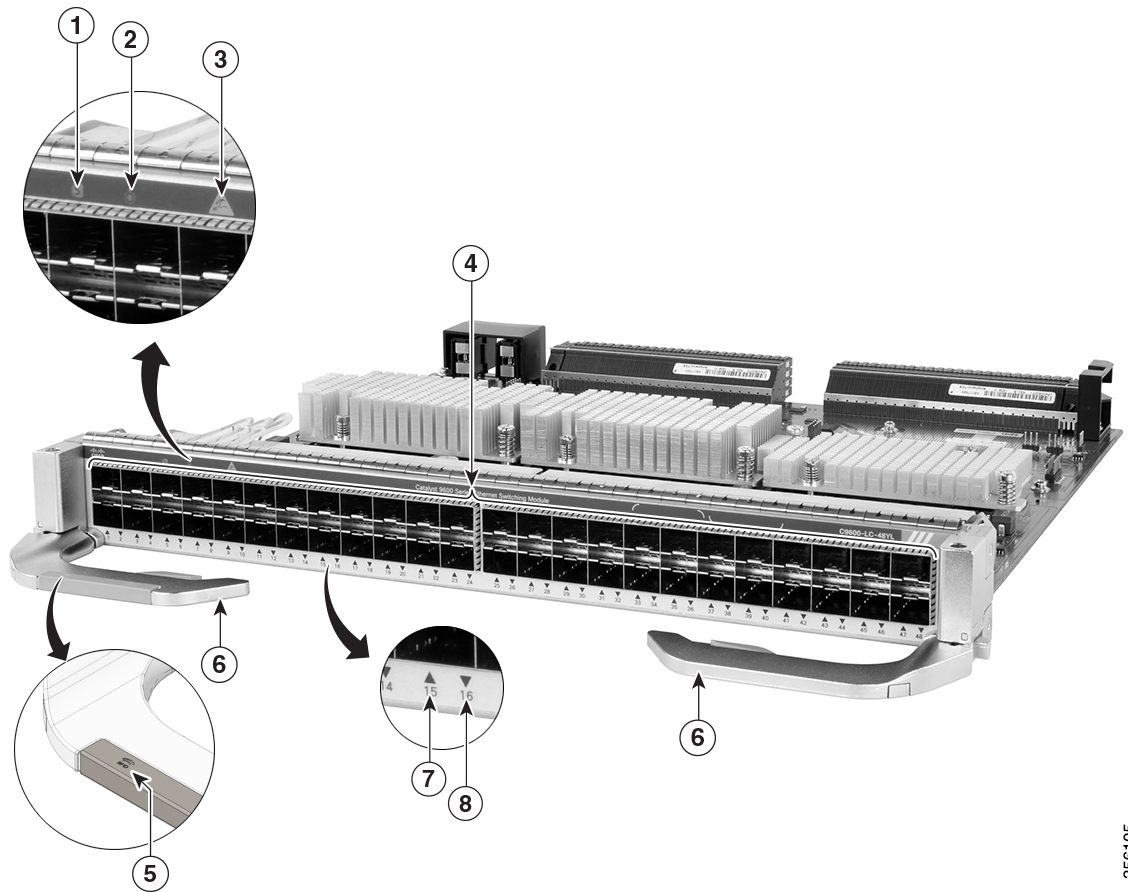

**Table 11: Front Panel Components**

1	Status LED	5	RFID embedded on the left ejector lever
2	Locate (Blue beacon) LED	6	Ejector levers
3	Sharp-edge hazard icon	7	Port Link LED for the port in the top row
4	50G/25G/10G/1G SFP56/SFP28/SFP+ ports	8	Port Link LED for the port in the bottom row

**Table 12: Features Supported on Cisco Catalyst 9600 Series 48-Port 25G/10G/1G (C9600-LC-48YL)**

Feature	Description
Ports per module	<ul style="list-style-type: none"> <li>Provides 48 50G, 25G, 10G, or 1G interfaces by default. These ports can be interchangeably used as 50G, 25G, 10G, and 1G ports.</li> <li>When used in conjunction with C9600X-SUP-2, all the 48 ports support 50G, 25G, and 10G speeds. With C9600-SUP-1, all the 48 ports support 25G, 10G, or 1G speeds.</li> </ul>
Supervisor module compatibility	Supports C9600X-SUP-2 and C9600-SUP-1.
Chassis slot restrictions	C9606R: Slots 1, 2, 5, and 6 only. However, you can install a line card in any of the supported slots.
Hardware restrictions	With C9600X-SUP-2, you cannot configure two different speeds on ports in a port group <sup>4</sup> . For example, configuring 10G speed on port 1 and 25G on port 2 where ports 1 and 2 constitute a port group is not permissible.
Bandwidth per slot	<ul style="list-style-type: none"> <li>2.4 Tbps full-duplex per slot with C9600-SUP-1</li> <li>4.8 Tbps full-duplex per slot with C9600X-SUP-2</li> </ul>

<sup>4</sup> A port group constitutes the top and bottom consecutive ports in a module.

### Cisco Catalyst 9600 Series 48-Port 10G/5G/2.5G/1G/100 Mbps/10 Mbps (C9600-LC-48TX)

The following figure shows the front view of a 48-port 10G/5G/2.5G/1G/100 Mbps/10 Mbps (C9600-LC-48TX) with the major features identified.

Figure 12: Cisco Catalyst 9600 Series 48-Port 10G/5G/2.5G/1G/100 Mbps/10 Mbps (C9600-LC-48TX)

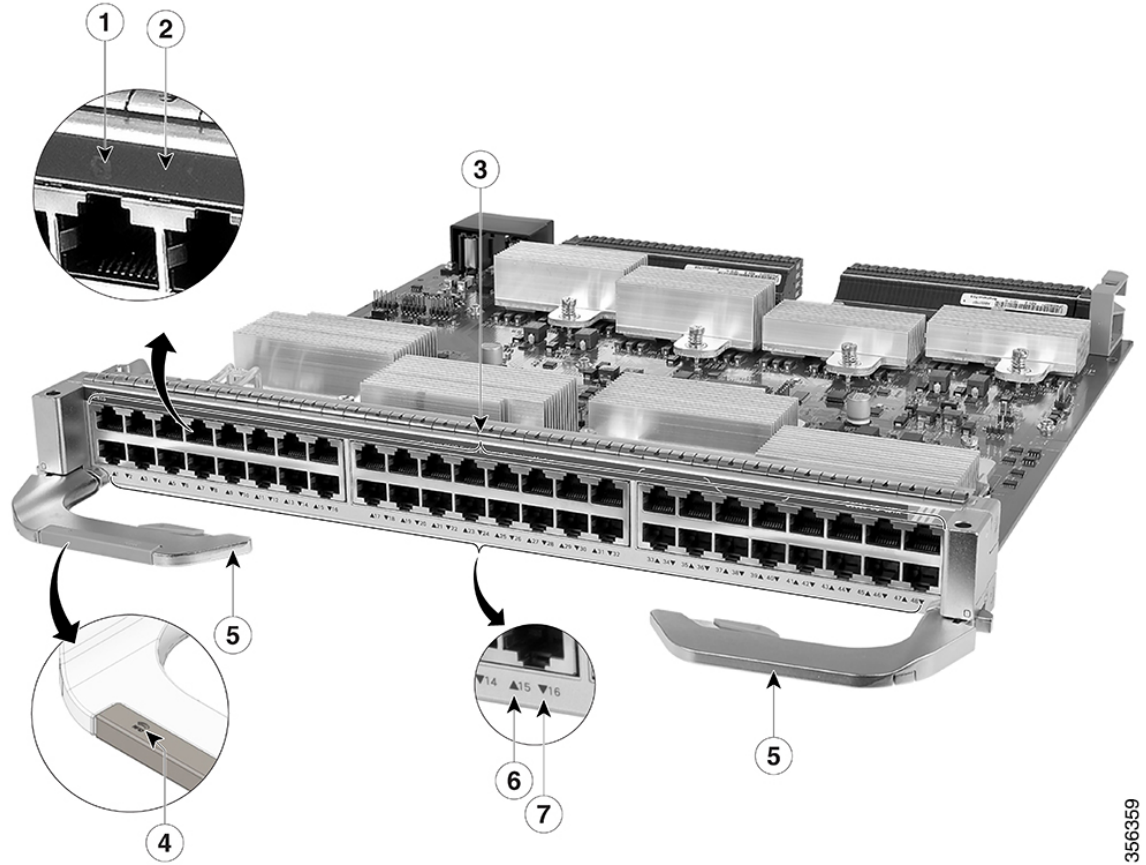

356359

Table 13: Front Panel Components

1	Status LED	5	Ejector levers
2	Locate (Blue beacon) LED	6	Port Link LED for the port in the top row
3	10G/5G/2.5G/1G/100 Mbps/10 Mbps RJ45 copper ports	7	Port Link LED for the port in the bottom row
4	RFID embedded on the left ejector lever	-	-

**Table 14: Features Supported on Cisco Catalyst 9600 Series 48-Port 10G/5G/2.5G/1G/100 Mbps/10 Mbps (C9600-LC-48TX)**

Feature	Description
Ports per module	<ul style="list-style-type: none"> <li>• With C9600-SUP-1,               <ul style="list-style-type: none"> <li>• Provides 48 10G, 5G, 2.5G, 1G, 100 Mbps and 10 Mbps interfaces by default. These ports can be interchangeably used as 10G, 5G, 2.5G, 1G, 100 Mbps and 10 Mbps ports.</li> <li>• All the 48 ports support 10G, 5G, 2.5G, 1G, 100 Mbps and 10 Mbps speeds.</li> </ul> </li> <li>• With C9600X-SUP-2, provides 48 ports of 10G speed.</li> </ul>
Supervisor module compatibility	Supports C9600X-SUP-2 and C9600-SUP-1.
Chassis slot restrictions	C9606R: Slots 1, 2, 5, and 6 only. However, you can install a line card in any of the supported slots.
Bandwidth per slot	960 Gbps full-duplex per slot

**Cisco Catalyst 9600 Series 48-Port 1G (C9600-LC-48S)**

The following figure shows the front view of a 48-port 1G (C9600-LC-48S) with the major features identified.

Figure 13: Cisco Catalyst 9600 Series 48-Port 1G (C9600-LC-48S)

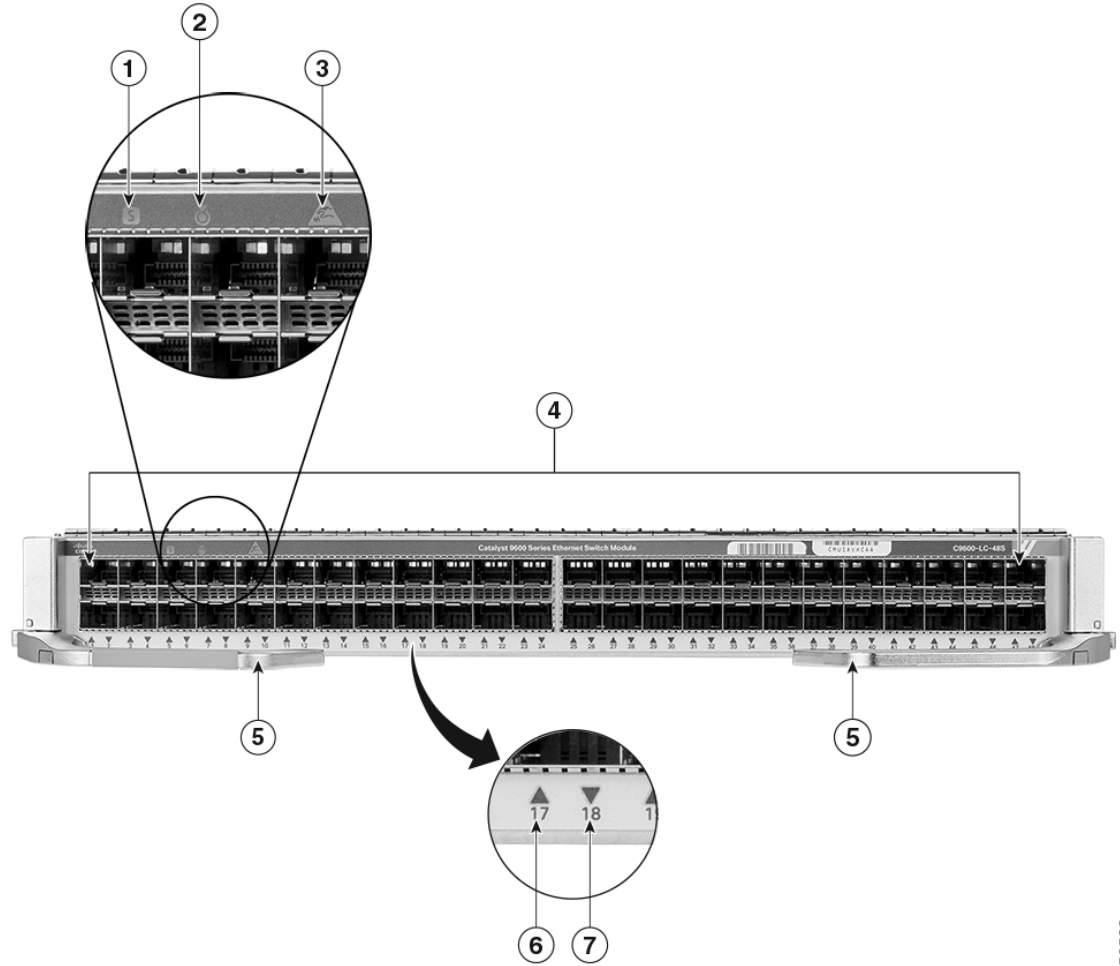

3566538

Table 15: Front Panel Components

1	Status LED	5	Ejector levers
2	Locate (Blue beacon) LED	6	Port Link LED for the port in the top row
3	Sharp-edge hazard icon	7	Port Link LED for the port in the bottom row
4	1G SFP ports	-	-



Table 16: Features Supported on Cisco Catalyst 9600 Series 48-Port 1G (C9600-LC-48S)

Feature	Description
Ports per module	<ul style="list-style-type: none"> <li>• 48 SFP ports of 1G: Provides 48 1G interfaces.</li> <li>• All the 48 ports support 1G speed.</li> </ul>

Feature	Description
Supervisor module compatibility	Supports only C9600-SUP-1.
Chassis slot restrictions	C9606R: Slots 1, 2, 5, and 6 only. However, you can install a line card in any of the supported slots.
Bandwidth per slot	96 Gbps full-duplex per slot

## Line Card LEDs

Table 17: Line Card LEDs

LED Type	LED Position or Colour	Meaning
 Blue Beacon	Blue	Indicates that the module requires attention. Provisioned by the administrator of the system.
	Off	Indicates that the module does not need any attention.
	Slow Blinking Blue	Indicates that the module requires attention. Configured by the user. The LED blinks at a rate of 1.2 seconds.
	Fast Blinking Blue	Indicates that the module requires attention. The LED blinks at a rate of 0.6 seconds.
	<p>From Cisco IOS XE Cupertino 17.9.x, the blue beacon LED on C9600X-LC-32CD and C9600-LC-40YL4CD can be configured to blink at slow, fast or steady (no blink) rates, which can be used to identify devices that need to be serviced. For example, if you have to make changes to the three Field Replaceable Units (FRU) in the system, you can configure the FRUs to use the beacon LED at three different blinking rates. This helps you to identify the FRU that is undergoing a change. Also, you can configure the beacon LED to use across multiple chassis.</p>	
 Status LED	Off	Indicates that the module is disabled or is not powered up.
	Green	Indicates that all diagnostic tests have passed and the module is operational.  <b>Note</b> From Cisco IOS XE Cupertino 17.9.x, the Status LED on C9600X-LC-32CD and C9600-LC-40YL4CD glows darker.
	Red	Indicates major environmental alarms, if the module is online.
	Amber	Indicates minor environmental alarms, if the module is online.



LED Type	LED Position or Colour	Meaning	
 Port LED	Green	Port link is up.	
	Amber	Port link is disabled, that is, administratively down.	
	Off	No signal is detected, the link is down, or the port is not connected.	
	Alternating Green and Amber	Indicates port beacon.	
	Blinking Amber	Indicates link faults such as excessive collision, CRC errors and Jabber errors.	
	Blinking green	Indicates traffic on the port.	
		<b>Traffic Utilization</b>	<b>Blinking Rate</b>
		Less than 5%	Nil
		Between 5% and 30%	At a rate of 1.2 seconds.
		Between 30% and 70%	At a rate of 0.4 seconds.
More than 70%	At a rate of 0.2 seconds.		

## Preparing for Installation and Removal of a Line Card

### Safety Warnings

Safety warnings appear throughout this publication in procedures that may harm you if you perform them incorrectly. A warning symbol precedes each warning statement. The warnings below are general warnings that are applicable to the entire publication.



---

**Warning Statement 1071**—Warning Definition

**IMPORTANT SAFETY INSTRUCTIONS**

Before you work on any equipment, be aware of the hazards involved with electrical circuitry and be familiar with standard practices for preventing accidents. Read the installation instructions before using, installing, or connecting the system to the power source. Use the statement number at the beginning of each warning statement to locate its translation in the translated safety warnings for this device.

SAVE THESE INSTRUCTIONS



**Note** **Statement 407**—Japanese Safety Instruction

You are strongly advised to read the safety instruction before using the product.

<https://www.cisco.com/web/JP/techdoc/pldoc/pldoc.html>

When installing the product, use the provided or designated connection cables/power cables/AC adapters.

〈製品仕様における安全上の注意〉  
www.cisco.com/web/JP/techdoc/index.html

接続ケーブル、電源コードセット、ACアダプタ、バッテリーなどの部品は、必ず添付品または指定品をご使用ください。添付品・指定品以外をご使用になると故障や動作不良、火災の原因となります。また、電源コードセットは弊社が指定する製品以外の電気機器には使用できないためご注意ください。



**Warning** To reduce the risk of electric shock, the chassis of this equipment needs to be connected to permanent earth ground during normal use. **Statement 0445**



**Warning** **Statement 1008**—Class 1 Laser Product

This product is a Class 1 laser product.



**Warning** **Statement 1017**—Restricted Area

This unit is intended for installation in restricted access areas. Only skilled, instructed, or qualified personnel can access a restricted access area.



**Warning** **Statement 1029**—Blank Faceplates and Cover Panels

Blank faceplates and cover panels serve three important functions: they reduce the risk of electric shock and fire, they contain electromagnetic interference (EMI) that might disrupt other equipment, and they direct the flow of cooling air through the chassis. Do not operate the system unless all cards, faceplates, front covers, and rear covers are in place.



**Warning** **Statement 1047**—Overheating Prevention

To prevent the system from overheating, do not operate it in an area that exceeds the maximum recommended ambient temperature of 104°F (40°C).



**Warning** **Statement 1049**—Rack Installation

To reduce the risk of bodily injury, mount the chassis on a rack that is permanently affixed to the building.



---

**Warning Statement 1055—Class 1/1M Laser**

Invisible laser radiation is present. Do not expose to users of telescopic optics. This applies to Class 1/1M laser products.



---

**Warning Statement 1056—Unterminated Fiber Cable**

Invisible laser radiation may be emitted from the end of the unterminated fiber cable or connector. Do not view directly with optical instruments. Viewing the laser output with certain optical instruments, for example, eye loupes, magnifiers, and microscopes, within a distance of 100 mm, may pose an eye hazard.



---

**Warning Statement 1090—Installation by Skilled Person**

Only a skilled person should be allowed to install, replace, or service this equipment. See statement 1089 for the definition of a skilled person.

There are no serviceable parts inside. To avoid risk of electric shock, do not open.



---

**Warning Statement 1074—Comply with Local and National Electrical Codes**

To reduce risk of electric shock or fire, installation of the equipment must comply with local and national electrical codes.



---

**Warning Statement 1089—Instructed and Skilled Person Definitions**

An instructed person is someone who has been instructed and trained by a skilled person and takes the necessary precautions when working with equipment.

A skilled person or qualified personnel is someone who has training or experience in the equipment technology and understands potential hazards when working with equipment.

There are no serviceable parts inside. To avoid risk of electric shock, do not open.



---

**Warning Statement 1091—Installation by an Instructed Person**

Only an instructed person or skilled person should be allowed to install, replace, or service this equipment. See statement 1089 for the definition of an instructed or skilled person.

There are no serviceable parts inside. To avoid risk of electric shock, do not open.

---



---

**Warning Statement 1099**—Before Connecting to System Power Supply

High touch/leakage current—Permanently connected protective earth ground is essential before connecting to the system power supply.

---



---

**Warning Statement 9001**—Product Disposal

Ultimate disposal of this product should be handled according to all national laws and regulations.

---

## Preventing ESD Damage

ESD damage might occur when modules or other FRUs are improperly handled, resulting in intermittent or complete failure of the modules or FRUs. Modules consist of printed circuit boards that are fixed in metal carriers. EMI shielding and connectors are integral components of a carrier. Although the metal carrier helps to protect the board from ESD, always use an ESD-grounding strap when handling modules. To prevent ESD damage, follow these guidelines:

- Always use an ESD wrist or ankle strap and ensure that it makes good skin contact.
- Connect the equipment end of the strap to an unfinished chassis surface.
- When installing a component, use an available ejector lever to properly seat the bus connectors in the backplane or midplane. These devices prevent accidental removal, provide proper grounding for the system, and help to ensure that bus connectors are properly seated.
- When removing a component, use an available ejector lever to release the bus connectors from the backplane or midplane.
- Handle carriers by available handles or edges only; avoid touching the printed circuit boards or connectors.
- Place a removed component board-side-up on an antistatic surface or in a static-shielding container. If you plan to return the component to the factory, immediately place it in a static-shielding container.
- Avoid contact between the printed circuit boards and clothing. The wrist strap only protects components from ESD voltages on the body; ESD voltages on clothing can still cause damage.
- Never attempt to remove the printed circuit board from the metal carrier.

## Tools Required

You will need these tools to install or remove supervisor engines and line cards:

- Your own ESD-prevention equipment or the disposable grounding wrist strap included with all upgrade kits, FRUs, and spares.
- Antistatic mat or antistatic bag

## Installing and Removing Line Cards

### Installing a Line Card



---

**Caution** To prevent ESD damage, handle the line cards by the carrier edges only.

---

#### Before you begin

- Take the necessary precautions to prevent ESD damage. Wear a grounded ESD wrist strap while handling the line cards.
- Ensure that you have enough clearance to accommodate any interface equipment that you will connect directly to the ports.

#### Procedure

- 
- Step 1** Remove the slot blank cover (C9606-SLOT-BLANK=) if it is present, by squeezing the release handles towards each other (with your thumb and index fingers) and sliding the cover out of the bay. Save it for future use.
- Step 2** Remove the new line card from the shipping packaging, being careful to handle the module using only the module's metal tray or the front panel. Do not touch the printed circuit board or the connector pins.
- Step 3** Pivot the left and the right ejector levers away from the front of the module and hold them while sliding the line card into the slot.
- Step 4** Hold the line card's front panel with one hand and place your other hand under the carrier to support the line card.
- Step 5** Position and carefully slide the line card into the slot. Make sure that you align the sides of the printed circuit boards with the slot guides on each side of the chassis slot.

**Note** The ejector levers on C9600-LC-40YL4CD, C9600X-LC-32CD, and C9600X-LC-56YL4C are different from the other line cards. Ensure that you open the levers to its maximum permissible angle.

*Figure 14: Positioning and Sliding the Line Card into the Slot*

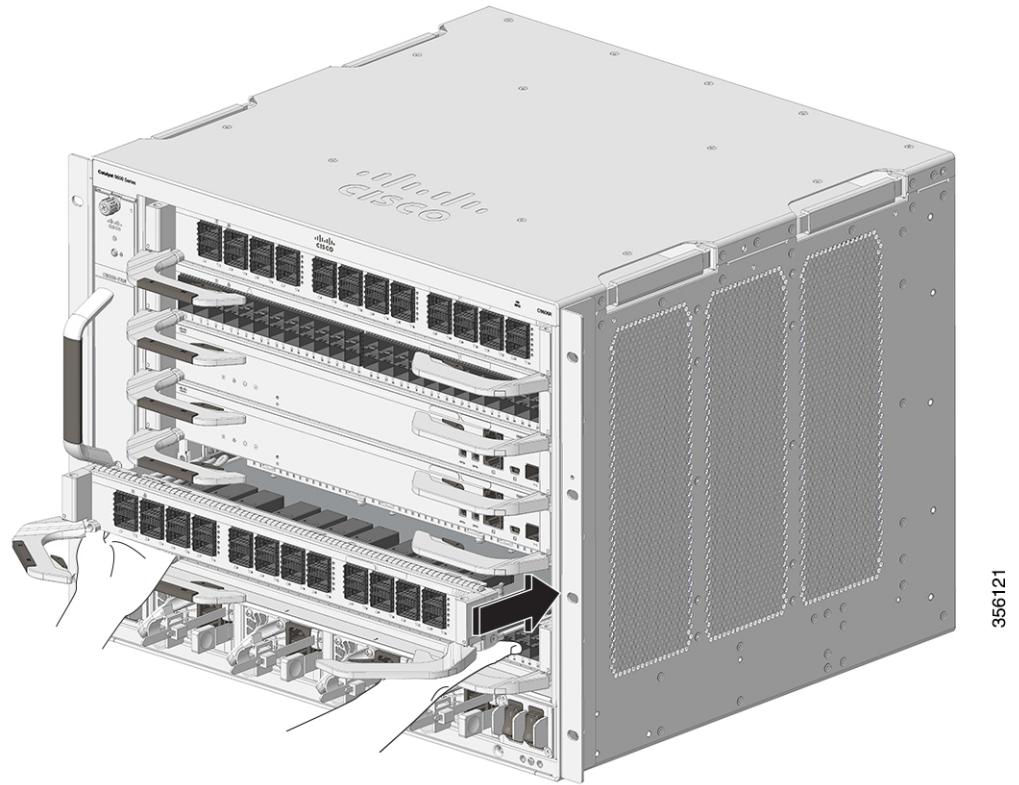

- Step 6** Pivot both the ejector levers inward simultaneously. Make sure that you pivot the ejector levers of C9600-LC-40YL4CD, C9600X-LC-32CD, and C9600X-LC-56YL4C only after the line card is seated completely inside the slot.

**Figure 15: Pivoting the Ejector Levers Inward**

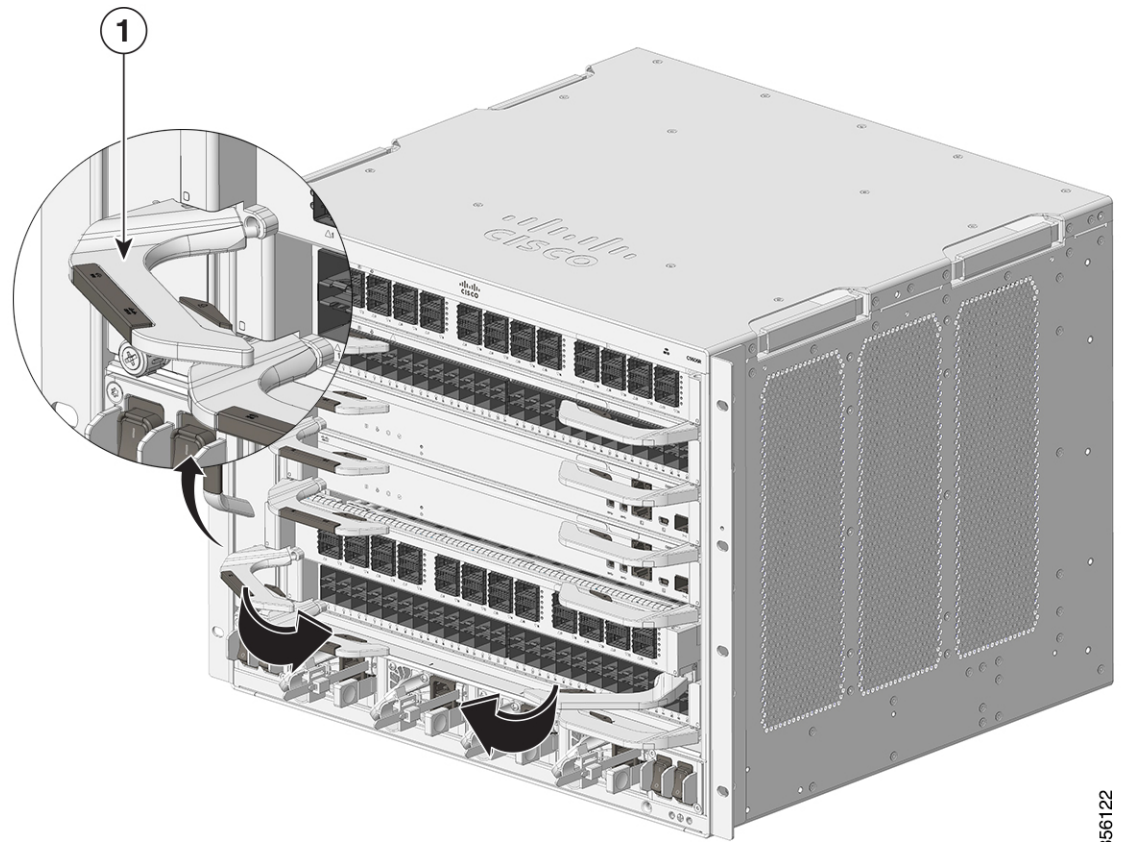

356122

**Figure 16: Pivoting the Ejector Levers of C9600-LC-40YL4CD**

The image used here is of a C9600-LC-40YL4CD. Follow similar approach for C9600X-LC-32CD and C9600X-LC-56YL4C also; the ejector levers for C9600-LC-40YL4CD, C9600X-LC-32CD, and C9600X-LC-56YL4C are similar.

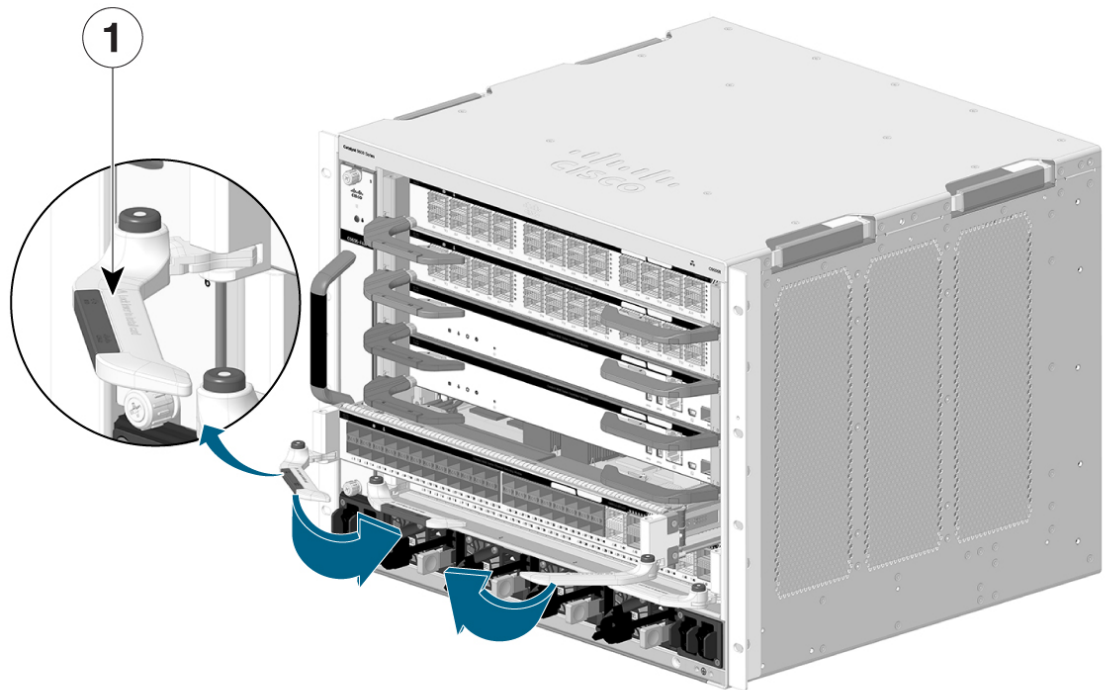

464467

1	Ejector levers	
---	----------------	--

**Step 7** Install necessary transceivers, if any, into the module ports.

For installation instructions along with safety warnings for the various types of transceivers, see [https://www.cisco.com/en/US/products/hw/modules/ps5455/prod\\_installation\\_guides\\_list.html](https://www.cisco.com/en/US/products/hw/modules/ps5455/prod_installation_guides_list.html)

**Step 8** Attach the necessary network interface cables or other devices to the interface ports.

**Step 9** Check the status of the line card:

- a) Ensure that the status LED is green.
- b) When the switch is online, enter the **show module** command. Verify that the system acknowledges the new line card and that the line card status is **OK**.
- c) If the line card is not operational, reseal it. If it is still not operational, contact your Cisco customer service representative.

## Removing a Line Card



**Warning** **Statement 1051**—Laser Radiation

Invisible laser radiation may be emitted from disconnected fibers or connectors. Do not stare into beams or view directly with optical instruments.





**Caution** To prevent ESD damage, handle line cards by the carrier edges only.

### Before you begin

- You will need a slot blank cover (C9606-SLOT-BLANK) if the slot is to remain empty.
- Take the necessary precautions to prevent ESD damage. Wear a grounded ESD wrist strap while handling the modules.

### Procedure

- Step 1** Disconnect network interface cables, if any, that are attached to the line card ports.
- Step 2** If the line card is equipped with removable optical transceivers, immediately install dust plugs into the transceiver's optical bores. This prevents possible dust contamination, which can affect port performance.
- Step 3** Grasp the left and right ejector levers and slightly push the two ejector levers in and towards the faceplate.

*Figure 17: Pushing the Ejector Levers Inward*

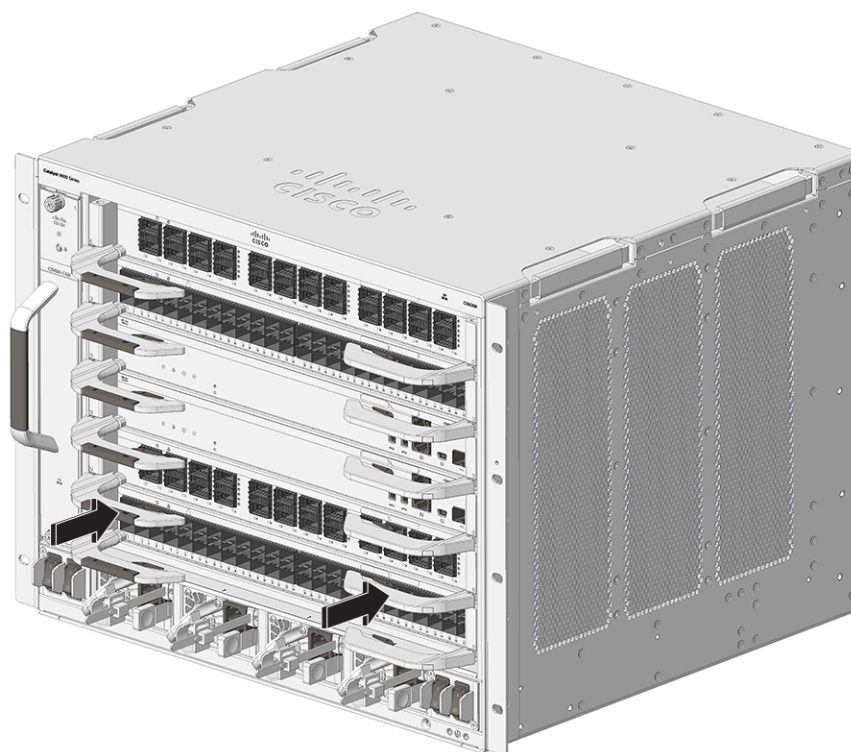

356118

**Warning** Make sure that you push the ejector levers slightly inward before you rotate the levers outward. Failing to do so will deform the injector catch pins on the levers.

- Step 4** Press the ejector buttons on the ejector levers of the line card to release the levers from the line card.

**Important** Do not press the buttons on the ejector levers of C9600-LC-40YL4CD, C9600X-LC-32CD, and C9600X-LC-56YL4C. The ejector buttons on these line cards are meant to be used only for rotating the levers while inserting transceivers or network interface cables. Pressing the button releases the ejector levers and lets you rotate the levers outward in any angle without disengaging the module from the chassis.

**Step 5** Grasp the left and right ejector levers and simultaneously rotate the levers outward to disengage the line card from the backplane connector.

**Figure 18: Pivoting the Ejector Levers**

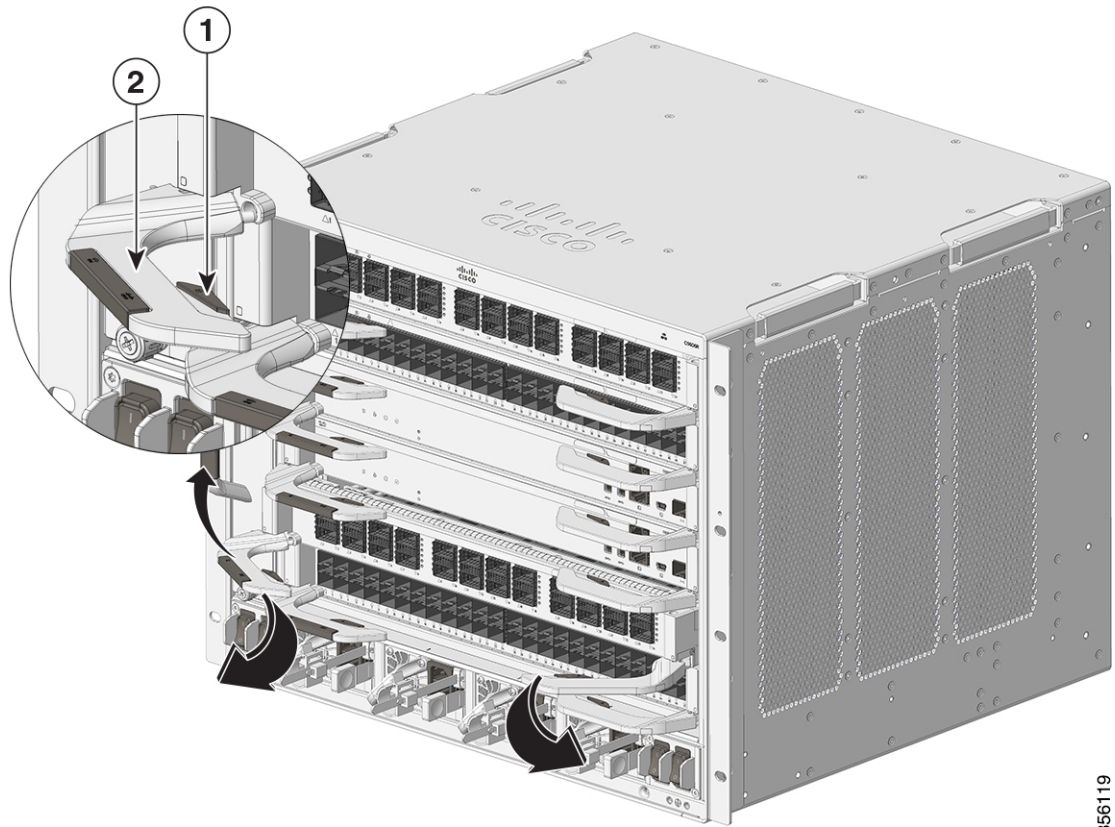

356119

**Figure 19: Pivoting the Ejector Levers on C9600-LC-40YL4CD**

The image used here is of C9600-LC-40YL4CD. Follow similar approach for C9600X-LC-32CD and C9600X-LC-56YL4C also; the ejector levers for C9600-LC-40YL4CD, C9600X-LC-32CD, and C9600X-LC-56YL4C are similar.

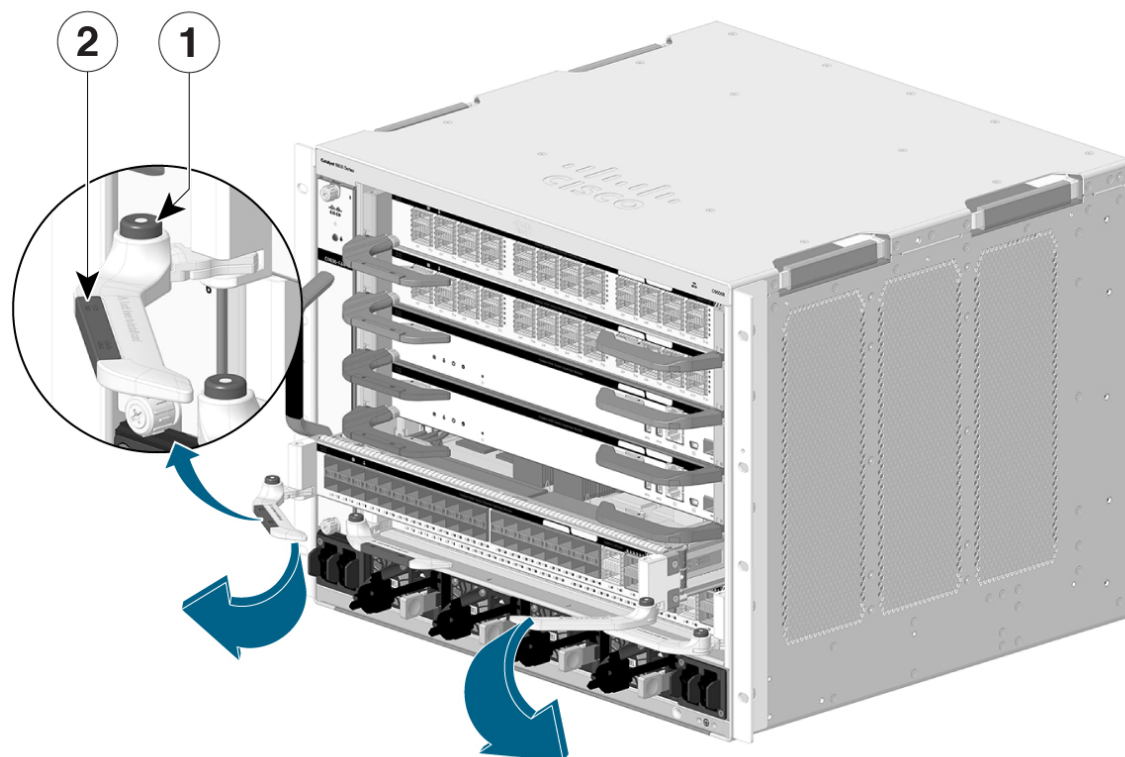

464408

1	Button on the ejector lever	2	Ejector levers
---	-----------------------------	---	----------------

**Note** The ejector buttons on C9600-LC-40YL4CD line cards are meant to be used only for rotating the levers while inserting transceivers or network interface cables. Pressing the button releases the ejector levers and lets you rotate the levers outwards in any angle without disengaging the module from the chassis.

**Step 6** Grasp the front panel of the line card with one hand and place your other hand under the carrier to support and guide it out of the slot. Do not touch the printed circuit boards or connector pins.

**Step 7** Carefully slide the line card straight out of the slot, keeping your other hand under the carrier to guide it.

Figure 20: Removing a Line Card from the Slot

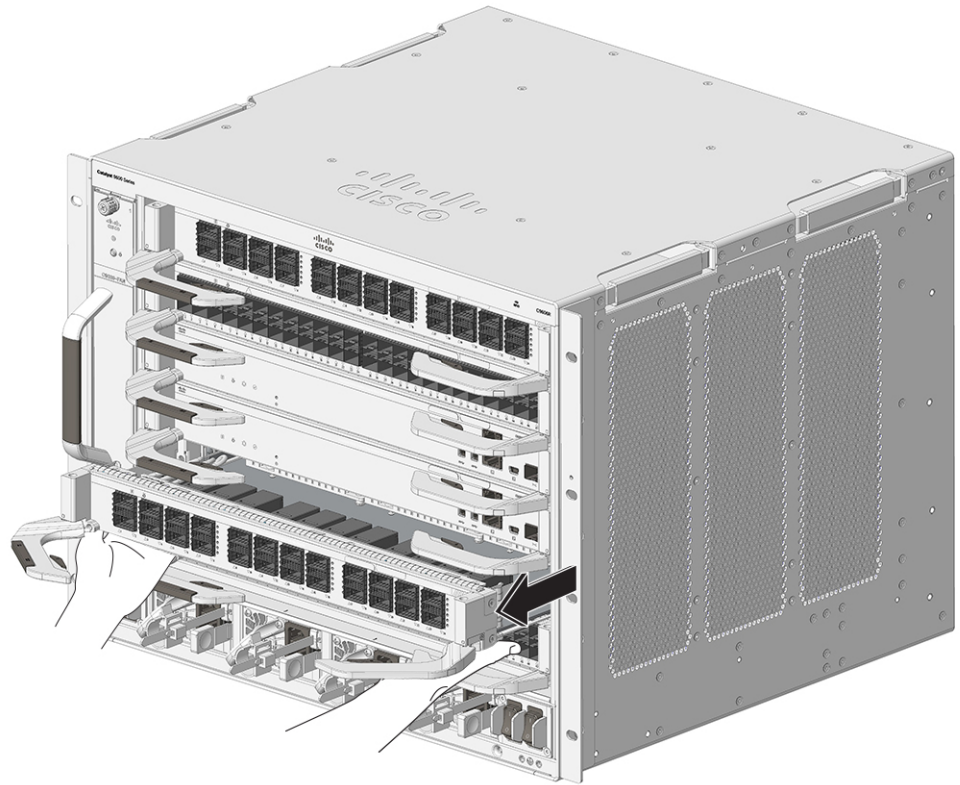

356120

**Figure 21: Removing a C9600-LC-40YL4CD from the Slot**

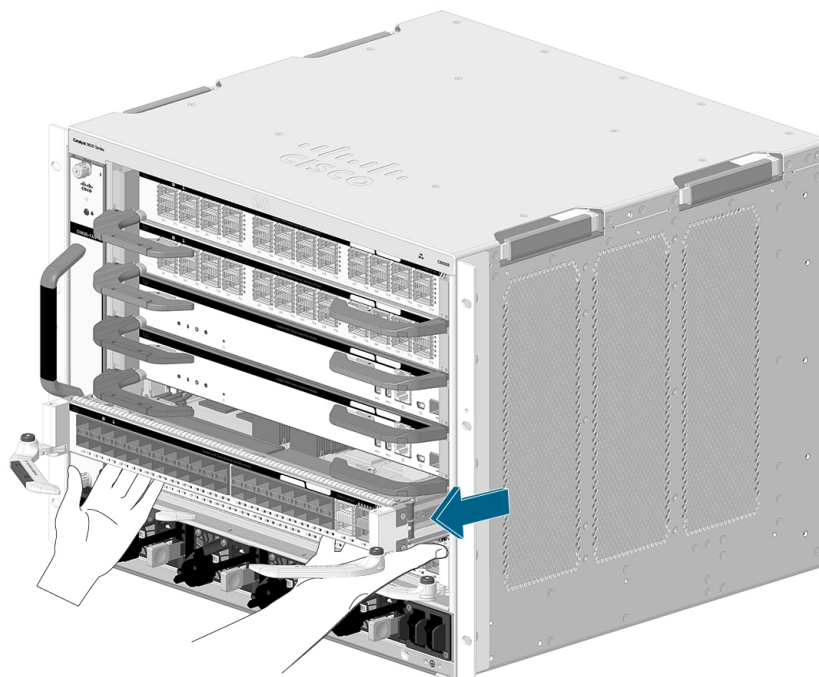

464466

**Step 8** Place the line card on an antistatic mat or in an antistatic bag.

**Step 9** Install a replacement line card after a 15-second wait. Alternatively, if the chassis slot is to remain empty, install a blank slot cover (C9606-SLOT-BLANK).

Remove slot blanks only when installing a line card. If a line card is removed, ensure that you replace it with a slot blank immediately. Also, keep the line card in ESD-protective bags when they are not installed in a chassis.

**Warning** **Statement 1029**—Blank Faceplates and Cover Panels

Blank faceplates and cover panels serve three important functions: they reduce the risk of electric shock and fire, they contain electromagnetic interference (EMI) that might disrupt other equipment, and they direct the flow of cooling air through the chassis. Do not operate the system unless all cards, faceplates, front covers, and rear covers are in place.

---

THE SPECIFICATIONS AND INFORMATION REGARDING THE PRODUCTS IN THIS MANUAL ARE SUBJECT TO CHANGE WITHOUT NOTICE. ALL STATEMENTS, INFORMATION, AND RECOMMENDATIONS IN THIS MANUAL ARE BELIEVED TO BE ACCURATE BUT ARE PRESENTED WITHOUT WARRANTY OF ANY KIND, EXPRESS OR IMPLIED. USERS MUST TAKE FULL RESPONSIBILITY FOR THEIR APPLICATION OF ANY PRODUCTS.

THE SOFTWARE LICENSE AND LIMITED WARRANTY FOR THE ACCOMPANYING PRODUCT ARE SET FORTH IN THE INFORMATION PACKET THAT SHIPPED WITH THE PRODUCT AND ARE INCORPORATED HEREIN BY THIS REFERENCE. IF YOU ARE UNABLE TO LOCATE THE SOFTWARE LICENSE OR LIMITED WARRANTY, CONTACT YOUR CISCO REPRESENTATIVE FOR A COPY.

The following information is for FCC compliance of Class A devices: This equipment has been tested and found to comply with the limits for a Class A digital device, pursuant to part 15 of the FCC rules. These limits are designed to provide reasonable protection against harmful interference when the equipment is operated in a commercial environment. This equipment generates, uses, and can radiate radio-frequency energy and, if not installed and used in accordance with the instruction manual, may cause harmful interference to radio communications. Operation of this equipment in a residential area is likely to cause harmful interference, in which case users will be required to correct the interference at their own expense.

The following information is for FCC compliance of Class B devices: This equipment has been tested and found to comply with the limits for a Class B digital device, pursuant to part 15 of the FCC rules. These limits are designed to provide reasonable protection against harmful interference in a residential installation. This equipment generates, uses and can radiate radio frequency energy and, if not installed and used in accordance with the instructions, may cause harmful interference to radio communications. However, there is no guarantee that interference will not occur in a particular installation. If the equipment causes interference to radio or television reception, which can be determined by turning the equipment off and on, users are encouraged to try to correct the interference by using one or more of the following measures:

- Reorient or relocate the receiving antenna.
- Increase the separation between the equipment and receiver.
- Connect the equipment into an outlet on a circuit different from that to which the receiver is connected.
- Consult the dealer or an experienced radio/TV technician for help.

Modifications to this product not authorized by Cisco could void the FCC approval and negate your authority to operate the product.

The Cisco implementation of TCP header compression is an adaptation of a program developed by the University of California, Berkeley (UCB) as part of UCB's public domain version of the UNIX operating system. All rights reserved. Copyright © 1981, Regents of the University of California.

NOTWITHSTANDING ANY OTHER WARRANTY HEREIN, ALL DOCUMENT FILES AND SOFTWARE OF THESE SUPPLIERS ARE PROVIDED "AS IS" WITH ALL FAULTS. CISCO AND THE ABOVE-NAMED SUPPLIERS DISCLAIM ALL WARRANTIES, EXPRESSED OR IMPLIED, INCLUDING, WITHOUT LIMITATION, THOSE OF MERCHANTABILITY, FITNESS FOR A PARTICULAR PURPOSE AND NONINFRINGEMENT OR ARISING FROM A COURSE OF DEALING, USAGE, OR TRADE PRACTICE.

IN NO EVENT SHALL CISCO OR ITS SUPPLIERS BE LIABLE FOR ANY INDIRECT, SPECIAL, CONSEQUENTIAL, OR INCIDENTAL DAMAGES, INCLUDING, WITHOUT LIMITATION, LOST PROFITS OR LOSS OR DAMAGE TO DATA ARISING OUT OF THE USE OR INABILITY TO USE THIS MANUAL, EVEN IF CISCO OR ITS SUPPLIERS HAVE BEEN ADVISED OF THE POSSIBILITY OF SUCH DAMAGES.

Any Internet Protocol (IP) addresses and phone numbers used in this document are not intended to be actual addresses and phone numbers. Any examples, command display output, network topology diagrams, and other figures included in the document are shown for illustrative purposes only. Any use of actual IP addresses or phone numbers in illustrative content is unintentional and coincidental.

All printed copies and duplicate soft copies of this document are considered uncontrolled. See the current online version for the latest version.

Cisco has more than 200 offices worldwide. Addresses and phone numbers are listed on the Cisco website at [www.cisco.com/go/offices](http://www.cisco.com/go/offices).

Cisco and the Cisco logo are trademarks or registered trademarks of Cisco and/or its affiliates in the U.S. and other countries. To view a list of Cisco trademarks, go to this URL: <https://www.cisco.com/c/en/us/about/legal/trademarks.html>. Third-party trademarks mentioned are the property of their respective owners. The use of the word partner does not imply a partnership relationship between Cisco and any other company. (1721R)

© 2019–2024 Cisco Systems, Inc. All rights reserved.