

Revised: March 19, 2024

Cisco NCS 1010 Deployment Guide, Cisco IOS XR Releases

About this Publication

This guide provides instructions for *Day-0* minimum configuration that is required to bring up Cisco NCS 1010 and associated devices into a functional state. Two approaches have been detailed:

- [Bringup NCS 1010 Manually, on page 15](#)
- [Bringup NCS 1010 Using ZTP, on page 48](#)

The approaches do not address all of the possible network needs; instead, they provide models on which you can pattern your network. You can choose not to use features presented in the examples, or you can add or substitute features that better suit your needs.

Readers must be familiar with the operating system on which the NCS 1010 runs.

Overview of the NCS 1010 Optical Line System

Optical transport networks are evolving to address an exponential increase in network traffic faced by service providers. There is a growing need to support both digital coherent optics and high-performance transponders. This release introduces a new generation of Optical Line System (OLS), the Cisco Network Convergence Series 1010 (NCS 1010).

NCS 1010 OLS platform is an integral component of Routed Optical Networking solution. It provides point-to-point connectivity between routers with ZR/ZR+ optics and multiplexes signals from multiple routers over a single fiber. The OLS platform supports ROADMs nodes of up to eight degrees using the NCS 1000 Breakout Patch Panel. NCS 1010 supports C-band WDM transmission in this release.

The NCS 1010 OLS platform provides:

- Versatility by supporting multiple coherent sources such as:
 - 400 G digital coherent ZR/ZR+ optics (-10dBm output power)
 - High-performance DCO transponders such as NCS1K4-1.2T-K9 and NCS1K4-2-QDD-C-K9 cards that use high GBaud rates.
- Simplicity by using integrated optical line cards that minimize fiber patching and cabling errors in the field.
- Automation through IOS XR operating system that provides a rich suite of automation features including Zero Touch Provisioning (ZTP), open config YANG model support with NETCONF, and streaming telemetry.
- Network monitoring through a combination of probes based on OTDR, OSC, OCM, and telemetry data.

The NCS 1010 OLS platform comprises of:

- Network Convergence System (NCS 1010) chassis
- Cisco NCS 1000 Breakout Patch Panel

- Cisco NCS 1000 32-Channel Mux/Demux Patch Panels

Cisco NCS 1010

Cisco NCS 1010 is a 3 RU modular chassis that has an in-built External Interface Timing Unit (EITU) and multiple field-replaceable modules.

NCS 1010 supports different variants of the line card:

- OLT-C Line Card: C-band Optical Line Terminal without Raman
- OLT-R-C Line Card: C-band Optical Line Terminal with Raman
- ILA-C Line Card: C-band In-Line Amplifier without Raman
- ILA-R-C Line Card: C-band In-Line Amplifier with one side Raman
- ILA-2R-C Line Card: C-band In-Line Amplifier with both sides Raman

For more information about the NCS 1010 chassis, see the [data sheet](#).

Cisco NCS 1000 Breakout Patch Panel

It is a colorless breakout patch panel that enables you to implement long-haul topologies. These topologies use high TX power transponders such as the NCS1K4-1.2T-K9 or NCS1K4-2-QDD-C-K9 line card.

The patch panel supports up to 72 mux/demux channels and eight ROADMs using the following breakout modules:

- NCS1K-BRK-8 (used as express interconnects)
- NCS1K-BRK-24 (used to colorless topology)

For more information about the NCS 1000 breakout patch panel, see the [data sheet](#).

Cisco NCS 1000 32-Channel Mux/Demux Patch Panels

These patch panels support colored channels that enable you to implement metro topologies. These topologies use low TX power modules such as 400G ZR/ZR+ coherent optics. These patch panels also support the Routed Optical Networking solution.

The two Mux/Demux patch panels (NCS1K-MD-32O-C and NCS1K-MD32E-C) support 32 channels and work as an add/drop unit for the OLT-C and OLT-R-C line cards.

For more information about the NCS 1000 Mux/Demux patch panels, see the [data sheet](#).

Hardware and Software Support

Hardware Components

The hardware components supported are:

Table 1: PIDs for Cisco NCS 1010 and Its Modules

Product ID	Product Description
NCS1010-CNTRLR-K9=	NCS 1010 Controller
NCS1010-SA	NCS 1010 Shelf Assembly
NCS1010-SYS	NCS 1010 Assemble to Order

Product ID	Product Description
NCS1010-FAN	NCS 1010 Shelf Fan Assembly
NCS1010-AC-PSU	NCS 1010 AC Power Supply Unit
NCS1010-FTF	NCS 1010 Fan Tray Filter
NCS1K-OLT-C	C-band Optical Line Terminal without Raman
NCS1K-OLT-R-C	C-band Optical Line Terminal with Raman
NCS1K-ILA-C	C-band In-Line Amplifier without Raman
NCS1K-ILA-R-C	C-band In-Line Amplifier with one side Raman
NCS1K-ILA-2R-C	C-band In-Line Amplifier with both sides Raman
NCS1K-BRK-SA	NCS 1000 breakout patch panel
NCS1K-BRK-8	8 ports colorless channels breakout module
NCS1K-BRK-24	24 ports colorless channels breakout module
NCS1K-MD-32O-C	32-channels spaced at 150 GHz on the Odd ITU grid
NCS1K-MD-32E-C	32-channels spaced at 150 GHz on the Even ITU grid

For more information about environmental specifications, see [System Environmental Specifications](#).

For more information about the power cables that are supported by the Cisco NCS 1010 AC and DC PSUs, see [Power Cable Specifications](#).

IOS-XR Software Components

Cisco IOS XR is a modern and flexible network operating system. XR improves operational efficiencies with management API integration to provide near real-time, actionable telemetry data. The two features supported are:

- **YANG-modeled management layer APIs:** To automate device provisioning and management.
- **Streaming telemetry capabilities:** For cadence-based or event-driven monitoring of data that is derived from YANG-modeled paths in the manageability layer over gRPC, TCP, or UDP.

For more information about data models and the supported YANG models, see [Data Models Configuration Guide for Cisco NCS 1010](#).

Software Support

The following features are supported on Cisco NCS 1010:

Table 2: Feature Support

Feature	Description
Multiple boot options	After installing the hardware, boot the Cisco NCS 1010 system using the pre-installed operating system (OS) image. You can connect to the XR console port and power on the system.
Zero touch provisioning	Zero touch provisioning (ZTP) allows you to provision the network device with day 0 configurations and supports both management ports and data ports.
Disaster recovery	The Disaster Recovery feature allows the CPU replacement in the field without losing the configuration and software. The traffic is not affected.
Software and FPD upgrade	You can upgrade NCS 1010 by installing a new version of the Cisco IOS XR operating system on NCS 1010.
Datapath configuration	There are four types of controllers for Cisco NCS 1010. The controllers are the OTS, OTS-OCH, OSC, and DFB controllers. You can configure and view these controllers.
Optical channel monitoring	The Optical Channel Monitor (OCM) blocks in the OLT and ILA cards provide per-channel optical power monitoring.
Performance monitoring	You can configure and retrieve PM counters for the various controllers in flex-bin, 30-second, 15-minute, or 24-hour intervals. These parameters simplify troubleshooting operations and enhance data that can be collected directly from the equipment.
Connection verification	Connection verification checks the connection between the OLT-C line card and all the other passive modules to avoid miscabling during the node installation.
ASE loading	This feature allows to completely populate the transmission spectrum at LINE-TX independent of the actual system traffic load, thereby easing the system regulation starting from the installation.
Headless mode	Cisco NCS 1010 operates in headless mode for up to 72 hours, during process restarts, controller reload, LC warm reload, LC FPD upgrade, or removal of the controller (Online Insertion and Removal (OIR)). During this time, traffic is not impacted, although the control plane is not up and running.
Passive module support	There are two types of passive controllers for Cisco NCS 1010. The controllers are the OCH and OMS controllers. You can configure and view these controllers.
Remote node management	The remote node management feature in NCS 1010 allows you to remotely manage an ILA node that is not connected to a management network through an OLT gateway node over Optical Supervisory Channel (OSC) interface. The OLT node is connected to a management network and manages ILA node remotely.
Internode topology discovery	Optical applications on the NCS 1010 nodes must discover the OLT-OLT link topology. Span level applications must discover the adjacent nodes. Link level applications must learn the complete OLT-OLT link topology. NCS 1010 uses OSPF to discover the link topology and communicate topology information.

Feature	Description
Span loss	The Span Loss calculation is an automatic calculation of span losses between NCS 1010 systems. The span loss verification algorithm calculates span loss by comparing power measurements at line Tx/Rx port at far end and line Rx/Tx port at near end.
Raman tuning	Raman Tuning Algorithm calculates and sets the different pump power values across 5 Raman pumps to obtain the target Raman Gain on a span.
Gain estimator	Gain Estimator analyses the span loss and sets the gain mode of the EDFA amplifier and provides the initial target gain for the amplifier.
Link tuner	Link tuner computes the target Power Spectral Densities (PSD) for APC by calculating the optimal PSDs for a span.
Automatic power control	Automatic Power Control (APC) corrects the power level differences and ensures that power for different channels is according to the target power profile for the spectrum. APC compensates for the degradation of the network over time. APC is enabled if automatic link bring up is enabled.
Automatic network turn up	You can bring up an NCS 1010 DWDM link without using any external tools. NCS 1010 measures optical parameters for all the spans at power-up. It then computes different setpoints for each of the spans to ensure optimal link performance for end-to-end traffic to pass through.
OTDR	An Optical Time Domain Reflectometer (OTDR) is an electronic-optical instrument that is used to characterize optical fibers. It checks defects and faults, and determines the amount of signal loss at any point in an optical fiber. The OTDR application is a built-in functionality in ILA and OLT devices.
Multi-degree support	NCS1010 OLT devices support up to 8 degrees of ROADM express. You can set up multidegree connections using NCS1K-BRK-8 modules. Use BRK-8 modules for MPO breakout for express interconnect. For a multidegree topology, you must use as many BRK-8 modules and OLT devices as there are degrees. The BRK-8 modules help NCS 1010 nodes to achieve multidegree capability.

Network Topology

The sample network topology that is shown in this section has been used to explain the manual and ZTP bringup scenarios. It is a four degree topology that uses 13 NCS 1010 nodes. The BRK-8 modules are used to create express interconnects among SITE-2, SITE-3, SITE-4, and SITE-5 using MPO cables.

Figure 1: Multi-degree Topology

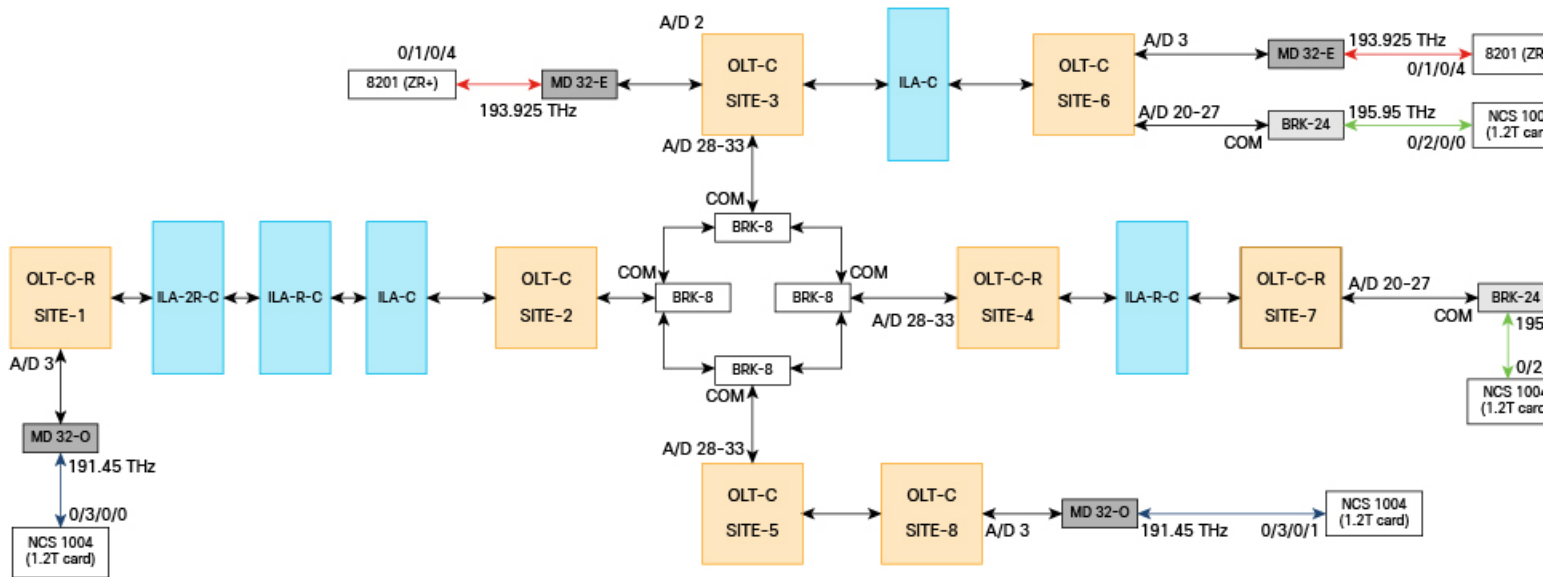

Topology Components

To build this topology, you need the following hardware:

- Cisco NCS 1010 devices
 - OLT-C (5)
 - OLT-R-C (3)
 - ILA-C (2)
 - ILA-R-C (2)
 - ILA-2R-C (1)
- NCS1K-MD32E-C modules (2)
- NCS1K-MD32O-C modules (2)
- NCS1K-BRK-8 modules (4)
- NCS1K-BRK-24 modules (2)
- Cisco 8201 routers (2)
- QDD-400G-ZR-S transceivers (2)
- NCS1K4-1.2T-K9 C-Band Line Card (4)
- LC/LC cables
- MPO cables

Create port connections as seen in the topology diagram. For more information on port connections between the devices, see [NCS 1010 Overview](#).

Hardware Installation

Before you perform any task in this publication, you must review the safety guidelines in this section to avoid injuring yourself or damaging the equipment. During any installation procedure, always use caution and common sense. For more information, see [Safety Guidelines and Warnings](#).

To install the Cisco NCS 1010 chassis and optical modules:

- [Prepare to Install Cisco NCS 1010](#)
- [Install Cisco NCS 1010](#)
- [Install Cisco NCS 1010 Modules](#)

To install the Cisco NCS 1000 Breakout Patch Panel and Modules:

- [Prepare to Install Cisco NCS 1000 Breakout Patch Panel and Modules](#)
- [Install Cisco NCS 1000 Breakout Patch Panel and Modules](#)

To install the Cisco NCS 1000 32-Channel Mux/Demux Patch Panels:

- [Prepare to Install Cisco NCS 1000 32-Channel Mux/Demux Patch Panel](#)
- [Install Cisco NCS 1000 32-Channel Mux/Demux Patch Panel](#)

To install the Cisco NCS 1004 chassis:

- [Prepare to Install Cisco NCS 1004](#)
- [Install Cisco NCS 1004](#)
- [Install Cisco NCS 1004 Modules](#)

To install the Cisco 8201 routers:

- [Hardware Installation Guide for Cisco 8200 Series Routers](#)

Bootup Process

After installing the hardware, boot the Cisco NCS 1010 system. You can connect to the XR console port and power on the system. NCS 1010 completes the boot process using the pre-installed operating system (OS) image. If no image is available, NCS 1010 can be booted using the iPXE boot or an external bootable USB drive.

Use any one of the tasks to boot the NCS 1010 chassis.

- [Boot NCS 1010 using Console](#)
- [Boot NCS 1010 Using USB Drive](#)
- [Boot Using iPXE](#)
- [Boot Using Zero Touch Provisioning](#)

The boot process using iPXE has been illustrated in the following scenarios:

- **Manual Configuration Workflow:** This workflow uses iPXE as the boot process followed by a manual bringup of the node.

- **ZTP Configuration Workflow:** This workflow uses IPXE as the boot process followed by an automated bringup of the node using ZTP configuration files.

Preliminary Checks

After you successfully log into the console, you must perform some preliminary checks to verify the default setup. If any setup issue is detected, take corrective action before making further configurations.

The following samples are verification outputs of the default setup on OLT-R-C-SITE-4 node.

Similar verification steps can be performed on all the other NCS 1010 nodes.

To verify the status of all the hardware components installed on the node, use the following command:

```
RP/0/RP0/CPU0:OLT-R-C-SITE-4#sh platform
Mon Jul 25 09:55:26.206 UTC
Node                Type                                State                                Config state
-----
0/RP0/CPU0          NCS1010-CNTRLR-K9(Active)          IOS XR RUN                          NSHUT,NMON
0/PM0               NCS1010-AC-PSU                     OPERATIONAL                          NSHUT,NMON
0/PM1               NCS1010-AC-PSU                     OFFLINE                              NSHUT,NMON
0/FT0               NCS1010-FAN                        OPERATIONAL                          NSHUT,NMON
0/FT1               NCS1010-FAN                        OPERATIONAL                          NSHUT,NMON
0/0/NXR0            NCS1K-OLT-R-C                      OPERATIONAL                          NSHUT,NMON
0/1                 NCS1K-BRK-8                        OPERATIONAL                          NSHUT,NMON
RP/0/RP0/CPU0:OLT-R-C-SITE-4#
```

To verify the inventory information for all the physical entities, use the following command:

```
RP/0/RP0/CPU0:OLT-R-C-SITE-4#sh inventory
Mon Jul 25 09:55:38.129 UTC

NAME: "Rack 0", DESCR: "NCS 1010 Shelf Assembly"
PID: NCS1010-SA , VID: V00, SN: FCB2544B0KJ

NAME: "0/RP0/CPU0", DESCR: "NCS1010 - Controller"
PID: NCS1010-CNTRLR-K9 , VID: V00, SN: FCB2541B0JE

NAME: "0/0/NXR0", DESCR: "NCS 1010 - Optical Line Terminal with Raman - C-band"
PID: NCS1K-OLT-R-C , VID: V00, SN: FCB2543B00P

NAME: "0/1", DESCR: "NCS 1000 MTP/MPO to 8 port passive breakout module"
PID: NCS1K-BRK-8 , VID: V00 , SN: MPM25381083

NAME: "0/FT0", DESCR: "NCS1010 - Shelf Fan"
PID: NCS1010-FAN , VID: V00, SN: FCB2541B0BT

NAME: "0/FT1", DESCR: "NCS1010 - Shelf Fan"
PID: NCS1010-FAN , VID: V00, SN: FCB2541B0C8

NAME: "0/PM0", DESCR: "NCS 1010 - AC Power Supply Unit"
PID: NCS1010-AC-PSU , VID: V00, SN: APS2519001X

NAME: "0/PM1", DESCR: "NCS 1010 - AC Power Supply Unit"
PID: NCS1010-AC-PSU , VID: V00, SN: APS2534009B
RP/0/RP0/CPU0:OLT-R-C-SITE-4#
```

To verify the version of Cisco IOS XR Software running on the node, use the following command:

```
RP/0/RP0/CPU0:OLT-R-C-SITE-4#sh version
Mon Jul 25 09:55:49.728 UTC
Cisco IOS XR Software, Version 7.7.1.CCO
Copyright (c) 2013-2022 by Cisco Systems, Inc.
```

Build Information:

```
Built By      : ingunawa
Built On     : Thu Jul 21 02:10:01 UTC 2022
Build Host  : iox-lnx-109
Workspace   : /auto/iox-lnx-109-s1/prod/7.7.1.CCO.IMAGE/ncs1010/ws
Version     : 7.7.1.CCO
Label      : 7.7.1.CCO
```

```
cisco NCS1010 (C3758 @ 2.20GHz)
cisco NCS1010-SA (C3758 @ 2.20GHz) processor with 32GB of memory
OLT-R-C-SITE-4 uptime is 52 minutes
NCS 1010 - Chassis
```

To verify the firmware version, use the following command:

```
RP/0/RP0/CPU0:OLT-R-C-SITE-4#sh hw-module fpd
Mon Jul 25 09:56:06.378 UTC
```

```
Auto-upgrade:Enabled
Attribute codes: B golden, P protect, S secure
```

Location	Card type	HWver	FPD device	ATR	Status	FPD Versions		Reload Loc
						Running	Programd	
0/RP0/CPU0	NCS1010-CNTLR-K9	1.0	ADMConfig		CURRENT	3.40	3.40	NOT REQ
0/RP0/CPU0	NCS1010-CNTLR-K9	1.0	BIOS	S	CURRENT	4.10	4.10	0/RP0
0/RP0/CPU0	NCS1010-CNTLR-K9	1.0	BIOS-Golden	BS	CURRENT		4.10	0/RP0
0/RP0/CPU0	NCS1010-CNTLR-K9	1.0	CpuFpga	S	CURRENT	1.02	1.02	0/RP0
0/RP0/CPU0	NCS1010-CNTLR-K9	1.0	CpuFpgaGolden	BS	CURRENT		1.01	0/RP0
0/RP0/CPU0	NCS1010-CNTLR-K9	1.0	SsdIntels4510	S	CURRENT	11.32	11.32	0/RP0
0/RP0/CPU0	NCS1010-CNTLR-K9	1.0	TamFw	S	CURRENT	6.13	6.13	0/RP0
0/RP0/CPU0	NCS1010-CNTLR-K9	1.0	TamFwGolden	BS	CURRENT		6.11	0/RP0
0/PM0	NCS1010-AC-PSU	0.0	AP-PrimMCU		CURRENT	1.03	1.03	NOT REQ
0/PM0	NCS1010-AC-PSU	0.0	AP-SecMCU		CURRENT	2.01	2.01	NOT REQ
0/PM1	NCS1010-AC-PSU	0.0	AP-PrimMCU		CURRENT	1.03	1.03	NOT REQ
0/PM1	NCS1010-AC-PSU	0.0	AP-SecMCU		CURRENT	2.01	2.01	NOT REQ
0/0/NXR0	NCS1K-OLT-R-C	1.0	OLT	S	CURRENT	1.00	1.00	NOT REQ
0/0/NXR0	NCS1K-OLT-R-C	1.0	Raman-1	S	CURRENT	1.00	1.00	NOT REQ
0/Rack	NCS1010-SA	1.0	EITU-ADMConfig		CURRENT	2.10	2.10	NOT REQ
0/Rack	NCS1010-SA	1.0	IoFpga	S	CURRENT	1.12	1.12	NOT REQ
0/Rack	NCS1010-SA	1.0	IoFpgaGolden	BS	CURRENT		1.01	NOT REQ
0/Rack	NCS1010-SA	1.0	SsdIntels4510	S	CURRENT	11.32	11.32	0/Rack

```
RP/0/RP0/CPU0:OLT-R-C-SITE-4#
```

To view the FPD image version available with this software release for each hardware component, use the following command:

```
RP/0/RP0/CPU0:OLT-R-C-SITE-4#sh fpd package
Mon Jul 25 09:56:19.911 UTC
```

Field Programmable Device Package						
Card Type	FPD Description	Req Reload	SW Ver	Min Req SW Ver	Min Req Board Ver	
NCS1010-AC-PSU	AP-PrimMCU	NO	1.03	1.03	0.0	
NCS1010-AC-PSU	AP-SecMCU	NO	2.01	2.01	0.0	
NCS1010-CNTLR-K9	ADMConfig	NO	2.30	2.30	0.0	
NCS1010-CNTLR-K9	ADMConfig	NO	2.30	2.30	0.0	
NCS1010-CNTLR-K9	ADMConfig	NO	3.40	3.40	1.0	
NCS1010-CNTLR-K9	BIOS	YES	4.10	4.10	0.0	

	BIOS	YES	4.10	4.10	0.0
	BIOS-Golden	YES	4.10	4.10	0.0
	BIOS-Golden	YES	4.10	4.10	0.0
	CpuFpga	YES	1.02	1.02	0.0
	CpuFpga	YES	1.02	1.02	0.0
	CpuFpgaGolden	YES	1.01	1.01	0.0
	CpuFpgaGolden	YES	1.01	1.01	0.0
	SsdIntelS4510	YES	11.32	11.32	0.0
	SsdIntelS4510	YES	11.32	11.32	0.0
	SsdMicron5300	YES	0.01	0.01	0.0
	SsdMicron5300	YES	0.01	0.01	0.0
	SsdSmartModular	YES	13.06	13.06	0.0
	SsdSmartModular	YES	13.06	13.06	0.0
	TamFw	YES	6.13	6.13	0.0
	TamFw	YES	6.13	6.13	0.0
	TamFwGolden	YES	6.11	6.11	0.0
	TamFwGolden	YES	6.11	6.11	0.0

NCS1010-SA	EITU-ADMConfig	NO	1.04	1.04	0.0
	EITU-ADMConfig	NO	2.10	2.10	1.0
	EITU-ADMConfig	NO	1.04	1.04	0.0
	EITU-ADMConfig	NO	2.10	2.10	1.0
	IoFpga	NO	1.12	1.12	0.0
	IoFpga	NO	1.12	1.12	0.0
	IoFpgaGolden	NO	1.01	1.01	0.0
	IoFpgaGolden	NO	1.01	1.01	0.0
	SsdIntelS4510	YES	11.32	11.32	0.0
	SsdIntelS4510	YES	11.32	11.32	0.0
	SsdMicron5300	YES	0.01	0.01	0.0
	SsdMicron5300	YES	0.01	0.01	0.0
	SsdSmartModular	YES	13.06	13.06	0.0
	SsdSmartModular	YES	13.06	13.06	0.0

NCS1K-ILA-2R-C	ILA	NO	1.00	1.00	0.1
	ILA	NO	0.23	0.23	99.1
	Raman-1	NO	1.00	1.00	0.1
	Raman-1	NO	0.23	0.23	99.1
	Raman-2	NO	1.00	1.00	0.1
	Raman-2	NO	0.23	0.23	99.1

NCS1K-ILA-C	ILA	NO	1.00	1.00	0.1
	ILA	NO	0.23	0.23	99.1

NCS1K-ILA-R-C	ILA	NO	1.00	1.00	0.1
	ILA	NO	0.23	0.23	99.1
	Raman-1	NO	1.00	1.00	0.1
	Raman-1	NO	0.23	0.23	99.1

NCS1K-OLT-C	OLT	NO	1.00	1.00	0.1
	OLT	NO	0.23	0.23	99.1

NCS1K-OLT-R-C	OLT	NO	1.00	1.00	0.1
	OLT	NO	0.23	0.23	99.1
	Raman-1	NO	1.00	1.00	0.1
	Raman-1	NO	0.23	0.23	99.1

To view the management interface status, use the following command:

```
RP/0/RP0/CPU0:OLT-R-C-SITE-4#sh interfaces mgmtEth 0/RP0/CPU0/0
Mon Jul 25 09:56:50.171 UTC
MgmtEth0/RP0/CPU0/0 is up, line protocol is up
Interface state transitions: 3
Hardware is Management Ethernet, address is 38fd.f866.071b (bia 38fd.f866.071b)
Internet address is 10.4.33.124/24
MTU 1514 bytes, BW 1000000 Kbit (Max: 1000000 Kbit)
```

```

reliability 255/255, txload 0/255, rxload 0/255
Encapsulation ARPA,
Full-duplex, 1000Mb/s, CX, link type is autonegotiation
loopback not set,
Last link flapped 00:39:48
ARP type ARPA, ARP timeout 04:00:00
Last input never, output 00:48:33
Last clearing of "show interface" counters never
5 minute input rate 0 bits/sec, 0 packets/sec
5 minute output rate 0 bits/sec, 0 packets/sec
  2180 packets input, 222691 bytes, 0 total input drops
  0 drops for unrecognized upper-level protocol
  Received 260 broadcast packets, 1916 multicast packets
    0 runts, 0 giants, 0 throttles, 0 parity
  0 input errors, 0 CRC, 0 frame, 0 overrun, 0 ignored, 0 abort
  29 packets output, 4635 bytes, 0 total output drops
  Output 5 broadcast packets, 11 multicast packets
  0 output errors, 0 underruns, 0 applique, 0 resets
  0 output buffer failures, 0 output buffers swapped out
  3 carrier transitions

```

To verify the management interface status, use the following commands:

```

RP/0/RP0/CPU0:OLT-R-C-SITE-4#sh interfaces summary
Mon Jul 25 09:57:03.639 UTC
Interface Type          Total    UP      Down    Admin Down
-----
ALL TYPES                8        5       0       3
-----
IFT_GETHERNET           1        1       0       0
IFT_LOOPBACK            1        1       0       0
IFT_ETHERNET            3        2       0       1
IFT_NULL                1        1       0       0
IFT_PTP_ETHERNET        2        0       0       2

```

```

RP/0/RP0/CPU0:OLT-R-C-SITE-4#sh interfaces brief
Mon Jul 25 09:57:14.326 UTC

```

Intf Name	Intf State	LineP State	Encap Type	MTU (byte)	BW (Kbps)
Lo0	up	up	Loopback	1500	0
Nu0	up	up	Null	1500	0
Gi0/0/0/0	up	up	ARPA	1514	1000000
Mg0/RP0/CPU0/0	up	up	ARPA	1514	1000000
Mg0/RP0/CPU0/1	admin-down	admin-down	ARPA	1514	1000000
Mg0/RP0/CPU0/2	up	up	ARPA	1514	1000000
PT0/RP0/CPU0/0	admin-down	admin-down	ARPA	1514	1000000
PT0/RP0/CPU0/1	admin-down	admin-down	ARPA	1514	1000000

```

RP/0/RP0/CPU0:OLT-R-C-SITE-4#sh ipv4 interface brief
Mon Jul 25 09:58:17.423 UTC

```

Interface	IP-Address	Status	Protocol	Vrf-Name
Loopback0	10.124.1.1	Up	Up	default
GigabitEthernet0/0/0/0	10.70.1.1	Up	Up	default
MgmtEth0/RP0/CPU0/0	10.4.33.124	Up	Up	default
PTP0/RP0/CPU0/0	unassigned	Shutdown	Down	default
MgmtEth0/RP0/CPU0/1	unassigned	Shutdown	Down	default
PTP0/RP0/CPU0/1	unassigned	Shutdown	Down	default
MgmtEth0/RP0/CPU0/2	10.127.59.153	Up	Up	default

To view the alarms, use the following command

RP/0/RP0/CPU0:OLT-R-C-SITE-4#sh alarms brief system active
 Mon Jul 25 09:58:22.288 UTC

 Active Alarms

Location	Severity	Group	Set Time	Description
0/PM1	Major	Environ	07/25/2022 09:04:20 UTC	Power Module Error (PM_VIN_VOLT_OOR)
0/PM1 (PM_OUTPUT_DISABLED)	Major	Environ	07/25/2022 09:04:20 UTC	Power Module Output Disabled
0	Major	Environ	07/25/2022 09:04:20 UTC	Power Group redundancy lost
0/0	Critical	Controller	07/25/2022 09:05:29 UTC	Ots0/0/0/1 - Loss of Signal - Payload

To view the environmental parameters, use the following commands:

RP/0/RP0/CPU0:OLT-R-C-SITE-4#sh environment fan
 Mon Jul 25 09:58:42.127 UTC

```
=====
```

Location	FRU Type	Fan speed (rpm)		
		FAN_0	FAN_1	FAN_2
0/PM0	NCS1010-AC-PSU	5280		
0/FT0	NCS1010-FAN	10020	10020	10020
0/FT1	NCS1010-FAN	10020	9960	9960

RP/0/RP0/CPU0:OLT-R-C-SITE-4#sh environment temperature location 0/RP0/CPU0
 Mon Jul 25 09:59:01.140 UTC

```
=====
```

Location	TEMPERATURE Sensor	Value (deg C)	Crit (Lo)	Major (Lo)	Minor (Lo)	Minor (Hi)	Major (Hi)	Crit (Hi)
0/RP0/CPU0	RP_TEMP_PCB	30	-10	-5	0	70	75	80
	RP_TEMP_HOT_SPOT	33	-10	-5	0	70	75	80
	RP_TEMP_LTM4638	47	-10	-5	0	80	85	90
	RP_TEMP_LTM4644_0	36	-10	-5	0	80	85	90
	RP_TEMP_LTM4644_1	39	-10	-5	0	80	85	90
	RP_JMAC_1V0_VCCP_TMON	31	-10	-5	0	80	85	90
	RP_JMAC_1V0_VNN_TMON	31	-10	-5	0	80	85	90
	RP_JMAC_1V0_VCC_RAM_TMON	32	-10	-5	0	80	85	90
	RP_JMAC_1V2_DDR_VDDQ_TMON	32	-10	-5	0	80	85	90

RP/0/RP0/CPU0:OLT-R-C-SITE-4#sh environment temperature location 0/RP0
 Mon Jul 25 09:59:05.198 UTC

```
=====
```

Location	TEMPERATURE Sensor	Value (deg C)	Crit (Lo)	Major (Lo)	Minor (Lo)	Minor (Hi)	Major (Hi)	Crit (Hi)
0/RP0/CPU0	RP_TEMP_PCB	30	-10	-5	0	70	75	80
	RP_TEMP_HOT_SPOT	33	-10	-5	0	70	75	80
	RP_TEMP_LTM4638	47	-10	-5	0	80	85	90
	RP_TEMP_LTM4644_0	36	-10	-5	0	80	85	90
	RP_TEMP_LTM4644_1	39	-10	-5	0	80	85	90
	RP_JMAC_1V0_VCCP_TMON	31	-10	-5	0	80	85	90

```

RP_JMAC_1V0_VNN_TMON          31   -10   -5    0    80    85    90
RP_JMAC_1V0_VCC_RAM_TMON      32   -10   -5    0    80    85    90
RP_JMAC_1V2_DDR_VDDQ_TMON     32   -10   -5    0    80    85    90

```

RP/0/RP0/CPU0:OLT-R-C-SITE-4#sh environment temperature location 0/0/NXR0
Mon Jul 25 09:59:22.125 UTC

```

=====
Location  TEMPERATURE          Value   Crit   Major   Minor   Minor   Major   Crit
Sensor      (deg C)   (Lo)   (Lo)   (Lo)   (Hi)   (Hi)   (Hi)
-----
0/0/NXR0
OLTC_LT_P0_iEDFA0          24     18     19     20     30     31     32
OLTC_LT_P0_iEDFA1          24     18     19     20     30     31     32
OLTC_LT_P0_iEDFA2          25     18     19     20     30     31     32
OLTC_LT_P2_iEDFA0          25     18     19     20     30     31     32
OLTC_LT_P3_iEDFA0          25     18     19     20     30     31     32
OLTC_LT_P0_eEDFA0          25     18     19     20     30     31     32
OLTC_CT_1                   29    -10     -7     -5     75     77     80
OLTC_LT_P0_eEDFA1          25     18     19     20     30     31     32
R1_CT_1                     32    -10     -7     -5     75     78     80
R1_CT_2                     32    -10     -7     -5     80     83     85
R1_CT_3                     31    -10     -7     -5     80     83     85
R1_CT_4                     33    -10     -7     -5     80     83     85
R1_LT_P0_PMP1              35     15     20     25     45     50     55
R1_LT_P0_PMP2              34     15     20     25     45     50     55
R1_LT_P0_PMP3              34     15     20     25     45     50     55
R1_LT_P0_PMP4              34     15     20     25     45     50     55
OLTC_CT_2                   26    -10     -7     -5     70     73     75
R1_LT_P0_PMP5              35     15     20     25     45     50     55
R1_LT_P0_DFB               34     15     20     25     45     50     55
OLTC_CT_3                   28    -10     -7     -5     70     73     75
OLTC_CT_4                   28    -10     -7     -5     70     73     75
OLTC_FT_P0_iEDFA0          59     55     57     58     62     64     65
OLTC_FT_P2_iEDFA0          60     55     57     58     62     64     65
OLTC_FT_P3_iEDFA0          60     55     57     58     62     64     65
OLTC_FT_P0_eEDFA0          59     55     57     58     62     64     65

```

RP/0/RP0/CPU0:OLT-R-C-SITE-4#sh environment power
Mon Jul 25 09:59:36.980 UTC

CHASSIS LEVEL POWER INFO: 0

```

=====
Total output power capacity (Group 0 + Group 1) : 1050W + 0W
Total output power required : 700W
Total power input : 184W
Total power output : 168W

```

Power Group 0:

```

=====
Power  Supply  -----Input-----  -----Output---  Status
Module  Type          Volts   Amps   Volts   Amps
-----
0/PM1   NCS1010-AC-PSU  0.0     0.0    0.0     0.0    OFFLINE

```

Total of Group 0: 0W/0.0A 0W/0.0A

Power Group 1:

```

=====
Power  Supply  -----Input-----  -----Output---  Status
Module  Type          Volts   Amps   Volts   Amps
-----
0/PM0   NCS1010-AC-PSU 230.5   0.8    12.1    13.9   OK

```

Total of Group 1: 184W/0.8A 168W/13.9A

```

=====
Location      Card Type          Power          Power          Status
Allocated    Used
Watts        Watts
=====
0/RP0/CPU0   NCS1010-CNTRLR-K9  90             16             ON
0/FT0        NCS1010-FAN        110            15             ON
0/FT1        NCS1010-FAN        110            16             ON
0/0/NXR0     NCS1K-OLT-R-C      350            87             ON
0/Rack       NCS1010-SA         40             17             ON
RP/0/RP0/CPU0:OLT-R-C-SITE-4#sh environment voltage location 0/RP0/CPU0
Mon Jul 25 09:59:55.175 UTC

```

```

=====
Location      VOLTAGE          Value          Crit          Minor          Minor          Crit
Sensor        (mV)            (Lo)          (Lo)          (Hi)          (Hi)
=====
0/RP0/CPU0
RP_ADM1266_12V0          12087         10800         11280         12720         13200
RP_ADM1266_1V8_CPU      1803          1670          1750          1850          1930
RP_ADM1266_1V24_VCCREF  1239          1150          1200          1280          1330
RP_ADM1266_1V05_CPU     1052           980          1020          1080          1120
RP_ADM1266_1V2_DDR_VDDQ 1204          1120          1160          1240          1280
RP_ADM1266_1V0_VCC_RAM  1003           650           700          1250          1300
RP_ADM1266_1V0_VNN      860           550           600          1250          1300
RP_ADM1266_1V0_VCCP     1033           450           500          1250          1300
RP_ADM1266_0V6_DDR_VTT   600           560           580           620           640
RP_ADM1266_3V3_STAND_BY 3302          3070          3200          3400          3530
RP_ADM1266_5V0          5000          4650          4850          5150          5350
RP_ADM1266_3V3          3326          3070          3200          3400          3530
RP_ADM1266_2V5_PLL      2489          2330          2430          2580          2680
RP_ADM1266_2V5_FPGA     2498          2330          2430          2580          2680
RP_ADM1266_1V2_FPGA     1202          1120          1160          1240          1280
RP_ADM1266_3V3_CPU      3326          3070          3200          3400          3530
RP_ADM1266_2V5_CPU      2507          2330          2430          2580          2680

```

```

R
RP/0/RP0/CPU0:OLT-R-C-SITE-4#sh environment current
Mon Jul 25 10:00:06.202 UTC

```

```

=====
Location      CURRENT          Value
Sensor        (mA)
=====
0/RP0/CPU0
RP_CURRMON_LTM4638          415
RP_CURRMON_LTM4644_0       179
RP_CURRMON_LTM4644_1       307
RP_JMAC_1V0_VCCP_IMON      250
RP_JMAC_1V0_VNN_IMON       93
RP_JMAC_1V0_VCC_RAM_IMON   0
RP_JMAC_1V2_DDR_VDDQ_IMON  187
0/Rack
SA_ADM1275_12V_MOD0_IMON   6608
SA_ADM1275_12V_MOD1_IMON    68
SA_ADM1275_12V_MOD2_IMON    30
SA_ADM1275_12V_FAN0_IMON  1369
SA_ADM1275_12V_FAN1_IMON  1332
SA_INA230_5V0_IMON         457
SA_INA230_3V3_IMON        1985
SA_INA230_1V0_XGE_CORE_IMON 2448
SA_INA230_1V0_FPGA_CORE_IMON 782
SA_ADM1275_12V_SA_IMON     1482
SA_ADM1275_12V_CPU_IMON    1268

```

```

RP/0/RP0/CPU0:OLT-R-C-SITE-4#sh environment altitude
Mon Jul 25 10:00:13.702 UTC

```

Location	Altitude Value (Meters)	Source
0	775	sensor

RP/0/RP0/CPU0:OLT-R-C-SITE-4#

To view the core dump context information of the node, use the following command:

```
RP/0/RP0/CPU0:OLT-R-C-SITE-4#sh context
Mon Jul 25 10:00:36.654 UTC
```

```
node: node0_RP0_CPU0
```

No context

To view the memory information, use the following command:

```
RP/0/RP0/CPU0:OLT-R-C-SITE-4#sh watchdog memory-state location all
Mon Jul 25 10:02:27.208 UTC
---- node0_RP0_CPU0 ----
Memory information:
  Physical Memory      : 31935.164 MB
  Free Memory          : 29273.921 MB
  Memory State         : Normal
```

Bringup NCS 1010

There are two approaches to bring up Cisco NCS 1010 and associated devices into a functional state:

- [Bringup NCS 1010 Manually, on page 15](#)
- [Bringup NCS 1010 Using ZTP, on page 48](#)

Bringup NCS 1010 Manually

Perform the configurations in the following sequence to manually bring up NCS 1010.

- [DHCP Configuration, on page 16](#)
- [Manual Configuration Workflow, on page 19](#)
- [Cross-connect Configuration, on page 35](#)



Note When you boot up the NCS 1010 device for the first time, the ZTP process starts automatically and runs in the background. If the device is configured manually, the ZTP process continues to run in the background. If the ZTP process is not terminated gracefully, after an RP reload or power cycle, interfaces on the device can enter the *shutdown* state. To avoid this issue, it is suggested to disable the ZTP process gracefully. Use the following commands to disable the ZTP:

```
RP/0/RP0/CPU0:ios#ztp terminate
"ZTP Exited"
RP/0/RP0/CPU0:ios#ztp clean
RP/0/RP0/CPU0:ios#ztp disable
```

DHCP Configuration

DHCP configuration is required for both manual configuration and ZTP configuration.

To run iPXE and ZTP, you need a DHCP server. To configure a DHCP server, you must edit the `dhcpd.conf` file available at `/etc/dhcp/`. This configuration file stores the network information such as the path to the script, location of the ISO install file, location of the provisioning configuration (`.cfg`) file, and serial number or the MAC address of the chassis.

In the following example, the settings in the `dhcpd.conf` refers to the span connecting OLT-R-C-SITE-1 to OLT-C-SITE-2.

Figure 2: NetworkTopology Diagram

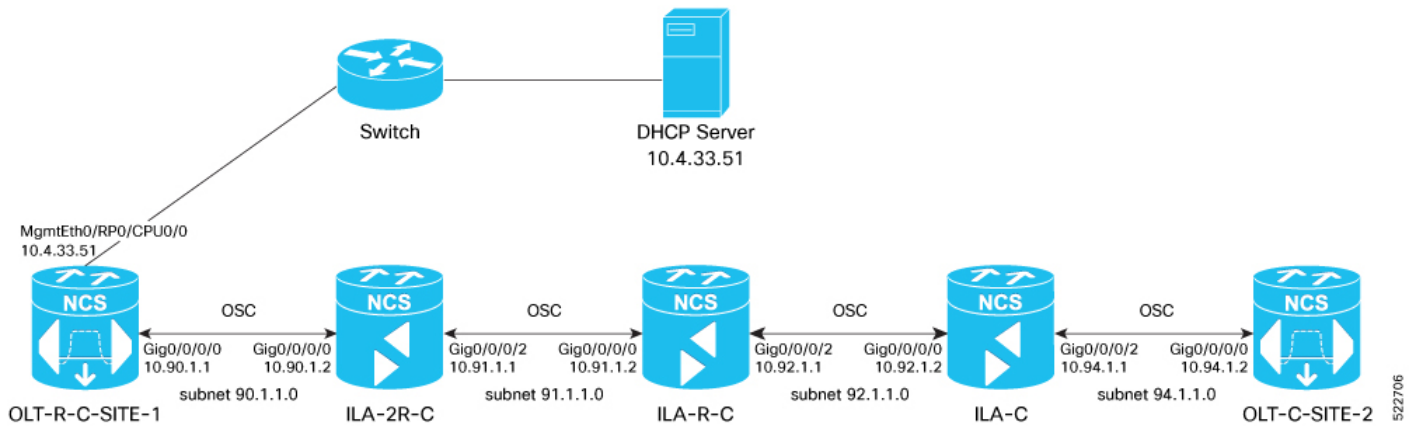

Note Restart the `dhcpd` service using the `service dhcpd restart` command every time you edit the `dhcpd.conf` file.

Add the following settings to the `dhcpd.conf` file :



Note The ZTP configuration files (`*.cfg`) that are referenced in the `dhcpd.conf` file are detailed in [ZTP Configuration Files Creation](#), on page 52.

```
# DHCP Server Configuration file
ddns-update-style none;
option domain-name "cisco.com";
option domain-name-servers dns-blr1.cisco.com;

default-lease-time 6000;
max-lease-time 72000;

log-facility local7;

option space VendorInfo;

option VendorInfo.clientId code 1 = string;

option VendorInfo.authCode code 2 = unsigned integer 8;

option VendorInfo.md5sum code 3 = string;

option vendor-specific code 43 = encapsulate VendorInfo;
```



```

option space cisco-vendor-id-vendor-class code width 1 length width 1;
option vendor-class.cisco-vendor-id-vendor-class code 9 = {string};
option bootstrap_servers code 143 = text;

ddns-update-style none;

#iPXE https specific configs
option space ipxe;
option ipxe-encap-opts code 175 = encapsulate ipxe;
option ipxe.crosscert code 93 = string;
option ipxe.crosscert "http://10.127.60.159/pub/mirror/ca.ipxe.org/auto";

#ZTP over OSC Configuration

subnet 10.90.1.0 netmask 255.255.255.0 {
    option domain-name-servers dns-blr1.cisco.com;
    option domain-name "cisco.com";
    option routers 10.90.1.1;
    #option netbios-name-serv;
}

subnet 10.91.1.0 netmask 255.255.255.0 {
    option domain-name-servers dns-blr1.cisco.com;
    option domain-name "cisco.com";
    option routers 10.91.1.1;
    #option netbios-name-serv;
}

subnet 10.92.1.0 netmask 255.255.255.0 {
    option domain-name-servers dns-blr1.cisco.com;
    option domain-name "cisco.com";
    option routers 10.92.1.1;
    #option netbios-name-serv;
}

subnet 10.94.1.0 netmask 255.255.255.0 {
    option domain-name-servers dns-blr1.cisco.com;
    option domain-name "cisco.com";
    option routers 10.94.1.1;
    #option netbios-name-serv;
}

#DHCP Relay Configuration

host OLT-R-C-SITE-1 {
    hardware ethernet 38:fd:f8:66:09:52;
    if exists user-class and option user-class = "iPXE" {
        filename "http://10.4.33.51/NCS1010/ncs1010-x64.iso";
    } else {
        filename "http://10.4.33.51/NCS1010_CFG/OLT-R-C-SITE-1.cfg";
    }
    fixed-address 10.4.33.131;
}

host ILA-2R-C {
    hardware ethernet 38:fd:f8:66:08:f6;
    fixed-address 10.90.1.2;
    if exists user-class and option user-class = "iPXE" {
        filename "http://10.4.33.51/NCS1010/ncs1010-x64.iso";
    }
}

```

```

    vendor-option-space VendorInfo;
    option VendorInfo.clientId "xr-config";
    option VendorInfo.authCode 0;
    option bootfile-name "http://10.4.33.51/NCS1010_CFG/ILA-2R-C.cfg";
}

host ILA-R-C {
hardware ethernet 38:fd:f8:66:09:f2;
fixed-address 10.91.1.2;
if exists user-class and option user-class = "iPXE" {
    filename "http://10.4.33.51/NCS1010/ncs1010-x64.iso";
}
    vendor-option-space VendorInfo;
    option VendorInfo.clientId "xr-config";
    option VendorInfo.authCode 0;
    option bootfile-name "http://10.4.33.51/NCS1010_CFG/ILA-R-C.cfg";
}

host ILA-C {
hardware ethernet 38:fd:f8:66:09:7d;
fixed-address 10.92.1.2;
if exists user-class and option user-class = "iPXE" {
    filename "http://10.4.33.51/NCS1010/ncs1010-x64.iso";
}
    vendor-option-space VendorInfo;
    option VendorInfo.clientId "xr-config";
    option VendorInfo.authCode 0;
    option bootfile-name "http://10.4.33.51/NCS1010_CFG/ILA-C.cfg";
}

host OLT-C-SITE-2 {
hardware ethernet 38:fd:f8:66:06:79;
if exists user-class and option user-class = "iPXE" {
    filename "http://10.4.33.51/NCS010/ncs1010-x64.iso";
} else {
    filename "http://10.4.33.51/NCS1010_CFG/OLT-C-SITE-2.cfg";
}
fixed-address 192.0.2.121;
}

```

To create the static routes in the DHCP server, use the following commands:

route add -net *OLT-OSC-ip* gw *OLT-MGMT-ip* netmask 255.255.255.255 dev eth3

route add -net *ILA-OSC-ip* gw *OLT-MGMT-ip* netmask 255.255.255.255 dev eth3

```

[root@vxxr-ncs1010-02 ~]# route add -net 10.90.1.1 gw 10.4.33.131 netmask 255.255.255.255 dev eth3
[root@vxxr-ncs1010-02 ~]# route add -net 10.90.1.2 gw 10.4.33.131 netmask 255.255.255.255 dev eth3
[root@vxxr-ncs1010-02 ~]# route add -net 10.91.1.1 gw 10.4.33.131 netmask 255.255.255.255 dev eth3
[root@vxxr-ncs1010-02 ~]# route add -net 10.91.1.2 gw 10.4.33.131 netmask 255.255.255.255 dev eth3
[root@vxxr-ncs1010-02 ~]# route add -net 10.92.1.1 gw 10.4.33.131 netmask 255.255.255.255 dev eth3
[root@vxxr-ncs1010-02 ~]# route add -net 10.92.1.2 gw 10.4.33.131 netmask 255.255.255.255 dev eth3
[root@vxxr-ncs1010-02 ~]# route add -net 10.94.1.1 gw 10.4.33.131 netmask 255.255.255.255 dev eth3
[root@vxxr-ncs1010-02 ~]# route add -net 10.94.1.2 gw 10.4.33.131 netmask 255.255.255.255 dev eth3

```

10.4.33.131 is the management IP address for the gateway node.

Manual Configuration Workflow

This section details how to manually bringup the nodes. Verification outputs have been added at various steps. The iPXE boot process via the BIOS interface has been used for this example.

The example used in this section is:

Figure 3: Network Topology Diagram

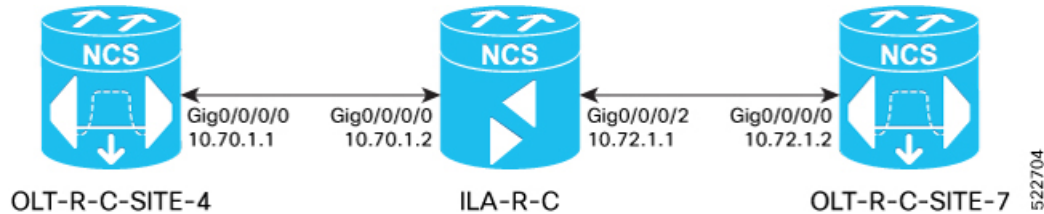

Note Before you use the iPXE boot, ensure that the DHCP server is set and is running. Create a `dhcpd.conf` file specific to the nodes in the network topology diagram. To see a sample `dhcpd.conf` file, see [DHCP Configuration, on page 16](#).

The boot process is initiated via the BIOS interface as follows:

1. The node is reloaded or can undergo a power cycle.
2. Press **Esc** to enter BIOS.
3. Select the **Save & Exit** tab of BIOS.
4. Choose **UEFI: iPXE Network Boot**.

```
Software Boot OK, Validated
```

```
iPXE initialising devices...ok
```

```
iPXE 1.0.0+ (c2215) -- Open Source Network Boot Firmware -- http://ipxe.org
Features: DNS HTTP TFTP VLAN EFI ISO9660 ISO9660_grub Menu
Trying net0-2051,net0-2052 and net0-2053...
net0-2051: 38:fd:f8:66:07:1b using NII on NII-PCI06:00.0 (open)
  [Link:down, TX:0 TXE:0 RX:0 RXE:0]
  [Link status: Unknown (http://ipxe.org/1a086194)]
Configuring (net0-2051 38:fd:f8:66:07:1b)..... ok
net0: fe80::3afd:f8ff:fe66:71b/64
net1: fe80::3afd:f8ff:fe66:71e/64 (inaccessible)
net2: fe80::3afd:f8ff:fe66:71f/64 (inaccessible)
net3: fe80::3afd:f8ff:fe66:720/64 (inaccessible)
net0-2051: 10.4.33.124/255.255.0.0 gw 10.4.33.1
net0-2051: fe80::3afd:f8ff:fe66:71b/64
net0-2051: 2002:420:54ff:93:3afd:f8ff:fe66:71b/64 gw fe80::6a9e:bff:feb8:6f4a
net0-2052: fe80::3afd:f8ff:fe66:71b/64
net0-2053: fe80::3afd:f8ff:fe66:71b/64
Filename: http://10.4.33.51/OLT4/ncs1010-x64.iso
http://10.4.33.51/OLT4/ncs1010-x64.iso... ok
Booting /EFI/BOOT/bootx64.efi
Welcome to GRUB!
```

```
Verifying (cd0)/EFI/BOOT/grub.cfg...
(cd0)/EFI/BOOT/grub.cfg verified using Pkcs7 signature.
```

```

015001H Booting `Install IOS-XR'

Booting from ISO image..
Loading Kernel..
Verifying /boot/bzImage...
/boot/bzImage verified using attached signature.
Loading initrd..
Verifying /boot/initrd.img...
/boot/initrd.img verified using Pkcs7 signature.
[ 1.989141] usbhid 1-1:1.0: couldn't find an input interrupt endpoint
2022 Jul 25 08:55:45.362 UTC: Prepare install environment
2022 Jul 25 08:55:45.365 UTC: Preparing installation environment
2022 Jul 25 08:55:45.819 UTC: Bootstrap watchdog punch start
2022 Jul 25 08:55:45.822 UTC: Wait for install device
2022 Jul 25 08:55:45.827 UTC: Create, format and mount partitions
2022 Jul 25 08:55:45.838 UTC: Creating partitions on /dev/sda
2022 Jul 25 08:55:45.867 UTC: Running disk_layout script for PID NCS1010
.
.snipped
.
.
[ OK ] Started IOS-XR ISO Installation.
[ 45.293622] xrnginstall[1292]: 2022 Jul 25 09:03:56.211 UTC: xrnginstall completed successfully
[ OK ] Started Cisco Directory Services.
Starting Lightning Fast Webserver With Light System Requirements...
[ OK ] Started Lightning Fast Webserver With Light System Requirements.
Starting NOS Bootup FPD Upgrade Service...
[ OK ] Started NOS Bootup FPD Upgrade Service.
Starting IOS-XR Reaperd and Process Manager...
[ OK ] Started IOS-XR Reaperd and Process Manager.
Starting Setting Cgroups...
[ OK ] Started Shutdown start service.
[ OK ] Started Setting Cgroups.
[ OK ] Started Kdump.
[ OK ] Reached target Multi-User System.
[ OK ] Reached target XR installation and startup.
Starting Update UTMP about System Runlevel Changes...
[ OK ] Started Update UTMP about System Runlevel Changes.

ios con0/RP0/CPU0 is now available
!!!!!!!!!!!!!!!!!!!!!! NO root-system username is configured. Need to configure root-system username.
!!!!!!!!!!!!!!!!!!!!!!

```

5. Enter a root username and password.



Note Setting the root system username and password causes the system to exit the ZTP process.

--- Administrative User Dialog ---

```

Enter root-system username:

% Entry must not be null.

Enter root-system username: cisco
Enter secret: RP/0/RP0/CPU0:Jul 25 09:08:37.522 UTC: ifmgr[234]: %PKT_INFRA-LINK-3-UPDOWN : Interface
GigabitEthernet0/0/0/0, changed state to Up
RP/0/RP0/CPU0:Jul 25 09:08:45.519 UTC: osa_driver[338]: %PKT_INFRA-FM-2-FAULT_CRITICAL : ALARM_CRITICAL
:RX-LOS-P :CLEAR :Osc0/0/0/0:

```

```

% Entry must not be null.
Enter secret:
Enter secret again:
Use the 'configure' command to modify this configuration.
User Access Verification

```

```

Username: cisco
Password:
RP/0/RP0/CPU0:ios#

```

6. Assign a hostname to the node.

```

RP/0/RP0/CPU0:ios#config
RP/0/RP0/CPU0:ios(config)#hostname OLT-R-C-SITE-4
RP/0/RP0/CPU0:ios(config)#commit
RP/0/RP0/CPU0:ios(config)#exit

```

7. View the interface status.

```

RP/0/RP0/CPU0:OLT-R-C-SITE-4#sh ipv4 interface brief
Mon Jul 25 09:14:23.072 UTC

```

Interface	IP-Address	Status	Protocol	Vrf-Name
GigabitEthernet0/0/0/0	unassigned	Shutdown	Down	default
MgmtEth0/RP0/CPU0/0	unassigned	Shutdown	Down	default
PTP0/RP0/CPU0/0	unassigned	Shutdown	Down	default
MgmtEth0/RP0/CPU0/1	unassigned	Shutdown	Down	default
PTP0/RP0/CPU0/1	unassigned	Shutdown	Down	default
MgmtEth0/RP0/CPU0/2	unassigned	Shutdown	Down	default

IP addresses must be assigned to the interfaces and the state must be changed to Up.

8. Assign IP addresses, for management, Gigabitethernet, and loopback interfaces.

```

RP/0/RP0/CPU0:OLT-R-C-SITE-4#config
Mon Jul 25 09:14:55.867 UTC
RP/0/RP0/CPU0:OLT-R-C-SITE-4(config)#interface MgmtEth 0/RP0/CPU0/0
RP/0/RP0/CPU0:OLT-R-C-SITE-4(config-if)#ipv4 address 10.4.33.124 255.255.255.0
RP/0/RP0/CPU0:OLT-R-C-SITE-4(config-if)#no shutdown
RP/0/RP0/CPU0:OLT-R-C-SITE-4(config-if)#exit
RP/0/RP0/CPU0:OLT-R-C-SITE-4(config)#interface MgmtEth 0/RP0/CPU0/2
RP/0/RP0/CPU0:OLT-R-C-SITE-4(config-if)#ipv4 address 10.127.59.153 255.255.255.0
RP/0/RP0/CPU0:OLT-R-C-SITE-4(config-if)#commit
RP/0/RP0/CPU0:OLT-R-C-SITE-4(config-if)#no shutdown
RP/0/RP0/CPU0:OLT-R-C-SITE-4(config-if)#commit
RP/0/RP0/CPU0:OLT-R-C-SITE-4(config-if)#exit
RP/0/RP0/CPU0:OLT-R-C-SITE-4#sh ipv4 interface brief
Mon Jul 25 09:17:14.247 UTC

```

Interface	IP-Address	Status	Protocol	Vrf-Name
GigabitEthernet0/0/0/0	unassigned	Shutdown	Down	default
MgmtEth0/RP0/CPU0/0	10.4.33.124	Up	Up	default
PTP0/RP0/CPU0/0	unassigned	Shutdown	Down	default
MgmtEth0/RP0/CPU0/1	unassigned	Shutdown	Down	default
PTP0/RP0/CPU0/1	unassigned	Shutdown	Down	default
MgmtEth0/RP0/CPU0/2	10.127.59.153	Up	Up	default

```

RP/0/RP0/CPU0:OLT-R-C-SITE-4#configure
Mon Jul 25 09:17:33.503 UTC
RP/0/RP0/CPU0:OLT-R-C-SITE-4(config)#interface GigabitEthernet 0/0/0/0
RP/0/RP0/CPU0:OLT-R-C-SITE-4(config-if)#ipv4 address 10.70.1.1 255.255.255.0
RP/0/RP0/CPU0:OLT-R-C-SITE-4(config-if)#exit
RP/0/RP0/CPU0:OLT-R-C-SITE-4(config)#interface loopback 0
RP/0/RP0/CPU0:OLT-R-C-SITE-4(config-if)#ipv4 address 10.124.1.1 255.255.255.255

```

```
RP/0/RP0/CPU0:OLT-R-C-SITE-4 (config-if)#commit
RP/0/RP0/CPU0:OLT-R-C-SITE-4 (config-if)#
RP/0/RP0/CPU0:OLT-R-C-SITE-4 (config-if)#end
RP/0/RP0/CPU0:OLT-R-C-SITE-4#sh ipv4 interface brief
Mon Jul 25 09:20:06.585 UTC
```

Interface	IP-Address	Status	Protocol	Vrf-Name
Loopback0	10.124.1.1	Up	Up	default
GigabitEthernet0/0/0/0	10.70.1.1	Shutdown	Down	default
MgmtEth0/RP0/CPU0/0	10.4.33.124	Up	Up	default
PTP0/RP0/CPU0/0	unassigned	Shutdown	Down	default
MgmtEth0/RP0/CPU0/1	unassigned	Shutdown	Down	default
PTP0/RP0/CPU0/1	unassigned	Shutdown	Down	default
MgmtEth0/RP0/CPU0/2	10.127.59.153	Up	Up	default

```
RP/0/RP0/CPU0:OLT-R-C-SITE-4#config
Mon Jul 25 09:20:20.669 UTC
RP/0/RP0/CPU0:OLT-R-C-SITE-4 (config)#interface GigabitEthernet 0/0/0/0
RP/0/RP0/CPU0:OLT-R-C-SITE-4 (config-if)#no shutdown
RP/0/RP0/CPU0:OLT-R-C-SITE-4 (config-if)#commit
RP/0/RP0/CPU0:OLT-R-C-SITE-4 (config-if)#end
```

```
RP/0/RP0/CPU0:OLT-R-C-SITE-4#sh ipv4 interface brief
Mon Jul 25 09:20:06.585 UTC
```

Interface	IP-Address	Status	Protocol	Vrf-Name
Loopback0	10.124.1.1	Up	Up	default
GigabitEthernet0/0/0/0	10.70.1.1	Up	Up	default
MgmtEth0/RP0/CPU0/0	10.4.33.124	Up	Up	default
PTP0/RP0/CPU0/0	unassigned	Shutdown	Down	default
MgmtEth0/RP0/CPU0/1	unassigned	Shutdown	Down	default
PTP0/RP0/CPU0/1	unassigned	Shutdown	Down	default
MgmtEth0/RP0/CPU0/2	10.127.59.153	Up	Up	default

9. Configure OSPF.

```
RP/0/RP0/CPU0:OLT-R-C-SITE-4#config
Mon Jul 25 09:20:35.600 UTC
RP/0/RP0/CPU0:OLT-R-C-SITE-4 (config)#router ospf 1
RP/0/RP0/CPU0:OLT-R-C-SITE-4 (config-ospf)#distribute link-state instance-id 0 throttle 5
RP/0/RP0/CPU0:OLT-R-C-SITE-4 (config-ospf)#router-id 10.124.1.1
RP/0/RP0/CPU0:OLT-R-C-SITE-4 (config-ospf)#network point-to-point
RP/0/RP0/CPU0:OLT-R-C-SITE-4 (config-ospf)#area 0
RP/0/RP0/CPU0:OLT-R-C-SITE-4 (config-ospf-ar)#interface loopback 0
RP/0/RP0/CPU0:OLT-R-C-SITE-4 (config-ospf-ar-if)#commit
RP/0/RP0/CPU0:OLT-R-C-SITE-4 (config-ospf-ar-if)#
RP/0/RP0/CPU0:OLT-R-C-SITE-4 (config-ospf-ar-if)#exit
RP/0/RP0/CPU0:OLT-R-C-SITE-4 (config-ospf-ar)#interface GigabitEthernet 0/0/0/0
RP/0/RP0/CPU0:OLT-R-C-SITE-4 (config-ospf-ar-if)#
RP/0/RP0/CPU0:OLT-R-C-SITE-4 (config-ospf-ar-if)#commit
RP/0/RP0/CPU0:OLT-R-C-SITE-4 (config-ospf-ar-if)#end
```

10. To view the OSPF neighbours:

```
RP/0/RP0/CPU0:OLT-R-C-SITE-4#sh ospf neighbor
Mon Jul 25 09:22:58.684 UTC
```

```
* Indicates MADJ interface
# Indicates Neighbor awaiting BFD session up
```

```
Neighbors for OSPF 1
```

Neighbor ID	Pri	State	Dead Time	Address	Interface
10.137.1.1	1	FULL/ -	00:00:38	10.70.1.2	GigabitEthernet0/0/0/0
Neighbor is up for 00:00:20					

Total neighbor count: 1



Note This output is displayed when the ILA-R-C node is brought up.

11. To view the status of the OSC controller:

```
RP/0/RP0/CPU0:OLT-R-C-SITE-4#sh controllers osc 0/0/0/0
Mon Jul 25 09:24:52.753 UTC
```

```
Controller State: Up
```

```
Transport Admin State: In Service
```

```
Laser State: On
```

```
Alarm Status:
```

```
-----
```

```
Detected Alarms: None
```

```
Alarm Statistics:
```

```
-----
```

```
RX-LOS-P = 2
```

```
TX-POWER-FAIL-LOW = 0
```

```
Parameter Statistics:
```

```
-----
```

```
Total TX Power = 0.09 dBm
```

```
Total RX Power = -17.82 dBm
```

```
Configured Parameters:
```

```
-----
```

12. To view the span loss:

```
RP/0/RP0/CPU0:OLT-R-C-SITE-4#sh olc span-loss
Mon Jul 25 09:25:09.572 UTC
```

```
Controller name           : Ots0/0/0/0
Neighbour RID             : 10.137.1.1
Apparent Rx Span Loss    : 15.9 dB
Rx Span Loss (with pumps off) : 19.2 dB
Rx Span Loss (with pumps off) measured at : 2022-07-25 09:24:37
Estimated Rx Span Loss   : NA
Apparent Tx Span Loss    : 16.0 dB
Tx Span Loss (with pumps off) : 16.8 dB
Tx Span Loss (with pumps off) measured at : 2022-07-25 09:23:12
Estimated Tx Span Loss   : NA
```



Note The optical applications such as Raman tuning, link tuner, gain estimator, and APC are disabled by default. To enable the optical applications, use the **automatic-link-bringup** as seen in the next step.

```
RP/0/RP0/CPU0:OLT-R-C-SITE-4#sh olc raman-tuning
Mon Jul 25 09:25:20.687 UTC
```

```
Controller                : Ots0/0/0/0
```

Raman-Tuning Status : **DISABLED**
Tuning Complete Timestamp : N/A
Estimated Max Possible Gain : N/A dB
Raman Gain Target : N/A dB
Gain Achieved on Tuning Complete : N/A dB

RP/0/RP0/CPU0:OLT-R-C-SITE-4#
RP/0/RP0/CPU0:OLT-R-C-SITE-4#
RP/0/RP0/CPU0:OLT-R-C-SITE-4#
RP/0/RP0/CPU0:OLT-R-C-SITE-4#sh olc apc
Mon Jul 25 09:25:39.292 UTC

Controller : Ots0/0/0/0
APC Status : **DISABLED**

RP/0/RP0/CPU0:OLT-R-C-SITE-4#sh olc link-tuner
Mon Jul 25 09:25:43.437 UTC
Controller : Ots0/0/0/0
Link Tuner Status : **DISABLED**
Last PSD computation: NA

Setpoint : Computed PSD
(dBm/12.5 GHz)

01	NaN
02	NaN
03	NaN
04	NaN
05	NaN
06	NaN
07	NaN
08	NaN
09	NaN
10	NaN
11	NaN
12	NaN
13	NaN
14	NaN
15	NaN
16	NaN
17	NaN
18	NaN
19	NaN
20	NaN
21	NaN
22	NaN
23	NaN
24	NaN
25	NaN
26	NaN
27	NaN
28	NaN
29	NaN
30	NaN
31	NaN
32	NaN
33	NaN

RP/0/RP0/CPU0:OLT-R-C-SITE-4#sh olc gain-estimator
Mon Jul 25 09:25:47.566 UTC
Controller : Ots0/0/0/0
Ingress Gain Estimator Status : **DISABLED**
Ingress Estimated Gain : NA

```
Ingress Estimated Gain Mode      : NA
RP/0/RP0/CPU0:OLT-R-C-SITE-4#
```

13. To enable automatic link bringup, use the following command:

```
RP/0/RP0/CPU0:OLT-R-C-SITE-4#config
Mon Jul 25 09:30:38.919 UTC
RP/0/RP0/CPU0:OLT-R-C-SITE-4(config)#optical-line-control
RP/0/RP0/CPU0:OLT-R-C-SITE-4(config-olc)#
RP/0/RP0/CPU0:OLT-R-C-SITE-4(config-olc)#automatic-link-bringup
RP/0/RP0/CPU0:OLT-R-C-SITE-4(config-olc)#commit
```

14. Use the following show commands to verify the state of the operations.

```
RP/0/RP0/CPU0:OLT-R-C-SITE-4#sh olc raman-tuning
Mon Jul 25 09:31:51.508 UTC
```

```
Controller          : Ots0/0/0/0
Raman-Tuning Status : WORKING - MEASUREMENT
Tuning Complete Timestamp : N/A
Estimated Max Possible Gain : N/A dB
Raman Gain Target    : N/A dB
Gain Achieved on Tuning Complete : N/A dB
```

```
RP/0/RP0/CPU0:OLT-R-C-SITE-4#sh olc apc
Mon Jul 25 09:31:56.769 UTC
```

```
Controller      : Ots0/0/0/0
APC Status      : BLOCKED
```

```
Node RID       : 10.124.1.1
Internal State  : BLOCKED
Blocked Reason  : [ AMPLI-SHUT ]
```

```
Node RID       : 10.137.1.1
Internal State  : DISCREPANCY
```

```
Node RID       : 10.129.1.1
Internal State  : DISCREPANCY
```

```
RP/0/RP0/CPU0:OLT-R-C-SITE-4#
RP/0/RP0/CPU0:OLT-R-C-SITE-4#sh alarms brief system active
Mon Jul 25 09:33:18.887 UTC
```

Active Alarms

Location	Severity	Group	Set Time	Description
----------	----------	-------	----------	-------------

0/PM1	Major	Environ	07/25/2022 09:04:20 UTC	Power Module Error (PM_VIN_VOLT_OOR)
-------	-------	---------	-------------------------	--------------------------------------

0/PM1	Major	Environ	07/25/2022 09:04:20 UTC	Power Module Output Disabled (PM_OUTPUT_DISABLED)
-------	-------	---------	-------------------------	---

0	Major	Environ	07/25/2022 09:04:20 UTC	Power Group redundancy lost
---	-------	---------	-------------------------	-----------------------------

```

0/0          Critical    Controller    07/25/2022 09:05:29 UTC    Ots0/0/0/1 - Loss of Signal -
Payload

0/0/NXR0     Minor      Software     07/25/2022 09:28:20 UTC    Ots0/0/0/0 - APC Reached
out-of-range condition in RX direction

0/0/NXR0     Major      Software     07/25/2022 09:31:37 UTC    Ots0/0/0/0 - Raman Tuning procedure
is running

0/0          Critical    Controller    07/25/2022 09:32:08 UTC    Ots0/0/0/0 - Output OTS Power
Reading Below The Fail-Low Threshold

0/0          Critical    Controller    07/25/2022 09:32:53 UTC    Ots0/0/0/1 - Output OTS Power
Reading Below The Fail-Low Threshold

RP/0/RP0/CPU0:OLT-R-C-SITE-4#sh alarms b s a | i 0/0RP/0/RP0/CPU0:Jul 25 09:33:23.520 UTC: osa_driver[338]:
%PKT_INFRA-FM-2-FAULT_CRITICAL : ALARM_CRITICAL :TX-POWER-FAIL-LOW :CLEAR :Ots0/0/0/1:
/0/0
Mon Jul 25 09:33:25.863 UTC
0/0/NXR0     Minor      Software     07/25/2022 09:28:20 UTC    Ots0/0/0/0 - APC Reached
out-of-range condition in RX direction

0/0/NXR0     Major      Software     07/25/2022 09:31:37 UTC    Ots0/0/0/0 - Raman Tuning procedure
is running

0/0          Critical    Controller    07/25/2022 09:32:08 UTC    Ots0/0/0/0 - Output OTS Power
Reading Below The Fail-Low Threshold

RP/0/RP0/CPU0:OLT-R-C-SITE-4#sh olc link-tuner
Mon Jul 25 09:33:38.414 UTC
Controller      : Ots0/0/0/0
Link Tuner Status : OPERATIONAL
Last PSD computation: 2022-07-25 09:33:13
-----
Setpoint        : Computed PSD
                  (dBm/12.5 GHz)
-----
01              -7.8
02              -7.7
03              -7.7
04              -7.7
05              -7.6
06              -7.6
07              -7.6
08              -7.5
09              -7.5
10              -7.5
11              -7.4
12              -7.4
13              -7.4
14              -7.3
15              -7.3
16              -7.3
17              -7.3
18              -7.2
19              -7.2

```

20 -7.2
21 -7.1
22 -7.1
23 -7.1
24 -7.1
25 -7.0
26 -7.0
27 -6.9
28 -6.9
29 -6.9
30 -6.9
31 -6.8
32 -6.8
33 -6.8

RP/0/RP0/CPU0:OLT-R-C-SITE-4#
RP/0/RP0/CPU0:OLT-R-C-SITE-4#sh olc gain-estimator
Mon Jul 25 09:33:45.445 UTC
Controller : Ots0/0/0/0
Ingress Gain Estimator Status : BLOCKED
Ingress Estimated Gain : NA
Ingress Estimated Gain Mode : NA
Ingress Gain Estimation Timestamp : NA

RP/0/RP0/CPU0:OLT-R-C-SITE-4#sh olc apc
Mon Jul 25 09:33:58.419 UTC

Controller : Ots0/0/0/0
APC Status : WORKING
Correcting Node : 10.124.1.1

Node RID : 10.124.1.1
Internal State : CORRECTING

Node RID : 10.137.1.1
Internal State : DISCREPANCY

Node RID : 10.129.1.1
Internal State : DISCREPANCY

RP/0/RP0/CPU0:OLT-R-C-SITE-4#sh olc raman-tuning
Mon Jul 25 09:34:03.907 UTC

Controller : Ots0/0/0/0
Raman-Tuning Status : WORKING - MEASUREMENT
Tuning Complete Timestamp : N/A
Estimated Max Possible Gain : N/A dB
Raman Gain Target : N/A dB
Gain Achieved on Tuning Complete : N/A dB

RP/0/RP0/CPU0:OLT-R-C-SITE-4#sh olc raman-tuning
Mon Jul 25 09:36:52.841 UTC

Controller : Ots0/0/0/0
Raman-Tuning Status : WORKING - CALCULATION
Tuning Complete Timestamp : N/A
Estimated Max Possible Gain : N/A dB
Raman Gain Target : 13.1 dB
Gain Achieved on Tuning Complete : N/A dB

RP/0/RP0/CPU0:OLT-R-C-SITE-4#sh olc apc

Mon Jul 25 09:37:16.073 UTC

Controller : Ots0/0/0/0
APC Status : WORKING
Correcting Node : 10.124.1.1

Node RID : 10.124.1.1
Internal State : CORRECTING

Node RID : 10.137.1.1
Internal State : DISCREPANCY

Node RID : 10.129.1.1
Internal State : DISCREPANCY

RP/0/RP0/CPU0:OLT-R-C-SITE-4#sh olc raman-tuning
Mon Jul 25 09:37:34.745 UTC

Controller : Ots0/0/0/0
Raman-Tuning Status : WORKING - CALCULATION
Tuning Complete Timestamp : N/A
Estimated Max Possible Gain : 20.6 dB
Raman Gain Target : 13.1 dB
Gain Achieved on Tuning Complete : N/A dB

RP/0/RP0/CPU0:OLT-R-C-SITE-4#
RP/0/RP0/CPU0:OLT-R-C-SITE-4#
RP/0/RP0/CPU0:OLT-R-C-SITE-4#sh olc gain-estimator
Mon Jul 25 09:40:06.404 UTC

Controller : Ots0/0/0/0
Ingress Gain Estimator Status : BLOCKED
Ingress Estimated Gain : NA
Ingress Estimated Gain Mode : NA
Ingress Gain Estimation Timestamp : NA

15. After the processes are complete, the status changes to IDLE for APC and gain estimator. The Raman tuning status changes to TUNED. The empty channels are loaded with noise by ASE.

P/0/RP0/CPU0:OLT-R-C-SITE-4#sh olc apc
Mon Jul 25 09:43:00.639 UTC

Controller : Ots0/0/0/0
APC Status : IDLE

Node RID : 10.124.1.1
Internal State : IDLE

Node RID : 10.137.1.1
Internal State : IDLE

Node RID : 10.129.1.1
Internal State : IDLE

RP/0/RP0/CPU0:OLT-R-C-SITE-4#sh olc gain-estimator
Mon Jul 25 09:45:05.539 UTC

Controller : Ots0/0/0/0
Ingress Gain Estimator Status : IDLE
Ingress Estimated Gain : 10.9 dB
Ingress Estimated Gain Mode : Normal
Ingress Gain Estimation Timestamp : 2022-07-25 09:40:12

RP/0/RP0/CPU0:OLT-R-C-SITE-4#sh olc raman-tuning
Mon Jul 25 09:45:51.487 UTC

```

Controller                : Ots0/0/0/0
Raman-Tuning Status       : TUNED
Tuning Complete Timestamp : 2022-07-25 09:40:12
Estimated Max Possible Gain : 20.6 dB
Raman Gain Target         : 13.1 dB
Gain Achieved on Tuning Complete : 13.0 dB

```

```

RP/0/RP0/CPU0:OLT-R-C-SITE-4#sh olc apc-local regulation-info controller ots 0$
Mon Jul 25 09:47:42.611 UTC
Controller                : Ots0/0/0/0
Domain Manager            : 10.129.1.1
Internal Status           : IDLE
Direction                 : RX
PSD Minimum               : -24.0 (dBm/12.5 GHz)
Gain Range                 : Normal
Last Correction           : 2022-07-25 09:43:44

```

Device Parameters	Min	Max	Configuration	Operational
Ingress Ampli Gain (dB)	10.9	23.9	16.7	16.7
Ingress Ampli Tilt (dB)	-5.0	3.4	-1.0	-0.9
RX Ampli Power (dBm)	-	25.0	-	24.3
RX VOA Attenuation (dB)	0.0	0.0	0.0	0.0
Ingress WSS/DGE Attenuation (dB)	0.0	25.0	-	-

Channel Center Current Frequency PSD (THz) (dBm/12.5 GHz)	Channel Discrepancy Width (GHz) (dB)	Channel Channel Slice ID Attn Config (dB)	Channel Source	Spectrum Slice Num	Ampli-Input PSD (dBm/12.5 GHz)	Target PSD (dBm/12.5 GHz)
191.375000	75.00	64	ASE	13	-16.5	-
-24.8	0.0	25.0				
191.449997	75.00	63	ASE	37	-16.6	-
-24.9	0.0	25.0				
191.524994	75.00	62	ASE	61	-16.6	-
-24.9	0.0	25.0				
191.600006	75.00	61	ASE	85	-16.6	-
-25.0	0.0	25.0				
191.675003	75.00	60	ASE	109	-16.7	-
-25.1	0.0	25.0				
191.750000	75.00	59	ASE	133	-16.8	-
-25.2	0.0	25.0				
191.824997	75.00	58	ASE	157	-16.9	-
-25.3	0.0	25.0				
191.899994	50.00	57	ASE	181	-16.8	-
-25.2	0.0	25.0				
191.975006	75.00	56	ASE	205	-17.0	-
-25.4	0.0	25.0				
192.050003	75.00	-	ASE	229	-17.2	-
-25.6	0.0	25.0				
192.125000	75.00	-	ASE	253	-17.2	-
-25.6	0.0	25.0				
192.199997	75.00	-	ASE	277	-17.3	-

-25.7	0.0	25.0				
192.274994	75.00	-	ASE	301	-17.3	-
-25.7	0.0	25.0				
192.350006	75.00	-	ASE	325	-17.3	-
-25.7	0.0	25.0				
192.425003	75.00	-	ASE	349	-17.5	-
-25.9	0.0	25.0				
192.500000	75.00	-	ASE	373	-17.4	-
-25.8	0.0	25.0				
192.574997	75.00	-	ASE	397	-17.7	-
-26.1	0.0	25.0				
192.649994	75.00	-	ASE	421	-17.8	-
-26.1	0.0	25.0				
192.725006	75.00	-	ASE	445	-17.7	-
-26.1	0.0	25.0				
192.800003	75.00	-	ASE	469	-17.7	-
-26.0	0.0	25.0				
192.875000	75.00	-	ASE	493	-17.8	-
-26.1	0.0	25.0				
192.949997	75.00	-	ASE	517	-17.8	-
-26.2	0.0	25.0				
193.024994	75.00	-	ASE	541	-17.9	-
-26.2	0.0	25.0				
193.100006	75.00	-	ASE	565	-18.0	-
-26.3	0.0	25.0				
193.175003	75.00	-	ASE	589	-17.8	-
-26.2	0.0	25.0				
193.250000	75.00	-	ASE	613	-17.8	-
-26.2	0.0	25.0				
193.324997	75.00	-	ASE	637	-17.9	-
-26.2	0.0	25.0				
193.399994	75.00	-	ASE	661	-17.8	-
-26.0	0.0	25.0				
193.475006	75.00	-	ASE	685	-17.6	-
-25.8	0.0	25.0				
193.550003	75.00	35	ASE	709	-17.4	-
-25.7	0.0	25.0				
193.625000	75.00	-	ASE	733	-17.2	-
-25.5	0.0	25.0				
193.699997	75.00	-	ASE	757	-17.2	-
-25.4	0.0	25.0				
193.774994	75.00	-	ASE	781	-17.1	-
-25.3	0.0	25.0				
193.850006	75.00	-	ASE	805	-17.0	-
-25.2	0.0	25.0				
193.925003	75.00	-	ASE	829	-17.0	-
-25.2	0.0	25.0				
194.000000	75.00	-	ASE	853	-17.1	-
-25.3	0.0	25.0				
194.074997	75.00	-	ASE	877	-16.9	-
-25.1	0.0	25.0				
194.149994	75.00	-	ASE	901	-17.0	-
-25.1	0.0	25.0				
194.225006	75.00	-	ASE	925	-17.1	-
-25.1	0.0	25.0				
194.300003	75.00	-	ASE	949	-17.2	-
-25.3	0.0	25.0				
194.375000	75.00	-	ASE	973	-17.3	-
-25.3	0.0	25.0				
194.449997	75.00	-	ASE	997	-17.5	-
-25.5	0.0	25.0				
194.524994	75.00	-	ASE	1021	-17.5	-
-25.5	0.0	25.0				
194.600006	75.00	-	ASE	1045	-17.7	-

-25.7	0.0	25.0					
194.675003	75.00	-	ASE	1069	-17.8	-	
-25.8	0.0	25.0					
194.750000	75.00	-	ASE	1093	-17.8	-	
-25.8	0.0	25.0					
194.824997	75.00	18	ASE	1117	-17.8	-	
-25.8	0.0	25.0					
194.899994	75.00	-	ASE	1141	-17.8	-	
-25.8	0.0	25.0					
194.975006	75.00	16	ASE	1165	-17.7	-	
-25.8	0.0	25.0					
195.050003	75.00	15	ASE	1189	-17.7	-	
-25.8	0.0	25.0					
195.125000	75.00	14	ASE	1213	-17.5	-	
-25.7	0.0	25.0					
195.199997	75.00	13	ASE	1237	-17.6	-	
-25.8	0.0	25.0					
195.274994	75.00	12	ASE	1261	-17.6	-	
-25.8	0.0	25.0					
195.350006	75.00	11	ASE	1285	-17.5	-	
-25.7	0.0	25.0					
195.425003	75.00	10	ASE	1309	-17.5	-	
-25.6	0.0	25.0					
195.500000	75.00	9	ASE	1333	-17.5	-	
-25.6	0.0	25.0					
195.574997	75.00	8	ASE	1357	-17.6	-	
-25.7	0.0	25.0					
195.649994	75.00	7	ASE	1381	-17.5	-	
-25.6	0.0	25.0					
195.725006	75.00	6	ASE	1405	-17.4	-	
-25.5	0.0	25.0					
195.800003	75.00	5	ASE	1429	-17.6	-	
-25.5	0.0	25.0					
195.875000	75.00	4	ASE	1453	-17.7	-	
-25.6	0.0	25.0					
195.949997	75.00	3	OCh	1477	-17.7	-	
-25.5	0.0	25.0					
196.024994	75.00	2	ASE	1501	-17.9	-	
-25.6	0.0	25.0					
196.100006	75.00	1	OCh	1525	-18.2	-	
-25.7	0.0	25.0					

ASE - Noise Loaded Channel
OCh - Optical Channel
RP/0/RP0/CPU0:OLT-R-C-SITE-4#sh olc span-loss
Mon Jul 25 09:51:46.279 UTC

Controller name : Ots0/0/0/0
Neighbour RID : 10.137.1.1
Apparent Rx Span Loss : 6.2 dB
Rx Span Loss (with pumps off) : 19.2 dB
Rx Span Loss (with pumps off) measured at : 2022-07-25 09:32:37
Estimated Rx Span Loss : 19.2 dB
Apparent Tx Span Loss : 4.9 dB
Tx Span Loss (with pumps off) : 16.8 dB
Tx Span Loss (with pumps off) measured at : 2022-07-25 09:23:12
Estimated Tx Span Loss : 17.0 dB

RP/0/RP0/CPU0:OLT-R-C-SITE-4#sh olc apc
Mon Jul 25 09:51:56.858 UTC

Controller : Ots0/0/0/0
APC Status : IDLE

```
Node RID      : 10.124.1.1
Internal State : IDLE
```

```
Node RID      : 10.137.1.1
Internal State : IDLE
```

```
Node RID      : 10.129.1.1
Internal State : IDLE
```

```
RP/0/RP0/CPU0:OLT-R-C-SITE-4#sh olc link-tuner
Mon Jul 25 09:52:00.272 UTC
Controller    : Ots0/0/0/0
Link Tuner Status : OPERATIONAL
Last PSD computation: 2022-07-25 09:33:13
```

```
-----
Setpoint      : Computed PSD
                (dBm/12.5 GHz)
-----
```

```
01             -7.8
02             -7.7
03             -7.7
04             -7.7
05             -7.6
06             -7.6
07             -7.6
08             -7.5
09             -7.5
10             -7.5
11             -7.4
12             -7.4
13             -7.4
14             -7.3
15             -7.3
16             -7.3
17             -7.3
18             -7.2
19             -7.2
20             -7.2
21             -7.1
22             -7.1
23             -7.1
24             -7.1
25             -7.0
26             -7.0
27             -6.9
28             -6.9
29             -6.9
30             -6.9
31             -6.8
32             -6.8
33             -6.8
```

16. Repeat steps 1 through 15 to configure the ILA-R-C and OLT-R-C-SITE-7 nodes.
17. Configure the cross-connects for the OLT-R-C-SITE-4 and OLT-R-C-SITE-7 nodes. For a sample cross-connect configuration, see [Cross-connect Configuration, on page 35](#).

The following sample displays the running configuration of the OLT-R-C-SITE-4 node that was configured earlier.

```
!! IOS XR Configuration 7.7.1.34I
!! Last configuration change at Mon Jul 25 09:31:37 2022 by cisco
!
hostname OLT-R-C-SITE-4
```



```

username cisco
  group root-lr
  group cisco-support
  secret 10
$6$apz9n/xzmQjA5n/.$1bqshQ3JznivV1890NY4e7s5ckBTzVxKk8..gz0Ms7Oe5DYNBGa4hSzKVSoi0EggK80IgBebdtXopXzU4kPSb1
!
call-home
  service active
  contact smart-licensing
  profile CiscoTAC-1
    active
    destination transport-method email disable
    destination transport-method http
!
!
interface Loopback0
  ipv4 address 10.124.1.1 255.255.255.255
!
interface MgmtEth0/RP0/CPU0/0
  ipv4 address 10.4.33.124 255.255.255.0
!
interface MgmtEth0/RP0/CPU0/1
  shutdown
!
interface MgmtEth0/RP0/CPU0/2
  ipv4 address 10.127.59.153 255.255.255.0
!
interface GigabitEthernet0/0/0/0
  ipv4 address 10.70.1.1 255.255.255.0
!
interface PTP0/RP0/CPU0/0
  shutdown
!
interface PTP0/RP0/CPU0/1
  shutdown
!
router ospf 1
  distribute link-state instance-id 0 throttle 5
  router-id 10.124.1.1
  network point-to-point
  area 0
    interface Loopback0
    !
    interface GigabitEthernet0/0/0/0
    !
!
!
optical-line-control
  automatic-link-bringup
!
end

```

The following sample displays the running configuration of the ILA-R-C node.

```

hostname ILA-R-C
username cisco
  group root-lr
  group cisco-support
  secret 10
$6$kkAus0AXCicX9s0.$eOPMOC3oIJ08yoGC6SeZR5SUyy1A2XIhloqu4BKTazw8Tmg0xccyq0p43q5UVHXMZHoNppSiX/R14WF4EZka/
password 7 05080F1C221C1F5B4A
!
call-home
  service active
  contact smart-licensing

```

```

profile CiscoTAC-1
  active
  destination transport-method email disable
  destination transport-method http
!
!
interface Loopback0
ipv4 address 10.137.1.1 255.255.255.255
!
interface MgmtEth0/RP0/CPU0/0
ipv4 address 10.4.33.137 255.255.255.0
!
interface MgmtEth0/RP0/CPU0/1
shutdown
!
interface MgmtEth0/RP0/CPU0/2
ipv4 address 10.127.59.157 255.255.255.0
!
interface GigabitEthernet0/0/0/0
ipv4 address 10.70.1.2 255.255.255.0
!
interface GigabitEthernet0/0/0/2
ipv4 address 10.72.1.1 255.255.255.0
!
interface PTP0/RP0/CPU0/0
shutdown
!
interface PTP0/RP0/CPU0/1
shutdown
!
router ospf 1
  distribute link-state instance-id 0 throttle 5
  router-id 10.137.1.1
  network point-to-point
  redistribute connected
  area 0
    interface Loopback0
    !
    interface GigabitEthernet0/0/0/0
    !
    interface GigabitEthernet0/0/0/2
    !
  optical-line-control
  automatic-link-bringup
!
End

```

The following sample displays the running configuration of the OLT-R-C-SITE-7 node.

```

hostname OLT-R-C-SITE-7
username cisco
group root-lr
group cisco-support
secret 10
$6$USjBp0rPHhgI9p0.$adQMozHZ6N8KqfHtgCFx00IcxN5F.QxezYXsoJ2IKeJx4tU/hhEmTcrEJL2z5ZlUA79CPMjdrECaTtmXBswm0s/
password 7 110A101614425A5E57
!
call-home
service active
contact smart-licensing
profile CiscoTAC-1
  active
  destination transport-method email disable

```

```

destination transport-method http
!
!
interface Loopback0
ipv4 address 10.129.1.1 255.255.255.255
!
interface MgmtEth0/RP0/CPU0/0
ipv4 address 10.4.33.127 255.255.255.0
!
interface MgmtEth0/RP0/CPU0/1
ipv4 address dhcp
shutdown
!
interface MgmtEth0/RP0/CPU0/2
ipv4 address 10.127.59.151 255.255.255.0
!
interface GigabitEthernet0/0/0/0
ipv4 address 10.72.1.2 255.255.255.0
!
interface PTP0/RP0/CPU0/0
shutdown
!
interface PTP0/RP0/CPU0/1
shutdown
!
router ospf 1
distribute link-state instance-id 0 throttle 5
router-id 10.129.1.1
network point-to-point
area 0
    interface Loopback0
    !
    interface GigabitEthernet0/0/0/0
    !
!
!
optical-line-control
automatic-link-bringup
!
end

```

Cross-connect Configuration

The OTS-OCH controllers are not created by default when the cards (NCS1K-ILA-2R-C, NCS1K-ILA-R-C, NCS1K-ILA-C, NCS1K-OLT-R-C, and NCS1K-OLT-C) are brought up. The LINE OTS-OCH controllers can be created using the **hw-module** command.

Optical Cross Connections can be configured only on OLT nodes. In these nodes, the OTS-OCH controller is not created automatically on the Add/Drop ports (COM side). The optical cross connect configuration defines the line side OTS-OCH channel as the source and creates an OTS-OCH controller on the ADD/Drop port to which the cross connection is made. The channel ID must be the same for both the LINE side and COM side OTS-OCH controller.

To illustrate the creation of the cross-connects, we are going to create a single channel from OLT-R-C-SITE-1 to OLT-C-SITE-8 in the topology diagram. The channel is mapped to **191.45 THz**.

Configuration for OLT-R-C-SITE-1

```

P/0/RP0/CPU0:OLT-R-C-SITE-1#config
Tue Jul 26 06:30:25.087 UTC
RP/0/RP0/CPU0:OLT-R-C-SITE-1(config)#hw-module location 0/0/NXR0 terminal-ampli grid-mode flex

```

```

RP/0/RP0/CPU0:OLT-R-C-SITE-1(config-hwmod-olt-flexi)#channel-id 63 centre-freq 191.45 width 75
RP/0/RP0/CPU0:OLT-R-C-SITE-1(config-hwmod-olt-flexi)#commit
Tue Jul 26 06:33:03.824 UTC
RP/0/RP0/CPU0:OLT-R-C-SITE-1(config-hwmod-olt-flexi)#end
RP/0/RP0/CPU0:OLT-R-C-SITE-1#sh hw-module location 0/0/NXR0 terminal-ampli
Tue Jul 26 06:33:13.093 UTC

```

Legend:

NXC - Channel not cross-connected
ACTIVE - Channel cross-connected to data port
ASE - Channel filled with ASE
FAILED - Data channel failed, pending transition to ASE

Location: 0/0/NXR0

Status: Provisioned

Flex Grid Info

Channel Number	Centre Frequency (THz)	Channel Width (GHz)	Channel Status
2	196.025000	75.000	ASE
17	194.900000	75.000	ACTIVE
63	191.450000	75.000	NXC

```

RP/0/RP0/CPU0:OLT-R-C-SITE-1#config
Tue Jul 26 06:33:29.885 UTC
RP/0/RP0/CPU0:OLT-R-C-SITE-1(config)#controller ots-Och 0/0/0/63
RP/0/RP0/CPU0:OLT-R-C-SITE-1(config-Ots)#add-drop-channel ots-Och 0/0/0/3/63
RP/0/RP0/CPU0:OLT-R-C-SITE-1(config-Ots)#commit
RP/0/RP0/CPU0:OLT-R-C-SITE-1(config-Ots)#end
RP/0/RP0/CPU0:OLT-R-C-SITE-1#sh hw-module location 0/0/NXR0 terminal-ampli
Tue Jul 26 06:34:27.110 UTC

```

Legend:

NXC - Channel not cross-connected
ACTIVE - Channel cross-connected to data port
ASE - Channel filled with ASE
FAILED - Data channel failed, pending transition to ASE

Location: 0/0/NXR0

Status: Provisioned

Flex Grid Info

Channel Number	Centre Frequency (THz)	Channel Width (GHz)	Channel Status
2	196.025000	75.000	ASE
17	194.900000	75.000	ACTIVE
63	191.450000	75.000	ACTIVE

Configuration for ILA-2R-C

```

RP/0/RP0/CPU0:ILA-2R-C#config
Tue Jul 26 06:35:12.145 UTC
RP/0/RP0/CPU0:ILA-2R-C(config)#hw-module location 0/0/NXR0 inline-ampli
RP/0/RP0/CPU0:ILA-2R-C(config-hwmod-ila)#grid-mode flex
RP/0/RP0/CPU0:ILA-2R-C(config-hwmod-ila-flexi)#channel-id 63 centre-freq 191.45 width 75
RP/0/RP0/CPU0:ILA-2R-C(config-hwmod-ila-flexi)#commit
RP/0/RP0/CPU0:ILA-2R-C(config-hwmod-ila-flexi)#end
RP/0/RP0/CPU0:ILA-2R-C#sh hw-module location 0/0/NXR0 inline-ampli
Tue Jul 26 06:36:33.333 UTC

```

Location: 0/0/NXR0

Status: Provisioned

Flex Grid Info

Channel Number	Centre Frequency (THz)	Channel Width (GHz)
63	191.450000	75.000

RP/0/RP0/CPU0:ILA-2R-C#sh controllers ots-Och 0/0/0/63
 Tue Jul 26 06:36:41.935 UTC

Controller State: Up

Transport Admin State: In Service

Alarm Status:

Detected Alarms: None

Parameter Statistics:

Total RX Power = -13.40 dBm
Total TX Power = 0.99 dBm

Configured Parameters:

RP/0/RP0/CPU0:ILA-2R-C#sh controllers ots-Och 0/0/0/2/63
 Tue Jul 26 06:36:52.466 UTC

Controller State: Up

Transport Admin State: In Service

Alarm Status:

Detected Alarms: None

Parameter Statistics:

Total RX Power = -5.50 dBm
Total TX Power = 2.29 dBm

Configured Parameters:

Configuration for ILA-R-C

```
RP/0/RP0/CPU0:ILA-R-C#config
Tue Jul 26 06:36:45.377 UTC
RP/0/RP0/CPU0:ILA-R-C(config)#hw-module location 0/0/NXR0 inline-ampli grid-mode flex
RP/0/RP0/CPU0:ILA-R-C(config-hwmod-ila-flexi)#channel-id 63 centre-freq 191.45 width 75
RP/0/RP0/CPU0:ILA-R-C(config-hwmod-ila-flexi)#commit
RP/0/RP0/CPU0:ILA-R-C(config-hwmod-ila-flexi)#end
RP/0/RP0/CPU0:ILA-R-C#sh hw-module location 0/0/NXR0 inline-ampli
Tue Jul 26 06:37:08.127 UTC
```

Location: 0/0/NXR0

Status: Provisioned

Flex Grid Info

Channel Number	Centre Frequency (THz)	Channel Width (GHz)
63	191.450000	75.000

RP/0/RP0/CPU0:ILA-R-C#sh controllers ots-Och 0/0/0/0/63
Tue Jul 26 07:08:07.280 UTC

Controller State: Up

Transport Admin State: In Service

Alarm Status:

Detected Alarms: None

Parameter Statistics:

Total RX Power = -12.40 dBm

Total TX Power = 1.19 dBm

Configured Parameters:

RP/0/RP0/CPU0:ILA-R-C#sh controllers ots-Och 0/0/0/2/63
Tue Jul 26 07:08:10.854 UTC

Controller State: Up

Transport Admin State: In Service

Alarm Status:

Detected Alarms: None

Parameter Statistics:

Total RX Power = -9.10 dBm

Total TX Power = 1.39 dBm

Configured Parameters:

Configuration for ILA-C

RP/0/RP0/CPU0:ILA-C#config

Tue Jul 26 06:38:56.584 UTC

RP/0/RP0/CPU0:ILA-C(config)#hw-module location 0/0/NXR0 inline-ampli grid-mode flex

RP/0/RP0/CPU0:ILA-C(config-hwmod-ila-flexi)#channel-id 63 centre-freq 191.45 width 75

RP/0/RP0/CPU0:ILA-C(config-hwmod-ila-flexi)#commit

Tue Jul 26 06:39:24.378 UTC

RP/0/RP0/CPU0:ILA-C(config-hwmod-ila-flexi)#end

RP/0/RP0/CPU0:ILA-C#

RP/0/RP0/CPU0:ILA-C#sh hw-module location 0/0/NXR0 inline-ampli

Tue Jul 26 06:39:43.874 UTC

Location: 0/0/NXR0

Status: Provisioned

Flex Grid Info

Channel Number	Centre Frequency (THz)	Channel Width (GHz)
63	191.450000	75.000

RP/0/RP0/CPU0:ILA-C#sh controllers ots-Och 0/0/0/0/63
Tue Jul 26 07:10:32.333 UTC

Controller State: Up

Transport Admin State: In Service

Alarm Status:

Detected Alarms: None

Parameter Statistics:

Total RX Power = -15.80 dBm

Total TX Power = -0.60 dBm

Configured Parameters:

RP/0/RP0/CPU0:ILA-C#sh controllers ots-Och 0/0/0/2/63
Tue Jul 26 07:10:38.238 UTC

Controller State: Up

Transport Admin State: In Service

Alarm Status:

Detected Alarms: None

Parameter Statistics:

Total RX Power = -11.00 dBm

Total TX Power = -1.60 dBm

Configured Parameters:

Configuration for OLT-C-SITE-2

RP/0/RP0/CPU0:OLT-C-SITE-2#config

Tue Jul 26 06:38:54.139 UTC

RP/0/RP0/CPU0:OLT-C-SITE-2(config)#hw-module location 0/0/NXR0 terminal-ampli

RP/0/RP0/CPU0:OLT-C-SITE-2(config-hwmod-olt)#grid-mode flex

RP/0/RP0/CPU0:OLT-C-SITE-2(config-hwmod-olt-flexi)#channel-id 63 centre-freq 191.45 width 75

RP/0/RP0/CPU0:OLT-C-SITE-2(config-hwmod-olt-flexi)#commit

RP/0/RP0/CPU0:OLT-C-SITE-2(config-hwmod-olt-flexi)#end

RP/0/RP0/CPU0:OLT-C-SITE-2#sh hw-module location 0/0/NXR0 terminal-ampli

Tue Jul 26 06:39:23.878 UTC

Legend:

NXC - Channel not cross-connected

ACTIVE - Channel cross-connected to data port

ASE - Channel filled with ASE

FAILED - Data channel failed, pending transition to ASE

Location: 0/0/NXR0

Status: Provisioned

Flex Grid Info

Channel Number	Centre Frequency (THz)	Channel Width (GHz)	Channel Status
2	196.025000	75.000	ASE
17	194.900000	75.000	ACTIVE
63	191.450000	75.000	NXC

```
RP/0/RP0/CPU0:OLT-C-SITE-2#config
Tue Jul 26 06:48:25.732 UTC
RP/0/RP0/CPU0:OLT-C-SITE-2(config)#controller ots-Och 0/0/0/0/63
RP/0/RP0/CPU0:OLT-C-SITE-2(config-Ots)#add-drop-channel ots-Och 0/0/0/30/63
RP/0/RP0/CPU0:OLT-C-SITE-2(config-Ots)#commit
RP/0/RP0/CPU0:OLT-C-SITE-2(config-Ots)#end
RP/0/RP0/CPU0:OLT-C-SITE-2#sh controllers ots-Och 0/0/0/0/63
Tue Jul 26 07:10:28.928 UTC
```

Controller State: Up

Transport Admin State: In Service

Alarm Status:

Detected Alarms: None

Parameter Statistics:

Total RX Power = -11.80 dBm
Total TX Power = 0.99 dBm

Cross Connect Info:

Add-Drop Channel = Ots-Och0/0/0/30/63

Configured Parameters:

```
RP/0/RP0/CPU0:OLT-C-SITE-2#sh controllers ots-Och 0/0/0/30/63
Tue Jul 26 07:10:33.899 UTC
```

Controller State: Up

Transport Admin State: In Service

Alarm Status:

Detected Alarms: None

Parameter Statistics:

Total RX Power = -4.50 dBm
Total TX Power = -2.20 dBm

Cross Connect Info:

line Channel = Ots-Och0/0/0/0/63

Configured Parameters:

Configuration for OLT-C-SITE-5

```
RP/0/RP0/CPU0:OLT-C-SITE-5#config
Tue Jul 26 06:50:27.739 UTC
Current Configuration Session Line      User      Date      Lock
00001000-000044b2-00000000      con0_RP0_C cisco     Fri Jul 22 11:53:12 2022
RP/0/RP0/CPU0:OLT-C-SITE-5(config)#hw-module location 0/0/NXR0 terminal-ampli grid-mode flex
RP/0/RP0/CPU0:OLT-C-SITE-5(config-hwmod-olt-flexi)#channel-id 63 centre-freq 191.45 width 75
RP/0/RP0/CPU0:OLT-C-SITE-5(config-hwmod-olt-flexi)#commit
Tue Jul 26 06:50:54.786 UTC
RP/0/RP0/CPU0:OLT-C-SITE-5(config-hwmod-olt-flexi)#end
RP/0/RP0/CPU0:OLT-C-SITE-5#sh hw-module location 0/0/NXR0 terminal-ampli
Tue Jul 26 06:51:01.966 UTC
```

Legend:

NXC - Channel not cross-connected
ACTIVE - Channel cross-connected to data port
ASE - Channel filled with ASE
FAILED - Data channel failed, pending transition to ASE

Location: 0/0/NXR0

Status: Provisioned

Flex Grid Info

Channel Number	Centre Frequency (THz)	Channel Width (GHz)	Channel Status
1	196.100000	75.000	ACTIVE
3	195.950000	75.000	ASE
5	195.800000	75.000	ASE
17	194.900000	75.000	ACTIVE
59	191.750000	75.000	ACTIVE
61	191.600000	75.000	ACTIVE
62	191.525000	75.000	ASE
63	191.450000	75.000	NXC
64	191.375000	75.000	ACTIVE

```
RP/0/RP0/CPU0:OLT-C-SITE-5#config
Tue Jul 26 06:51:05.833 UTC
Current Configuration Session Line      User      Date      Lock
00001000-000044b2-00000000      con0_RP0_C cisco     Fri Jul 22 11:53:12 2022
RP/0/RP0/CPU0:OLT-C-SITE-5(config)#controller ots-Och 0/0/0/0/63
RP/0/RP0/CPU0:OLT-C-SITE-5(config-Ots)#add-drop-channel ots-Och 0/0/0/30/63
RP/0/RP0/CPU0:OLT-C-SITE-5(config-Ots)#commit
RP/0/RP0/CPU0:OLT-C-SITE-5(config-Ots)#end
RP/0/RP0/CPU0:OLT-C-SITE-5#
RP/0/RP0/CPU0:OLT-C-SITE-5#sh controllers ots-Och 0/0/0/0/63
Tue Jul 26 07:12:50.904 UTC
```

Controller State: Up

Transport Admin State: In Service

Alarm Status:

Detected Alarms: None

Parameter Statistics:

Total RX Power = -11.00 dBm

Total TX Power = 1.89 dBm

Cross Connect Info:

Add-Drop Channel = Ots-Och0/0/0/30/63

Configured Parameters:

RP/0/RP0/CPU0:OLT-C-SITE-5#sh controllers ots-Och 0/0/0/30/63
Tue Jul 26 07:12:54.871 UTC

Controller State: Up

Transport Admin State: In Service

Alarm Status:

Detected Alarms: None

Parameter Statistics:

Total RX Power = -3.70 dBm
Total TX Power = -2.70 dBm

Cross Connect Info:

line Channel = Ots-Och0/0/0/0/63

Configured Parameters:

Configuration for OLT-C-SITE-8

```
RP/0/RP0/CPU0:OLT-C-SITE-8#config
Tue Jul 26 06:56:26.764 UTC
Current Configuration Session Line User Date Lock
00001000-0000345b-00000000 con0_RP0_C cisco Fri Jul 22 11:54:38 2022
RP/0/RP0/CPU0:OLT-C-SITE-8(config)#controller ots-Och 0/0/0/0/63
RP/0/RP0/CPU0:OLT-C-SITE-8(config-Ots)#add-drop-channel ots-Och 0/0/0/3/63
RP/0/RP0/CPU0:OLT-C-SITE-8(config-Ots)#commit
Tue Jul 26 06:56:46.290 UTC
RP/0/RP0/CPU0:OLT-C-SITE-8(config-Ots)#end
RP/0/RP0/CPU0:OLT-C-SITE-8#sh hw-module location 0/0/NXR0 terminal-ampli
Tue Jul 26 06:57:06.011 UTC
```

Legend:

NXC - Channel not cross-connected
ACTIVE - Channel cross-connected to data port
ASE - Channel filled with ASE
FAILED - Data channel failed, pending transition to ASE

Location: 0/0/NXR0

Status: Provisioned

Flex Grid Info

Channel Number	Centre Frequency (THz)	Channel Width (GHz)	Channel Status
1	196.100000	75.000	ACTIVE
3	195.950000	75.000	NXC
5	195.800000	75.000	ACTIVE

17	194.900000	75.000	ACTIVE
59	191.750000	75.000	ACTIVE
63	191.450000	75.000	ACTIVE
64	191.375000	75.000	ACTIVE

```
RP/0/RP0/CPU0:OLT-C-SITE-8#sh controllers ots-Och 0/0/0/0/63
Tue Jul 26 06:57:28.630 UTC
```

Controller State: Up

Transport Admin State: In Service

Alarm Status:

Detected Alarms: None

Parameter Statistics:

Total RX Power = -13.20 dBm
Total TX Power = -1.50 dBm

Cross Connect Info:

Add-Drop Channel = Ots-Och0/0/0/3/63

Configured Parameters:

```
RP/0/RP0/CPU0:OLT-C-SITE-8#sh controllers ots-Och 0/0/0/3/63
Tue Jul 26 06:57:35.129 UTC
```

Controller State: Up

Transport Admin State: Automatic In Service

Alarm Status:

Detected Alarms: None

Parameter Statistics:

Total RX Power = -7.50 dBm
Total TX Power = -21.80 dBm

Cross Connect Info:

line Channel = Ots-Och0/0/0/0/63

Configured Parameters:

After the cross-connects are created on the OLT nodes, APC regulates the power on each node. The APC status moves from WORKING to IDLE when the process completes. Use the **show olc apc** command to view the status of the operation. The following samples are for OLT-C-SITE-8.

RP/0/RP0/CPU0:OLT-C-SITE-8#sh olc apc
Tue Jul 26 06:57:16.020 UTC

Controller : Ots0/0/0/0
APC Status : WORKING
Correcting Node : 10.123.1.1

Node RID : 10.125.1.1
Internal State : IDLE

Node RID : 10.123.1.1
Internal State : CORRECTING

RP/0/RP0/CPU0:OLT-C-SITE-8#sh olc apc
Tue Jul 26 06:59:11.985 UTC

Controller : Ots0/0/0/0
APC Status : IDLE

Node RID : 10.125.1.1
Internal State : IDLE

Node RID : 10.123.1.1
Internal State : IDLE

After the APC process is complete, the link comes up. You can view the details using the **sh olc apc-local regulation-info controller ots** command on the near-end and far-end nodes.

OLT-R-C-SITE-1:

RP/0/RP0/CPU0:OLT-R-C-SITE-1#sh olc apc-local regulation-info controller ots 0/0/0/0
Tue Jul 26 07:02:57.244 UTC
Controller : Ots0/0/0/0
Domain Manager : 10.131.1.1
Internal Status : IDLE
Direction : TX
PSD Minimum : -22.0 (dBm/12.5 GHz)
Gain Range : Normal
Last Correction : 2022-07-26 06:34:43

Device Parameters	Min	Max	Configuration	Operational
Egress Ampli Gain (dB)	15.3	29.3	17.9	17.9
Egress Ampli Tilt (dB)	-5.0	4.3	-1.6	-1.6
TX Ampli Power (dBm)	-	22.3	-	21.6
TX VOA Attenuation (dB)	0.0	20.0	1.3	1.3
Egress WSS/DGE Attenuation (dB)	0.0	25.0	-	-

Channel Center Frequency (THz)	Channel Width (GHz)	Channel ID	Channel Source	Spectrum Slice Num	Ampli-Input PSD (dBm/12.5 GHz)	Target PSD (dBm/12.5 GHz)	Current PSD (dBm/12.5 GHz)	Discrepancy (dB)	Channel Slice Attn Config (dB)
191.375000	75.00	-	ASE	13	-21.2	-5.7	-5.7	0.0	7.3
191.449997	75.00	63	OCh	37	-21.5	-5.7	-5.9	0.2	19.0
191.524994	75.00	-	ASE	61	-21.3	-5.7	-5.7	0.0	7.3
191.600006	75.00	-	ASE	85	-21.2	-5.6	-5.6	0.0	7.3
191.675003	75.00	-	ASE	109	-21.2	-5.6	-5.6	0.0	7.4
191.750000	75.00	-	ASE	133	-21.1	-5.5	-5.5	0.0	7.3
191.824997	75.00	-	ASE	157	-21.1	-5.5	-5.5	0.0	7.3
191.899994	75.00	-	ASE	181	-21.1	-5.5	-5.5	0.0	7.3
191.975006	75.00	-	ASE	205	-21.2	-5.5	-5.5	0.0	7.4
192.050003	75.00	-	ASE	229	-21.1	-5.4	-5.4	0.0	7.2
192.125000	75.00	-	ASE	253	-21.1	-5.4	-5.4	0.0	7.2
192.199997	75.00	-	ASE	277	-21.0	-5.4	-5.4	0.0	7.2
192.274994	75.00	-	ASE	301	-21.1	-5.4	-5.4	0.0	7.2
192.350006	75.00	-	ASE	325	-21.0	-5.3	-5.3	0.0	7.0
192.425003	75.00	-	ASE	349	-21.0	-5.3	-5.3	0.0	6.9
192.500000	75.00	-	ASE	373	-21.0	-5.3	-5.4	0.1	7.0
192.574997	75.00	-	ASE	397	-20.9	-5.3	-5.3	0.0	7.0
192.649994	75.00	-	ASE	421	-20.9	-5.2	-5.2	0.0	7.0
192.725006	75.00	-	ASE	445	-20.9	-5.2	-5.2	0.0	6.9
192.800003	75.00	-	ASE	469	-20.9	-5.2	-5.2	0.0	6.9

192.875000	75.00	-	ASE	493	-20.9	-5.2	-5.2	0.0	6.9
192.949997	75.00	-	ASE	517	-20.8	-5.1	-5.1	0.0	6.8
193.024994	75.00	-	ASE	541	-20.9	-5.1	-5.1	0.0	6.8
193.100006	75.00	-	ASE	565	-20.9	-5.1	-5.1	0.0	6.7
193.175003	75.00	-	ASE	589	-20.9	-5.1	-5.1	0.0	6.6
193.250000	75.00	-	ASE	613	-20.8	-5.0	-5.0	0.0	6.5
193.324997	75.00	-	ASE	637	-20.9	-5.0	-5.1	0.0	6.6
193.399994	75.00	-	ASE	661	-20.8	-5.0	-5.0	0.0	6.5
193.475006	75.00	-	ASE	685	-20.9	-5.0	-5.0	0.0	6.5
193.550003	75.00	-	ASE	709	-20.9	-4.9	-4.9	0.0	6.5
193.625000	75.00	-	ASE	733	-20.9	-4.9	-4.9	0.0	6.5
193.699997	75.00	-	ASE	757	-20.9	-4.9	-4.9	0.0	6.5
193.774994	75.00	-	ASE	781	-21.0	-4.9	-4.9	0.0	6.6
193.850006	75.00	-	ASE	805	-20.9	-4.8	-4.8	0.0	6.5
193.925003	75.00	-	ASE	829	-21.0	-4.8	-4.8	0.0	6.6
194.000000	75.00	-	ASE	853	-21.0	-4.8	-4.8	0.0	6.6
194.074997	75.00	-	ASE	877	-21.0	-4.8	-4.7	0.0	6.6
194.149994	75.00	-	ASE	901	-21.0	-4.7	-4.7	0.0	6.7
194.225006	75.00	-	ASE	925	-21.0	-4.7	-4.7	0.0	6.8
194.300003	75.00	-	ASE	949	-21.1	-4.7	-4.7	0.0	6.9
194.375000	75.00	-	ASE	973	-21.0	-4.7	-4.6	0.0	6.9
194.449997	75.00	-	ASE	997	-21.0	-4.6	-4.6	0.0	6.9
194.524994	75.00	-	ASE	1021	-21.1	-4.6	-4.7	0.0	7.0
194.600006	75.00	-	ASE	1045	-21.1	-4.6	-4.6	0.0	6.9
194.675003	75.00	-	ASE	1069	-21.1	-4.6	-4.6	0.0	6.9
194.750000	75.00	-	ASE	1093	-21.1	-4.5	-4.5	0.0	6.8
194.824997	75.00	-	ASE	1117	-21.0	-4.5	-4.5	0.0	6.7
194.899994	75.00	17	OCh	1141	-21.2	-4.5	-4.5	0.0	19.5
194.975006	75.00	-	ASE	1165	-21.1	-4.5	-4.5	0.0	6.6
195.050003	75.00	-	ASE	1189	-21.0	-4.4	-4.4	0.0	6.4
195.125000	75.00	-	ASE	1213	-21.1	-4.4	-4.4	0.0	6.4
195.199997	75.00	-	ASE	1237	-21.1	-4.4	-4.4	0.0	6.3
195.274994	75.00	-	ASE	1261	-21.2	-4.4	-4.5	0.1	6.3
195.350006	75.00	-	ASE	1285	-21.2	-4.3	-4.3	0.0	6.2
195.425003	75.00	-	ASE	1309	-21.3	-4.3	-4.3	0.0	6.2
195.500000	75.00	-	ASE	1333	-21.3	-4.3	-4.3	0.0	6.2
195.574997	75.00	-	ASE	1357	-21.5	-4.3	-4.4	0.1	6.3
195.649994	75.00	-	ASE	1381	-21.5	-4.2	-4.3	0.0	6.4
195.725006	75.00	-	ASE	1405	-21.5	-4.2	-4.1	-0.1	6.5
195.800003	75.00	-	ASE	1429	-21.7	-4.2	-4.2	0.0	6.8
195.875000	75.00	-	ASE	1453	-21.9	-4.2	-4.3	0.1	7.1
195.949997	75.00	-	ASE	1477	-21.8	-4.2	-4.0	-0.1	7.1
196.024994	75.00	2	ASE	1501	-21.9	-4.1	-4.1	0.0	7.3
196.100006	75.00	-	ASE	1525	-21.9	-4.1	-4.0	-0.1	7.4

Controller : Ots0/0/0/0
 Domain Manager : 10.126.1.1
 Internal Status : IDLE
 Direction : RX
 PSD Minimum : -22.0 (dBm/12.5 GHz)
 Gain Range : Normal
 Last Correction : 2022-07-26 06:57:17

Device Parameters	Min	Max	Configuration	Operational
Ingress Ampli Gain (dB)	10.9	23.9	10.9	10.9
Ingress Ampli Tilt (dB)	-5.0	5.0	-1.6	-1.6
RX Ampli Power (dBm)	-	25.0	-	24.2
RX VOA Attenuation (dB)	0.0	0.0	0.0	0.0
Ingress WSS/DGE Attenuation (dB)	0.0	25.0	-	-

Channel Center Frequency (THz)	Channel Width (GHz)	Channel ID	Channel Source	Spectrum Slice Num	Ampli-Input PSD (dBm/12.5 GHz)	Target PSD (dBm/12.5 GHz)	Current PSD (dBm/12.5 GHz)	Discrepancy (dB)	Channel Slice Attn Config (dB)
191.375000	75.00	-	ASE	13	-11.1	-	-25.5	0.0	25.0
191.449997	75.00	63	OCh	37	-11.1	-8.0	-8.1	0.0	2.9
191.524994	75.00	-	ASE	61	-11.0	-	-25.4	0.0	25.0
191.600006	75.00	-	ASE	85	-11.0	-	-25.2	0.0	25.0
191.675003	75.00	-	ASE	109	-11.0	-	-25.3	0.0	25.0
191.750000	75.00	-	ASE	133	-11.0	-	-25.4	0.0	25.0
191.824997	75.00	-	ASE	157	-11.4	-	-25.6	0.0	25.0
191.899994	75.00	-	ASE	181	-11.4	-	-25.6	0.0	25.0
191.975006	75.00	-	ASE	205	-11.1	-	-25.4	0.0	25.0
192.050003	75.00	-	ASE	229	-11.0	-	-25.3	0.0	25.0
192.125000	75.00	-	ASE	253	-11.1	-	-25.4	0.0	25.0
192.199997	75.00	-	ASE	277	-11.4	-	-25.6	0.0	25.0
192.274994	75.00	-	ASE	301	-11.5	-	-25.7	0.0	25.0
192.350006	75.00	-	ASE	325	-11.3	-	-25.7	0.0	25.0
192.425003	75.00	-	ASE	349	-11.5	-	-25.7	0.0	25.0
192.500000	75.00	-	ASE	373	-11.6	-	-25.8	0.0	25.0
192.574997	75.00	-	ASE	397	-11.6	-	-25.7	0.0	25.0

192.649994	75.00	-	ASE	421	-11.7	-	-25.9	0.0	25.0
192.725006	75.00	-	ASE	445	-11.8	-	-26.1	0.0	25.0
192.800003	75.00	-	ASE	469	-11.9	-	-26.1	0.0	25.0
192.875000	75.00	-	ASE	493	-11.8	-	-26.0	0.0	25.0
192.949997	75.00	-	ASE	517	-12.0	-	-26.2	0.0	25.0
193.024994	75.00	-	ASE	541	-12.0	-	-26.1	0.0	25.0
193.100006	75.00	-	ASE	565	-11.9	-	-26.1	0.0	25.0
193.175003	75.00	-	ASE	589	-12.0	-	-26.3	0.0	25.0
193.250000	75.00	-	ASE	613	-11.9	-	-26.1	0.0	25.0
193.324997	75.00	-	ASE	637	-11.9	-	-26.1	0.0	25.0
193.399994	75.00	-	ASE	661	-12.0	-	-26.2	0.0	25.0
193.475006	75.00	-	ASE	685	-12.0	-	-26.2	0.0	25.0
193.550003	75.00	-	ASE	709	-12.0	-	-26.1	0.0	25.0
193.625000	75.00	-	ASE	733	-11.9	-	-26.0	0.0	25.0
193.699997	75.00	-	ASE	757	-11.6	-	-25.8	0.0	25.0
193.774994	75.00	-	ASE	781	-11.6	-	-25.7	0.0	25.0
193.850006	75.00	-	ASE	805	-11.5	-	-25.6	0.0	25.0
193.925003	75.00	-	ASE	829	-11.4	-	-25.6	0.0	25.0
194.000000	75.00	-	ASE	853	-11.5	-	-25.6	0.0	25.0
194.074997	75.00	-	ASE	877	-11.6	-	-25.6	0.0	25.0
194.149994	75.00	-	ASE	901	-11.7	-	-25.6	0.0	25.0
194.225006	75.00	-	ASE	925	-11.8	-	-25.6	0.0	25.0
194.300003	75.00	-	ASE	949	-12.0	-	-25.8	0.0	25.0
194.375000	75.00	-	ASE	973	-12.0	-	-25.8	0.0	25.0
194.449997	75.00	-	ASE	997	-12.1	-	-25.9	0.0	25.0
194.524994	75.00	-	ASE	1021	-12.2	-	-25.9	0.0	25.0
194.600006	75.00	-	ASE	1045	-12.2	-	-26.0	0.0	25.0
194.675003	75.00	-	ASE	1069	-12.2	-	-26.0	0.0	25.0
194.750000	75.00	-	ASE	1093	-12.3	-	-26.0	0.0	25.0
194.824997	75.00	-	ASE	1117	-12.4	-	-26.1	0.0	25.0
194.899994	75.00	17	OCh	1141	-12.3	-8.0	-8.1	-0.1	2.0
194.975006	75.00	-	ASE	1165	-12.1	-	-26.0	0.0	25.0
195.050003	75.00	-	ASE	1189	-12.0	-	-25.9	0.0	25.0
195.125000	75.00	-	ASE	1213	-12.0	-	-25.9	0.0	25.0
195.199997	75.00	-	ASE	1237	-12.0	-	-26.0	0.0	25.0
195.274994	75.00	-	ASE	1261	-11.8	-	-25.7	0.0	25.0
195.350006	75.00	-	ASE	1285	-11.7	-	-25.6	0.0	25.0
195.425003	75.00	-	ASE	1309	-11.6	-	-25.5	0.0	25.0
195.500000	75.00	-	ASE	1333	-11.7	-	-25.6	0.0	25.0
195.574997	75.00	-	ASE	1357	-11.8	-	-25.4	0.0	25.0
195.649994	75.00	-	ASE	1381	-11.4	-	-25.1	0.0	25.0
195.725006	75.00	-	ASE	1405	-11.5	-	-25.1	0.0	25.0
195.800003	75.00	-	ASE	1429	-11.7	-	-25.1	0.0	25.0
195.875000	75.00	-	ASE	1453	-11.8	-	-25.0	0.0	25.0
195.949997	75.00	-	ASE	1477	-11.6	-	-24.7	0.0	25.0
196.024994	75.00	2	ASE	1501	-11.9	-9.0	-8.9	-0.1	4.5
196.100006	75.00	-	ASE	1525	-11.9	-	-24.8	0.0	25.0

OLT-C-SITE-8:

```

RF/0/RP0/CPU0:OLT-C-SITE-8#sh otc apc-local regulation-info controller ots 0/0/0 tX
Tue Jul 26 06:59:33.786 UTC
Controller       : Ots0/0/0/0
Domain Manager   : 10.125.1.1
Internal Status  : IDLE
Direction       : TX
PSD Minimumum   : -24.0 (dBm/12.5 GHz)
Gain Range       : Normal
Last Correction  : 2022-07-26 06:57:09

```

Device Parameters	Min	Max	Configuration	Operational
Egress Ampli Gain (dB)	16.0	30.0	20.3	20.3
Egress Ampli Tilt (dB)	-5.0	3.0	-1.5	-1.5
TX Ampli Power (dBm)	-	23.0	-	22.1
TX VOA Attenuation (dB)	0.0	20.0	5.5	5.5
Egress WSS/DGE Attenuation (dB)	0.0	25.0	-	-

Channel Center Frequency (THz)	Channel Width (GHz)	Channel ID	Channel Source	Spectrum Slice Num	Ampli-Input PSD (dBm/12.5 GHz)	Target PSD (dBm/12.5 GHz)	Current PSD (dBm/12.5 GHz)	Discrepancy (dB)	Channel Slice Attn Config (dB)
191.375000	75.00	64	OCh	13	-23.0	-8.6	-8.6	0.0	20.2
191.449997	75.00	63	OCh	37	-23.0	-8.6	-8.6	0.0	18.3
191.524994	75.00	-	ASE	61	-23.0	-8.6	-8.6	0.0	7.7
191.600006	75.00	-	ASE	85	-23.1	-8.6	-8.7	0.1	7.8
191.675003	75.00	-	ASE	109	-23.0	-8.6	-8.6	0.0	7.6
191.750000	75.00	59	OCh	133	-23.0	-8.5	-8.6	0.0	20.0
191.824997	75.00	-	ASE	157	-23.1	-8.5	-8.5	0.0	7.8
191.899994	75.00	-	ASE	181	-23.0	-8.5	-8.5	0.0	7.7
191.975006	75.00	-	ASE	205	-23.0	-8.5	-8.5	0.0	7.7
192.050003	75.00	-	ASE	229	-23.0	-8.4	-8.4	0.0	7.6

192.125000	75.00	-	ASE	253	-23.0	-8.4	-8.5	0.0	7.7
192.199997	75.00	-	ASE	277	-23.1	-8.4	-8.5	0.1	7.8
192.274994	75.00	-	ASE	301	-22.9	-8.4	-8.3	0.0	7.6
192.350006	75.00	-	ASE	325	-22.9	-8.3	-8.4	0.0	7.5
192.425003	75.00	-	ASE	349	-22.9	-8.3	-8.3	0.0	7.5
192.500000	75.00	-	ASE	373	-22.8	-8.3	-8.3	0.0	7.5
192.574997	75.00	-	ASE	397	-23.0	-8.3	-8.4	0.1	7.6
192.649994	75.00	-	ASE	421	-22.8	-8.2	-8.2	0.0	7.4
192.725006	75.00	-	ASE	445	-22.8	-8.2	-8.3	0.0	7.4
192.800003	75.00	-	ASE	469	-22.9	-8.2	-8.3	0.1	7.5
192.875000	75.00	-	ASE	493	-22.8	-8.2	-8.3	0.1	7.5
192.949997	75.00	-	ASE	517	-22.7	-8.1	-8.0	-0.1	7.3
193.024994	75.00	-	ASE	541	-22.7	-8.1	-8.2	0.0	7.3
193.100006	75.00	-	ASE	565	-22.7	-8.1	-8.1	0.0	7.2
193.175003	75.00	-	ASE	589	-22.7	-8.1	-8.2	0.1	7.2
193.250000	75.00	-	ASE	613	-22.7	-8.1	-8.1	0.0	7.2
193.324997	75.00	-	ASE	637	-22.6	-8.0	-8.0	0.0	7.0
193.399994	75.00	-	ASE	661	-22.7	-8.0	-8.1	0.0	7.1
193.475006	75.00	-	ASE	685	-22.7	-8.0	-8.0	0.0	7.1
193.550003	75.00	-	ASE	709	-22.6	-8.0	-7.9	0.0	7.1
193.625000	75.00	-	ASE	733	-22.6	-7.9	-7.9	0.0	7.1
193.699997	75.00	-	ASE	757	-22.7	-7.9	-7.9	0.0	7.1
193.774994	75.00	-	ASE	781	-22.6	-7.9	-7.9	0.0	7.0
193.850006	75.00	-	ASE	805	-22.8	-7.9	-8.0	0.1	7.2
193.925003	75.00	-	ASE	829	-22.6	-7.8	-7.8	0.0	7.0
194.000000	75.00	-	ASE	853	-22.8	-7.8	-8.0	0.1	7.1
194.074997	75.00	-	ASE	877	-22.7	-7.8	-7.8	0.0	7.1
194.149994	75.00	-	ASE	901	-22.8	-7.8	-7.8	0.0	7.2
194.225006	75.00	-	ASE	925	-22.8	-7.8	-7.8	0.0	7.2
194.300003	75.00	-	ASE	949	-22.9	-7.7	-7.8	0.0	7.3
194.375000	75.00	-	ASE	973	-22.8	-7.7	-7.7	0.0	7.3
194.449997	75.00	-	ASE	997	-22.9	-7.7	-7.8	0.1	7.4
194.524994	75.00	-	ASE	1021	-22.7	-7.7	-7.5	-0.1	7.2
194.600006	75.00	-	ASE	1045	-22.8	-7.6	-7.6	0.0	7.3
194.675003	75.00	-	ASE	1069	-22.8	-7.6	-7.6	0.0	7.3
194.750000	75.00	-	ASE	1093	-22.8	-7.6	-7.6	0.0	7.2
194.824997	75.00	-	ASE	1117	-22.8	-7.6	-7.5	0.0	7.1
194.899994	75.00	17	OCh	1141	-22.9	-7.5	-7.5	0.0	18.8
194.975006	75.00	-	ASE	1165	-22.8	-7.5	-7.5	0.0	7.0
195.050003	75.00	-	ASE	1189	-22.9	-7.5	-7.5	0.0	7.1
195.125000	75.00	-	ASE	1213	-22.8	-7.5	-7.4	0.0	6.9
195.199997	75.00	-	ASE	1237	-22.9	-7.4	-7.4	0.0	6.8
195.274994	75.00	-	ASE	1261	-22.9	-7.4	-7.4	0.0	6.8
195.350006	75.00	-	ASE	1285	-23.0	-7.4	-7.4	0.0	6.9
195.425003	75.00	-	ASE	1309	-23.1	-7.4	-7.4	0.0	7.0
195.500000	75.00	-	ASE	1333	-23.1	-7.3	-7.4	0.0	6.8
195.574997	75.00	-	ASE	1357	-23.1	-7.3	-7.3	0.0	6.8
195.649994	75.00	-	ASE	1381	-23.3	-7.3	-7.4	0.1	7.0
195.725006	75.00	-	ASE	1405	-23.3	-7.3	-7.4	0.1	7.1
195.800003	75.00	5	OCh	1429	-23.3	-7.2	-7.2	0.0	19.1
195.875000	75.00	-	ASE	1453	-23.5	-7.2	-7.2	0.0	7.3
195.949997	75.00	-	ASE	1477	-23.6	-7.2	-7.2	0.0	7.4
196.024994	75.00	-	ASE	1501	-23.8	-7.2	-7.3	0.1	7.6
196.100006	75.00	1	OCh	1525	-23.7	-7.2	-7.1	0.0	19.4

ASE - Noise Loaded Channel
OCh - Optical Channel

RP/0/RP0/CPU0:OLT-C-SITE-8#sh olc apc-local regulation-info controller ots 0/0/0/0 rx
Tue Jul 26 06:59:42.151 UTC
Controller : Ots0/0/0/0
Domain Manager : 10.123.1.1
Internal Status : DISCREPANCY
Direction : RX
PSD Minimum : -24.0 (dBm/12.5 GHz)
Gain Range : Normal
Last Correction : 2022-07-26 06:59:39

Device Parameters	Min	Max	Configuration	Operational
Ingress Ampli Gain (dB)	12.0	25.0	19.7	19.7
Ingress Ampli Tilt (dB)	-5.0	1.8	0.4	0.4
RX Ampli Power (dBm)	-	25.0	-	24.2
RX VOA Attenuation (dB)	0.0	0.0	0.0	0.0
Ingress WSS/DGE Attenuation (dB)	0.0	25.0	-	-

Channel Center Frequency (THz)	Channel Width (GHz)	Channel ID	Channel Source	Spectrum Slice Num	Ampli-Input PSD (dBm/12.5 GHz)	Target PSD (dBm/12.5 GHz)	Current PSD (dBm/12.5 GHz)	Discrepancy (dB)	Channel Slice Attn Config (dB)
191.375000	75.00	64	OCh	13	-20.7	-8.0	-8.1	0.1	5.1
191.449997	75.00	63	OCh	37	-20.6	-8.0	-22.4	14.4	15.3

191.524994	75.00	62	ASE	61	-20.6	-	-25.6	0.0	25.0
191.600006	75.00	61	OCh	85	-20.6	-	-25.6	0.0	25.0
191.675003	75.00	-	ASE	109	-20.4	-	-25.4	0.0	25.0
191.750000	75.00	59	OCh	133	-20.4	-8.0	-8.1	0.0	5.4
191.824997	75.00	-	ASE	157	-20.4	-	-25.4	0.0	25.0
191.899994	75.00	-	ASE	181	-20.5	-	-25.5	0.0	25.0
191.975006	75.00	-	ASE	205	-20.4	-	-25.4	0.0	25.0
192.050003	75.00	-	ASE	229	-20.4	-	-25.4	0.0	25.0
192.125000	75.00	-	ASE	253	-20.3	-	-25.3	0.0	25.0
192.199997	75.00	-	ASE	277	-20.4	-	-25.4	0.0	25.0
192.274994	75.00	-	ASE	301	-20.5	-	-25.4	0.0	25.0
192.350006	75.00	-	ASE	325	-20.1	-	-25.2	0.0	25.0
192.425003	75.00	-	ASE	349	-20.2	-	-25.3	0.0	25.0
192.500000	75.00	-	ASE	373	-20.3	-	-25.3	0.0	25.0
192.574997	75.00	-	ASE	397	-20.4	-	-25.4	0.0	25.0
192.649994	75.00	-	ASE	421	-20.4	-	-25.3	0.0	25.0
192.725006	75.00	-	ASE	445	-20.3	-	-25.3	0.0	25.0
192.800003	75.00	-	ASE	469	-20.3	-	-25.3	0.0	25.0
192.875000	75.00	-	ASE	493	-20.3	-	-25.4	0.0	25.0
192.949997	75.00	-	ASE	517	-20.3	-	-25.3	0.0	25.0
193.024994	75.00	-	ASE	541	-20.2	-	-25.3	0.0	25.0
193.100006	75.00	-	ASE	565	-20.3	-	-25.4	0.0	25.0
193.175003	75.00	-	ASE	589	-20.3	-	-25.3	0.0	25.0
193.250000	75.00	-	ASE	613	-20.3	-	-25.5	0.0	25.0
193.324997	75.00	-	ASE	637	-20.2	-	-25.3	0.0	25.0
193.399994	75.00	-	ASE	661	-20.4	-	-25.5	0.0	25.0
193.475006	75.00	-	ASE	685	-20.4	-	-25.5	0.0	25.0
193.550003	75.00	-	ASE	709	-20.5	-	-25.6	0.0	25.0
193.625000	75.00	-	ASE	733	-20.4	-	-25.5	0.0	25.0
193.699997	75.00	-	ASE	757	-20.3	-	-25.4	0.0	25.0
193.774994	75.00	-	ASE	781	-20.4	-	-25.5	0.0	25.0
193.850006	75.00	-	ASE	805	-20.4	-	-25.5	0.0	25.0
193.925003	75.00	-	ASE	829	-20.3	-	-25.4	0.0	25.0
194.000000	75.00	-	ASE	853	-20.3	-	-25.4	0.0	25.0
194.074997	75.00	-	ASE	877	-20.4	-	-25.5	0.0	25.0
194.149994	75.00	-	ASE	901	-20.5	-	-25.5	0.0	25.0
194.225006	75.00	-	ASE	925	-20.4	-	-25.4	0.0	25.0
194.300003	75.00	-	ASE	949	-20.4	-	-25.5	0.0	25.0
194.375000	75.00	-	ASE	973	-20.4	-	-25.4	0.0	25.0
194.449997	75.00	-	ASE	997	-20.4	-	-25.5	0.0	25.0
194.524994	75.00	-	ASE	1021	-20.4	-	-25.4	0.0	25.0
194.600006	75.00	-	ASE	1045	-20.4	-	-25.4	0.0	25.0
194.675003	75.00	-	ASE	1069	-20.4	-	-25.5	0.0	25.0
194.750000	75.00	-	ASE	1093	-20.4	-	-25.4	0.0	25.0
194.824997	75.00	-	ASE	1117	-20.4	-	-25.4	0.0	25.0
194.899994	75.00	17	OCh	1141	-20.2	-8.0	-8.0	0.0	2.1
194.975006	75.00	-	ASE	1165	-20.3	-	-25.5	0.0	25.0
195.050003	75.00	-	ASE	1189	-20.2	-	-25.5	0.0	25.0
195.125000	75.00	-	ASE	1213	-20.3	-	-25.6	0.0	25.0
195.199997	75.00	-	ASE	1237	-20.3	-	-25.6	0.0	25.0
195.274994	75.00	-	ASE	1261	-20.2	-	-25.6	0.0	25.0
195.350006	75.00	-	ASE	1285	-20.2	-	-25.6	0.0	25.0
195.425003	75.00	-	ASE	1309	-20.0	-	-25.5	0.0	25.0
195.500000	75.00	-	ASE	1333	-20.1	-	-25.6	0.0	25.0
195.574997	75.00	-	ASE	1357	-20.1	-	-25.6	0.0	25.0
195.649994	75.00	-	ASE	1381	-19.9	-	-25.5	0.0	25.0
195.725006	75.00	-	ASE	1405	-19.8	-	-25.4	0.0	25.0
195.800003	75.00	5	ASE	1429	-19.9	-8.0	-7.9	0.0	1.8
195.875000	75.00	-	ASE	1453	-19.8	-	-25.3	0.0	25.0
195.949997	75.00	3	ASE	1477	-19.7	-	-25.2	0.0	25.0
196.024994	75.00	-	ASE	1501	-19.7	-	-25.0	0.0	25.0
196.100006	75.00	1	OCh	1525	-19.5	-8.0	-8.1	0.0	6.0

ASE - Noise Loaded Channel
OCh - Optical Channel

Bringup NCS 1010 Using ZTP

Perform the configurations in the following sequence to bring up NCS 1010 using ZTP.

- [DHCP Configuration, on page 16](#)
- [ZTP Configuration Files Creation, on page 52](#)
- [ZTP Configuration Workflow, on page 59](#)
- [Cross-connect Configuration, on page 35](#)

DHCP Configuration

DHCP configuration is required for both manual configuration and ZTP configuration.

To run iPXE and ZTP, you need a DHCP server. To configure a DHCP server, you must edit the `dhcpd.conf` file available at `/etc/dhcp/`. This configuration file stores the network information such as the path to the script, location of the ISO install file, location of the provisioning configuration (`.cfg`) file, and serial number or the MAC address of the chassis.

In the following example, the settings in the `dhcpd.conf` refers to the span connecting OLT-R-C-SITE-1 to OLT-C-SITE-2.

Figure 4: NetworkTopology Diagram

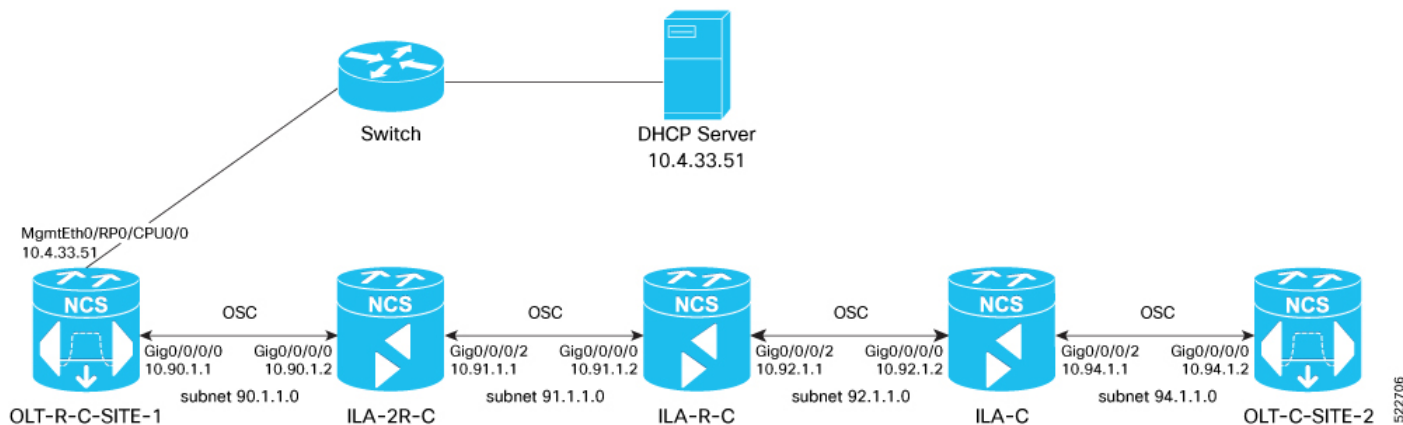

Note Restart the `dhcpd` service using the `service dhcpd restart` command every time you edit the `dhcpd.conf` file.

Add the following settings to the `dhcpd.conf` file :



Note The ZTP configuration files (`*.cfg`) that are referenced in the `dhcpd.conf` file are detailed in [ZTP Configuration Files Creation](#), on page 52.

```
# DHCP Server Configuration file
ddns-update-style none;
option domain-name "cisco.com";
option domain-name-servers dns-blr1.cisco.com;

default-lease-time 6000;
max-lease-time 72000;

log-facility local7;

option space VendorInfo;

option VendorInfo.clientId code 1 = string;

option VendorInfo.authCode code 2 = unsigned integer 8;

option VendorInfo.md5sum code 3 = string;

option vendor-specific code 43 = encapsulate VendorInfo;
```

```

option space cisco-vendor-id-vendor-class code width 1 length width 1;
option vendor-class.cisco-vendor-id-vendor-class code 9 = {string};
option bootstrap_servers code 143 = text;

ddns-update-style none;

#iPXE https specific configs
option space ipxe;
option ipxe-encap-opts code 175 = encapsulate ipxe;
option ipxe.crosscert code 93 = string;
option ipxe.crosscert "http://10.127.60.159/pub/mirror/ca.ipxe.org/auto";

#ZTP over OSC Configuration

subnet 10.90.1.0 netmask 255.255.255.0 {
  option domain-name-servers dns-blr1.cisco.com;
  option domain-name "cisco.com";
  option routers 10.90.1.1;
  #option netbios-name-serv;
}

subnet 10.91.1.0 netmask 255.255.255.0 {
  option domain-name-servers dns-blr1.cisco.com;
  option domain-name "cisco.com";
  option routers 10.91.1.1;
  #option netbios-name-serv;
}

subnet 10.92.1.0 netmask 255.255.255.0 {
  option domain-name-servers dns-blr1.cisco.com;
  option domain-name "cisco.com";
  option routers 10.92.1.1;
  #option netbios-name-serv;
}

subnet 10.94.1.0 netmask 255.255.255.0 {
  option domain-name-servers dns-blr1.cisco.com;
  option domain-name "cisco.com";
  option routers 10.94.1.1;
  #option netbios-name-serv;
}

#DHCP Relay Configuration

host OLT-R-C-SITE-1 {
  hardware ethernet 38:fd:f8:66:09:52;
  if exists user-class and option user-class = "iPXE" {
    filename "http://10.4.33.51/NCS1010/ncs1010-x64.iso";
  } else {
    filename "http://10.4.33.51/NCS1010_CFG/OLT-R-C-SITE-1.cfg";
  }
  fixed-address 10.4.33.131;
}

host ILA-2R-C {
  hardware ethernet 38:fd:f8:66:08:f6;
  fixed-address 10.90.1.2;
  if exists user-class and option user-class = "iPXE" {
    filename "http://10.4.33.51/NCS1010/ncs1010-x64.iso";
  }
}

```

```

vendor-option-space VendorInfo;
option VendorInfo.clientId "xr-config";
option VendorInfo.authCode 0;
option bootfile-name "http://10.4.33.51/NCS1010_CFG/ILA-2R-C.cfg";
}

host ILA-R-C {
hardware ethernet 38:fd:f8:66:09:f2;
fixed-address 10.91.1.2;
if exists user-class and option user-class = "iPXE" {
filename "http://10.4.33.51/NCS1010/ncs1010-x64.iso";
}
vendor-option-space VendorInfo;
option VendorInfo.clientId "xr-config";
option VendorInfo.authCode 0;
option bootfile-name "http://10.4.33.51/NCS1010_CFG/ILA-R-C.cfg";
}

host ILA-C {
hardware ethernet 38:fd:f8:66:09:7d;
fixed-address 10.92.1.2;
if exists user-class and option user-class = "iPXE" {
filename "http://10.4.33.51/NCS1010/ncs1010-x64.iso";
}
vendor-option-space VendorInfo;
option VendorInfo.clientId "xr-config";
option VendorInfo.authCode 0;
option bootfile-name "http://10.4.33.51/NCS1010_CFG/ILA-C.cfg";
}

host OLT-C-SITE-2 {
hardware ethernet 38:fd:f8:66:06:79;
if exists user-class and option user-class = "iPXE" {
filename "http://10.4.33.51/NCS010/ncs1010-x64.iso";
} else {
filename "http://10.4.33.51/NCS1010_CFG/OLT-C-SITE-2.cfg";
}
fixed-address 192.0.2.121;
}

```

To create the static routes in the DHCP server, use the following commands:

route add -net *OLT-OSC-ip* gw *OLT-MGMT-ip* netmask 255.255.255.255 dev eth3

route add -net *ILA-OSC-ip* gw *OLT-MGMT-ip* netmask 255.255.255.255 dev eth3

```

[root@vxr-ncs1010-02 ~]# route add -net 10.90.1.1 gw 10.4.33.131 netmask 255.255.255.255 dev eth3
[root@vxr-ncs1010-02 ~]# route add -net 10.90.1.2 gw 10.4.33.131 netmask 255.255.255.255 dev eth3
[root@vxr-ncs1010-02 ~]# route add -net 10.91.1.1 gw 10.4.33.131 netmask 255.255.255.255 dev eth3
[root@vxr-ncs1010-02 ~]# route add -net 10.91.1.2 gw 10.4.33.131 netmask 255.255.255.255 dev eth3
[root@vxr-ncs1010-02 ~]# route add -net 10.92.1.1 gw 10.4.33.131 netmask 255.255.255.255 dev eth3
[root@vxr-ncs1010-02 ~]# route add -net 10.92.1.2 gw 10.4.33.131 netmask 255.255.255.255 dev eth3
[root@vxr-ncs1010-02 ~]# route add -net 10.94.1.1 gw 10.4.33.131 netmask 255.255.255.255 dev eth3
[root@vxr-ncs1010-02 ~]# route add -net 10.94.1.2 gw 10.4.33.131 netmask 255.255.255.255 dev eth3

```

10.4.33.131 is the management IP address for the gateway node.

ZTP Configuration Files Creation

You can build the ZTP configuration files based on your network requirements. The sample ZTP files created below are used to configure the nodes from OLT-R-C-SITE-1 to OLT-C-SITE-2 as shown in the figure below. You can create similar ZTP configuration files for the rest of the NCS 1010 nodes.

Figure 5: Network Topology Diagram

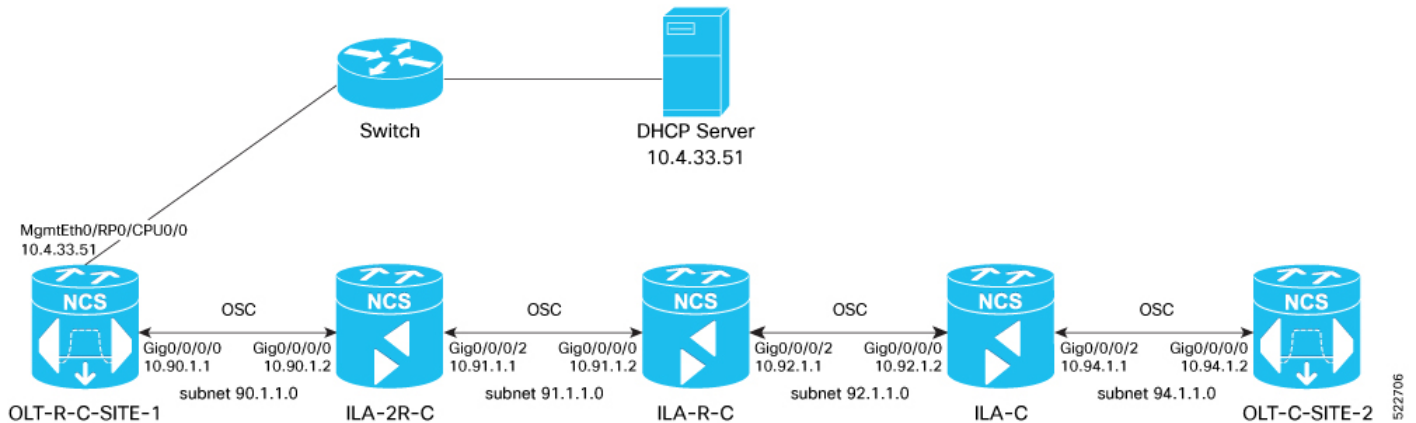

Note You can remotely manage an ILA node that is not connected to a management network through an OLT gateway node via an OSC interface. ZTP can be initiated from a remote node through DHCP relay. For more information see, [Remote Node Management in NCS 1010](#).

Build the ZTP configuration files by typing the following in Notepad and save them as .cfg files in the DHCP server.

OLT-R-C-SITE-1 node:

```
!! IOS XR Configuration 7.7.1.31I
!! Last configuration change at Mon Jul  4 11:10:16 2022 by cisco
!
hostname OLT-R-C-SITE-1
logging console informational
username cisco
group root-lr
group cisco-support
password 7 01100F17585B575D72
!
grpc
port 57400
!

dhcp ipv4
profile r1 relay
  helper-address vrf default 10.4.33.51 giaddr 10.90.1.1
!
interface GigabitEthernet0/0/0/0 relay profile r1

interface Loopback0
ipv4 address 10.131.1.1 255.255.255.255
!
interface MgmtEth0/RP0/CPU0/0
ipv4 address 10.4.33.131 255.255.255.0
```

```

!
interface MgmtEth0/RP0/CPU0/1
shutdown
!
interface MgmtEth0/RP0/CPU0/2
ipv4 address 10.127.59.22 255.255.255.0
!
interface GigabitEthernet0/0/0/0
ipv4 address 10.90.1.1 255.255.255.0
!

router static
address-family ipv4 unicast
 0.0.0.0/0 10.4.33.1
 0.0.0.0/0 10.127.59.1
!
!
router ospf 1
distribute link-state
network point-to-point
redistribute connected
area 0
 interface Loopback0
  !
 interface GigabitEthernet0/0/0/0
  !
ssh server rate-limit 600
ssh server session-limit 110
ssh server v2
ssh server netconf vrf default

optical-line-control
automatic-link-bringup
!

```

Save this file as **OLT-R-C-SITE-1.cfg**.

ILA-2R-C node:

```

!! IOS XR Configuration 7.7.1.31I
!! Last configuration change at Fri Jul 1 05:44:39 2022 by cisco
!
hostname ILA-2R-C
logging console debugging
domain name cisco.com
domain name-server 198.51.100.123
username cisco
group root-lr
group cisco-support
password 7 070C285F4D59485744
!
grpc
!
line console
exec-timeout 0 0
absolute-timeout 0
session-timeout 0
!
line default
exec-timeout 0 0
absolute-timeout 0
session-timeout 0
!
dhcp ipv4

```

```

profile r1 relay
  helper-address vrf default 10.4.33.51 giaddr 10.91.1.1
!
interface GigabitEthernet0/0/0/2 relay profile r1
!
!
netconf-yang agent
ssh
!
interface Loopback0
ipv4 address 10.128.1.1 255.255.255.255
!
interface MgmtEth0/RP0/CPU0/0
ipv4 address 10.4.33.128 255.255.255.0
!
interface MgmtEth0/RP0/CPU0/1
ipv4 address dhcp
shutdown
!
interface MgmtEth0/RP0/CPU0/2
ipv4 address 10.127.59.24 255.255.255.0
!
interface GigabitEthernet0/0/0/0
ipv4 address 10.90.1.2 255.255.255.0
!
interface GigabitEthernet0/0/0/2
ipv4 address 10.91.1.1 255.255.255.0
!
interface PTP0/RP0/CPU0/0
shutdown
!
interface PTP0/RP0/CPU0/1
shutdown
!
router static
address-family ipv4 unicast
  0.0.0.0/0 10.4.33.1
  0.0.0.0/0 10.127.59.1
!
!
router ospf 1
distribute link-state instance-id 0 throttle 5
network point-to-point
redistribute connected
area 0
  interface Loopback0
  !
  interface GigabitEthernet0/0/0/0
  !
  interface GigabitEthernet0/0/0/2
  !
!
!
optical-line-control
automatic-link-bringup

ssh server rate-limit 600
ssh server session-limit 110
ssh server v2
ssh server netconf vrf default
end

!! Last configuration change at Mon Jul 4 08:22:51 2022 by cisco

```

Save this file as **ILA-2R-C.cfg**.

ILA-R-C node:

```
!! IOS XR Configuration 7.7.1.31I
!! Last configuration change at Fri Jun  3 06:26:03 2022 by cisco
!
hostname ILA-R-C
username test
password 7 094F471A1A55464058
!
username cisco
group root-lr
group cisco-support
password 7 110A101614425A5E57
!
grpc
!
line console
exec-timeout 0 0
absolute-timeout 0
session-timeout 0
!
line default
exec-timeout 0 0
absolute-timeout 0
session-timeout 0
!

dhcp ipv4
profile r1 relay
  helper-address vrf default 10.4.33.51 giaddr 10.92.1.1
!
interface GigabitEthernet0/0/0/2 relay profile r1
!
!

netconf-yang agent
ssh
!
interface Loopback0
ipv4 address 10.134.1.1 255.255.255.255
!
interface MgmtEth0/RP0/CPU0/0
ipv4 address 10.4.33.134 255.255.255.0
!
interface MgmtEth0/RP0/CPU0/1
shutdown
!
interface MgmtEth0/RP0/CPU0/2
ipv4 address 10.127.59.28 255.255.255.0
!
interface GigabitEthernet0/0/0/0
ipv4 address 10.91.1.2 255.255.255.0
!
interface GigabitEthernet0/0/0/2
ipv4 address 10.92.1.1 255.255.255.0
!
interface PTP0/RP0/CPU0/0
shutdown
!
interface PTP0/RP0/CPU0/1
shutdown
!
```

```

router static
address-family ipv4 unicast
 0.0.0.0/0 10.4.33.1
 0.0.0.0/0 10.127.59.1
!
!
router ospf 1
distribute link-state instance-id 0 throttle 5
network point-to-point
redistribute connected
area 0
 interface Loopback0
  !
 interface GigabitEthernet0/0/0/0
  !
 interface GigabitEthernet0/0/0/2
  !
!
!
optical-line-control
automatic-link-bringup
ssh server rate-limit 600
!
ssh server session-limit 110
ssh server v2
ssh server netconf vrf default
end

```

Save this file as **ILA-R-C.cfg**.

ILA-C node:

```

Building configuration...
!! IOS XR Configuration 7.7.1.31I
!! Last configuration change at Fri Jun  3 06:26:55 2022 by cisco
!
hostname ILA-C
logging console informational
username cisco
group root-lr
group cisco-support
password 7 01100F17585B575D72
!
grpc
!
line console
exec-timeout 0 0
absolute-timeout 0
session-timeout 0
!
line default
exec-timeout 0 0
absolute-timeout 0
session-timeout 0
!
dhcp ipv4
profile r1 relay
 helper-address vrf default 10.4.33.51 giaddr 10.94.1.1
!
interface GigabitEthernet0/0/0/2 relay profile r1
!

netconf-yang agent
ssh
!

```



```

interface Loopback0
ipv4 address 10.122.1.1 255.255.255.255
!
interface MgmtEth0/RP0/CPU0/0
ipv4 address 10.4.33.122 255.255.255.0
!
interface MgmtEth0/RP0/CPU0/1
shutdown
!
interface MgmtEth0/RP0/CPU0/2
ipv4 address 10.127.59.54 255.255.255.0
!
interface GigabitEthernet0/0/0/0
ipv4 address 10.92.1.2 255.255.255.0
!
interface GigabitEthernet0/0/0/2
ipv4 address 10.94.1.1 255.255.255.0
!
!
interface PTP0/RP0/CPU0/0
shutdown
!
interface PTP0/RP0/CPU0/1
shutdown
!
router static
address-family ipv4 unicast
 0.0.0.0/0 10.4.33.1
 0.0.0.0/0 10.127.59.1
!
!
router ospf 1
distribute link-state
segment-routing mpls
network point-to-point
redistribute connected
area 0
 interface Loopback0
 !
 interface GigabitEthernet0/0/0/0
 !
 interface GigabitEthernet0/0/0/2
 !

ssh server rate-limit 600
ssh server session-limit 110
ssh server v2
ssh server netconf vrf default
optical-line-control
automatic-link-bringup
end

```

Save this file as **ILA-C.cfg**.

OLT-C-SITE-2 node:

```

!! IOS XR Configuration 7.7.1.31I
!! Last configuration change at Mon Jul  4 08:22:51 2022 by cisco
!
hostname OLT-C-SITE-2
username cisco
group root-lr
group cisco-support
password 7 02050D4808565E731F
!

```

```

grpc
!
line console
exec-timeout 0 0
absolute-timeout 0
session-timeout 0
!
line default
exec-timeout 0 0
absolute-timeout 0
session-timeout 0
!
interface Loopback0
ipv4 address 10.126.1.1 255.255.255.255
!

interface MgmtEth0/RP0/CPU0/0
ipv4 address 10.4.33.126 255.255.255.0
!
interface MgmtEth0/RP0/CPU0/1
ipv4 address 10.127.59.98 255.255.255.0
!
interface MgmtEth0/RP0/CPU0/2
ipv4 address 10.127.59.98 255.255.255.0
!
interface GigabitEthernet0/0/0/0
ipv4 address 10.94.1.2 255.255.255.0
!
interface PTP0/RP0/CPU0/0
shutdown
!
interface PTP0/RP0/CPU0/1
shutdown
!
router static
address-family ipv4 unicast
 0.0.0.0/0 10.4.33.1
 0.0.0.0/0 10.127.59.1
!
!
router ospf 1
distribute link-state instance-id 0 throttle 5
network point-to-point
redistribute connected
area 0
 interface Loopback0
 !
 interface GigabitEthernet0/0/0/0
 !

optical-line-control
automatic-link-bringup

ssh server rate-limit 600
ssh server session-limit 110
ssh server v2
ssh server netconf vrf default
end

```

Save this file as **OLT-C-SITE-2.cfg**.

These configuration files are referenced in the `dhcpd.conf` file.

For more information on ZTP, see [Boot Using Zero Touch Provisioning](#).

ZTP Configuration Workflow

This section details how to bringup NCS 1010 nodes using ZTP. Verification outputs have been added at various steps. The iPXE CLI boot process has been used for this example.

The example used in this section is part of the overall network topology.

Figure 6: Network Topology Diagram

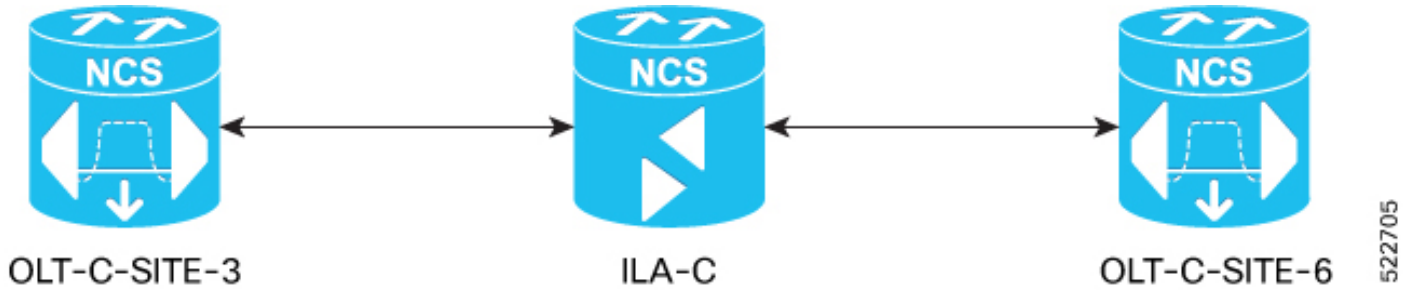

Note Before you use the iPXE boot, ensure that the DHCP server is set and is running. Create a `dhcpd.conf` file and the required ZTP configuration files specific to the nodes in the network topology diagram shown above. For samples of the `dhcpd.conf` file and the ZTP configuration files, see [DHCP Configuration, on page 16](#) and [ZTP Configuration Files Creation, on page 52](#).

1. Run the following CLI command to invoke the iPXE boot process to reimage the chassis:



Note This command deletes the existing configuration on the node.

```
RP/0/RP0/CPU0:ios#reload bootmedia network location 0/RP0/CPU0 noprompt
Mon Aug  1 11:49:27.269 UTC
```

```
Preparing system for backup. This may take a few minutes especially for large configurations.
Status report: node0_RP0_CPU0: START TO BACKUP
RP/0/RP0/CPU0:ios# Status report: node0_RP0_CPU0: BACKUP HAS COMPLETED SUCCESSFULLY
[Done]
[ OK ] Stopped Docker Application Container Engine.
[ OK ] Stopped target Network is Online.
[ OK ] Stopped target Network.
Stopping Network Service...
[ OK ] Stopped Network Service.
Stopping D-Bus System Message Bus...
.
.
snipped
.
.
[ OK ] Stopped Patch Sirius specific OS-SDK.
[ OK ] Reached target Shutdown.
[513293.089137] reboot: Restarting system

..
System Initializing..
..
```

ERROR: Class:0; Subclass:10000; Operation: 1004

CPU Rese

..
System Initializing..

NCS1010, Initializing Devices

Booting from Primary Flash
Aldrin: Skipping reprogram

Version 2.19.1266. Copyright (C) 2022 American Megatrends, Inc.
BIOS Date: 05/20/2022 10:47:39 Ver: 0ACHI0410
Press or <ESC> to enter setup.
TAM Chipguard Validate Observed DB Error: 0x48

WARNING!!! TAM: Empty Chip DB

Software Boot OK, Validated

iPXE initialising devices...ok

iPXE 1.0.0+ (c2215) -- Open Source Network Boot Firmware -- <http://ipxe.org>
Features: DNS HTTP TFTP VLAN EFI ISO9660 ISO9660_grub Menu
Trying net0-2051,net0-2052 and net0-2053...
net0-2051: 38:fd:f8:66:09:49 using NII on NII-PCI06:00.0 (open)
[Link:down, TX:0 TXE:0 RX:0 RXE:0]
[Link status: Unknown (<http://ipxe.org/1a086194>)]
Configuring (net0-2051 38:fd:f8:66:09:49)..... ok
net0: fe80::3afd:f8ff:fe66:949/64

.
.snipped

[OK] Started Cisco Directory Services.
[OK] Started Lightning Fast Webserver With Light System Requirements.
Starting NOS Bootup FPD Upgrade Service...
[OK] Started NOS Bootup FPD Upgrade Service.
Starting IOS-XR Reaperd and Process Manager...
[OK] Started IOS-XR Reaperd and Process Manager.
Starting Setting Cgroups...
[OK] Started Shutdown start service.
[OK] Started Setting Cgroups.
[OK] Started Kdump.
[OK] Reached target Multi-User System.
Starting Update UTMP about System Runlevel Changes...
[OK] Reached target XR installation and startup.
[OK] Started Update UTMP about System Runlevel Changes.

ios con0/RP0/CPU0 is now available

Press RETURN to get started.

This product contains cryptographic features and is subject to United States and local country laws governing import, export, transfer and

use. Delivery of Cisco cryptographic products does not imply third-party authority to import, export, distribute or use encryption. Importers, exporters, distributors and users are responsible for compliance with U.S. and local country laws. By using this product you agree to comply with applicable laws and regulations. If you are unable to comply with U.S. and local laws, return this product immediately.

A summary of U.S. laws governing Cisco cryptographic products may be found at:
<http://www.cisco.com/wwl/export/crypto/tool/stqrg.html>

If you require further assistance please contact us by sending email to export@cisco.com.

```
RP/0/RP0/CPU0:Aug 1 12:02:22.779 UTC: ifmgr[338]: %PKT_INFRA-LINK-3-UPDOWN : Interface GigabitEthernet0/0/0/0,
  changed state to Down
RP/0/RP0/CPU0:Aug 1 12:02:23.100 UTC: osa_driver[254]: %PKT_INFRA-FM-4-FAULT_MINOR : ALARM_MINOR
:PROV-INPROGRESS :DECLARE :Oms0/2/0/8:
RP/0/RP0/CPU0:Aug 1 12:02:23.101 UTC: osa_driver[254]: %PKT_INFRA-FM-4-FAULT_MINOR : ALARM_MINOR
:PROV-INPROGRESS :DECLARE :Oms0/2/0/9:
.
.
snipped
.
.
```

```
!!!!!!!!!!!!!!!!!!!!!! NO root-system username is configured. Need to configure root-system username.
!!!!!!!!!!!!!!!!!!!!!!
```

--- Administrative User Dialog ---

```
Enter root-system username: cisco
Enter secret:
Enter secret again:
Use the 'configure' command to modify this configuration.
User Access Verification
```

```
Username: cisco
Password:
```

```
RP/0/RP0/CPU0:ios#show running-config
Mon Aug 1 12:10:54.415 UTC
Building configuration...
!! IOS XR Configuration 7.7.1
!! Last configuration change at Mon Aug 1 12:10:44 2022 by SYSTEM
!
username cisco
  group root-lr
  group cisco-support
  secret 10
$6$lyk2E/DA/IH.3E/.$zxy.C0dqbPVwRQ.N5GKpnXFxlExAHYtnF45MvSBzhNVy15TyleFlx.Xbxlc8.JPMubwGlFkauRfeqAAjPrOTr1
!
call-home
  service active
  contact smart-licensing
  profile CiscoTAC-1
  active
  destination transport-method email disable
  destination transport-method http
```

```

!
!
interface MgmtEth0/RP0/CPU0/0
  ipv6 enable
!
interface MgmtEth0/RP0/CPU0/1
  ipv6 enable
!
interface MgmtEth0/RP0/CPU0/2
  ipv6 enable
!
interface GigabitEthernet0/0/0/0
  ipv6 enable
!
interface PTP0/RP0/CPU0/0
  shutdown
!
interface PTP0/RP0/CPU0/1
  shutdown
!
end

```

2. To remove all the ZTP logs and saved settings, use the following command:

```

RP/0/RP0/CPU0:ios#ztp clean
Mon Aug  1 12:11:07.816 UTC
This would remove all ZTP temporary files.
Would you like to proceed? [no]: yes
2022-08-01 12:11:10.674178:          ztp[ 1900, t 1900]: ERROR: ztp_proc_start
: 104: Failed to start process with error: 'processmgr' detected the 'warning' condition 'The target
process is already running.'
All ZTP operation files have been removed.
ZTP logs are present in /var/log/ztp*.log for logrotate.
Please remove manually if needed.
If you now wish ZTP to run again from boot, do 'conf t/commit replace' followed by reload.
RP/0/RP0/CPU0:ios#

```

3. To invoke ZTP manually, use the following command:

```

RP/0/RP0/CPU0:ios#ztp initiate
Mon Aug  1 12:11:24.572 UTC
Initiating ZTP may change your configuration.
Interfaces might be brought up if they are in shutdown state
Would you like to proceed? [no]: yes
ZTP will now run in the background.
RP/0/RP0/CPU0:ios#show logging | i ztp
Mon Aug  1 12:12:05.736 UTC
RP/0/RP0/CPU0:Aug  1 12:02:10.074 UTC: pyztp2[196]: %INFRA-ZTP-6-START : ZTP has started. Interfaces might
be brought up if they are shutdown
RP/0/RP0/CPU0:Aug  1 12:03:18.574 UTC: pyztp2[196]: %INFRA-ZTP-6-DISCOVERY_COMPLETED : Discovery successful
on MgmtDhcp4Fetcher. Will proceed with fetching.
.
.
snipped
.
.

RP/0/RP0/CPU0:Aug  1 12:12:40.784 UTC: osa_driver[254]: %PKT_INFRA-FM-4-FAULT_MINOR : ALARM_MINOR
:PROV-INPROGRESS :CLEAR :Oms0/2/0/13:
RP/0/RP0/CPU0:Aug  1 12:12:42.011 UTC: config[69106]: %MGBL-CONFIG-6-DB_COMMIT : Configuration committed by
user 'ZTP'. Use 'show configuration commit changes 1000000018' to view the changes.
RP/0/RP0/CPU0:Aug  1 12:12:50.103 UTC: pyztp2[196]: %INFRA-ZTP-6-PROVISIONING_COMPLETED : Provisioning
successful

```

```

RP/0/RP0/CPU0:Aug  1 12:12:52.464 UTC: ospf[1036]: %ROUTING-OSPF-5-ADJCHG : Process 1, Nbr 10.121.1.1 on
GigabitEthernet0/0/0/0 in area 0 from LOADING to FULL, Loading Done, vrf default vrfid 0x60000000
RP/0/RP0/CPU0:Aug  1 12:12:57.733 UTC: olc[159]: %PKT_INFRA-FM-4-FAULT_MINOR : ALARM_MINOR :APC-BLOCKED
:CLEAR :Ots0/0/0/0:
RP/0/RP0/CPU0:Aug  1 12:12:58.997 UTC: pyztp2[196]: %INFRA-ZTP-4-EXITED : ZTP exited

```

4. To view the running configuration on OLT-C-SITE-3:

```

RP/0/RP0/CPU0:OLT-C-SITE-3#show running-config
Mon Aug  1 12:13:07.535 UTC
Building configuration...
!! IOS XR Configuration 7.7.1
!! Last configuration change at Mon Aug  1 12:12:28 2022 by ZTP
!
hostname OLT-C-SITE-3
logging console informational
username cisco
  group root-lr
  group cisco-support
  password 7 1511021F077A7A767B67
!
grpc
  port 57400
  no-tls
!
address-family ipv4 unicast
!
line console
  exec-timeout 0 0
  absolute-timeout 0
  session-timeout 0
!
line default
  exec-timeout 0 0
  absolute-timeout 0
  session-timeout 0
!
.
.
snipped
.
.
!
!
ssh server rate-limit 600
ssh server session-limit 110
ssh server v2
ssh server vrf default
ssh server netconf vrf default
auto-ip-ring
end

```

5. Use the following show commands to view the status of the optical applications that are running on OLT-C-SITE-3:

```

RP/0/RP0/CPU0:OLT-C-SITE-3#show olc apc
Mon Aug  1 12:13:15.379 UTC

Controller      : Ots0/0/0/0
APC Status      : WORKING
Correcting Node : 10.120.1.1

Node RID        : 10.120.1.1
Internal State  : CORRECTING

Node RID        : 10.121.1.1

```

Internal State : DISCREPANCY

RP/0/RP0/CPU0:OLT-C-SITE-3#show olc apc
Mon Aug 1 12:20:48.513 UTC

Controller : Ots0/0/0/0
APC Status : IDLE

Node RID : 10.120.1.1
Internal State : IDLE

Node RID : 10.121.1.1
Internal State : IDLE

RP/0/RP0/CPU0:OLT-C-SITE-3#show olc span-loss
Mon Aug 1 12:23:19.827 UTC

Controller name : Ots0/0/0/0
Neighbour RID : 10.121.1.1
Rx Span Loss : 10.3 dB
Rx Span Loss (with pumps off) : NA
Rx Span Loss (with pumps off) measured at : NA
Estimated Rx Span Loss : NA
Tx Span Loss : 15.3 dB
Tx Span Loss (with pumps off) : NA
Tx Span Loss (with pumps off) measured at : NA
Estimated Tx Span Loss : NA

RP/0/RP0/CPU0:OLT-C-SITE-3#show olc gain-estimator
Mon Aug 1 12:23:27.016 UTC

Controller : Ots0/0/0/0
Ingress Gain Estimator Status : IDLE
Ingress Estimated Gain : 17.0 dB
Ingress Estimated Gain Mode : Normal
Ingress Gain Estimation Timestamp : 2022-08-01 12:14:05

RP/0/RP0/CPU0:OLT-C-SITE-3#show olc link-tuner
Mon Aug 1 12:23:32.651 UTC

Controller : Ots0/0/0/0
Link Tuner Status : OPERATIONAL
Last PSD computation: 2022-08-01 12:14:29

Setpoint : Computed PSD
(dBm/12.5 GHz)

01	-6.4
02	-6.4
03	-6.3
04	-6.3
05	-6.3
06	-6.2
07	-6.2
08	-6.2
09	-6.1
10	-6.1
11	-6.1
12	-6.0
13	-6.0
14	-6.0
15	-5.9
16	-5.9
17	-5.8
18	-5.8

19	-5.8
20	-5.7
21	-5.7
22	-5.7
23	-5.6
24	-5.6
25	-5.6
26	-5.5
27	-5.5
28	-5.4
29	-5.4
30	-5.4
31	-5.3
32	-5.3
33	-5.3

6. To view the running configuration on OLT-C-SITE6:

```
RP/0/RP0/CPU0:OLT-C-SITE6#show running-config
Tue Aug  2 05:07:27.989 UTC
Building configuration...
!! IOS XR Configuration 7.7.1.33I
!! Last configuration change at Mon Aug  1 12:29:44 2022 by cisco
!
hostname OLT-C-SITE6
logging console informational
username cisco
  group root-lr
  group cisco-support
  password 7 02050D4808565E731F1A
!
grpc
  port 57400
  no-tls
!
line console
  exec-timeout 0 0
  absolute-timeout 0
  session-timeout 0
!
line default
  exec-timeout 0 0
  absolute-timeout 0
  session-timeout 0
!
vty-pool default 0 99 line-template default
ntp
  server 10.4.33.51 burst iburst
!
alias fpd show hw-module fpd
alias plat show platform
alias alarm show alarms brief system active
call-home
  service active
  contact smart-licensing
  profile CiscoTAC-1
  active
  destination transport-method email disable
  destination transport-method http
!
!
netconf-yang agent
  ssh
!
```

```

.
.
snipped
.
.
!
!
interface PTP0/RP0/CPU0/0
 shutdown
!
interface PTP0/RP0/CPU0/1
 shutdown
!
router static
 address-family ipv4 unicast
  0.0.0.0/0 10.4.33.1
!
!
router ospf 1
 distribute link-state instance-id 0 throttle 5
 network point-to-point
 redistribute connected
 area 0
  interface Loopback0
  !
  interface GigabitEthernet0/0/0/0
  !
!
netconf agent tty
!
ssh server rate-limit 600
ssh server session-limit 110
ssh server v2
ssh server netconf vrf default
optical-line-control
 automatic-link-bringup

```

7. Use the following show commands to view the status of the optical applications that are running on OLT-C-SITE6:

```

RP/0/RP0/CPU0:OLT-C-SITE6#show olc apc
Mon Aug  1 12:23:46.224 UTC

Controller      : Ots0/0/0/0
APC Status     : IDLE

Node RID       : 10.121.1.1
Internal State : IDLE

Node RID       : 10.120.1.1
Internal State : IDLE
RP/0/RP0/CPU0:OLT-C-SITE6#show olc span-loss
Mon Aug  1 12:24:06.632 UTC

Controller name           : Ots0/0/0/0
Neighbour RID            : 10.120.1.1
Rx Span Loss              : 15.3 dB
Rx Span Loss (with pumps off) : NA
Rx Span Loss (with pumps off) measured at : NA
Estimated Rx Span Loss   : NA
Tx Span Loss              : 10.3 dB
Tx Span Loss (with pumps off) : NA
Tx Span Loss (with pumps off) measured at : NA
Estimated Tx Span Loss   : NA

```

```

RP/0/RP0/CPU0:OLT-C-SITE6#show olc gain-estimator
Mon Aug 1 12:23:50.246 UTC
Controller          : Ots0/0/0/0
Ingress Gain Estimator Status : IDLE
Ingress Estimated Gain      : 19.0 dB
Ingress Estimated Gain Mode  : Normal
Ingress Gain Estimation Timestamp : 2022-07-19 07:58:12

```

```

RP/0/RP0/CPU0:OLT-C-SITE6#show olc link-tuner
Mon Aug 1 12:24:00.355 UTC
Controller          : Ots0/0/0/0
Link Tuner Status   : OPERATIONAL
Last PSD computation: 2022-08-01 12:14:05

```

```

-----
Setpoint          : Computed PSD
                   (dBm/12.5 GHz)
-----S-----
01                -8.0
02                -8.0
03                -8.0
04                -8.0
05                -7.9
06                -7.9
07                -7.9
08                -7.9
09                -7.8
10                -7.8
11                -7.8
12                -7.8
13                -7.7
14                -7.7
15                -7.7
16                -7.6
17                -7.6
18                -7.6
19                -7.6
20                -7.5
21                -7.5
22                -7.5
23                -7.4
24                -7.4
25                -7.4
26                -7.4
27                -7.3
28                -7.3
29                -7.3
30                -7.3
31                -7.2
32                -7.2
33                -7.2

```

```
RP/0/RP0/CPU0:OLT-C-SITE6#
```

- Configure the optical cross-connects for OLT-C-SITE-3 and OLT-C-SITE6. We are going to create a single channel from OLT-C-SITE-3 to OLT-C-SITE6 . The channel is mapped to **193.925 THz**.

Configuration for OLT-C-SITE-3

```

RP/0/RP0/CPU0:OLT-C-SITE-3#config
Tue Jul 26 06:30:25.087 UTC
RP/0/RP0/CPU0:OLT-C-SITE-3(config)#hw-module location 0/0/NXR0 terminal-ampli grid-mode flex
RRP/0/RP0/CPU0:OLT-C-SITE-3(config-hwmod-olt-flexi)#channel-id 30 centre-freq 193.925 width 75
RP/0/RP0/CPU0:OLT-C-SITE-3(config-hwmod-olt-flexi)#commit
Tue Jul 26 06:33:03.824 UTC
RP/0/RP0/CPU0:OLT-C-SITE-3(config-hwmod-olt-flexi)#end

```

```

RP/0/RP0/CPU0:OLT-C-SITE-3#config
Tue Jul 26 06:33:29.885 UTC
RP/0/RP0/CPU0:OLT-C-SITE-3(config)#controller ots-Och 0/0/0/0/30
RP/0/RP0/CPU0:OLT-C-SITE-3(config-Ots)#add-drop-channel ots-Och 0/0/0/3/30
RP/0/RP0/CPU0:OLT-C-SITE-3(config-Ots)#commit
RP/0/RP0/CPU0:OLT-C-SITE-3(config-Ots)#end
RP/0/RP0/CPU0:OLT-C-SITE-3#sh hw-module location 0/0/NXR0 terminal-ampli
Mon Aug 1 12:36:23.954 UTC

```

```

Legend:
NXC - Channel not cross-connected
ACTIVE - Channel cross-connected to data port
ASE - Channel filled with ASE
FAILED - Data channel failed, pending transition to ASE

```

```

Location:          0/0/NXR0
Status:           Provisioned

```

Flex Grid Info

Channel Number	Centre Frequency (THz)	Channel Width (GHz)	Channel Status
30	193.925000	75.000	ACTIVE

```
RP/0/RP0/CPU0:OLT-C-SITE-3#
```

Configuration for OLT-C-SITE-6

```

RP/0/RP0/CPU0:OLT-C-SITE-6#config
Tue Jul 26 06:30:25.087 UTC
RP/0/RP0/CPU0:OLT-C-SITE-6(config)#hw-module location 0/0/NXR0 terminal-ampli grid-mode flex
RRP/0/RP0/CPU0:OLT-C-SITE-6(config-hwmod-olt-flexi)#channel-id 30 centre-freq 193.925 width 75
RP/0/RP0/CPU0:OLT-C-SITE-6(config-hwmod-olt-flexi)#commit
Tue Jul 26 06:33:03.824 UTC
RP/0/RP0/CPU0:OLT-C-SITE-6(config-hwmod-olt-flexi)#end

```

```

RP/0/RP0/CPU0:OLT-C-SITE-6#config
Mon Aug 1 12:42:09.686 UTC

```

```

RP/0/RP0/CPU0:OLT-C-SITE-6(config)#controller ots-Och 0/0/0/0/30
RP/0/RP0/CPU0:OLT-C-SITE-6(config-Ots)#add-drop-channel ots-Och 0/0/0/3/30
RP/0/RP0/CPU0:OLT-C-SITE-6(config-Ots)#commit
RP/0/RP0/CPU0:OLT-C-SITE-6(config-Ots)#end
RP/0/RP0/CPU0:OLT-C-SITE-6#sh hw-module location 0/0/NXR0 terminal-ampli
Mon Aug 1 12:36:23.954 UTC

```

```

Legend:
NXC - Channel not cross-connected
ACTIVE - Channel cross-connected to data port
ASE - Channel filled with ASE
FAILED - Data channel failed, pending transition to ASE

```

```

Location:          0/0/NXR0
Status:           Provisioned

```

Flex Grid Info

Channel Number	Centre Frequency (THz)	Channel Width (GHz)	Channel Status
30	193.925000	75.000	ACTIVE

```
RP/0/RP0/CPU0:OLT-C-SITE-6#
```

After the cross-connects are created on the OLT nodes, APC regulates the power on each node. The APC status moves from WORKING to IDLE when the process completes. Use the **show olc apc** command to view the status of the operation. The following samples are for OLT-C-SITE-3.

```
RP/0/RP0/CPU0:OLT-C-SITE-3#show olc apc
Mon Aug 1 12:33:15.671 UTC
```

```
Controller      : Ots0/0/0/0
APC Status      : WORKING
Correcting Node : 10.120.1.1
```

```
Node RID        : 10.120.1.1
Internal State   : CORRECTING
```

```
Node RID        : 10.121.1.1
Internal State   : DISCREPANCY
```

```
RP/0/RP0/CPU0:OLT-C-SITE-3#show olc apc
Mon Aug 1 12:39:57.187 UTC
```

```
Controller      : Ots0/0/0/0
APC Status      : IDLE
```

```
Node RID        : 10.120.1.1
Internal State   : IDLE
```

```
Node RID        : 10.121.1.1
Internal State   : IDLE
```

```
RP/0/RP0/CPU0:OLT-C-SITE-3#
```

After the APC process is complete, the link comes up. You can view the details using the **sh olc apc-local regulation-info controller ots** command on the near-end and far-end nodes.

OLT-C-SITE-3:

```
RP/0/RP0/CPU0:OLT-C-SITE-3#sh olc apc-local regulation-info controller ots 0/0/0/0 rx
Mon Aug 1 12:44:42.887 UTC
Controller      : Ots0/0/0/0
Domain Manager  : 10.121.1.1
Internal Status : IDLE
Direction      : RX
PSD Minimum     : -22.0 (dBm/12.5 GHz)
Gain Range      : Normal
Last Correction : 2022-08-01 12:35:29
```

Device Parameters		Min	Max	Configuration	Operational
Ingress Ampli Gain (dB)	:	12.0	25.0	17.7	17.7
Ingress Ampli Tilt (dB)	:	-5.0	3.4	0.4	0.4
RX Ampli Power (dBm)	:	-	25.0	-	24.5
RX VOA Attenuation (dB)	:	0.0	0.0	0.0	0.0
Ingress WSS/DGE Attenuation (dB)	:	0.0	25.0	-	-

Channel Center Slice Config	Channel Width (GHz)	Channel ID	Channel Source	Spectrum Slice Num	Ampli-Input PSD (dBm/12.5 GHz)	Target PSD (dBm/12.5 GHz)	Current PSD (dBm/12.5 GHz)	Discrepancy (dB)	Channel Attn (dB)
191.375000	75.00	-	ASE	13	-18.4	-	-25.6	0.0	25.0
191.449997	75.00	-	ASE	37	-18.3	-	-25.4	0.0	25.0
191.524994	75.00	-	ASE	61	-18.4	-	-25.7	0.0	25.0
191.600006	75.00	-	ASE	85	-18.3	-	-25.5	0.0	25.0
191.675003	75.00	-	ASE	109	-18.2	-	-25.5	0.0	25.0
191.750000	75.00	-	ASE	133	-18.2	-	-25.5	0.0	25.0
191.824997	75.00	-	ASE	157	-18.2	-	-25.5	0.0	25.0
191.899994	75.00	-	ASE	181	-18.1	-	-25.5	0.0	25.0
191.975006	75.00	-	ASE	205	-18.2	-	-25.6	0.0	25.0
192.050003	75.00	-	ASE	229	-18.1	-	-25.4	0.0	25.0
192.125000	75.00	-	ASE	253	-18.0	-	-25.4	0.0	25.0

192.199997	75.00	-	ASE	277	-18.1	-	-25.5	0.0	25.0
192.274994	75.00	-	ASE	301	-18.0	-	-25.5	0.0	25.0
192.350006	75.00	-	ASE	325	-18.0	-	-25.5	0.0	25.0
192.425003	75.00	-	ASE	349	-17.9	-	-25.4	0.0	25.0
192.500000	75.00	-	ASE	373	-18.0	-	-25.4	0.0	25.0
192.574997	75.00	-	ASE	397	-18.0	-	-25.5	0.0	25.0
192.649994	75.00	-	ASE	421	-18.0	-	-25.4	0.0	25.0
192.725006	75.00	-	ASE	445	-17.9	-	-25.3	0.0	25.0
192.800003	75.00	-	ASE	469	-17.8	-	-25.2	0.0	25.0
192.875000	75.00	-	ASE	493	-17.9	-	-25.4	0.0	25.0
192.949997	75.00	-	ASE	517	-17.9	-	-25.3	0.0	25.0
193.024994	75.00	-	ASE	541	-17.9	-	-25.4	0.0	25.0
193.100006	75.00	-	ASE	565	-17.9	-	-25.4	0.0	25.0
193.175003	75.00	-	ASE	589	-17.8	-	-25.4	0.0	25.0
193.250000	75.00	-	ASE	613	-17.9	-	-25.4	0.0	25.0
193.324997	75.00	-	ASE	637	-17.8	-	-25.3	0.0	25.0
193.399994	75.00	-	ASE	661	-17.7	-	-25.2	0.0	25.0
193.475006	75.00	-	ASE	685	-17.8	-	-25.3	0.0	25.0
193.550003	75.00	-	ASE	709	-17.9	-	-25.4	0.0	25.0
193.625000	75.00	-	ASE	733	-17.8	-	-25.3	0.0	25.0
193.699997	75.00	-	ASE	757	-17.7	-	-25.2	0.0	25.0
193.774994	75.00	-	ASE	781	-17.7	-	-25.1	0.0	25.0
193.850006	75.00	-	ASE	805	-17.7	-	-25.2	0.0	25.0
193.925003	75.00	30	Och	829	-18.0	-9.4	-9.1	-0.2	3.8
194.000000	75.00	-	ASE	853	-17.6	-	-25.1	0.0	25.0
194.074997	75.00	-	ASE	877	-17.6	-	-25.1	0.0	25.0
194.149994	75.00	-	ASE	901	-17.7	-	-25.1	0.0	25.0
194.225006	75.00	-	ASE	925	-17.7	-	-25.1	0.0	25.0
194.300003	75.00	-	ASE	949	-17.8	-	-25.1	0.0	25.0
194.375000	75.00	-	ASE	973	-17.6	-	-25.1	0.0	25.0
194.449997	75.00	-	ASE	997	-17.7	-	-25.0	0.0	25.0
194.524994	75.00	-	ASE	1021	-17.5	-	-25.0	0.0	25.0
194.600006	75.00	-	ASE	1045	-17.6	-	-25.1	0.0	25.0
194.675003	75.00	-	ASE	1069	-17.6	-	-25.0	0.0	25.0
194.750000	75.00	-	ASE	1093	-17.6	-	-25.0	0.0	25.0
194.824997	75.00	-	ASE	1117	-17.6	-	-25.2	0.0	25.0
194.899994	75.00	-	ASE	1141	-17.6	-	-25.2	0.0	25.0
194.975006	75.00	-	ASE	1165	-17.6	-	-25.3	0.0	25.0
195.050003	75.00	-	ASE	1189	-17.5	-	-25.3	0.0	25.0
195.125000	75.00	-	ASE	1213	-17.6	-	-25.5	0.0	25.0
195.199997	75.00	-	ASE	1237	-17.6	-	-25.7	0.0	25.0
195.274994	75.00	-	ASE	1261	-17.5	-	-25.7	0.0	25.0
195.350006	75.00	-	ASE	1285	-17.5	-	-25.7	0.0	25.0
195.425003	75.00	-	ASE	1309	-17.5	-	-25.8	0.0	25.0
195.500000	75.00	-	ASE	1333	-17.5	-	-25.9	0.0	25.0
195.574997	75.00	-	ASE	1357	-17.5	-	-25.8	0.0	25.0
195.649994	75.00	-	ASE	1381	-17.4	-	-25.7	0.0	25.0
195.725006	75.00	-	ASE	1405	-17.5	-	-25.7	0.0	25.0
195.800003	75.00	-	ASE	1429	-17.5	-	-25.6	0.0	25.0
195.875000	75.00	-	ASE	1453	-17.6	-	-25.6	0.0	25.0
195.949997	75.00	-	ASE	1477	-17.4	-	-25.4	0.0	25.0
196.024994	75.00	-	ASE	1501	-17.6	-	-25.4	0.0	25.0
196.100006	75.00	-	ASE	1525	-17.6	-	-25.3	0.0	25.0

ASE - Noise Loaded Channel
OCh - Optical Channel

RP/0/RP0/CPU0:OLT-C-SITE-3#

OLT-C-SITE-6:

```
RP/0/RP0/CPU0:OLT-C-SITE6#sh olc apc-local regulation-info controller ots 0/0/0/0 rx
Mon Aug 1 12:42:41.213 UTC
Controller      : Ots0/0/0/0
Domain Manager  : 10.120.1.1
Internal Status : IDLE
Direction      : RX
PSD Minimumum  : -22.0 (dBm/12.5 GHz)
Gain Range     : Normal
Last Correction : 2022-08-01 12:36:44
```

Device Parameters	Min	Max	Configuration	Operational
Ingress Ampli Gain (dB)	12.0	25.0	20.4	20.4
Ingress Ampli Tilt (dB)	-5.0	1.3	0.3	0.3
RX Ampli Power (dBm)	-	25.0	-	24.0
RX VOA Attenuation (dB)	0.0	0.0	0.0	0.0
Ingress WSS/DGE Attenuation (dB)	0.0	25.0	-	-

Channel Slice	Channel Center	Channel	Channel	Channel	Spectrum	Ampli-Input	Target	Current	Discrepancy	Channel

Frequency Config (THz)	Width (GHz)	ID	Source	Slice Num	PSD (dBm/12.5 GHz)	PSD (dBm/12.5 GHz)	PSD (dBm/12.5 GHz)	Attn (dB)	Attn (dB)
191.375000	75.00	-	ASE	13	-21.6	-	-25.6	0.0	25.0
191.449997	75.00	-	ASE	37	-21.5	-	-25.6	0.0	25.0
191.524994	75.00	-	ASE	61	-21.5	-	-25.6	0.0	25.0
191.600006	75.00	-	ASE	85	-21.5	-	-25.6	0.0	25.0
191.675003	75.00	-	ASE	109	-21.4	-	-25.6	0.0	25.0
191.750000	75.00	-	ASE	133	-21.6	-	-25.8	0.0	25.0
191.824997	75.00	-	ASE	157	-21.6	-	-25.8	0.0	25.0
191.899994	75.00	-	ASE	181	-21.5	-	-25.8	0.0	25.0
191.975006	75.00	-	ASE	205	-21.3	-	-25.7	0.0	25.0
192.050003	75.00	-	ASE	229	-21.4	-	-25.8	0.0	25.0
192.125000	75.00	-	ASE	253	-21.5	-	-25.9	0.0	25.0
192.199997	75.00	-	ASE	277	-21.4	-	-25.9	0.0	25.0
192.274994	75.00	-	ASE	301	-21.3	-	-25.8	0.0	25.0
192.350006	75.00	-	ASE	325	-21.3	-	-25.9	0.0	25.0
192.425003	75.00	-	ASE	349	-21.4	-	-26.0	0.0	25.0
192.500000	75.00	-	ASE	373	-21.3	-	-26.0	0.0	25.0
192.574997	75.00	-	ASE	397	-21.4	-	-26.0	0.0	25.0
192.649994	75.00	-	ASE	421	-21.3	-	-25.9	0.0	25.0
192.725006	75.00	-	ASE	445	-21.3	-	-26.0	0.0	25.0
192.800003	75.00	-	ASE	469	-21.3	-	-26.0	0.0	25.0
192.875000	75.00	-	ASE	493	-21.3	-	-26.0	0.0	25.0
192.949997	75.00	-	ASE	517	-21.3	-	-26.0	0.0	25.0
193.024994	75.00	-	ASE	541	-21.2	-	-25.8	0.0	25.0
193.100006	75.00	-	ASE	565	-21.3	-	-26.0	0.0	25.0
193.175003	75.00	-	ASE	589	-21.2	-	-26.0	0.0	25.0
193.250000	75.00	-	ASE	613	-21.2	-	-25.9	0.0	25.0
193.324997	75.00	-	ASE	637	-21.2	-	-25.9	0.0	25.0
193.399994	75.00	-	ASE	661	-21.3	-	-26.0	0.0	25.0
193.475006	75.00	-	ASE	685	-21.2	-	-25.9	0.0	25.0
193.550003	75.00	-	ASE	709	-21.1	-	-25.9	0.0	25.0
193.625000	75.00	-	ASE	733	-21.2	-	-25.9	0.0	25.0
193.699997	75.00	-	ASE	757	-21.2	-	-25.9	0.0	25.0
193.774994	75.00	-	ASE	781	-21.2	-	-25.9	0.0	25.0
193.850006	75.00	-	ASE	805	-21.1	-	-25.8	0.0	25.0
193.925003	75.00	30	Och	829	-21.2	-9.4	-9.4	0.0	2.1
194.000000	75.00	-	ASE	853	-21.1	-	-25.8	0.0	25.0
194.074997	75.00	-	ASE	877	-21.1	-	-25.8	0.0	25.0
194.149994	75.00	-	ASE	901	-21.0	-	-25.7	0.0	25.0
194.225006	75.00	-	ASE	925	-21.0	-	-25.7	0.0	25.0
194.300003	75.00	-	ASE	949	-21.0	-	-25.7	0.0	25.0
194.375000	75.00	-	ASE	973	-21.0	-	-25.7	0.0	25.0
194.449997	75.00	-	ASE	997	-21.0	-	-25.7	0.0	25.0
194.524994	75.00	-	ASE	1021	-21.0	-	-25.6	0.0	25.0
194.600006	75.00	-	ASE	1045	-21.0	-	-25.7	0.0	25.0
194.675003	75.00	-	ASE	1069	-21.0	-	-25.7	0.0	25.0
194.750000	75.00	-	ASE	1093	-21.0	-	-25.6	0.0	25.0
194.824997	75.00	-	ASE	1117	-20.8	-	-25.6	0.0	25.0
194.899994	75.00	-	ASE	1141	-20.9	-	-25.6	0.0	25.0
194.975006	75.00	-	ASE	1165	-21.0	-	-25.8	0.0	25.0
195.050003	75.00	-	ASE	1189	-20.9	-	-25.7	0.0	25.0
195.125000	75.00	-	ASE	1213	-20.8	-	-25.6	0.0	25.0
195.199997	75.00	-	ASE	1237	-20.7	-	-25.7	0.0	25.0
195.274994	75.00	-	ASE	1261	-20.8	-	-25.8	0.0	25.0
195.350006	75.00	-	ASE	1285	-20.9	-	-25.9	0.0	25.0
195.425003	75.00	-	ASE	1309	-20.7	-	-25.9	0.0	25.0
195.500000	75.00	-	ASE	1333	-20.7	-	-26.0	0.0	25.0
195.574997	75.00	-	ASE	1357	-20.6	-	-25.9	0.0	25.0
195.649994	75.00	-	ASE	1381	-20.6	-	-26.0	0.0	25.0
195.725006	75.00	-	ASE	1405	-20.7	-	-26.0	0.0	25.0
195.800003	75.00	-	ASE	1429	-20.6	-	-26.0	0.0	25.0
195.875000	75.00	-	ASE	1453	-20.6	-	-25.9	0.0	25.0
195.949997	75.00	-	ASE	1477	-20.5	-	-25.8	0.0	25.0
196.024994	75.00	-	ASE	1501	-20.6	-	-25.7	0.0	25.0
196.100006	75.00	-	ASE	1525	-20.5	-	-25.6	0.0	25.0

ASE - Noise Loaded Channel
Och - Optical Channel

RP/0/RP0/CPU0:OLT-C-SITE6#

Cross-connect Configuration

The OTS-OCH controllers are not created by default when the cards (NCS1K-ILA-2R-C, NCS1K-ILA-R-C, NCS1K-ILA-C, NCS1K-OLT-R-C, and NCS1K-OLT-C) are brought up. The LINE OTS-OCH controllers can be created using the **hw-module** command.

Optical Cross Connections can be configured only on OLT nodes. In these nodes, the OTS-OCH controller is not created automatically on the Add/Drop ports (COM side). The optical cross connect configuration defines the line side OTS-OCH channel as the source and creates an OTS-OCH controller on the ADD/Drop port to which the cross connection is made. The channel ID must be the same for both the LINE side and COM side OTS-OCH controller.

To illustrate the creation of the cross-connects, we are going to create a single channel from OLT-R-C-SITE-1 to OLT-C-SITE-8 in the topology diagram. The channel is mapped to **191.45 THz**.

Configuration for OLT-R-C-SITE-1

```
P/0/RP0/CPU0:OLT-R-C-SITE-1#config
Tue Jul 26 06:30:25.087 UTC
RP/0/RP0/CPU0:OLT-R-C-SITE-1(config)#hw-module location 0/0/NXR0 terminal-ampli grid-mode flex
RP/0/RP0/CPU0:OLT-R-C-SITE-1(config-hwmod-olt-flexi)#channel-id 63 centre-freq 191.45 width 75
RP/0/RP0/CPU0:OLT-R-C-SITE-1(config-hwmod-olt-flexi)#commit
Tue Jul 26 06:33:03.824 UTC
RP/0/RP0/CPU0:OLT-R-C-SITE-1(config-hwmod-olt-flexi)#end
RP/0/RP0/CPU0:OLT-R-C-SITE-1#sh hw-module location 0/0/NXR0 terminal-ampli
Tue Jul 26 06:33:13.093 UTC
```

Legend:

```
NXC - Channel not cross-connected
ACTIVE - Channel cross-connected to data port
ASE - Channel filled with ASE
FAILED - Data channel failed, pending transition to ASE
```

Location: 0/0/NXR0

Status: Provisioned

Flex Grid Info

Channel Number	Centre Frequency (THz)	Channel Width (GHz)	Channel Status
2	196.025000	75.000	ASE
17	194.900000	75.000	ACTIVE
63	191.450000	75.000	NXC

```
RP/0/RP0/CPU0:OLT-R-C-SITE-1#config
Tue Jul 26 06:33:29.885 UTC
RP/0/RP0/CPU0:OLT-R-C-SITE-1(config)#controller ots-Och 0/0/0/0/63
RP/0/RP0/CPU0:OLT-R-C-SITE-1(config-Ots)#add-drop-channel ots-Och 0/0/0/3/63
RP/0/RP0/CPU0:OLT-R-C-SITE-1(config-Ots)#commit
RP/0/RP0/CPU0:OLT-R-C-SITE-1(config-Ots)#end
RP/0/RP0/CPU0:OLT-R-C-SITE-1#sh hw-module location 0/0/NXR0 terminal-ampli
Tue Jul 26 06:34:27.110 UTC
```

Legend:

```
NXC - Channel not cross-connected
ACTIVE - Channel cross-connected to data port
ASE - Channel filled with ASE
FAILED - Data channel failed, pending transition to ASE
```

Location: 0/0/NXR0

Status: Provisioned

Flex Grid Info

Channel Number	Centre Frequency (THz)	Channel Width (GHz)	Channel Status
2	196.025000	75.000	ASE
17	194.900000	75.000	ACTIVE
63	191.450000	75.000	ACTIVE

Configuration for ILA-2R-C

```
RP/0/RP0/CPU0:ILA-2R-C#config
Tue Jul 26 06:35:12.145 UTC
RP/0/RP0/CPU0:ILA-2R-C(config)#hw-module location 0/0/NXR0 inline-ampli
RP/0/RP0/CPU0:ILA-2R-C(config-hwmod-ila)#grid-mode flex
RP/0/RP0/CPU0:ILA-2R-C(config-hwmod-ila-flexi)#channel-id 63 centre-freq 191.45 width 75
RP/0/RP0/CPU0:ILA-2R-C(config-hwmod-ila-flexi)#commit
RP/0/RP0/CPU0:ILA-2R-C(config-hwmod-ila-flexi)#end
RP/0/RP0/CPU0:ILA-2R-C#sh hw-module location 0/0/NXR0 inline-ampli
Tue Jul 26 06:36:33.333 UTC
```

```
Location:          0/0/NXR0
Status:            Provisioned
```

Flex Grid Info

Channel Number	Centre Frequency (THz)	Channel Width (GHz)
63	191.450000	75.000

```
RP/0/RP0/CPU0:ILA-2R-C#sh controllers ots-Och 0/0/0/0/63
Tue Jul 26 06:36:41.935 UTC
```

```
Controller State: Up
Transport Admin State: In Service
```

```
Alarm Status:
-----
Detected Alarms: None

Parameter Statistics:
-----
Total RX Power = -13.40 dBm
Total TX Power = 0.99 dBm
```

```
Configured Parameters:
-----
```

```
RP/0/RP0/CPU0:ILA-2R-C#sh controllers ots-Och 0/0/0/2/63
Tue Jul 26 06:36:52.466 UTC
```

```
Controller State: Up
Transport Admin State: In Service
```

```
Alarm Status:
-----
Detected Alarms: None

Parameter Statistics:
-----
Total RX Power = -5.50 dBm
Total TX Power = 2.29 dBm
```

```
Configured Parameters:
-----
```

Configuration for ILA-R-C

```
RP/0/RP0/CPU0:ILA-R-C#config
Tue Jul 26 06:36:45.377 UTC
RP/0/RP0/CPU0:ILA-R-C(config)#hw-module location 0/0/NXR0 inline-ampli grid-mode flex
RP/0/RP0/CPU0:ILA-R-C(config-hwmod-ila-flexi)#channel-id 63 centre-freq 191.45 width 75
RP/0/RP0/CPU0:ILA-R-C(config-hwmod-ila-flexi)#commit
RP/0/RP0/CPU0:ILA-R-C(config-hwmod-ila-flexi)#end
RP/0/RP0/CPU0:ILA-R-C#sh hw-module location 0/0/NXR0 inline-ampli
Tue Jul 26 06:37:08.127 UTC
```

Location: 0/0/NXR0

Status: Provisioned

Flex Grid Info

Channel Number	Centre Frequency (THz)	Channel Width (GHz)
63	191.450000	75.000

```
RP/0/RP0/CPU0:ILA-R-C#sh controllers ots-Och 0/0/0/0/63
Tue Jul 26 07:08:07.280 UTC
```

Controller State: Up

Transport Admin State: In Service

```
Alarm Status:
-----
Detected Alarms: None
```

```
Parameter Statistics:
-----
Total RX Power = -12.40 dBm
Total TX Power = 1.19 dBm
```

```
Configured Parameters:
-----
```

```
RP/0/RP0/CPU0:ILA-R-C#sh controllers ots-Och 0/0/0/2/63
Tue Jul 26 07:08:10.854 UTC
```

Controller State: Up

Transport Admin State: In Service

```
Alarm Status:
-----
Detected Alarms: None
```

```
Parameter Statistics:
-----
Total RX Power = -9.10 dBm
Total TX Power = 1.39 dBm
```

```
Configured Parameters:
-----
```

Configuration for ILA-C

```
RP/0/RP0/CPU0:ILA-C#config
Tue Jul 26 06:38:56.584 UTC
```

```
RP/0/RP0/CPU0:ILA-C(config)#hw-module location 0/0/NXR0 inline-ampli grid-mode flex
RP/0/RP0/CPU0:ILA-C(config-hwmod-ila-flexi)#channel-id 63 centre-freq 191.45 width 75
RP/0/RP0/CPU0:ILA-C(config-hwmod-ila-flexi)#commit
Tue Jul 26 06:39:24.378 UTC
RP/0/RP0/CPU0:ILA-C(config-hwmod-ila-flexi)#end
RP/0/RP0/CPU0:ILA-C#
RP/0/RP0/CPU0:ILA-C#sh hw-module location 0/0/NXR0 inline-ampli
Tue Jul 26 06:39:43.874 UTC
```

Location: 0/0/NXR0

Status: Provisioned

Flex Grid Info

Channel Number	Centre Frequency (THz)	Channel Width (GHz)
63	191.450000	75.000

```
RP/0/RP0/CPU0:ILA-C#sh controllers ots-Och 0/0/0/0/63
Tue Jul 26 07:10:32.333 UTC
```

Controller State: Up

Transport Admin State: In Service

Alarm Status:

Detected Alarms: None

Parameter Statistics:

Total RX Power = -15.80 dBm

Total TX Power = -0.60 dBm

Configured Parameters:

```
RP/0/RP0/CPU0:ILA-C#sh controllers ots-Och 0/0/0/2/63
Tue Jul 26 07:10:38.238 UTC
```

Controller State: Up

Transport Admin State: In Service

Alarm Status:

Detected Alarms: None

Parameter Statistics:

Total RX Power = -11.00 dBm

Total TX Power = -1.60 dBm

Configured Parameters:

Configuration for OLT-C-SITE-2

```
RP/0/RP0/CPU0:OLT-C-SITE-2#config
Tue Jul 26 06:38:54.139 UTC
RP/0/RP0/CPU0:OLT-C-SITE-2(config)#hw-module location 0/0/NXR0 terminal-ampli
RP/0/RP0/CPU0:OLT-C-SITE-2(config-hwmod-olt)#grid-mode flex
```

```
RP/0/RP0/CPU0:OLT-C-SITE-2(config-hwmod-olt-flexi)#channel-id 63 centre-freq 191.45 width 75
RP/0/RP0/CPU0:OLT-C-SITE-2(config-hwmod-olt-flexi)#commit
RP/0/RP0/CPU0:OLT-C-SITE-2(config-hwmod-olt-flexi)#end
RP/0/RP0/CPU0:OLT-C-SITE-2#sh hw-module location 0/0/NXR0 terminal-ampli
Tue Jul 26 06:39:23.878 UTC
```

Legend:

```
NXC - Channel not cross-connected
ACTIVE - Channel cross-connected to data port
ASE - Channel filled with ASE
FAILED - Data channel failed, pending transition to ASE
```

Location: 0/0/NXR0

Status: Provisioned

Flex Grid Info

Channel Number	Centre Frequency (THz)	Channel Width (GHz)	Channel Status
2	196.025000	75.000	ASE
17	194.900000	75.000	ACTIVE
63	191.450000	75.000	NXC

```
RP/0/RP0/CPU0:OLT-C-SITE-2#config
Tue Jul 26 06:48:25.732 UTC
RP/0/RP0/CPU0:OLT-C-SITE-2(config)#controller ots-Och 0/0/0/0/63
RP/0/RP0/CPU0:OLT-C-SITE-2(config-Ots)#add-drop-channel ots-Och 0/0/0/30/63
RP/0/RP0/CPU0:OLT-C-SITE-2(config-Ots)#commit
RP/0/RP0/CPU0:OLT-C-SITE-2(config-Ots)#end
RP/0/RP0/CPU0:OLT-C-SITE-2#sh controllers ots-Och 0/0/0/0/63
Tue Jul 26 07:10:28.928 UTC
```

Controller State: Up

Transport Admin State: In Service

```
Alarm Status:
-----
Detected Alarms: None
```

```
Parameter Statistics:
-----
Total RX Power = -11.80 dBm
Total TX Power = 0.99 dBm
```

```
Cross Connect Info:
-----
Add-Drop Channel = Ots-Och0/0/0/30/63
```

```
Configured Parameters:
-----
```

```
RP/0/RP0/CPU0:OLT-C-SITE-2#sh controllers ots-Och 0/0/0/30/63
Tue Jul 26 07:10:33.899 UTC
```

Controller State: Up

Transport Admin State: In Service

```
Alarm Status:
-----
```

Detected Alarms: None

Parameter Statistics:

Total RX Power = -4.50 dBm
Total TX Power = -2.20 dBm

Cross Connect Info:

line Channel = Ots-Och0/0/0/0/63

Configured Parameters:

Configuration for OLT-C-SITE-5

```
RP/0/RP0/CPU0:OLT-C-SITE-5#config
Tue Jul 26 06:50:27.739 UTC
Current Configuration Session Line      User      Date      Lock
00001000-000044b2-00000000    con0_RP0_C cisco    Fri Jul 22 11:53:12 2022
RP/0/RP0/CPU0:OLT-C-SITE-5(config)#hw-module location 0/0/NXR0 terminal-ampli grid-mode flex
RP/0/RP0/CPU0:OLT-C-SITE-5(config-hwmod-olt-flexi)#channel-id 63 centre-freq 191.45 width 75
RP/0/RP0/CPU0:OLT-C-SITE-5(config-hwmod-olt-flexi)#commit
Tue Jul 26 06:50:54.786 UTC
RP/0/RP0/CPU0:OLT-C-SITE-5(config-hwmod-olt-flexi)#end
RP/0/RP0/CPU0:OLT-C-SITE-5#sh hw-module location 0/0/NXR0 terminal-ampli
Tue Jul 26 06:51:01.966 UTC
```

Legend:

NXC - Channel not cross-connected
ACTIVE - Channel cross-connected to data port
ASE - Channel filled with ASE
FAILED - Data channel failed, pending transition to ASE

Location: 0/0/NXR0

Status: Provisioned

Flex Grid Info

Channel Number	Centre Frequency (THz)	Channel Width (GHz)	Channel Status
1	196.100000	75.000	ACTIVE
3	195.950000	75.000	ASE
5	195.800000	75.000	ASE
17	194.900000	75.000	ACTIVE
59	191.750000	75.000	ACTIVE
61	191.600000	75.000	ACTIVE
62	191.525000	75.000	ASE
63	191.450000	75.000	NXC
64	191.375000	75.000	ACTIVE

```
RP/0/RP0/CPU0:OLT-C-SITE-5#config
Tue Jul 26 06:51:05.833 UTC
Current Configuration Session Line      User      Date      Lock
00001000-000044b2-00000000    con0_RP0_C cisco    Fri Jul 22 11:53:12 2022
RP/0/RP0/CPU0:OLT-C-SITE-5(config)#controller ots-Och 0/0/0/0/63
RP/0/RP0/CPU0:OLT-C-SITE-5(config-Ots)#add-drop-channel ots-Och 0/0/0/30/63
RP/0/RP0/CPU0:OLT-C-SITE-5(config-Ots)#commit
RP/0/RP0/CPU0:OLT-C-SITE-5(config-Ots)#end
RP/0/RP0/CPU0:OLT-C-SITE-5#
RP/0/RP0/CPU0:OLT-C-SITE-5#sh controllers ots-Och 0/0/0/0/63
Tue Jul 26 07:12:50.904 UTC
```

Controller State: Up

Transport Admin State: In Service

Alarm Status:

Detected Alarms: None

Parameter Statistics:

Total RX Power = -11.00 dBm

Total TX Power = 1.89 dBm

Cross Connect Info:

Add-Drop Channel = Ots-Och0/0/0/30/63

Configured Parameters:

RP/0/RP0/CPU0:OLT-C-SITE-5#sh controllers ots-Och 0/0/0/30/63
Tue Jul 26 07:12:54.871 UTC

Controller State: Up

Transport Admin State: In Service

Alarm Status:

Detected Alarms: None

Parameter Statistics:

Total RX Power = -3.70 dBm

Total TX Power = -2.70 dBm

Cross Connect Info:

line Channel = Ots-Och0/0/0/0/63

Configured Parameters:

Configuration for OLT-C-SITE-8

RP/0/RP0/CPU0:OLT-C-SITE-8#config

Tue Jul 26 06:56:26.764 UTC

Current Configuration Session	Line	User	Date	Lock
-------------------------------	------	------	------	------

00001000-0000345b-00000000	con0_RP0_C	cisco	Fri Jul 22 11:54:38 2022	
----------------------------	------------	-------	--------------------------	--

RP/0/RP0/CPU0:OLT-C-SITE-8(config)#controller ots-Och 0/0/0/0/63

RP/0/RP0/CPU0:OLT-C-SITE-8(config-Ots)#add-drop-channel ots-Och 0/0/0/3/63

RP/0/RP0/CPU0:OLT-C-SITE-8(config-Ots)#commit

Tue Jul 26 06:56:46.290 UTC

RP/0/RP0/CPU0:OLT-C-SITE-8(config-Ots)#end

RP/0/RP0/CPU0:OLT-C-SITE-8#sh hw-module location 0/0/NXR0 terminal-ampli

Tue Jul 26 06:57:06.011 UTC

Legend:

NXC - Channel not cross-connected

ACTIVE - Channel cross-connected to data port

ASE - Channel filled with ASE
FAILED - Data channel failed, pending transition to ASE

Location: 0/0/NXR0

Status: Provisioned

Flex Grid Info

Channel Number	Centre Frequency (THz)	Channel Width (GHz)	Channel Status
1	196.100000	75.000	ACTIVE
3	195.950000	75.000	NXC
5	195.800000	75.000	ACTIVE
17	194.900000	75.000	ACTIVE
59	191.750000	75.000	ACTIVE
63	191.450000	75.000	ACTIVE
64	191.375000	75.000	ACTIVE

RP/0/RP0/CPU0:OLT-C-SITE-8#sh controllers ots-Och 0/0/0/0/63
Tue Jul 26 06:57:28.630 UTC

Controller State: Up

Transport Admin State: In Service

Alarm Status:

Detected Alarms: None

Parameter Statistics:

Total RX Power = -13.20 dBm

Total TX Power = -1.50 dBm

Cross Connect Info:

Add-Drop Channel = Ots-Och0/0/0/3/63

Configured Parameters:

RP/0/RP0/CPU0:OLT-C-SITE-8#sh controllers ots-Och 0/0/0/3/63
Tue Jul 26 06:57:35.129 UTC

Controller State: Up

Transport Admin State: Automatic In Service

Alarm Status:

Detected Alarms: None

Parameter Statistics:

Total RX Power = -7.50 dBm

Total TX Power = -21.80 dBm

Cross Connect Info:

line Channel = Ots-Och0/0/0/0/63

Configured Parameters:

After the cross-connects are created on the OLT nodes, APC regulates the power on each node. The APC status moves from WORKING to IDLE when the process completes. Use the **show olc apc** command to view the status of the operation. The following samples are for OLT-C-SITE-8.

RP/0/RP0/CPU0:OLT-C-SITE-8#sh olc apc
Tue Jul 26 06:57:16.020 UTC

Controller : Ots0/0/0/0
APC Status : WORKING
Correcting Node : 10.123.1.1

Node RID : 10.125.1.1
Internal State : IDLE

Node RID : 10.123.1.1
Internal State : CORRECTING

RP/0/RP0/CPU0:OLT-C-SITE-8#sh olc apc
Tue Jul 26 06:59:11.985 UTC

Controller : Ots0/0/0/0
APC Status : IDLE

Node RID : 10.125.1.1
Internal State : IDLE

Node RID : 10.123.1.1
Internal State : IDLE

After the APC process is complete, the link comes up. You can view the details using the **sh olc apc-local regulation-info controller ots** command on the near-end and far-end nodes.

OLT-R-C-SITE-1:

RP/0/RP0/CPU0:OLT-R-C-SITE-1#sh olc apc-local regulation-info controller ots 0/0/0/0
Tue Jul 26 07:02:57.244 UTC
Controller : Ots0/0/0/0
Domain Manager : 10.131.1.1
Internal Status : IDLE
Direction : TX
PSD Minimum : -22.0 (dBm/12.5 GHz)
Gain Range : Normal
Last Correction : 2022-07-26 06:34:43

Device Parameters		Min	Max	Configuration	Operational
Egress Ampli Gain (dB)	:	15.3	29.3	17.9	17.9
Egress Ampli Tilt (dB)	:	-5.0	4.3	-1.6	-1.6
TX Ampli Power (dBm)	:	-	22.3	-	21.6
TX VOA Attenuation (dB)	:	0.0	20.0	1.3	1.3
Egress WSS/DGE Attenuation (dB)	:	0.0	25.0	-	-

Channel Center Frequency (THz)	Channel Width (GHz)	Channel ID	Channel Source	Spectrum Slice Num	Ampli-Input PSD (dBm/12.5 GHz)	Target PSD (dBm/12.5 GHz)	Current PSD (dBm/12.5 GHz)	Discrepancy (dB)	Channel Slice Attn Config (dB)
191.375000	75.00	-	ASE	13	-21.2	-5.7	-5.7	0.0	7.3
191.449997	75.00	63	OCh	37	-21.5	-5.7	-5.9	0.2	19.0
191.524994	75.00	-	ASE	61	-21.3	-5.7	-5.7	0.0	7.3

191.600006	75.00	-	ASE	85	-21.2	-5.6	-5.6	0.0	7.3
191.675003	75.00	-	ASE	109	-21.2	-5.6	-5.6	0.0	7.4
191.750000	75.00	-	ASE	133	-21.1	-5.5	-5.5	0.0	7.3
191.824997	75.00	-	ASE	157	-21.1	-5.5	-5.5	0.0	7.3
191.899994	75.00	-	ASE	181	-21.1	-5.5	-5.5	0.0	7.3
191.975006	75.00	-	ASE	205	-21.2	-5.5	-5.5	0.0	7.4
192.050003	75.00	-	ASE	229	-21.1	-5.4	-5.4	0.0	7.2
192.125000	75.00	-	ASE	253	-21.1	-5.4	-5.4	0.0	7.2
192.199997	75.00	-	ASE	277	-21.0	-5.4	-5.4	0.0	7.2
192.274994	75.00	-	ASE	301	-21.1	-5.4	-5.4	0.0	7.2
192.350006	75.00	-	ASE	325	-21.0	-5.3	-5.3	0.0	7.0
192.425003	75.00	-	ASE	349	-21.0	-5.3	-5.3	0.0	6.9
192.500000	75.00	-	ASE	373	-21.0	-5.3	-5.4	0.1	7.0
192.574997	75.00	-	ASE	397	-20.9	-5.3	-5.3	0.0	7.0
192.649994	75.00	-	ASE	421	-20.9	-5.2	-5.2	0.0	7.0
192.725006	75.00	-	ASE	445	-20.9	-5.2	-5.2	0.0	6.9
192.800003	75.00	-	ASE	469	-20.9	-5.2	-5.2	0.0	6.9
192.875000	75.00	-	ASE	493	-20.9	-5.2	-5.2	0.0	6.9
192.949997	75.00	-	ASE	517	-20.8	-5.1	-5.1	0.0	6.8
193.024994	75.00	-	ASE	541	-20.9	-5.1	-5.1	0.0	6.8
193.100006	75.00	-	ASE	565	-20.9	-5.1	-5.1	0.0	6.7
193.175003	75.00	-	ASE	589	-20.9	-5.1	-5.1	0.0	6.6
193.250000	75.00	-	ASE	613	-20.8	-5.0	-5.0	0.0	6.5
193.324997	75.00	-	ASE	637	-20.9	-5.0	-5.1	0.0	6.6
193.399994	75.00	-	ASE	661	-20.8	-5.0	-5.0	0.0	6.5
193.475006	75.00	-	ASE	685	-20.9	-5.0	-5.0	0.0	6.5
193.550003	75.00	-	ASE	709	-20.9	-4.9	-4.9	0.0	6.5
193.625000	75.00	-	ASE	733	-20.9	-4.9	-4.9	0.0	6.5
193.699997	75.00	-	ASE	757	-20.9	-4.9	-4.9	0.0	6.5
193.774994	75.00	-	ASE	781	-21.0	-4.9	-4.9	0.0	6.6
193.850006	75.00	-	ASE	805	-20.9	-4.8	-4.8	0.0	6.5
193.925003	75.00	-	ASE	829	-21.0	-4.8	-4.8	0.0	6.6
194.000000	75.00	-	ASE	853	-21.0	-4.8	-4.8	0.0	6.6
194.074997	75.00	-	ASE	877	-21.0	-4.8	-4.7	0.0	6.6
194.149994	75.00	-	ASE	901	-21.0	-4.7	-4.7	0.0	6.7
194.225006	75.00	-	ASE	925	-21.0	-4.7	-4.7	0.0	6.8
194.300003	75.00	-	ASE	949	-21.1	-4.7	-4.7	0.0	6.9
194.375000	75.00	-	ASE	973	-21.0	-4.7	-4.6	0.0	6.9
194.449997	75.00	-	ASE	997	-21.0	-4.6	-4.6	0.0	6.9
194.524994	75.00	-	ASE	1021	-21.1	-4.6	-4.7	0.0	7.0
194.600006	75.00	-	ASE	1045	-21.1	-4.6	-4.6	0.0	6.9
194.675003	75.00	-	ASE	1069	-21.1	-4.6	-4.6	0.0	6.9
194.750000	75.00	-	ASE	1093	-21.1	-4.5	-4.5	0.0	6.8
194.824997	75.00	-	ASE	1117	-21.0	-4.5	-4.5	0.0	6.7
194.899994	75.00	17	OCh	1141	-21.2	-4.5	-4.5	0.0	19.5
194.975006	75.00	-	ASE	1165	-21.1	-4.5	-4.5	0.0	6.6
195.050003	75.00	-	ASE	1189	-21.0	-4.4	-4.4	0.0	6.4
195.125000	75.00	-	ASE	1213	-21.1	-4.4	-4.4	0.0	6.4
195.199997	75.00	-	ASE	1237	-21.1	-4.4	-4.4	0.0	6.3
195.274994	75.00	-	ASE	1261	-21.2	-4.4	-4.5	0.1	6.3
195.350006	75.00	-	ASE	1285	-21.2	-4.3	-4.3	0.0	6.2
195.425003	75.00	-	ASE	1309	-21.3	-4.3	-4.3	0.0	6.2
195.500000	75.00	-	ASE	1333	-21.3	-4.3	-4.3	0.0	6.2
195.574997	75.00	-	ASE	1357	-21.5	-4.3	-4.4	0.1	6.3
195.649994	75.00	-	ASE	1381	-21.5	-4.2	-4.3	0.0	6.4
195.725006	75.00	-	ASE	1405	-21.5	-4.2	-4.1	-0.1	6.5
195.800003	75.00	-	ASE	1429	-21.7	-4.2	-4.2	0.0	6.8
195.875000	75.00	-	ASE	1453	-21.9	-4.2	-4.3	0.1	7.1
195.949997	75.00	-	ASE	1477	-21.8	-4.2	-4.0	-0.1	7.1
196.024994	75.00	2	ASE	1501	-21.9	-4.1	-4.1	0.0	7.3
196.100006	75.00	-	ASE	1525	-21.9	-4.1	-4.0	-0.1	7.4

Controller : Ots0/0/0/0
Domain Manager : 10.126.1.1
Internal Status : IDLE
Direction : RX
PSD Minimum : -22.0 (dBm/12.5 GHz)
Gain Range : Normal
Last Correction : 2022-07-26 06:57:17

Device Parameters		Min	Max	Configuration	Operational
=====					
Ingress Ampli Gain (dB)	:	10.9	23.9	10.9	10.9
Ingress Ampli Tilt (dB)	:	-5.0	5.0	-1.6	-1.6
RX Ampli Power (dBm)	:	-	25.0	-	24.2
RX VOA Attenuation (dB)	:	0.0	0.0	0.0	0.0
Ingress WSS/DGE Attenuation (dB)	:	0.0	25.0	-	-

Channel Center Frequency (THz)	Channel Width (GHz)	Channel ID	Channel Source	Spectrum Slice Num	Ampli-Input PSD (dBm/12.5 GHz)	Target PSD (dBm/12.5 GHz)	Current PSD (dBm/12.5 GHz)	Discrepancy (dB)	Channel Slice Attn Config (dB)
=====									

191.375000	75.00	-	ASE	13	-11.1	-	-25.5	0.0	25.0
191.449997	75.00	63	OCh	37	-11.1	-8.0	-8.1	0.0	2.9
191.524994	75.00	-	ASE	61	-11.0	-	-25.4	0.0	25.0
191.600006	75.00	-	ASE	85	-11.0	-	-25.2	0.0	25.0
191.675003	75.00	-	ASE	109	-11.0	-	-25.3	0.0	25.0
191.750000	75.00	-	ASE	133	-11.0	-	-25.4	0.0	25.0
191.824997	75.00	-	ASE	157	-11.4	-	-25.6	0.0	25.0
191.899994	75.00	-	ASE	181	-11.4	-	-25.6	0.0	25.0
191.975006	75.00	-	ASE	205	-11.1	-	-25.4	0.0	25.0
192.050003	75.00	-	ASE	229	-11.0	-	-25.3	0.0	25.0
192.125000	75.00	-	ASE	253	-11.1	-	-25.4	0.0	25.0
192.199997	75.00	-	ASE	277	-11.4	-	-25.6	0.0	25.0
192.274994	75.00	-	ASE	301	-11.5	-	-25.7	0.0	25.0
192.350006	75.00	-	ASE	325	-11.3	-	-25.7	0.0	25.0
192.425003	75.00	-	ASE	349	-11.5	-	-25.7	0.0	25.0
192.500000	75.00	-	ASE	373	-11.6	-	-25.8	0.0	25.0
192.574997	75.00	-	ASE	397	-11.6	-	-25.7	0.0	25.0
192.649994	75.00	-	ASE	421	-11.7	-	-25.9	0.0	25.0
192.725006	75.00	-	ASE	445	-11.8	-	-26.1	0.0	25.0
192.800003	75.00	-	ASE	469	-11.9	-	-26.1	0.0	25.0
192.875000	75.00	-	ASE	493	-11.8	-	-26.0	0.0	25.0
192.949997	75.00	-	ASE	517	-12.0	-	-26.2	0.0	25.0
193.024994	75.00	-	ASE	541	-12.0	-	-26.1	0.0	25.0
193.100006	75.00	-	ASE	565	-11.9	-	-26.1	0.0	25.0
193.175003	75.00	-	ASE	589	-12.0	-	-26.3	0.0	25.0
193.250000	75.00	-	ASE	613	-11.9	-	-26.1	0.0	25.0
193.324997	75.00	-	ASE	637	-11.9	-	-26.1	0.0	25.0
193.399994	75.00	-	ASE	661	-12.0	-	-26.2	0.0	25.0
193.475006	75.00	-	ASE	685	-12.0	-	-26.2	0.0	25.0
193.550003	75.00	-	ASE	709	-12.0	-	-26.1	0.0	25.0
193.625000	75.00	-	ASE	733	-11.9	-	-26.0	0.0	25.0
193.699997	75.00	-	ASE	757	-11.6	-	-25.8	0.0	25.0
193.774994	75.00	-	ASE	781	-11.6	-	-25.7	0.0	25.0
193.850006	75.00	-	ASE	805	-11.5	-	-25.6	0.0	25.0
193.925003	75.00	-	ASE	829	-11.4	-	-25.6	0.0	25.0
194.000000	75.00	-	ASE	853	-11.5	-	-25.6	0.0	25.0
194.074997	75.00	-	ASE	877	-11.6	-	-25.6	0.0	25.0
194.149994	75.00	-	ASE	901	-11.7	-	-25.6	0.0	25.0
194.225006	75.00	-	ASE	925	-11.8	-	-25.6	0.0	25.0
194.300003	75.00	-	ASE	949	-12.0	-	-25.8	0.0	25.0
194.375000	75.00	-	ASE	973	-12.0	-	-25.8	0.0	25.0
194.449997	75.00	-	ASE	997	-12.1	-	-25.9	0.0	25.0
194.524994	75.00	-	ASE	1021	-12.2	-	-25.9	0.0	25.0
194.600006	75.00	-	ASE	1045	-12.2	-	-26.0	0.0	25.0
194.675003	75.00	-	ASE	1069	-12.2	-	-26.0	0.0	25.0
194.750000	75.00	-	ASE	1093	-12.3	-	-26.0	0.0	25.0
194.824997	75.00	-	ASE	1117	-12.4	-	-26.1	0.0	25.0
194.899994	75.00	17	OCh	1141	-12.3	-8.0	-8.1	-0.1	2.0
194.975006	75.00	-	ASE	1165	-12.1	-	-26.0	0.0	25.0
195.050003	75.00	-	ASE	1189	-12.0	-	-25.9	0.0	25.0
195.125000	75.00	-	ASE	1213	-12.0	-	-25.9	0.0	25.0
195.199997	75.00	-	ASE	1237	-12.0	-	-26.0	0.0	25.0
195.274994	75.00	-	ASE	1261	-11.8	-	-25.7	0.0	25.0
195.350006	75.00	-	ASE	1285	-11.7	-	-25.6	0.0	25.0
195.425003	75.00	-	ASE	1309	-11.6	-	-25.5	0.0	25.0
195.500000	75.00	-	ASE	1333	-11.7	-	-25.6	0.0	25.0
195.574997	75.00	-	ASE	1357	-11.8	-	-25.4	0.0	25.0
195.649994	75.00	-	ASE	1381	-11.4	-	-25.1	0.0	25.0
195.725006	75.00	-	ASE	1405	-11.5	-	-25.1	0.0	25.0
195.800003	75.00	-	ASE	1429	-11.7	-	-25.1	0.0	25.0
195.875000	75.00	-	ASE	1453	-11.8	-	-25.0	0.0	25.0
195.949997	75.00	-	ASE	1477	-11.6	-	-24.7	0.0	25.0
196.024994	75.00	2	ASE	1501	-11.9	-9.0	-8.9	-0.1	4.5
196.100006	75.00	-	ASE	1525	-11.9	-	-24.8	0.0	25.0

OLT-C-SITE-8:

```

RF/0/RP0/CPU0:OLT-C-SITE-8#sh olc apc-local regulation-info controller ots 0/0/0/0 tX
Tue Jul 26 06:59:33.786 UTC
Controller      : Ots0/0/0/0
Domain Manager  : 10.125.1.1
Internal Status : IDLE
Direction      : TX
PSD Minumum    : -24.0 (dBm/12.5 GHz)
Gain Range      : Normal
Last Correction : 2022-07-26 06:57:09

```

Device Parameters	Min	Max	Configuration	Operational
Egress Ampli Gain (dB)	16.0	30.0	20.3	20.3
Egress Ampli Tilt (dB)	-5.0	3.0	-1.5	-1.5
TX Ampli Power (dBm)	-	23.0	-	22.1
TX VOA Attenuation (dB)	0.0	20.0	5.5	5.5
Egress WSS/DGE Attenuation (dB)	0.0	25.0	-	-

Channel Center Frequency (THz)	Channel Width (GHz)	Channel ID	Channel Source	Spectrum Slice Num	Ampli-Input PSD (dBm/12.5 GHz)	Target PSD (dBm/12.5 GHz)	Current PSD (dBm/12.5 GHz)	Discrepancy (dB)	Channel Slice Attn Config (dB)
191.375000	75.00	64	OCh	13	-23.0	-8.6	-8.6	0.0	20.2
191.449997	75.00	63	OCh	37	-23.0	-8.6	-8.6	0.0	18.3
191.524994	75.00	-	ASE	61	-23.0	-8.6	-8.6	0.0	7.7
191.600006	75.00	-	ASE	85	-23.1	-8.6	-8.7	0.1	7.8
191.675003	75.00	-	ASE	109	-23.0	-8.6	-8.6	0.0	7.6
191.750000	75.00	59	OCh	133	-23.0	-8.5	-8.6	0.0	20.0
191.824997	75.00	-	ASE	157	-23.1	-8.5	-8.5	0.0	7.8
191.899994	75.00	-	ASE	181	-23.0	-8.5	-8.5	0.0	7.7
191.975006	75.00	-	ASE	205	-23.0	-8.5	-8.5	0.0	7.7
192.050003	75.00	-	ASE	229	-23.0	-8.4	-8.4	0.0	7.6
192.125000	75.00	-	ASE	253	-23.0	-8.4	-8.5	0.0	7.7
192.199997	75.00	-	ASE	277	-23.1	-8.4	-8.5	0.1	7.8
192.274994	75.00	-	ASE	301	-22.9	-8.4	-8.3	0.0	7.6
192.350006	75.00	-	ASE	325	-22.9	-8.3	-8.4	0.0	7.5
192.425003	75.00	-	ASE	349	-22.9	-8.3	-8.3	0.0	7.5
192.500000	75.00	-	ASE	373	-22.8	-8.3	-8.3	0.0	7.5
192.574997	75.00	-	ASE	397	-23.0	-8.3	-8.4	0.1	7.6
192.649994	75.00	-	ASE	421	-22.8	-8.2	-8.2	0.0	7.4
192.725006	75.00	-	ASE	445	-22.8	-8.2	-8.3	0.0	7.4
192.800003	75.00	-	ASE	469	-22.9	-8.2	-8.3	0.1	7.5
192.875000	75.00	-	ASE	493	-22.8	-8.2	-8.3	0.1	7.5
192.949997	75.00	-	ASE	517	-22.7	-8.1	-8.0	-0.1	7.3
193.024994	75.00	-	ASE	541	-22.7	-8.1	-8.2	0.0	7.3
193.100006	75.00	-	ASE	565	-22.7	-8.1	-8.1	0.0	7.2
193.175003	75.00	-	ASE	589	-22.7	-8.1	-8.2	0.1	7.2
193.250000	75.00	-	ASE	613	-22.7	-8.1	-8.1	0.0	7.2
193.324997	75.00	-	ASE	637	-22.6	-8.0	-8.0	0.0	7.0
193.399994	75.00	-	ASE	661	-22.7	-8.0	-8.1	0.0	7.1
193.475006	75.00	-	ASE	685	-22.7	-8.0	-8.0	0.0	7.1
193.550003	75.00	-	ASE	709	-22.6	-8.0	-7.9	0.0	7.1
193.625000	75.00	-	ASE	733	-22.6	-7.9	-7.9	0.0	7.1
193.699997	75.00	-	ASE	757	-22.7	-7.9	-7.9	0.0	7.1
193.774994	75.00	-	ASE	781	-22.6	-7.9	-7.9	0.0	7.0
193.850006	75.00	-	ASE	805	-22.8	-7.9	-8.0	0.1	7.2
193.925003	75.00	-	ASE	829	-22.6	-7.8	-7.8	0.0	7.0
194.000000	75.00	-	ASE	853	-22.8	-7.8	-8.0	0.1	7.1
194.074997	75.00	-	ASE	877	-22.7	-7.8	-7.8	0.0	7.1
194.149994	75.00	-	ASE	901	-22.8	-7.8	-7.8	0.0	7.2
194.225006	75.00	-	ASE	925	-22.8	-7.8	-7.8	0.0	7.2
194.300003	75.00	-	ASE	949	-22.9	-7.7	-7.8	0.0	7.3
194.375000	75.00	-	ASE	973	-22.8	-7.7	-7.7	0.0	7.3
194.449997	75.00	-	ASE	997	-22.9	-7.7	-7.8	0.1	7.4
194.524994	75.00	-	ASE	1021	-22.7	-7.7	-7.5	-0.1	7.2
194.600006	75.00	-	ASE	1045	-22.8	-7.6	-7.6	0.0	7.3
194.675003	75.00	-	ASE	1069	-22.8	-7.6	-7.6	0.0	7.3
194.750000	75.00	-	ASE	1093	-22.8	-7.6	-7.6	0.0	7.2
194.824997	75.00	-	ASE	1117	-22.8	-7.6	-7.5	0.0	7.1
194.899994	75.00	17	OCh	1141	-22.9	-7.5	-7.5	0.0	18.8
194.975006	75.00	-	ASE	1165	-22.8	-7.5	-7.5	0.0	7.0
195.050003	75.00	-	ASE	1189	-22.9	-7.5	-7.5	0.0	7.1
195.125000	75.00	-	ASE	1213	-22.8	-7.5	-7.4	0.0	6.9
195.199997	75.00	-	ASE	1237	-22.9	-7.4	-7.4	0.0	6.8
195.274994	75.00	-	ASE	1261	-22.9	-7.4	-7.4	0.0	6.8
195.350006	75.00	-	ASE	1285	-23.0	-7.4	-7.4	0.0	6.9
195.425003	75.00	-	ASE	1309	-23.1	-7.4	-7.4	0.0	7.0
195.500000	75.00	-	ASE	1333	-23.1	-7.3	-7.4	0.0	6.8
195.574997	75.00	-	ASE	1357	-23.1	-7.3	-7.3	0.0	6.8
195.649994	75.00	-	ASE	1381	-23.3	-7.3	-7.4	0.1	7.0
195.725006	75.00	-	ASE	1405	-23.3	-7.3	-7.4	0.1	7.1
195.800003	75.00	5	OCh	1429	-23.3	-7.2	-7.2	0.0	19.1
195.875000	75.00	-	ASE	1453	-23.5	-7.2	-7.2	0.0	7.3
195.949997	75.00	-	ASE	1477	-23.6	-7.2	-7.2	0.0	7.4
196.024994	75.00	-	ASE	1501	-23.8	-7.2	-7.3	0.1	7.6
196.100006	75.00	1	OCh	1525	-23.7	-7.2	-7.1	0.0	19.4

ASE - Noise Loaded Channel
OCh - Optical Channel

RP/0/RP0/CPU0:OLT-C-SITE-8#sh olc apc-local regulation-info controller ots 0/0/0/0 rx
Tue Jul 26 06:59:42.151 UTC
Controller : Ots0/0/0/0
Domain Manager : 10.123.1.1
Internal Status : DISCREPANCY
Direction : RX
PSD Minimum : -24.0 (dBm/12.5 GHz)
Gain Range : Normal
Last Correction : 2022-07-26 06:59:39

Device Parameters	Min	Max	Configuration	Operational
Ingress Ampli Gain (dB)	: 12.0	25.0	19.7	19.7
Ingress Ampli Tilt (dB)	: -5.0	1.8	0.4	0.4
RX Ampli Power (dBm)	: -	25.0	-	24.2
RX VOA Attenuation (dB)	: 0.0	0.0	0.0	0.0
Ingress WSS/DGE Attenuation (dB)	: 0.0	25.0	-	-

Channel Center Frequency (THz)	Channel Width (GHz)	Channel ID	Channel Source	Spectrum Slice Num	Ampli-Input PSD (dBm/12.5 GHz)	Target PSD (dBm/12.5 GHz)	Current PSD (dBm/12.5 GHz)	Discrepancy (dB)	Channel Slice Attn Config (dB)
191.375000	75.00	64	OCh	13	-20.7	-8.0	-8.1	0.1	5.1
191.449997	75.00	63	OCh	37	-20.6	-8.0	-22.4	14.4	15.3
191.524994	75.00	62	ASE	61	-20.6	-	-25.6	0.0	25.0
191.600006	75.00	61	OCh	85	-20.6	-	-25.6	0.0	25.0
191.675003	75.00	-	ASE	109	-20.4	-	-25.4	0.0	25.0
191.750000	75.00	59	OCh	133	-20.4	-8.0	-8.1	0.0	5.4
191.824997	75.00	-	ASE	157	-20.4	-	-25.4	0.0	25.0
191.899994	75.00	-	ASE	181	-20.5	-	-25.5	0.0	25.0
191.975006	75.00	-	ASE	205	-20.4	-	-25.4	0.0	25.0
192.050003	75.00	-	ASE	229	-20.4	-	-25.4	0.0	25.0
192.125000	75.00	-	ASE	253	-20.3	-	-25.3	0.0	25.0
192.199997	75.00	-	ASE	277	-20.4	-	-25.4	0.0	25.0
192.274994	75.00	-	ASE	301	-20.5	-	-25.4	0.0	25.0
192.350006	75.00	-	ASE	325	-20.1	-	-25.2	0.0	25.0
192.425003	75.00	-	ASE	349	-20.2	-	-25.3	0.0	25.0
192.500000	75.00	-	ASE	373	-20.3	-	-25.3	0.0	25.0
192.574997	75.00	-	ASE	397	-20.4	-	-25.4	0.0	25.0
192.649994	75.00	-	ASE	421	-20.4	-	-25.3	0.0	25.0
192.725006	75.00	-	ASE	445	-20.3	-	-25.3	0.0	25.0
192.800003	75.00	-	ASE	469	-20.3	-	-25.3	0.0	25.0
192.875000	75.00	-	ASE	493	-20.3	-	-25.4	0.0	25.0
192.949997	75.00	-	ASE	517	-20.3	-	-25.3	0.0	25.0
193.024994	75.00	-	ASE	541	-20.2	-	-25.3	0.0	25.0
193.100006	75.00	-	ASE	565	-20.3	-	-25.4	0.0	25.0
193.175003	75.00	-	ASE	589	-20.3	-	-25.3	0.0	25.0
193.250000	75.00	-	ASE	613	-20.3	-	-25.5	0.0	25.0
193.324997	75.00	-	ASE	637	-20.2	-	-25.3	0.0	25.0
193.399994	75.00	-	ASE	661	-20.4	-	-25.5	0.0	25.0
193.475006	75.00	-	ASE	685	-20.4	-	-25.5	0.0	25.0
193.550003	75.00	-	ASE	709	-20.5	-	-25.6	0.0	25.0
193.625000	75.00	-	ASE	733	-20.4	-	-25.5	0.0	25.0
193.699997	75.00	-	ASE	757	-20.3	-	-25.4	0.0	25.0
193.774994	75.00	-	ASE	781	-20.4	-	-25.5	0.0	25.0
193.850006	75.00	-	ASE	805	-20.4	-	-25.5	0.0	25.0
193.925003	75.00	-	ASE	829	-20.3	-	-25.4	0.0	25.0
194.000000	75.00	-	ASE	853	-20.3	-	-25.4	0.0	25.0
194.074997	75.00	-	ASE	877	-20.4	-	-25.5	0.0	25.0
194.149994	75.00	-	ASE	901	-20.5	-	-25.5	0.0	25.0
194.225006	75.00	-	ASE	925	-20.4	-	-25.4	0.0	25.0
194.300003	75.00	-	ASE	949	-20.4	-	-25.5	0.0	25.0
194.375000	75.00	-	ASE	973	-20.4	-	-25.4	0.0	25.0
194.449997	75.00	-	ASE	997	-20.4	-	-25.5	0.0	25.0
194.524994	75.00	-	ASE	1021	-20.4	-	-25.4	0.0	25.0
194.600006	75.00	-	ASE	1045	-20.4	-	-25.4	0.0	25.0
194.675003	75.00	-	ASE	1069	-20.4	-	-25.5	0.0	25.0
194.750000	75.00	-	ASE	1093	-20.4	-	-25.4	0.0	25.0
194.824997	75.00	-	ASE	1117	-20.4	-	-25.4	0.0	25.0
194.899994	75.00	17	OCh	1141	-20.2	-8.0	-8.0	0.0	2.1
194.975006	75.00	-	ASE	1165	-20.3	-	-25.5	0.0	25.0
195.050003	75.00	-	ASE	1189	-20.2	-	-25.5	0.0	25.0
195.125000	75.00	-	ASE	1213	-20.3	-	-25.6	0.0	25.0
195.199997	75.00	-	ASE	1237	-20.3	-	-25.6	0.0	25.0
195.274994	75.00	-	ASE	1261	-20.2	-	-25.6	0.0	25.0
195.350006	75.00	-	ASE	1285	-20.2	-	-25.6	0.0	25.0
195.425003	75.00	-	ASE	1309	-20.0	-	-25.5	0.0	25.0
195.500000	75.00	-	ASE	1333	-20.1	-	-25.6	0.0	25.0
195.574997	75.00	-	ASE	1357	-20.1	-	-25.6	0.0	25.0
195.649994	75.00	-	ASE	1381	-19.9	-	-25.5	0.0	25.0
195.725006	75.00	-	ASE	1405	-19.8	-	-25.4	0.0	25.0
195.800003	75.00	5	ASE	1429	-19.9	-8.0	-7.9	0.0	1.8
195.875000	75.00	-	ASE	1453	-19.8	-	-25.3	0.0	25.0
195.949997	75.00	3	ASE	1477	-19.7	-	-25.2	0.0	25.0
196.024994	75.00	-	ASE	1501	-19.7	-	-25.0	0.0	25.0
196.100006	75.00	1	OCh	1525	-19.5	-8.0	-8.1	0.0	6.0

ASE - Noise Loaded Channel
OCh - Optical Channel

Monitoring and Troubleshooting the Network

This section details processes that monitor and troubleshoot the network.

- **OTDR:** The OTDR application is a built-in functionality in ILA and OLT devices. The OTDR measurement result is available in a SOR file format and it can be exported from NCS 1010 using SCP, TFTP, and SFTP format. The results can be used to find defects and faults, and determines the amount of signal loss at any point in an optical fiber.

```
RP/0/RP0/CPU0:OLT-C-R-SITE-1#otdr-start controller ots 0/0/0/0 tx
Tue Jul 26 08:13:09.744 UTC
OTS OTDR Scan Started at TX
```

```
RP/0/RP0/CPU0:OLT-C-R-SITE-1#sh controllers ots0/0/0/0 otdr-info tx
Tue Jul 26 08:14:43.541 UTC
```

Scan Direction: TX

Scan Status: Measuring

Event Type Legend: NR:Non-Reflective R:Reflective FE:Fiber-End ER:Excess-Reflection

```
RP/0/RP0/CPU0:OLT-C-R-SITE-1#sh controllers ots0/0/0/0 otdr-info tx
Tue Jul 26 08:16:53.287 UTC
```

Scan Direction: TX

Scan Status: Data Ready

SOR file: /harddisk:/otdr/OLT-C-R-SITE-1_NCS1010_OTDR_Ots0_0_0_0_TX_20220726-081525.sor

Total Events detected: 5

Scan Timestamp: Tue Jul 26 08:15:25 2022 UTC

Event Type Legend: NR:Non-Reflective R:Reflective FE:Fiber-End ER:Excess-Reflection

Event#	Detected Event(s)	Location (m)	Accuracy (m)	Magnitude (dB)
1	R ER	50379.9200	52.37	-15.00
0.20				
2	NR ER	50379.9200	52.37	2.57
0.20				
3	R	100711.2200	102.71	-38.21
0.14				
4	R FE ER	125778.8700	127.77	-24.35
-0.18				
5	NR FE ER	125778.8700	127.77	18.56
-0.18				

The SOR file can be viewed using third-party equipment. The following is a sample of a SOR file.

Figure 7: Sample SOR File

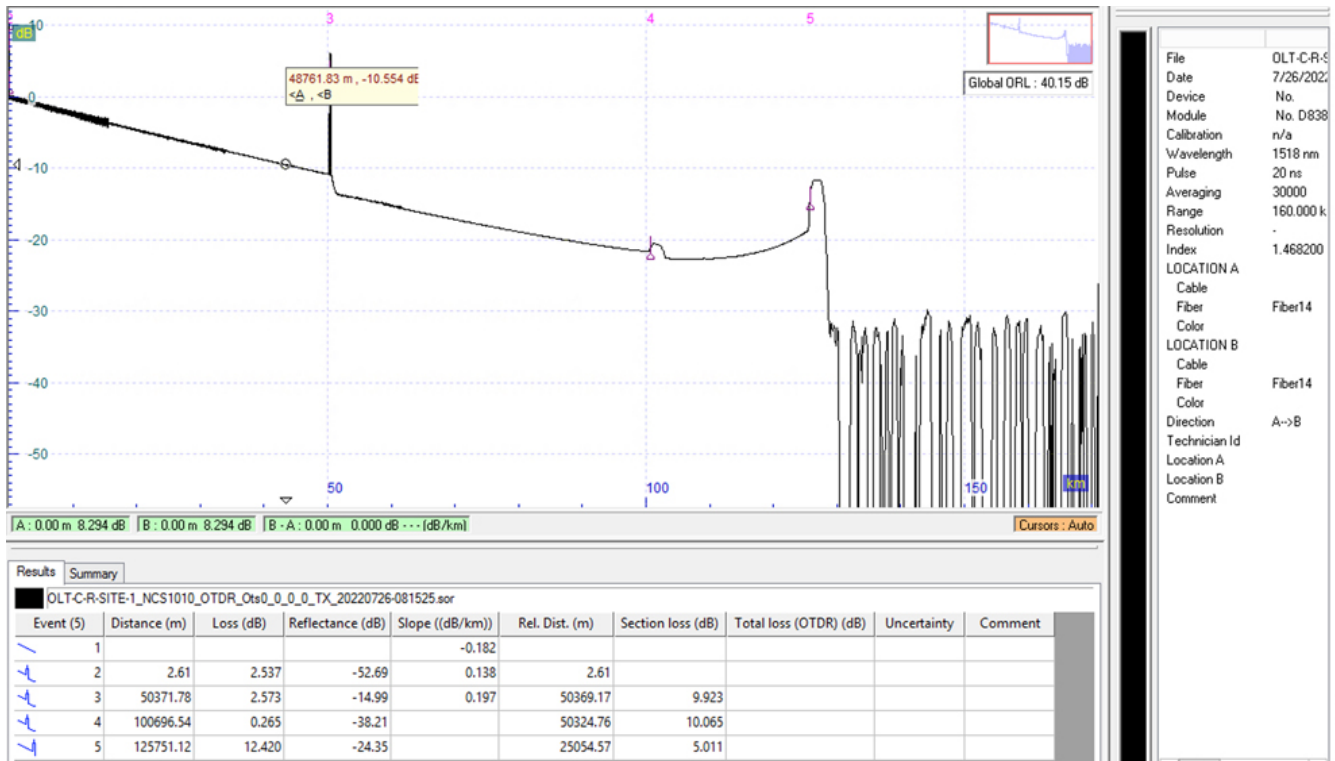

522707

- **tech-support command:** Use the **tech-support** CLI command to gather logs and traces.

```
RP/0/RP0/CPU0:OLT-C-R-SITE-4#sh tech-support ncs1010 detail
Tue Jul 26 08:09:06.848 UTC
++ Show tech start time: 2022-Jul-26.080907.UTC ++
Tue Jul 26 08:09:07 UTC 2022 Waiting for gathering to complete
.....
Tue Jul 26 08:16:05 UTC 2022 Compressing show tech output
Show tech output available at 0/RP0/CPU0 :
/harddisk:/showtech/showtech-OLT-C-R-SITE-4-ncs1010-2022-Jul-26.080907.UTC.tgz
++ Show tech end time: 2022-Jul-26.081606.UTC ++
```

- **Streaming Telemetry :** Telemetry is an automated communications process that you use to collect measurements and other data at remote or inaccessible points and transmit to receiving equipment for monitoring. Model-driven telemetry(MDT) provides a mechanism to stream YANG-modeled data to a data collector. Model-driven telemetry allows network devices to continuously stream real-time configuration and operating state information to subscribers.

Applications can subscribe to specific data items they need, by using standards-based YANG data models over gRPC Network Management Interface (gNMI) protocols. Devices publish structured data at a defined cadence, or on-change, based on the subscription criteria and data type.

This telemetry data can be used for analysis and troubleshooting purposes to maintain the health of the network.

This table lists the streaming telemetry sensor paths that are supported for NCS 1010.

Table 3: Supported Sensor Paths in NCS 1010

Sensor Paths
Cisco-IOS-XR-controller-ots-oper:ots-oper/ots-ports/ots-port/ots-info

Sensor Paths
Cisco-IOS-XR-controller-ots-oper:ots-oper/ots-ports/ots-port/ots-spectrum-info
Cisco-IOS-XR-controller-osc-oper:osc-oper/osc-ports/osc-port
Cisco-IOS-XR-controller-oms-oper:oms-oper/oms-ports/oms-port
Cisco-IOS-XR-controller-och-oper:och-oper/och-ports/och-port
Cisco-IOS-XR-pmengine-oper:performance-management/optics/optics-ports/ optics-port/optics-current/optics-second30/optics-second30-optics
Cisco-IOS-XR-pmengine-oper:performance-management-history/global/periodic/ optics-history/optics-port-histories/optics-port-history/optics-second30-history/ optics-second30-optics-histories/optics-second30-optics-history/ optics-second30-optics-time-line-instances/optics-second30-optics-time-line-instance[number=1]
Cisco-IOS-XR-invmgr-oper:inventory/entities/entity/attributes
Cisco-IOS-XR-controller-dfb-oper:dfb-oper/dfb-ports/dfb-port
Cisco-IOS-XR-envmon-oper:environmental-monitoring
Cisco-IOS-XR-envmon-oper:power-management
Cisco-IOS-XR-invmgr-diag-oper:diag/racks/rack
Cisco-IOS-XR-ifmgr-oper:interface-properties/data-nodes/data-node/system-view/interfaces/interface
Cisco-IOS-XR-infra-syslog-oper:syslog/messages/message
Cisco-IOS-XR-olc-oper:olc

To enable telemetry on a node, use the following commands:

```
RP/0/RP0/CPU0:ios#config
RP/0/RP0/CPU0:ios(config)#grpc
RP/0/RP0/CPU0:ios(config-grpc)#port 57400
RP/0/RP0/CPU0:ios(config-grpc)#commit
```

Update the subscribe request for your sensor path and run the gNMI command from the terminal. Ensure the device management IP is configured and the device can be reached from the terminal.

The following is a sample of the subscription request (gnmi_sub_sample.txt)

```
subscribe: <
  prefix: <
  >
  subscription: <
  path: <
  elem: <
  name: "Cisco-IOS-XR-controller-ots-oper:ots-oper/ots-ports/ots-port/ots-info"
  >
  >
  mode: SAMPLE
  sample_interval: 10000000000
```

```
>
mode: STREAM
#mode: ONCE
encoding: PROTO
>
```

Update the subscribe request for the sensor path and run the gNMI command from the terminal.

```
-bash-4.2$ /filepath/telemetry/gnmi/gnmi_cli_latest -a 198.51.100.122:57400 -insecure -insecure_username
cisco -insecure_password cisco123 -proto "$(cat gnmi_sub_sample.txt)" -qt s -dt p
```

To save the telemetry data to a file, use the following command:

```
-bash-4.2$ /filepath/telemetry/gnmi/gnmi_cli_latest -a 198.51.100.122:57400 -insecure -insecure_username
cisco -insecure_password cisco123 -proto "$(cat gnmi_sub_sample.txt)" -qt s -dt p > telemetry-data.txt
```

The following is a sample of the telemetry data that is fetched from the device:

```
update: <
  timestamp: 1658726311307000000
  prefix: <
    origin: "Cisco-IOS-XR-controller-ots-oper"
    elem: <
      name: "ots-oper"
    >
    elem: <
      name: "ots-ports"
    >
    elem: <
      name: "ots-port"
      key: <
        key: "name"
        value: "Ots0/0/0/0"
      >
    >
    elem: <
      name: "ots-info"
    >
  >
update: <
  path: <
    elem: <
      name: "transport-admin-state"
    >
  >
  val: <
    string_val: "ots-tas-ui-is"
  >
  >
update: <
  path: <
    elem: <
      name: "rx-pow-low-threshold"
    >
  >
  val: <
    int_val: -32768
  >
  >
.
.
snipped
.
.
>
```



```

update: <
  path: <
    elem: <
      name: "ots-tone-info"
    >
    elem: <
      name: "dectedected-oob"
    >
  >
  val: <
    uint_val: 0
  >
>
update: <
  path: <
    elem: <
      name: "ots-tone-info"
    >
    elem: <
      name: "state"
    >
  >
  val: <
    string_val: "conn-vrfcn-state-not-running"
  >
>
>

sync_response: true

```

- **memory-top-consumers command:** Use this command to check memory usage on the node.

```

RP/0/RP0/CPU0:OLT-C-R-SITE-1#show memory-top-consumers location 0/RP0/CPU0
Fri Jul 22 06:33:01.285 UTC

```

Execute 'show memory-snapshots process <> location <>' to check memory usage trend.

```

#####
Top memory consumers on 0/RP0/CPU0 (at 2022/Jul/22/06:27:22)
#####
  PID          Process    Total (MB)    Heap (MB)    Shared (MB)
  7070          emsd          319.3         78.18        221.5
  5694          yang_server   313.3         2.71         307.6
  7087          netconf      234.2         52.41        184.7
  5912          osa_driver    174.0         64.88        106.1
  2645          fpd_client    141.0         98.65         33.4
  3669          spp          114.7         6.04         107.9
  3996          nvgen_server  100.3         40.86         53.4
  9464          python3       100.1         -             40.6
  3678          packet        98.7         1.43         97.4
  4629          fib_mgr       96.0         -             88.8
RP/0/RP0/CPU0:OLT-C-R-SITE-1#

```

Related Documentation

Use this publication in conjunction with the following documentation:

- [Release Notes for Cisco NCS 1000 Series, IOS XR Release 7.7.1](#)
- [Hardware Installation Guide for Cisco NCS 1010 and Cisco NCS 1000 Passive Modules](#)
- [Regulatory Compliance and Safety Information - Cisco NCS 1010](#)

- [Cisco NCS 1010 System Setup and Software Installation Guide, IOS XR Release 7.7.x](#)
- [Cisco NCS 1010 Datapath Configuration Guide, IOS XR Release 7.7.x](#)
- [Cisco NCS 1010 Optical Applications Configuration Guide, IOS XR Release 7.7.x](#)
- [Command Reference for Cisco NCS 1010](#)
- [Data Models Configuration Guide for Cisco NCS 1010](#)
- [Troubleshooting Guide for Cisco NCS 1010, IOS XR Release 7.7.1](#)

