



Cisco ONS 15454 Troubleshooting Guide

Product and Documentation Release 8.0

Last Updated: September 2010

Corporate Headquarters

Cisco Systems, Inc.
170 West Tasman Drive
San Jose, CA 95134-1706
USA
<http://www.cisco.com>
Tel: 408 526-4000
800 553-NETS (6387)
Fax: 408 526-4100

Text Part Number: 78-17699-01



THE SPECIFICATIONS AND INFORMATION REGARDING THE PRODUCTS IN THIS MANUAL ARE SUBJECT TO CHANGE WITHOUT NOTICE. ALL STATEMENTS, INFORMATION, AND RECOMMENDATIONS IN THIS MANUAL ARE BELIEVED TO BE ACCURATE BUT ARE PRESENTED WITHOUT WARRANTY OF ANY KIND, EXPRESS OR IMPLIED. USERS MUST TAKE FULL RESPONSIBILITY FOR THEIR APPLICATION OF ANY PRODUCTS.

THE SOFTWARE LICENSE AND LIMITED WARRANTY FOR THE ACCOMPANYING PRODUCT ARE SET FORTH IN THE INFORMATION PACKET THAT SHIPPED WITH THE PRODUCT AND ARE INCORPORATED HEREIN BY THIS REFERENCE. IF YOU ARE UNABLE TO LOCATE THE SOFTWARE LICENSE OR LIMITED WARRANTY, CONTACT YOUR CISCO REPRESENTATIVE FOR A COPY.

The following information is for FCC compliance of Class A devices: This equipment has been tested and found to comply with the limits for a Class A digital device, pursuant to part 15 of the FCC rules. These limits are designed to provide reasonable protection against harmful interference when the equipment is operated in a commercial environment. This equipment generates, uses, and can radiate radio-frequency energy and, if not installed and used in accordance with the instruction manual, may cause harmful interference to radio communications. Operation of this equipment in a residential area is likely to cause harmful interference, in which case users will be required to correct the interference at their own expense.

The following information is for FCC compliance of Class B devices: The equipment described in this manual generates and may radiate radio-frequency energy. If it is not installed in accordance with Cisco's installation instructions, it may cause interference with radio and television reception. This equipment has been tested and found to comply with the limits for a Class B digital device in accordance with the specifications in part 15 of the FCC rules. These specifications are designed to provide reasonable protection against such interference in a residential installation. However, there is no guarantee that interference will not occur in a particular installation.

Modifying the equipment without Cisco's written authorization may result in the equipment no longer complying with FCC requirements for Class A or Class B digital devices. In that event, your right to use the equipment may be limited by FCC regulations, and you may be required to correct any interference to radio or television communications at your own expense.

You can determine whether your equipment is causing interference by turning it off. If the interference stops, it was probably caused by the Cisco equipment or one of its peripheral devices. If the equipment causes interference to radio or television reception, try to correct the interference by using one or more of the following measures:

- Turn the television or radio antenna until the interference stops.
- Move the equipment to one side or the other of the television or radio.
- Move the equipment farther away from the television or radio.
- Plug the equipment into an outlet that is on a different circuit from the television or radio. (That is, make certain the equipment and the television or radio are on circuits controlled by different circuit breakers or fuses.)

Modifications to this product not authorized by Cisco Systems, Inc. could void the FCC approval and negate your authority to operate the product.

The Cisco implementation of TCP header compression is an adaptation of a program developed by the University of California, Berkeley (UCB) as part of UCB's public domain version of the UNIX operating system. All rights reserved. Copyright © 1981, Regents of the University of California.

NOTWITHSTANDING ANY OTHER WARRANTY HEREIN, ALL DOCUMENT FILES AND SOFTWARE OF THESE SUPPLIERS ARE PROVIDED "AS IS" WITH ALL FAULTS. CISCO AND THE ABOVE-NAMED SUPPLIERS DISCLAIM ALL WARRANTIES, EXPRESSED OR IMPLIED, INCLUDING, WITHOUT LIMITATION, THOSE OF MERCHANTABILITY, FITNESS FOR A PARTICULAR PURPOSE AND NONINFRINGEMENT OR ARISING FROM A COURSE OF DEALING, USAGE, OR TRADE PRACTICE.

IN NO EVENT SHALL CISCO OR ITS SUPPLIERS BE LIABLE FOR ANY INDIRECT, SPECIAL, CONSEQUENTIAL, OR INCIDENTAL DAMAGES, INCLUDING, WITHOUT LIMITATION, LOST PROFITS OR LOSS OR DAMAGE TO DATA ARISING OUT OF THE USE OR INABILITY TO USE THIS MANUAL, EVEN IF CISCO OR ITS SUPPLIERS HAVE BEEN ADVISED OF THE POSSIBILITY OF SUCH DAMAGES.

Cisco and the Cisco Logo are trademarks of Cisco Systems, Inc. and/or its affiliates in the U.S. and other countries. A listing of Cisco's trademarks can be found at www.cisco.com/go/trademarks. Third party trademarks mentioned are the property of their respective owners. The use of the word partner does not imply a partnership relationship between Cisco and any other company. (1005R)

Cisco ONS 15454 Troubleshooting Guide, Release 8.0
© 2006–2011 Cisco Systems Inc. All rights reserved.



About this Guide xxxv

Revision History xxxv

Document Objectives xxxvi

Audience xxxvii

Related Documentation xxxvii

Document Conventions xxxvii

Obtaining Optical Networking Information xliv

Where to Find Safety and Warning Information xliv

Cisco Optical Networking Product Documentation CD-ROM xliv

Obtaining Documentation and Submitting a Service Request xliv

CHAPTER 1

General Troubleshooting 1-1

1.1 Troubleshooting Circuit Paths with Loopbacks 1-2

1.1.1 Facility Loopbacks 1-2

1.1.1.1 General Behavior 1-3

1.1.1.2 ONS 15454 Card Behavior 1-4

1.1.2 Terminal Loopbacks 1-5

1.1.2.1 General Behavior 1-5

1.1.2.2 ONS 15454 Card Behavior 1-6

1.1.3 Hairpin Circuits 1-8

1.1.4 Cross-Connect Loopbacks 1-8

1.2 Troubleshooting Electrical Circuit Paths With Loopbacks 1-9

1.2.1 Perform a Facility Loopback on a Source Electrical Port (West to East) 1-10

Create the Facility Loopback on the Source DS-1, DS-3, DS3N-12, DS3i-N-12, or EC1 Port 1-10

Test and Clear the DS-3, DS3N-12, DS3i-N-12, or EC1 Port Facility Loopback Circuit 1-11

Create the Facility Loopback on the Source DS3E or DS3XM Port 1-11

Test and Clear the DS3E or DS3XM Port Facility Loopback Circuit 1-12

Test the Electrical Cabling 1-13

Test the Electrical Card 1-13

Test the EIA 1-14

1.2.2 Perform a Hairpin Test on a Source-Node Electrical Port (West to East) 1-15

Create the Hairpin Circuit on the Source-Node Electrical Port 1-15

Test and Delete the Electrical Port Hairpin Circuit 1-16

Test the Standby Cross-Connect Card 1-16

Retest the Original Cross-Connect Card	1-17
1.2.3 Perform an XC Loopback on a Destination-Node OC-N STS (West to East) Carrying an Electrical Signal	1-18
Create the XC Loopback on a Destination-Node OCN STS	1-19
Test and Clear the XC Loopback Circuit	1-20
Test the Standby Cross-Connect Card	1-20
Retest the Original Cross-Connect Card	1-21
1.2.4 Perform a Terminal Loopback on a Destination Electrical Port (West to East)	1-22
Create the Terminal Loopback on a Destination DS-3, DS3N-12, DS3i-N-12, or EC1 Port	1-23
Test and Clear the DS-3, DS3N-12, DS3i-N-12, or EC1 Destination Port Terminal Loopback Circuit	1-24
Create the Terminal Loopback on a Destination DS-3E or DS3XM Port	1-25
Test and Clear the DS-3E or DS3XM Destination Port Terminal Loopback Circuit	1-26
Test the Destination Electrical Card	1-27
1.2.5 Perform a Facility Loopback on a Destination-Node Electrical Port (East to West)	1-27
Create the Facility Loopback on the Destination DS-1, DS-3, DS3N-12, DS3i-N-12, or EC-1 Port	1-28
Test and Clear the DS-3, DS3N-12, DS3i-N-12, or EC-1 Port Facility Loopback Circuit	1-29
Create the Facility Loopback on the Source DS3E or DS3XM Port	1-29
Test and Clear the DS3E or DS3XM Port Facility Loopback Circuit	1-30
Test the Electrical Cabling	1-30
Test the Electrical Card	1-31
Test the EIA	1-32
1.2.6 Perform a Hairpin Test on a Destination-Node Electrical Port (East to West)	1-33
Create the Hairpin Circuit on the Destination-Node Port	1-33
Test and Delete the Electrical Hairpin Circuit	1-34
Test the Standby Cross-Connect Card	1-34
Retest the Original Cross-Connect Card	1-35
1.2.7 Perform an XC Loopback on a Source-Node OC-N STS (East to West) Carrying an Electrical Circuit	1-36
Create the XC Loopback on the Source OC-N Port Carrying an Electrical Circuit	1-37
Test and Clear the XC Loopback Circuit	1-38
Test the Standby Cross-Connect Card	1-38
Retest the Original Cross-Connect Card	1-39
1.2.8 Perform a Terminal Loopback on a Source-Node Electrical Port (East to West)	1-40
Create the Terminal Loopback on a Source DS-1, DS-3, DS3N-12, DS3i-N-12, or EC1 Port	1-41
Test and Clear the DS-3, DS3N-12, DS3i-N-12, or EC1 Port Terminal Loopback	1-42
Create the Terminal Loopback on a Source DS3E or DS3XM Port	1-43
Test and Clear the DS3E or DS3XM Port Terminal Loopback Circuit	1-44
Test the Source Electrical Card	1-45

1.3	Troubleshooting DS3XM-6 or DS3XM-12 Card Electrical Paths With FEAC Loopbacks	1-45
1.3.1	FEAC Send Code	1-46
1.3.2	DS-3E and DS3i-N-12 Inhibit Loopback	1-47
1.3.3	DS3XM-6 and DS3XM-12 Inhibit FEAC Loopback	1-47
1.3.4	FEAC Alarms	1-47
1.4	Troubleshooting Optical Circuit Paths With Loopbacks	1-47
1.4.1	Perform a Facility Loopback on a Source-Node Optical Port	1-48
	Create the Facility Loopback on the Source Optical Port	1-48
	Test and Clear the Facility Loopback Circuit	1-49
	Test the OC-N Card	1-49
1.4.2	Perform a Terminal Loopback on a Source-Node Optical Port	1-50
	Create the Terminal Loopback on a Source-Node Optical Port	1-50
	Test and Clear the Terminal Loopback Circuit	1-52
	Test the Optical Card	1-52
1.4.3	Perform an XC Loopback on the Source Optical Port	1-53
	Create the XC Loopback on the Source-Node Optical Port	1-53
	Test and Clear the XC Loopback Circuit	1-54
	Test the Standby Cross-Connect Card	1-55
	Retest the Original Cross-Connect Card	1-56
1.4.4	Perform a Facility Loopback on an Intermediate-Node Optical Port	1-57
	Create a Facility Loopback on an Intermediate-Node Optical Port	1-57
	Test and Clear the Facility Loopback Circuit	1-58
	Test the Optical Card	1-59
1.4.5	Perform a Terminal Loopback on Intermediate-Node Optical Ports	1-59
	Create a Terminal Loopback on Intermediate-Node Optical Ports	1-60
	Test and Clear the Optical Terminal Loopback Circuit	1-61
	Test the Optical Card	1-62
1.4.6	Perform a Facility Loopback on a Destination-Node Optical Port	1-63
	Create the Facility Loopback on a Destination-Node Optical Port	1-63
	Test and Clear the Optical Facility Loopback Circuit	1-64
	Test the Optical Card	1-65
1.4.7	Perform a Terminal Loopback on a Destination-Node Optical Port	1-65
	Create the Terminal Loopback on a Destination-Node Optical Port	1-66
	Test and Clear the Optical Terminal Loopback Circuit	1-67
	Test the Optical Card	1-68
1.5	Troubleshooting Ethernet Circuit Paths With Loopbacks	1-68
1.5.1	Perform a Facility Loopback on a Source-Node Ethernet Port	1-69
	Create the Facility Loopback on the Source-Node Ethernet Port	1-70
	Test and Clear the Facility Loopback Circuit	1-70
	Test the Ethernet Card	1-71

1.5.2	Perform a Terminal Loopback on a Source-Node Ethernet Port	1-71
	Create the Terminal Loopback on a Source-Node Ethernet Port	1-72
	Test and Clear the Ethernet Terminal Loopback Circuit	1-73
	Test the Ethernet Card	1-74
1.5.3	Perform a Hairpin Test on a Source-Node Ethernet Port	1-75
	Create the Hairpin Circuit on the Source-Node Ethernet Port	1-75
	Test and Delete the Ethernet Port Hairpin Circuit	1-76
	Test the Standby Cross-Connect Card	1-76
	Retest the Original Cross-Connect Card	1-77
1.5.4	Create a Facility Loopback on an Intermediate-Node Ethernet Port	1-78
	Create a Facility Loopback on an Intermediate-Node Ethernet Port	1-79
	Test and Clear the Ethernet Facility Loopback Circuit	1-80
	Test the Ethernet Card	1-80
1.5.5	Create a Terminal Loopback on Intermediate-Node Ethernet Ports	1-81
	Create a Terminal Loopback on Intermediate-Node Ethernet Ports	1-82
	Test and Clear the Ethernet Terminal Loopback Circuit	1-83
	Test the Ethernet Card	1-83
1.5.6	Perform a Facility Loopback on a Destination-Node Ethernet Port	1-84
	Create the Facility Loopback on a Destination-Node Ethernet Port	1-85
	Test and Clear the Ethernet Facility Loopback Circuit	1-86
	Test the Ethernet Card	1-86
1.5.7	Perform a Terminal Loopback on a Destination-Node Ethernet Port	1-87
	Create the Terminal Loopback on a Destination-Node Ethernet Port	1-87
	Test and Clear the Ethernet Terminal Loopback Circuit	1-89
	Test the Ethernet Card	1-89
1.5.8	Perform a Hairpin Test on a Destination-Node Ethernet Port	1-90
	Create the Hairpin Circuit on the Destination-Node Port	1-91
	Test and Delete the Ethernet Hairpin Circuit	1-91
	Test the Standby Cross-Connect Card	1-92
	Retest the Original Cross-Connect Card	1-93
1.6	Troubleshooting FC_MR Circuit Paths With Loopbacks	1-94
1.6.1	Perform a Facility Loopback on a Source-Node FC_MR Port	1-94
	Create the Facility Loopback on the Source-Node FC_MR Port	1-95
	Test and Clear the FC_MR Facility Loopback Circuit	1-95
	Test the FC_MR Card	1-96
1.6.2	Perform a Terminal Loopback on a Source-Node FC_MR Port	1-96
	Create the Terminal Loopback on a Source-Node FC_MR Port	1-97
	Test and Clear the FC_MR Port Terminal Loopback Circuit	1-98
	Test the FC_MR Card	1-98
1.6.3	Create a Facility Loopback on an Intermediate-Node FC_MR Port	1-99

Create a Facility Loopback on an Intermediate-Node FC_MR Port	1-99
Test and Clear the FC_MR Port Facility Loopback Circuit	1-100
Test the FC_MR Card	1-100
1.6.4 Create a Terminal Loopback on Intermediate-Node FC_MR Ports	1-101
Create a Terminal Loopback on Intermediate-Node FC_MR Ports	1-101
Test and Clear the FC_MR Terminal Loopback Circuit	1-102
Test the FC_MR Card	1-102
1.6.5 Perform a Facility Loopback on a Destination-Node FC_MR Port	1-103
Create the Facility Loopback on a Destination-Node FC_MR Port	1-103
Test and Clear the FC_MR Facility Loopback Circuit	1-104
Test the FC_MR Card	1-104
1.6.6 Perform a Terminal Loopback on a Destination-Node FC_MR Port	1-105
Create the Terminal Loopback on a Destination-Node FC_MR Port	1-105
Test and Clear the FC_MR Terminal Loopback Circuit	1-106
Test the FC_MR Card	1-107
1.7 Using CTC Diagnostics	1-107
1.7.1 Card LED Lamp Tests	1-108
Verify General Card LED Operation	1-108
Verify G-Series Ethernet or FC_MR Card Port-Level LED Operation	1-109
Verify E-Series and ML-Series Ethernet Card Port-Level LED Operation	1-109
1.7.2 Retrieve Diagnostics File Button	1-110
Off-Load the Diagnostics File	1-110
1.7.3 Bidirectional Diagnostic Circuit	1-110
Create a Bidirectional Diagnostic Circuit	1-112
1.7.4 Data Communications Network Tool	1-113
1.8 Restoring the Database and Default Settings	1-114
1.8.1 Restore the Node Database	1-114
1.9 PC Connectivity Troubleshooting	1-115
1.9.1 PC System Minimum Requirements	1-115
1.9.2 Sun System Minimum Requirements	1-115
1.9.3 Supported Platforms, Browsers, and JREs	1-115
1.9.4 Unsupported Platforms and Browsers	1-116
1.9.5 Unable to Verify the IP Configuration of Your PC	1-116
Verify the IP Configuration of Your PC	1-116
1.9.6 Browser Login Does Not Launch Java	1-117
Reconfigure the PC Operating System Java Plug-in Control Panel	1-117
Reconfigure the Browser	1-118
1.9.7 Unable to Verify the NIC Connection on Your PC	1-118
1.9.8 Verify PC Connection to the ONS 15454 (ping)	1-119

- Ping the ONS 15454 1-119
- 1.9.9 The IP Address of the Node is Unknown 1-120
 - Retrieve Unknown Node IP Address 1-120
- 1.10 CTC Operation Troubleshooting 1-120
 - 1.10.1 CTC Colors Do Not Appear Correctly on a UNIX Workstation 1-121
 - Limit Netscape Colors 1-121
 - 1.10.2 Unable to Launch CTC Help After Removing Netscape 1-121
 - Reset Internet Explorer as the Default Browser for CTC 1-121
 - 1.10.3 Unable to Change Node View to Network View 1-122
 - Reset the CTC_HEAP Environment Variable for Windows 1-122
 - Reset the CTC_HEAP Environment Variable for Solaris 1-122
 - 1.10.4 Browser Stalls When Downloading CTC JAR Files From TCC2/TCC2P Card 1-123
 - Disable the VirusScan Download Scan 1-123
 - 1.10.5 CTC Does Not Launch 1-123
 - Redirect the Netscape Cache to a Valid Directory 1-124
 - 1.10.6 Slow CTC Operation or Login Problems 1-124
 - Delete the CTC Cache File Automatically 1-124
 - Delete the CTC Cache File Manually 1-125
 - 1.10.7 Node Icon is Gray on CTC Network View 1-126
 - 1.10.8 CTC Cannot Launch Due to Applet Security Restrictions 1-126
 - Manually Edit the java.policy File 1-126
 - 1.10.9 Java Runtime Environment Incompatible 1-127
 - Launch CTC to Correct the Core Version Build 1-128
 - 1.10.10 Different CTC Releases Do Not Recognize Each Other 1-128
 - Launch CTC to Correct the Core Version Build 1-128
 - 1.10.11 Username or Password Do Not Match 1-129
 - Verify Correct Username and Password 1-129
 - 1.10.12 No IP Connectivity Exists Between Nodes 1-129
 - 1.10.13 DCC Connection Lost 1-130
 - 1.10.14 "Path in Use" Error When Creating a Circuit 1-130
 - 1.10.15 Calculate and Design IP Subnets 1-130
 - 1.10.16 Ethernet Connections 1-131
 - Verify Ethernet Connections 1-131
 - 1.10.17 VLAN Cannot Connect to Network Device from Untag Port 1-132
 - Change VLAN Port Tagged and Untag Settings 1-133
- 1.11 Circuits and Timing 1-134
 - 1.11.1 OC-N Circuit Transitions to Partial State 1-134
 - View the State of OC-N Circuit Nodes 1-134
 - 1.11.2 AIS-V on DS3XM-6 or DS3XM-12 Unused VT Circuits 1-135
 - Clear AIS-V on DS3XM-6 or DS3XM-12 Unused VT Circuits 1-135

1.11.3	Circuit Creation Error with VT1.5 Circuit	1-136
1.11.4	Unable to Create Circuit From DS-3 Card to DS3XM-6 or DS3XM-12 Card	1-136
1.11.5	DS-3 Card Does Not Report AIS-P From External Equipment	1-136
1.11.6	OC-3 and DCC Limitations	1-137
1.11.7	ONS 15454 Switches Timing Reference	1-137
1.11.8	Holdover Synchronization Alarm	1-137
1.11.9	Free-Running Synchronization Mode	1-138
1.11.10	Daisy-Chained BITS Not Functioning	1-138
1.11.11	Blinking STAT LED after Installing a Card	1-138
1.12	Fiber and Cabling	1-138
1.12.1	Bit Errors Appear for a Traffic Card	1-139
1.12.2	Faulty Fiber-Optic Connections	1-139
	Verify Fiber-Optic Connections	1-139
1.12.2.1	Crimp Replacement LAN Cables	1-141
1.12.2.2	Replace Faulty GBIC, SFP, or XFP Connectors	1-143
	Remove GBIC, SFP, or XFP Connectors	1-144
	Install a GBIC or SFP/XFP Device	1-144
1.12.3	OC-N Card Transmit and Receive Levels	1-145
1.13	Power Supply Problems	1-147
	Isolate the Cause of Power Supply Problems	1-148
1.13.1	Power Consumption for Node and Cards	1-149

CHAPTER 2**Alarm Troubleshooting 2-1**

2.1	Alarm Indexes by Default Severity	2-1
2.1.1	Critical Alarms (CR)	2-2
2.1.2	Major Alarms (MJ)	2-3
2.1.3	Minor Alarms (MN)	2-4
2.1.4	NA Conditions	2-6
2.1.5	NR Conditions	2-10
2.2	Alarms and Conditions Listed By Alphabetical Entry	2-11
2.3	Alarm Logical Objects	2-20
2.4	Alarm List by Logical Object Type	2-23
2.5	Trouble Notifications	2-32
2.5.1	Alarm Characteristics	2-32
2.5.2	Condition Characteristics	2-32
2.5.3	Severities	2-33
2.5.4	Alarm Hierarchy	2-33
2.5.5	Service Effect	2-35
2.5.6	States	2-35

2.6	Safety Summary	2-36
2.7	Alarm Procedures	2-36
2.7.1	AIS	2-37
	Clear the AIS Condition	2-37
2.7.2	AIS-L	2-38
	Clear the AIS-L Condition	2-38
2.7.3	AIS-P	2-38
	Clear the AIS-P Condition	2-38
2.7.4	AIS-V	2-38
	Clear the AIS-V Condition	2-39
2.7.5	ALS	2-39
2.7.6	AMPLI-INIT	2-39
2.7.7	APC-CORR-SKIPPED	2-39
2.7.8	APC-DISABLED	2-39
2.7.9	APC-END	2-39
2.7.10	APC-OUT-OF-RANGE	2-39
2.7.11	APC-WRONG-GAIN	2-40
2.7.12	APSB	2-40
2.7.13	APSCDFLTk	2-40
	Clear the APSCDFLTk Alarm	2-40
2.7.14	APSC-IMP	2-41
	Clear the APSC-IMP Alarm	2-42
2.7.15	APSCINCON	2-42
	Clear the APSCINCON Alarm	2-42
2.7.16	APSCM	2-43
	Clear the APSCM Alarm	2-43
2.7.17	APSCNMIS	2-44
	Clear the APSCNMIS Alarm	2-44
2.7.18	APSIMP	2-44
	Clear the APSIMP Alarm	2-45
2.7.19	APS-INV-PRIM	2-45
2.7.20	APSMM	2-45
	Clear the APSMM Alarm	2-45
2.7.21	APS-PRIM-FAC	2-46
	Clear the APS-PRIM-FAC Condition	2-46
2.7.22	APS-PRIM-SEC-MISM	2-46
	Clear the APS-PRIM-SEC-MISM Alarm	2-47
2.7.23	AS-CMD	2-47
	Clear the AS-CMD Condition	2-47
2.7.24	AS-MT	2-48

Clear the AS-MT Condition	2-48
2.7.25 AS-MT-OOG	2-48
2.7.26 AUD-LOG-LOSS	2-49
Clear the AUD-LOG-LOSS Condition	2-49
2.7.27 AUD-LOG-LOW	2-49
2.7.28 AUTOLSROFF	2-50
Clear the AUTOLSROFF Alarm	2-50
2.7.29 AUTONEG-RFI	2-51
Clear the AUTONEG-RFI Alarm	2-51
2.7.30 AUTORESET	2-52
Clear the AUTORESET Alarm	2-52
2.7.31 AUTOSW-AIS	2-52
Clear the AUTOSW-AIS Condition	2-52
2.7.32 AUTOSW-LOP (STSMON)	2-53
Clear the AUTOSW-LOP (STSMON) Condition	2-53
2.7.33 AUTOSW-LOP (VT-MON)	2-53
Clear the AUTOSW-LOP (VT-MON) Condition	2-53
2.7.34 AUTOSW-PDI	2-54
Clear the AUTOSW-PDI Condition	2-54
2.7.35 AUTOSW-SDBER	2-54
Clear the AUTOSW-SDBER Condition	2-54
2.7.36 AUTOSW-SFBER	2-54
Clear the AUTOSW-SFBER Condition	2-55
2.7.37 AUTOSW-UNEQ (STSMON)	2-55
Clear the AUTOSW-UNEQ (STSMON) Condition	2-55
2.7.38 AUTOSW-UNEQ (VT-MON)	2-55
Clear the AUTOSW-UNEQ (VT-MON) Condition	2-56
2.7.39 AWG-DEG	2-56
2.7.40 AWG-FAIL	2-56
2.7.41 AWG-OVERTEMP	2-56
2.7.42 AWG-WARM-UP	2-56
2.7.43 BAT-FAIL	2-56
Clear the BAT-FAIL Alarm	2-56
2.7.44 BKUPMEMP	2-57
Clear the BKUPMEMP Alarm	2-57
2.7.45 BLSROSYNC	2-58
2.7.46 BLSR-SW-VER-MISM	2-58
Clear the BLSR-SW-VER-MISM Alarm	2-58
2.7.47 BPV	2-58
Clear the BPV Alarm	2-59

2.7.48	CARLOSS (CE1000, CE100T)	2-59	
	Clear the CARLOSS (CE1000, CE100T) Alarm		2-59
2.7.49	CARLOSS (E1000F, E100T)	2-59	
	Clear the CARLOSS (E1000F, E100T) Alarm		2-60
2.7.50	CARLOSS (EQPT)	2-61	
	Clear the CARLOSS (EQPT) Alarm		2-62
2.7.51	CARLOSS (FC)	2-63	
2.7.52	CARLOSS (G1000)	2-63	
	Clear the CARLOSS (G1000) Alarm		2-63
2.7.53	CARLOSS (GE)	2-65	
2.7.54	CARLOSS (ISC)	2-65	
2.7.55	CARLOSS (ML1000, ML100T, MLFX)	2-66	
	Clear the CARLOSS (ML1000, ML100T, MLFX) Alarm		2-66
2.7.56	CARLOSS (TRUNK)	2-67	
2.7.57	CASETMP-DEG	2-67	
2.7.58	CLDRESTART	2-67	
	Clear the CLDRESTART Condition		2-67
2.7.59	COMIOXC	2-67	
	Clear the COMIOXC Alarm		2-67
2.7.60	COMM-FAIL	2-68	
	Clear the COMM-FAIL Alarm		2-68
2.7.61	CONTBUS-A-18	2-68	
	Clear the CONTBUS-A-18 Alarm		2-68
2.7.62	CONTBUS-B-18	2-69	
	Clear the CONTBUS-B-18 Alarm		2-69
2.7.63	CONTBUS-DISABLED	2-69	
	Clear the CONTBUS-DISABLED Alarm		2-70
2.7.64	CONTBUS-IO-A	2-70	
	Clear the CONTBUS-IO-A Alarm		2-70
2.7.65	CONTBUS-IO-B	2-71	
	Clear the CONTBUS-IO-B Alarm		2-71
2.7.66	CPP-INCAPABLE	2-72	
	Clear the CPP-INCAPABLE Alarm		2-72
2.7.67	CTNEQPT-MISMATCH	2-73	
	Clear the CTNEQPT-MISMATCH Condition		2-73
2.7.68	CTNEQPT-PBPROT	2-73	
	Clear the CTNEQPT-PBPROT Alarm		2-74
2.7.69	CTNEQPT-PBWORK	2-75	
	Clear the CTNEQPT-PBWORK Alarm		2-75
2.7.70	DATA-CRC	2-76	

Clear the DATA-CRC Alarm	2-76
2.7.71 DATAFLT	2-77
Clear the DATAFLT Alarm	2-77
2.7.72 DBOSYNC	2-77
Clear the DBOSYNC Alarm	2-77
2.7.73 DCU-LOSS-FAIL	2-78
2.7.74 DISCONNECTED	2-78
Clear the DISCONNECTED Alarm	2-78
2.7.75 DS3-MISM	2-78
Clear the DS3-MISM Condition	2-78
2.7.76 DSP-COMM-FAIL	2-79
2.7.77 DSP-FAIL	2-79
2.7.78 DUP-IPADDR	2-79
Clear the DUP-IPADDR Alarm	2-79
2.7.79 DUP-NODENAME	2-80
Clear the DUP-NODENAME Alarm	2-80
2.7.80 DUP-SHELF-ID	2-80
2.7.81 EHIBATVG	2-80
Clear the EHIBATVG Alarm	2-80
2.7.82 ELWBATVG	2-81
Clear the ELWBATVG Alarm	2-81
2.7.83 ENCAP-MISMATCH-P	2-81
Clear the ENCAP-MISMATCH-P Alarm	2-82
2.7.84 EOC	2-83
Clear the EOC Alarm	2-83
2.7.85 EOC-L	2-85
Clear the EOC-L Alarm	2-86
2.7.86 EQPT	2-86
Clear the EQPT Alarm	2-86
2.7.87 EQPT-DIAG	2-87
Clear the EQPT-DIAG Alarm	2-87
2.7.88 EQPT-MISS	2-87
Clear the EQPT-MISS Alarm	2-87
2.7.89 ERFI-P-CONN	2-88
Clear the ERFI-P-CONN Condition	2-88
2.7.90 ERFI-P-PAYLD	2-88
Clear the ERFI-P-PAYLD Condition	2-88
2.7.91 ERFI-P-SRVR	2-88
Clear the ERFI-P-SRVR Condition	2-89
2.7.92 ERROR-CONFIG	2-89

	Clear the ERROR-CONFIG Alarm	2-89
2.7.93	ETH-LINKLOSS	2-90
	Clear the ETH-LINKLOSS Condition	2-90
2.7.94	E-W-MISMATCH	2-90
	Clear the E-W-MISMATCH Alarm with a Physical Switch	2-91
	Clear the E-W-MISMATCH Alarm in CTC	2-92
2.7.95	EXCCOL	2-92
	Clear the EXCCOL Alarm	2-93
2.7.96	EXERCISE-RING-FAIL	2-93
	Clear the EXERCISE-RING-FAIL Condition	2-93
2.7.97	EXERCISE-SPAN-FAIL	2-93
	Clear the EXERCISE-SPAN-FAIL Condition	2-94
2.7.98	EXT	2-94
	Clear the EXT Alarm	2-94
2.7.99	EXTRA-TRAF-PREEMPT	2-94
	Clear the EXTRA-TRAF-PREEMPT Alarm	2-95
2.7.100	FAILTOSW	2-95
	Clear the FAILTOSW Condition	2-95
2.7.101	FAILTOSW-PATH	2-96
	Clear the FAILTOSW-PATH Condition in a UPSR Configuration	2-96
2.7.102	FAILTOSWR	2-96
	Clear the FAILTOSWR Condition in a BLSR Configuration	2-97
2.7.103	FAILTOSWS	2-98
	Clear the FAILTOSWS Condition	2-98
2.7.104	FAN	2-100
	Clear the FAN Alarm	2-100
2.7.105	FAPS	2-100
	Clear the FAPS Alarm	2-101
2.7.106	FAPS-CONFIG-MISMATCH	2-101
2.7.107	FC-DE-NES	2-101
	Clear the FC-DE-NES Alarm	2-101
2.7.108	FC-NO-CREDITS	2-101
	Clear the FC-NO-CREDITS Alarm	2-102
2.7.109	FDI	2-103
2.7.110	FE-AIS	2-103
	Clear the FE-AIS Condition	2-103
2.7.111	FEC-MISM	2-103
2.7.112	FE-DS1-MULTLOS	2-103
	Clear the FE-DS1-MULTLOS Condition	2-104
2.7.113	FE-DS1-NSA	2-104

Clear the FE-DS1-NSA Condition	2-104
2.7.114 FE-DS1-SA	2-104
Clear the FE-DS1-SA Condition	2-105
2.7.115 FE-DS1-SNGLLOS	2-105
Clear the FE-DS1-SNGLLOS Condition	2-105
2.7.116 FE-DS3-NSA	2-105
Clear the FE-DS3-NSA Condition	2-106
2.7.117 FE-DS3-SA	2-106
Clear the FE-DS3-SA Condition	2-106
2.7.118 FE-EQPT-NSA	2-106
Clear the FE-EQPT-NSA Condition	2-107
2.7.119 FE-FRCDWKSWBK-SPAN	2-107
Clear the FE-FRCDWKSWBK-SPAN Condition	2-107
2.7.120 FE-FRCDWKSWPR-RING	2-107
Clear the FE-FRCDWKSWPR-RING Condition	2-108
2.7.121 FE-FRCDWKSWPR-SPAN	2-108
Clear the FE-FRCDWKSWPR-SPAN Condition	2-108
2.7.122 FE-IDLE	2-108
Clear the FE-IDLE Condition	2-109
2.7.123 FE-LOCKOUTOFPR-SPAN	2-109
Clear the FE-LOCKOUTOFPR-SPAN Condition	2-109
2.7.124 FE-LOF	2-109
Clear the FE-LOF Condition	2-110
2.7.125 FE-LOS	2-110
Clear the FE-LOS Condition	2-110
2.7.126 FE-MANWKSWBK-SPAN	2-110
Clear the FE-MANWKSWBK-SPAN Condition	2-111
2.7.127 FE-MANWKSWPR-RING	2-111
Clear the FE-MANWKSWPR-RING Condition	2-111
2.7.128 FE-MANWKSWPR-SPAN	2-111
Clear the FE-MANWKSWPR-SPAN Condition	2-112
2.7.129 FEPRLF	2-112
Clear the FEPRLF Alarm on a Four-Fiber BLSR	2-112
2.7.130 FIBERTEMP-DEG	2-112
2.7.131 FORCED-REQ	2-112
Clear the FORCED-REQ Condition	2-113
2.7.132 FORCED-REQ-RING	2-113
Clear the FORCED-REQ-RING Condition	2-113
2.7.133 FORCED-REQ-SPAN	2-114
Clear the FORCED-REQ-SPAN Condition	2-114

2.7.134	FP-LINK-LOSS	2-114	
	Clear the FP-LINK-LOSS Condition		2-114
2.7.135	FRCDSWTOINT	2-114	
2.7.136	FRCDSWTOPRI	2-115	
2.7.137	FRCDSWTOSEC	2-115	
2.7.138	FRCDSWTOTHIRD	2-115	
2.7.139	FRNGSYNC	2-115	
	Clear the FRNGSYNC Condition		2-116
2.7.140	FSTSYNC	2-116	
2.7.141	FTA-MISMATCH	2-116	
2.7.142	FULLPASSTHR-BI	2-116	
	Clear the FULLPASSTHR-BI Condition		2-117
2.7.143	GAIN-HDEG	2-117	
2.7.144	GAIN-HFAIL	2-117	
2.7.145	GAIN-LDEG	2-117	
2.7.146	GAIN-LFAIL	2-117	
2.7.147	GCC-EOC	2-117	
2.7.148	GE-OOSYNC	2-117	
2.7.149	GFP-CSF	2-117	
	Clear the GFP-CSF Alarm		2-118
2.7.150	GFP-DE-MISMATCH	2-118	
	Clear the GFP-DE-MISMATCH Alarm		2-118
2.7.151	GFP-EX-MISMATCH	2-119	
	Clear the GFP-EX-MISMATCH Alarm		2-119
2.7.152	GFP-LFD	2-119	
	Clear the GFP-LFD Alarm		2-120
2.7.153	GFP-NO-BUFFERS	2-120	
	Clear the GFP-NO-BUFFERS Alarm		2-120
2.7.154	GFP-UP-MISMATCH	2-121	
	Clear the GFP-UP-MISMATCH Alarm		2-121
2.7.155	HELLO	2-121	
	Clear the HELLO Alarm		2-122
2.7.156	HIBATVG	2-122	
	Clear the HIBATVG Alarm		2-122
2.7.157	HI-CCVOLT	2-122	
	Clear the HI-CCVOLT Condition		2-122
2.7.158	HI-LASERBIAS	2-123	
	Clear the HI-LASERBIAS Alarm		2-123
2.7.159	HI-LASERTEMP	2-123	
	Clear the HI-LASERTEMP Alarm		2-124

- 2.7.160 HI-RXPOWER 2-124
 - Clear the HI-RXPOWER Alarm 2-125
- 2.7.161 HITEMP 2-125
 - Clear the HITEMP Alarm 2-125
- 2.7.162 HI-TXPOWER 2-126
 - Clear the HI-TXPOWER Alarm 2-126
- 2.7.163 HLDVRSYNC 2-127
 - Clear the HLDVRSYNC Condition 2-127
- 2.7.164 I-HITEMP 2-128
 - Clear the I-HITEMP Alarm 2-128
- 2.7.165 ILK-FAIL 2-128
- 2.7.166 IMPROPRMVL 2-128
 - Clear the IMPROPRMVL Alarm 2-129
- 2.7.167 INCOMPATIBLE-SEND-PDIP 2-130
 - Clear the INCOMPATIBLE-SEND-PDIP Alarm 2-130
- 2.7.168 INCOMPATIBLE-SW 2-130
 - Clear the INCOMPATIBLE-SW Alarm 2-130
- 2.7.169 INC-ISD 2-130
- 2.7.170 INHSWPR 2-131
 - Clear the INHSWPR Condition 2-131
- 2.7.171 INHSHWKG 2-131
 - Clear the INHSHWKG Condition 2-131
- 2.7.172 INTRUSION-PSWD 2-132
 - Clear the INTRUSION-PSWD Condition 2-132
- 2.7.173 INVMACADR 2-132
 - Clear the INVMACADR Alarm 2-133
- 2.7.174 IOSCFGCOPY 2-134
- 2.7.175 ISIS-ADJ-FAIL 2-134
 - Clear the ISIS-ADJ-FAIL Alarm 2-135
- 2.7.176 KB-PASSTHR 2-136
 - Clear the KB-PASSTHR Condition 2-136
- 2.7.177 KBYTE-APS-CHAN-FAIL 2-136
 - Clear the KBYTE-APS-CHAN-FAIL Alarm 2-136
- 2.7.178 LAN-POL-REV 2-137
 - Clear the LAN-POL-REV Condition 2-137
- 2.7.179 LASER-APR 2-137
- 2.7.180 LASERBIAS-DEG 2-137
- 2.7.181 LASERBIAS-FAIL 2-138
- 2.7.182 LASEREOL 2-138
 - Clear the LASEREOL Alarm 2-138

2.7.183	LASERTEMP-DEG	2-138
2.7.184	LCAS-CRC	2-138
	Clear the LCAS-CRC Condition	2-139
2.7.185	LCAS-RX-DNU	2-139
	Clear the LCAS-RX-DNU Condition	2-140
2.7.186	LCAS-RX-FAIL	2-140
	Clear the LCAS-RX-FAIL Condition	2-140
2.7.187	LCAS-RX-GRP-ERR	2-141
	Clear the LCAS-RX-GRP-ERR Condition	2-141
2.7.188	LCAS-TX-ADD	2-141
2.7.189	LCAS-TX-DNU	2-141
2.7.190	LINK-KEEPALIVE	2-142
	Clear the LINK-KEEPALIVE Alarm	2-142
2.7.191	LKOUTPR-S	2-142
	Clear the LKOUTPR-S Condition	2-143
2.7.192	LMP-FAIL	2-143
	Clear the LMP-FAIL Alarm	2-143
2.7.193	LMP-SD	2-144
	Clear the LMP-SD Condition	2-145
2.7.194	LMP-SF	2-145
	Clear the LMP-SF Condition	2-146
2.7.195	LMP-UNALLOC	2-146
2.7.196	LOA	2-147
	Clear the LOA Alarm	2-147
2.7.197	LOCKOUT-REQ	2-147
	Clear the LOCKOUT-REQ Condition	2-148
2.7.198	LOF (BITS)	2-148
	Clear the LOF (BITS) Alarm	2-148
2.7.199	LOF (DS1)	2-149
	Clear the LOF (DS1) Alarm	2-149
2.7.200	LOF (DS3)	2-150
	Clear the LOF (DS3) Alarm	2-150
2.7.201	LOF (E1)	2-150
	Clear the LOF (E1) Alarm	2-151
2.7.202	LOF (EC1)	2-151
	Clear the LOF (EC1) Alarm	2-151
2.7.203	LOF (OCN)	2-152
	Clear the LOF (OCN) Alarm	2-152
2.7.204	LOF (STSTRM)	2-152
	Clear the LOF (STSTRM) Alarm	2-153

2.7.205	LOF (TRUNK)	2-153
2.7.206	LOGBUFR90	2-153
2.7.207	LOGBUFROVFL	2-153
	Clear the LOGBUFROVFL Alarm	2-153
2.7.208	LO-LASERBIAS	2-154
	Clear the LO-LASERBIAS Alarm	2-154
2.7.209	LO-LASERTEMP	2-154
	Clear the LO-LASERTEMP Alarm	2-155
2.7.210	LOM	2-155
	Clear the LOM Alarm	2-155
2.7.211	LOP-P	2-155
	Clear the LOP-P Alarm	2-156
2.7.212	LOP-V	2-156
	Clear the LOP-V Alarm	2-156
2.7.213	LO-RXPOWER	2-157
	Clear the LO-RXPOWER Alarm	2-157
2.7.214	LOS (2R)	2-158
2.7.215	LOS (BITS)	2-158
	Clear the LOS (BITS) Alarm	2-158
2.7.216	LOS (DS1)	2-159
	Clear the LOS (DS1) Alarm	2-159
2.7.217	LOS (DS3)	2-160
	Clear the LOS (DS3) Alarm	2-161
2.7.218	LOS (E1)	2-162
	Clear the LOS (E1) Alarm	2-162
2.7.219	LOS (EC1)	2-163
	Clear the LOS (EC1) Alarm	2-163
2.7.220	LOS (ESCON)	2-164
2.7.221	LOS (FUDC)	2-164
	Clear the LOS (FUDC) Alarm	2-164
2.7.222	LOS (ISC)	2-165
2.7.223	LOS (MSUDC)	2-165
2.7.224	LOS (OCN)	2-165
	Clear the LOS (OCN) Alarm	2-166
2.7.225	LOS (OTS)	2-167
2.7.226	LOS (TRUNK)	2-167
2.7.227	LOS-O	2-167
2.7.228	LOS-P (OCH)	2-167
2.7.229	LOS-P (OMS, OTS)	2-167
2.7.230	LOS-P (TRUNK)	2-167

2.7.231	LO-TXPOWER	2-167	
	Clear the LO-TXPOWER Alarm	2-168	
2.7.232	LPBKCRS	2-168	
	Clear the LPBKCRS Condition	2-168	
2.7.233	LPBKDS3FEAC	2-169	
	Clear the LPBKDS3FEAC Condition	2-169	
2.7.234	LPBKDS3FEAC-CMD	2-169	
2.7.235	LPBKFACILITY (CE1000, CE100T)	2-169	
	Clear the LPBKFACILITY (CE1000, CE100T) Condition	2-170	
2.7.236	LPBKFACILITY (DS1, DS3)	2-170	
	Clear the LPBKFACILITY (DS1, DS3) Condition	2-170	
2.7.237	LPBKFACILITY (E1)	2-171	
	Clear the LPBKFACILITY (E1) Condition	2-171	
2.7.238	LPBKFACILITY (EC1)	2-171	
	Clear the LPBKFACILITY (EC1) Condition	2-172	
2.7.239	LPBKFACILITY (ESCON)	2-172	
2.7.240	LPBKFACILITY (FC)	2-172	
2.7.241	LPBKFACILITY (FCMR)	2-172	
	Clear the LPBKFACILITY (FCMR) Condition	2-172	
2.7.242	LPBKFACILITY (G1000)	2-172	
	Clear the LPBKFACILITY (G1000) Condition	2-173	
2.7.243	LPBKFACILITY (GE)	2-173	
2.7.244	LPBKFACILITY (ISC)	2-173	
2.7.245	CLPBKFACILITY (OCN)	2-173	
	Clear the LPBKFACILITY (OCN) Condition	2-174	
2.7.246	LPBKFACILITY (TRUNK)	2-174	
2.7.247	LPBKTERMINAL (CE1000, CE100T)	2-174	
	Clear the LPBKTERMINAL (CE1000, CE100T) Condition	2-174	
2.7.248	LPBKTERMINAL (DS1, DS3)	2-175	
	Clear the LPBKTERMINAL (DS1, DS3) Condition	2-175	
2.7.249	LPBKTERMINAL (E1)	2-175	
	Clear the LPBKTERMINAL (E1) Condition	2-175	
2.7.250	LPBKTERMINAL (EC1)	2-175	
	Clear the LPBKTERMINAL (EC1) Condition	2-176	
2.7.251	LPBKTERMINAL (ESCON)	2-176	
2.7.252	LPBKTERMINAL (FC)	2-176	
2.7.253	LPBKTERMINAL (FCMR)	2-176	
	Clear the LPBKTERMINAL (FCMR) Condition	2-176	
2.7.254	LPBKTERMINAL (G1000)	2-177	
	Clear the LPBKTERMINAL (G1000) Condition	2-177	

2.7.255 LPBKTERMINAL (GE)	2-177
2.7.256 LPBKTERMINAL (ISC)	2-177
2.7.257 LPBKTERMINAL (OCN)	2-177
Clear the LPBKTERMINAL (OCN) Condition	2-178
2.7.258 LPBKTERMINAL (TRUNK)	2-178
2.7.259 LWBATVG	2-178
Clear the LWBATVG Alarm	2-178
2.7.260 MAN-REQ	2-179
Clear the MAN-REQ Condition	2-179
2.7.261 MANRESET	2-179
2.7.262 MANSWTOINT	2-179
2.7.263 MANSWTOPRI	2-180
2.7.264 MANSWTOSEC	2-180
2.7.265 MANSWTOTHIRD	2-180
2.7.266 MANUAL-REQ-RING	2-180
Clear the MANUAL-REQ-RING Condition	2-181
2.7.267 MANUAL-REQ-SPAN	2-181
Clear the MANUAL-REQ-SPAN Condition	2-181
2.7.268 MAX-STATIONS	2-181
Clear the MAX-STATIONS Alarm	2-182
2.7.269 MEA (AIP)	2-182
Clear the MEA (AIP) Alarm	2-182
2.7.270 MEA (BIC)	2-182
Clear the MEA (BIC) Alarm	2-183
2.7.271 MEA (EQPT)	2-183
Clear the MEA (EQPT) Alarm	2-184
2.7.272 MEA (FAN)	2-185
Clear the MEA (FAN) Alarm	2-186
2.7.273 MEA (PPM)	2-186
2.7.274 MEA (SHELF)	2-186
2.7.275 MEM-GONE	2-186
2.7.276 MEM-LOW	2-187
2.7.277 MFGMEM	2-187
Clear the MFGMEM Alarm	2-187
2.7.278 MS-DEG	2-188
2.7.279 MS-EXC	2-188
2.7.280 MT-OCHNC	2-188
2.7.281 NO-CONFIG	2-188
Clear the NO-CONFIG Condition	2-188
2.7.282 NON-CISCO-PPM	2-189

Clear the NON-CISCO-PPM Condition	2-189
2.7.283 NOT-AUTHENTICATED	2-189
2.7.284 OCHNC-INC	2-189
2.7.285 OCHTERM-INC	2-190
2.7.286 ODUK-1-AIS-PM	2-190
2.7.287 ODUK-2-AIS-PM	2-190
2.7.288 ODUK-3-AIS-PM	2-190
2.7.289 ODUK-4-AIS-PM	2-190
2.7.290 ODUK-AIS-PM	2-190
2.7.291 ODUK-BDI-PM	2-190
2.7.292 ODUK-LCK-PM	2-190
2.7.293 ODUK-OCI-PM	2-191
2.7.294 ODUK-SD-PM	2-191
2.7.295 ODUK-SF-PM	2-191
2.7.296 ODUK-TIM-PM	2-191
2.7.297 OOU-TPT	2-191
Clear the OOT-TPT Condition	2-191
2.7.298 OPEN-SLOT	2-191
Clear the OPEN-SLOT Condition	2-192
2.7.299 OPTNTWMIS	2-192
2.7.300 OPWR-HDEG	2-192
2.7.301 OPWR-HFAIL	2-192
2.7.302 OPWR-LDEG	2-192
2.7.303 OPWR-LFAIL	2-192
2.7.304 OSRION	2-192
2.7.305 OTUK-AIS	2-193
2.7.306 OTUK-BDI	2-193
2.7.307 OTUK-IAE	2-193
2.7.308 OTUK-LOF	2-193
2.7.309 OTUK-SD	2-193
2.7.310 OTUK-SF	2-193
2.7.311 OTUK-TIM	2-193
2.7.312 OUT-OF-SYNC	2-193
2.7.313 PARAM-MISM	2-194
2.7.314 PDI-P	2-194
Clear the PDI-P Condition	2-195
2.7.315 PEER-NORESPONSE	2-195
Clear the PEER-NORESPONSE Alarm	2-196
2.7.316 PLM-P	2-196
Clear the PLM-P Alarm	2-197

2.7.317	PLM-V	2-197	
	Clear the PLM-V Alarm	2-197	
2.7.318	PMI	2-197	
2.7.319	PORT-FAIL	2-198	
2.7.320	PORT-MISMATCH	2-198	
	Clear the PORT-MISMATCH Alarm	2-198	
2.7.321	PRC-DUPID	2-199	
	Clear the PRC-DUPID Alarm	2-199	
2.7.322	PROTNA	2-199	
	Clear the PROTNA Alarm	2-199	
2.7.323	PROV-MISMATCH	2-200	
2.7.324	PTIM	2-200	
2.7.325	PWR-FAIL-A	2-200	
	Clear the PWR-FAIL-A Alarm	2-200	
2.7.326	PWR-FAIL-B	2-201	
	Clear the PWR-FAIL-B Alarm	2-202	
2.7.327	PWR-FAIL-RET-A	2-202	
	Clear the PWR-FAIL-RET-A Alarm	2-202	
2.7.328	PWR-FAIL-RET-B	2-202	
	Clear the PWR-FAIL-RET-A Alarm	2-202	
2.7.329	RAI	2-203	
	Clear the RAI Condition	2-203	
2.7.330	RCVR-MISS	2-203	
	Clear the RCVR-MISS Alarm	2-203	
2.7.331	RSV-RT-EXCD-RINGLETO	2-204	
	Clear the RSV-RT-EXCD-RINGLETO Alarm	2-204	
2.7.332	RSV-RT-EXCD-RINGLET1	2-204	
	Clear the RSV-RT-EXCD-RINGLET1 Alarm	2-204	
2.7.333	RFI	2-205	
2.7.334	RFI-L	2-205	
	Clear the RFI-L Condition	2-205	
2.7.335	RFI-P	2-205	
	Clear the RFI-P Condition	2-206	
2.7.336	RFI-V	2-206	
	Clear the RFI-V Condition	2-206	
2.7.337	RING-ID-MIS	2-207	
	Clear the RING-ID-MIS Alarm	2-207	
2.7.338	RING-MISMATCH	2-208	
	Clear the RING-MISMATCH Alarm	2-208	
2.7.339	RING-SW-EAST	2-208	

2.7.340	RING-SW-WEST	2-208
2.7.341	ROLL	2-209
2.7.342	ROLL-PEND	2-209
2.7.343	ROUTE-OVERFLOW	2-209
	Clear the ROUTE-OVERFLOW Condition	2-210
2.7.344	RPR-PASSTHR	2-210
	Clear the RPR-PASSTHR Condition	2-211
2.7.345	RPR-PEER-MISS	2-211
	Clear the RPR-PEER-MISS Condition	2-211
2.7.346	RPR-PROT-ACTIVE	2-212
	Clear the RPR-PROT-ACTIVE Condition	2-213
2.7.347	RPR-PROT-CONFIG-MISM	2-213
	Clear the RPR-PROT-CONFIG-MISM Alarm	2-213
2.7.348	RPR-RI-FAIL	2-213
	Clear the RPR-RI-FAIL Condition	2-214
2.7.349	RPR-SD	2-214
	Clear the RPR-SD Condition	2-214
2.7.350	RPR-SF	2-215
	Clear the RPR-SF Condition	2-215
2.7.351	RPR-SPAN-MISMATCH	2-215
	Clear the RPR-SPAN-MISMATCH Alarm	2-216
2.7.352	RPRW	2-216
	Clear the RPRW Condition	2-217
2.7.353	RUNCFG-SAVENEED	2-217
2.7.354	SD (DS1, DS3)	2-218
	Clear the SD (DS1, DS3) Condition	2-218
2.7.355	SD (E1)	2-219
	Clear the SD (E1) Condition	2-220
2.7.356	SD (TRUNK)	2-221
2.7.357	SD-L	2-221
	Clear the SD-L Condition	2-221
2.7.358	SD-L (TRUNK)	2-221
2.7.359	SD-P	2-221
	Clear the SD-P Condition	2-222
2.7.360	SD-V	2-222
	Clear the SD-V Condition	2-222
2.7.361	SF (DS1, DS3)	2-222
	Clear the SF (DS1, DS3) Condition	2-223
2.7.362	SF (E1)	2-223
	Clear the SF (E1) Condition	2-224

2.7.363 SF (TRUNK)	2-224
2.7.364 SF-L	2-224
Clear the SF-L Condition	2-224
2.7.365 SF-L (TRUNK)	2-224
2.7.366 SF-P	2-225
Clear the SF-P Condition	2-225
2.7.367 SFTWDOWN	2-225
2.7.368 SF-V	2-226
Clear the SF-V Condition	2-226
2.7.369 SHELF-COMM-FAIL	2-226
2.7.370 SH-IL-VAR-DEG-HIGH	2-226
2.7.371 SH-IL-VAR-DEG-LOW	2-226
2.7.372 SHUTTER-OPEN	2-226
2.7.373 SIGLOSS	2-226
Clear the SIGLOSS Alarm	2-227
2.7.374 SNTP-HOST	2-227
Clear the SNTP-HOST Alarm	2-227
2.7.375 SPANLEN-OUT-OF-RANGE	2-228
2.7.376 SPAN-SW-EAST	2-228
2.7.377 SPAN-SW-WEST	2-228
2.7.378 SQUELCH	2-228
Clear the SQUELCH Condition	2-229
2.7.379 SQUELCHED	2-230
Clear the SQUELCHED Condition	2-231
2.7.380 SQM	2-232
Clear the SQM Alarm	2-232
2.7.381 SSM-DUS	2-232
2.7.382 SSM-FAIL	2-233
Clear the SSM-FAIL Alarm	2-233
2.7.383 SSM-LNC	2-233
2.7.384 SSM-OFF	2-234
Clear the SSM-OFF Condition	2-234
2.7.385 SSM-PRC	2-234
2.7.386 SSM-PRS	2-234
2.7.387 SSM-RES	2-234
2.7.388 SSM-SDH-TN	2-235
2.7.389 SSM-SETS	2-235
2.7.390 SSM-SMC	2-235
2.7.391 SSM-ST2	2-235
2.7.392 SSM-ST3	2-235

2.7.393	SSM-ST3E	2-236
2.7.394	SSM-ST4	2-236
2.7.395	SSM-STU	2-236
	Clear the SSM-STU Condition	2-237
2.7.396	SSM-TNC	2-237
2.7.397	STS-SQUELCH-L	2-237
2.7.398	SW-MISMATCH	2-237
	Clear the SW-MISMATCH Condition	2-238
2.7.399	SWMTXMOD-PROT	2-238
	Clear the SWMTXMOD-PROT Alarm	2-238
2.7.400	SWMTXMOD-WORK	2-239
	Clear the SWMTXMOD-WORK Alarm	2-239
2.7.401	SWTOPRI	2-239
2.7.402	SWTOSEC	2-240
	Clear the SWTOSEC Condition	2-240
2.7.403	SWTOTHIRD	2-240
	Clear the SWTOTHIRD Condition	2-240
2.7.404	SYNC-FREQ	2-240
	Clear the SYNC-FREQ Condition	2-241
2.7.405	SYNCLOSS	2-241
	Clear the SYNCLOSS Alarm	2-241
2.7.406	SYNCPRI	2-242
	Clear the SYNCPRI Alarm	2-242
2.7.407	SYNCSEC	2-242
	Clear the SYNCSEC Alarm	2-243
2.7.408	SYNCTHIRD	2-243
	Clear the SYNCTHIRD Alarm	2-243
2.7.409	SYSBOOT	2-244
2.7.410	TEMP-MISM	2-244
	Clear the TEMP-MISM Condition	2-244
2.7.411	TIM	2-245
	Clear the TIM Alarm	2-245
2.7.412	TIM-MON	2-246
	Clear the TIM-MON Alarm	2-246
2.7.413	TIM-P	2-246
	Clear the TIM-P Alarm	2-246
2.7.414	TIM-S	2-247
	Clear the TIM-S Alarm	2-247
2.7.415	TIM-V	2-247
	Clear the TIM-V Alarm	2-248

- 2.7.416 TPTFAIL (CE100T, CE1000) 2-248
 - Clear the TPTFAIL (CE100T, CE1000) Alarm 2-248
- 2.7.417 TPTFAIL (FCMR) 2-248
 - Clear the TPTFAIL (FCMR) Alarm 2-249
- 2.7.418 TPTFAIL (G1000) 2-249
 - Clear the TPTFAIL (G1000) Alarm 2-249
- 2.7.419 TPTFAIL (ML100T, ML1000, MLFX) 2-250
 - Clear the TPTFAIL (ML100T, ML1000, MLFX) Alarm 2-250
- 2.7.420 TRMT 2-251
 - Clear the TRMT Alarm 2-251
- 2.7.421 TRMT-MISS 2-251
 - Clear the TRMT-MISS Alarm 2-251
- 2.7.422 TX-AIS 2-251
 - Clear the TX-AIS Condition 2-252
- 2.7.423 TX-LOF 2-252
 - Clear the TX-LOF Condition 2-252
- 2.7.424 TX-RAI 2-252
 - Clear the TX-RAI Condition 2-253
- 2.7.425 UNC-WORD 2-253
- 2.7.426 UNEQ-P 2-253
 - Clear the UNEQ-P Alarm 2-253
- 2.7.427 UNEQ-V 2-255
 - Clear the UNEQ-V Alarm 2-255
- 2.7.428 UNQUAL-PPM 2-255
 - Clear the UNQUAL-PPM Condition 2-256
- 2.7.429 UT-COMM-FAIL 2-256
- 2.7.430 UT-FAIL 2-256
- 2.7.431 VCG-DEG 2-256
 - Clear the VCG-DEG Condition 2-256
- 2.7.432 VCG-DOWN 2-257
 - Clear the VCG-DOWN Condition 2-257
- 2.7.433 VOA-HDEG 2-257
- 2.7.434 VOA-HFAIL 2-257
- 2.7.435 VOA-LDEG 2-257
- 2.7.436 VOA-LFAIL 2-258
- 2.7.437 VOLT-MISM 2-258
 - Clear the VOLT-MISM Condition 2-258
- 2.7.438 VT-SQUELCH-L 2-258
- 2.7.439 WKSWPR 2-258
 - Clear the WKSWPR Condition 2-259

- 2.7.440 WTR **2-259**
 - Clear the WTR Condition on an IEEE 802.17b-Based RPR Span **2-259**
- 2.7.441 WVL-MISMATCH **2-260**
- 2.8 Traffic Card LED Activity **2-260**
 - 2.8.1 Typical Traffic Card LED Activity After Insertion **2-260**
 - 2.8.2 Typical Traffic Card LED Activity During Reset **2-260**
 - 2.8.3 Typical Card LED State After Successful Reset **2-260**
 - 2.8.4 Typical Cross-Connect LED Activity During Side Switch **2-261**
- 2.9 Frequently Used Alarm Troubleshooting Procedures **2-261**
 - 2.9.1 Node and Ring Identification, Change, Visibility, and Termination **2-261**
 - Identify a BLSR Ring Name or Node ID Number **2-261**
 - Change a BLSR Ring Name **2-261**
 - Change a BLSR Node ID Number **2-262**
 - Verify Node Visibility for Other Nodes **2-262**
 - 2.9.2 Protection Switching, Lock Initiation, and Clearing **2-262**
 - Initiate a 1+1 Force Switch Command **2-262**
 - Initiate a 1+1 Manual Switch Command **2-263**
 - Clear a 1+1 Force or Manual Switch Command **2-264**
 - Initiate a Lock-On Command **2-264**
 - Initiate a Card or Port Lockout Command **2-265**
 - Clear a Lock-On or Lockout Command **2-265**
 - Initiate a 1:1 Card Switch Command **2-265**
 - Initiate a Force Switch for All Circuits on a Path Protection Span **2-266**
 - Initiate a Manual Switch for All Circuits on a Path Protection Span **2-266**
 - Initiate a Lockout for All Circuits on a Protect Path Protection Span **2-267**
 - Clear an External Switching Command on a Path Protection Span **2-267**
 - Initiate a Force Ring Switch on a BLSR **2-268**
 - Initiate a Force Span Switch on a Four-Fiber BLSR **2-268**
 - Initiate a Manual Span Switch on a BLSR **2-268**
 - Initiate a Manual Ring Switch on a BLSR **2-269**
 - Initiate a Lockout on a BLSR Protect Span **2-269**
 - Initiate an Exercise Ring Switch on a BLSR **2-269**
 - Initiate an Exercise Ring Switch on a Four Fiber BLSR **2-270**
 - Clear a BLSR External Switching Command **2-270**
 - 2.9.3 CTC Card Resetting and Switching **2-270**
 - Reset a Traffic Card in CTC **2-271**
 - Reset an Active TCC2/TCC2P Card and Activate the Standby Card **2-271**
 - Side Switch the Active and Standby Cross-Connect Cards **2-272**
 - 2.9.4 Physical Card Reseating, Resetting, and Replacement **2-272**
 - Remove and Reinsert (Reseat) the Standby TCC2/TCC2P Card **2-273**

Remove and Reinsert (Reseat) Any Card	2-274
Physically Replace a Traffic Card	2-274
Physically Replace an In-Service Cross-Connect Card	2-274
2.9.5 Generic Signal and Circuit Procedures	2-275
Verify the Signal BER Threshold Level	2-275
Delete a Circuit	2-276
Verify or Create Node Section DCC Terminations	2-276
Clear an OC-N Card Facility or Terminal Loopback Circuit	2-276
Clear an OC-N Card Cross-Connect (XC) Loopback Circuit	2-277
Clear a DS3XM-6, DS3XM-12, or DS3E-12 Card Loopback Circuit	2-277
Clear Other Electrical Card or Ethernet Card Loopbacks	2-278
Clear an MXP, TXP, or FC_MR-4 Card Loopback Circuit	2-278
2.9.6 Air Filter and Fan Procedures	2-279
Inspect, Clean, and Replace the Reusable Air Filter	2-279
Remove and Reinsert a Fan-Tray Assembly	2-280
Replace the Fan-Tray Assembly	2-281
2.9.7 Interface Procedures	2-282
Replace the Electrical Interface Assembly	2-282
Replace the Alarm Interface Panel	2-282

CHAPTER 3**Transient Conditions 3-1**

3.1 Transients Indexed By Alphabetical Entry	3-1
3.2 Trouble Notifications	3-3
3.2.1 Condition Characteristics	3-3
3.2.2 Condition States	3-4
3.3 Transient Conditions	3-4
3.3.1 ADMIN-DISABLE	3-4
3.3.2 ADMIN-DISABLE-CLR	3-4
3.3.3 ADMIN-LOCKOUT	3-4
3.3.4 ADMIN-LOCKOUT-CLR	3-4
3.3.5 ADMIN-LOGOUT	3-5
3.3.6 ADMIN-SUSPEND	3-5
3.3.7 ADMIN-SUSPEND-CLR	3-5
3.3.8 AUD-ARCHIVE-FAIL	3-5
3.3.9 AUTOWDMANS	3-5
3.3.10 BLSR-RESYNC	3-5
3.3.11 DBBACKUP-FAIL	3-5
3.3.12 DBRESTORE-FAIL	3-6
3.3.13 EFM-ERR-FRM	3-6

3.3.14	EFM-FRM-PER	3-6
3.3.15	EFM-FRM-SEC	3-6
3.3.16	EFM-RLBK-FAIL	3-6
3.3.17	EFM-SYM-PER	3-7
3.3.18	FIREWALL-DIS	3-7
3.3.19	FRCDWKSWBK-NO-TRFSW	3-7
3.3.20	FRCDWKSWPR-NO-TRFSW	3-7
3.3.21	INTRUSION	3-7
3.3.22	IOSCFG-COPY-FAIL	3-7
3.3.23	LOGIN-FAIL-LOCKOUT	3-8
3.3.24	LOGIN-FAIL-ONALRDY	3-8
3.3.25	LOGIN-FAILURE-PSWD	3-8
3.3.26	LOGOUT-IDLE-USER	3-8
3.3.27	MANWKSWBK-NO-TRFSW	3-8
3.3.28	MANWKSWPR-NO-TRFSW	3-8
3.3.29	PM-TCA	3-8
3.3.30	PS	3-9
3.3.31	RMON-ALARM	3-9
3.3.32	RMON-RESET	3-9
3.3.33	SFTWDOWN-FAIL	3-9
3.3.34	USER-LOCKOUT	3-9
3.3.35	USER-LOGIN	3-9
3.3.36	USER-LOGOUT	3-9
3.3.37	WKSWBK	3-10
3.3.38	WKSWPR	3-10
3.3.39	WTR-SPAN	3-10

CHAPTER 4

Error Messages 4-1

INDEX



FIGURES

<i>Figure 1-1</i>	Facility Loopback Path on a Near-End DS-N Card	1-3
<i>Figure 1-2</i>	Facility Loopback Path on a Near-End OC-N Card	1-3
<i>Figure 1-3</i>	OC-N Facility Loopback Indicator	1-3
<i>Figure 1-4</i>	Terminal Loopback Path on an OC-N Card	1-5
<i>Figure 1-5</i>	Terminal Loopback Indicator	1-5
<i>Figure 1-6</i>	Terminal Loopback Path on a DS-N Card	1-6
<i>Figure 1-7</i>	Terminal Loopback on a DS-N Card with a Bridged Signal	1-7
<i>Figure 1-8</i>	Terminal Loopback on an OC-N Card with a Bridged Signal	1-7
<i>Figure 1-9</i>	Hairpin Circuit Path on a DS-N Card	1-8
<i>Figure 1-10</i>	Network Element with SONET Cross-Connect Loopback Function	1-9
<i>Figure 1-11</i>	Facility Loopback on a Circuit Source DS-N Port	1-10
<i>Figure 1-12</i>	Hairpin on a Source-Node Port	1-15
<i>Figure 1-13</i>	XC Loopback on a Destination OC-N Port	1-19
<i>Figure 1-14</i>	Terminal Loopback to a Destination DS-N Port	1-22
<i>Figure 1-15</i>	Facility Loopback on a Circuit Destination DS-N Port	1-28
<i>Figure 1-16</i>	Hairpin on a Destination-Node DS-N Port	1-33
<i>Figure 1-17</i>	XC Loopback on a Source OC-N Port	1-37
<i>Figure 1-18</i>	Terminal Loopback on a Source DS-N Port	1-40
<i>Figure 1-19</i>	Accessing FEAC Functions on the DS3XM-6 Card	1-46
<i>Figure 1-20</i>	Diagram of FEAC Circuit	1-46
<i>Figure 1-21</i>	Facility Loopback on a Circuit Source OC-N Port	1-48
<i>Figure 1-22</i>	Terminal Loopback on a Source-Node OC-N Port	1-50
<i>Figure 1-23</i>	Terminal Loopback Indicator	1-50
<i>Figure 1-24</i>	XC Loopback on a Source OC-N Port	1-53
<i>Figure 1-25</i>	Facility Loopback Path to an Intermediate-Node OC-N Port	1-57
<i>Figure 1-26</i>	Terminal Loopback Path to an Intermediate-Node OC-N Port	1-60
<i>Figure 1-27</i>	Facility Loopback Indicator	1-60
<i>Figure 1-28</i>	Facility Loopback Path to a Destination-Node OC-N Port	1-63
<i>Figure 1-29</i>	Terminal Loopback Path to a Destination-Node OC-N Port	1-66
<i>Figure 1-30</i>	Facility Loopback on a Circuit Source Ethernet Port	1-69
<i>Figure 1-31</i>	Terminal Loopback on a G-Series Port	1-72

<i>Figure 1-32</i>	Hairpin on a Source-Node Ethernet Port	1-75
<i>Figure 1-33</i>	Facility Loopback on an Intermediate-Node Ethernet Port	1-78
<i>Figure 1-34</i>	Terminal Loopback on an Intermediate-Node Ethernet Port	1-81
<i>Figure 1-35</i>	Facility Loopback on a Destination-Node Ethernet Port	1-84
<i>Figure 1-36</i>	Terminal Loopback on a Destination-Node Ethernet Port	1-87
<i>Figure 1-37</i>	Hairpin on a Destination-Node Ethernet Port	1-90
<i>Figure 1-38</i>	Facility Loopback on a Circuit Source FC_MR Port	1-94
<i>Figure 1-39</i>	Terminal Loopback on a Source-Node FC_MR Port	1-97
<i>Figure 1-40</i>	Facility Loopback on an Intermediate-Node FC_MR Port	1-99
<i>Figure 1-41</i>	Terminal Loopback on an Intermediate-Node FC_MR Port	1-101
<i>Figure 1-42</i>	Facility Loopback on a Destination-Node FC_MR Port	1-103
<i>Figure 1-43</i>	Terminal Loopback on a Destination-Node FC_MR Port	1-105
<i>Figure 1-44</i>	CTC Node View Diagnostic Window	1-108
<i>Figure 1-45</i>	CTC Node View Diagnostic Window	1-111
<i>Figure 1-46</i>	Network View Circuit Creation Dialog Box	1-112
<i>Figure 1-47</i>	DCN Tools OSPF Dump	1-114
<i>Figure 1-48</i>	Deleting the CTC Cache	1-125
<i>Figure 1-49</i>	Ethernet Connectivity Reference	1-131
<i>Figure 1-50</i>	VLAN with Ethernet Ports at Tagged and Untag	1-133
<i>Figure 1-51</i>	Configuring VLAN Membership for Individual Ethernet Ports	1-133
<i>Figure 1-52</i>	RJ-45 Pin Numbers	1-141
<i>Figure 1-53</i>	LAN Cable Layout	1-142
<i>Figure 1-54</i>	Cross-Over Cable Layout	1-142
<i>Figure 1-55</i>	GBICs	1-143
<i>Figure 2-1</i>	Shelf LCD Panel	2-50
<i>Figure 2-2</i>	Shelf LCD Panel	2-126
<i>Figure 4-1</i>	Error Dialog Box	4-1



TABLES

<i>Table 1-1</i>	ONS 15454 Card Facility Loopback Behavior	1-4
<i>Table 1-2</i>	ONS 15454 Card Terminal Loopback Behavior	1-6
<i>Table 1-3</i>	JRE Compatibility	1-127
<i>Table 1-4</i>	LAN Cable Pinout	1-142
<i>Table 1-5</i>	Cross-Over Cable Pinout	1-142
<i>Table 1-6</i>	Optical Card Transmit and Receive Levels	1-146
<i>Table 2-1</i>	ONS 15454 Critical Alarm List	2-2
<i>Table 2-2</i>	ONS 15454 Major Alarm List	2-3
<i>Table 2-3</i>	ONS 15454 Minor Alarm List	2-4
<i>Table 2-4</i>	ONS 15454 NA Conditions List	2-6
<i>Table 2-5</i>	ONS 15454 NR Conditions List	2-11
<i>Table 2-6</i>	ONS 15454 Alarm and Condition Alphabetical List	2-11
<i>Table 2-7</i>	Alarm Logical Object Type Definitions	2-20
<i>Table 2-8</i>	Alarm List by Logical Object in Alarm Profile	2-23
<i>Table 2-9</i>	Path Alarm Hierarchy	2-34
<i>Table 2-10</i>	Facility Alarm Hierarchy	2-34
<i>Table 2-11</i>	Near-End Alarm Hierarchy	2-34
<i>Table 2-12</i>	Far-End Alarm Hierarchy	2-35
<i>Table 2-13</i>	Transponder Trunk Alarms that Cause LMP-SD	2-145
<i>Table 2-14</i>	Transponder Client Alarm that Causes LMP-SD	2-145
<i>Table 2-15</i>	Transponder Card Alarms that Cause LMP-SF	2-146
<i>Table 2-16</i>	Transponder Trunk Alarms that Cause LMP-SF	2-146
<i>Table 2-17</i>	Transponder Client Alarms that Cause LMP-SF	2-146
<i>Table 2-18</i>	BIC Compatibility Matrix	2-183
<i>Table 3-1</i>	ONS 15454 Transient Condition Alphabetical Index	3-1
<i>Table 4-1</i>	Error Messages	4-1



About this Guide



Note

The terms "Unidirectional Path Switched Ring" and "UPSR" may appear in Cisco literature. These terms do not refer to using Cisco ONS 15xxx products in a unidirectional path switched ring configuration. Rather, these terms, as well as "Path Protected Mesh Network" and "PPMN," refer generally to Cisco's path protection feature, which may be used in any topological network configuration. Cisco does not recommend using its path protection feature in any particular topological network configuration.

This section explains the objectives, intended audience, and organization of this publication and describes the conventions that convey instructions and other information.

This section provides the following information:

- [Revision History](#)
- [Document Objectives](#)
- [Audience](#)
- [Related Documentation](#)
- [Document Conventions](#)
- [Obtaining Optical Networking Information](#)
- [Obtaining Documentation and Submitting a Service Request](#)

Revision History

Date	Notes
March 2007	Added Revision History table. Added CE-Series Ethernet card information to Tables 1-1 and 1-2 in the "General Troubleshooting" chapter. Changed description for LOA and VCG-DOWN alarms, and description and alarm-clearing procedure for LOM alarm in the "Alarm Troubleshooting" chapter.
April 2007	Added additional description for APSCM alarm in the "Alarm Troubleshooting" chapter.
June 2007	Updated About this Guide Chapter.

Date	Notes
September 2007	Replaced TX Power High column name with OPT-HIGH in the HI-TX Power section of the “Alarm Troubleshooting” chapter. Added Ethernet ports to which the GFP-LFD alarm applies to, in the GFP-LFD section of the “Alarm Troubleshooting” chapter. Changed the alarm severity of RPR-PEER-MISS and RPR-RI-FAIL alarms from Not Alarmed (NA) to Major (MJ). Added the ROUTE-OVERFLOW alarm to the “Alarm Troubleshooting” chapter. Updated the caution in the Side Switch the Active and Standby Cross-Connect Cards section of the “Alarm Troubleshooting” chapter. Added a note, caution, and rule in the Side Switch the Active and Standby Cross-Connect Cards section of the “Alarm Troubleshooting” chapter.
October 2007	Updated About this Guide Chapter
November 2007	Updated APC-DISABLED alarm details in the "Alarms and Conditions Listed By Alphabetical Entry" and "Alarm List by Logical Object Type" sections of Chapter 2, Alarm Troubleshooting.
April 2008	Added EID-6147 and EID-6148 in Error Messages chapter.
June 2008	Updated FAILTOSW alarm in Chapter 2, Alarm Troubleshooting.
February 2009	Updated PORT-MISMATCH alarm details in Chapter 2, Alarm Troubleshooting.
March 2009	Deleted references to the ADD-OPWR-HDEG, ADD-OPWR-LDEG, ADD-OPWR-HFAIL, and ADD-OPWR-LFAIL Alarms in Chapter 2, Alarm Troubleshooting.
June 2009	Updated PWR-FAIL-A, PWR-FAIL-B, PWR-FAIL-RET-A, and PWR-FAIL-RET-B alarm details in Chapter 2, Alarm Troubleshooting.
July 2009	Updated the COMIOXC alarm details in Chapter 2, Alarm Troubleshooting.
August 2009	Updated MEM-GONE alarm description in Chapter 2, Alarm Troubleshooting.
November 2009	<ul style="list-style-type: none"> • Updated the card details for LCAS alarms in Chapter 2, Alarm Troubleshooting. • Added a caution in “Perform a Terminal Loopback on a Destination Electrical Port (West to East)” and “Perform a Terminal Loopback on a Source-Node Electrical Port (East to West)” sections in the chapter, “General Troubleshooting”. • Added a note in “TX-RAI” section in the chapter, “Alarm Troubleshooting”.
June 2010	Updated the table “Alarm Logical Object Type Definitions” in the chapter “Alarm Troubleshooting”.
July 2010	Updated table in Chapter Error Messages.
September 2010	Updated the “Clear the COMIOXC Alarm” procedure in the chapter, “Alarm Troubleshooting”.

Document Objectives

This guide gives general troubleshooting instructions, alarm troubleshooting instructions, equipment replacement instructions, and a list of error messages that apply to the ONS 15454. This information is contained in four chapters. Use this guide in conjunction with the appropriate publications listed in the [Related Documentation](#) section.

Audience

To use this publication, you should be familiar with Cisco or equivalent optical transmission hardware and cabling, telecommunications hardware and cabling, electronic circuitry and wiring practices, and preferably have experience as a telecommunications technician.

Related Documentation

Use the *Cisco ONS 15454 Troubleshooting Guide* in conjunction with the following publications:

- *Cisco ONS 15454 Procedure Guide*
Provides procedures to install, turn up, test, and maintain an ONS 15454 node and network.
- *Cisco ONS 15454 Reference Manual*
Provides card, node, and network-level reference information, including specifications and network element defaults.
- *Cisco ONS 15454 DWDM Procedure Guide*
Provides procedures to install, turn-up, test, and maintain an ONS 15454 ANSI (SONET) or ETSI (SDH) shelf in a DWDM network.
- *Cisco ONS 15454 DWDM Reference Manual*
Provides card, node, and network-level reference information for ONS 15454 DWDM configurations.
- *Cisco ONS SONET TL1 Command Guide*
Provides a full TL1 command and autonomous message set including parameters, AIDs, conditions and modifiers for the Cisco ONS 15454, ONS 15327, ONS 15600, ONS 15310-CL, and ONS 15310-MA systems.
- *Cisco ONS SONET TL1 Reference Guide*
Provides general information, procedures, and errors for TL1 in the Cisco ONS 15454, ONS 15327, ONS 15600, ONS 15310-CL, and ONS 15310-MA systems.
- *Cisco ONS 15454 and Cisco ONS 15454 SDH Ethernet Card Software Feature and Configuration Guide*
Provides software features for all Ethernet cards and configuration information for Cisco IOS on ML-Series cards.
- *Release Notes for the Cisco ONS 15454 Release 8.0*
Provides caveats, closed issues, and new feature and functionality information.

Refer to the following standards documentation referenced in this publication:

- Telcordia GR-253 CORE

For an update on End-of-Life and End-of-Sale notices, refer to http://cisco.com/en/US/products/hw/optical/ps2006/prod_eol_notices_list.html.

Document Conventions

This publication uses the following conventions:

Convention	Application
boldface	Commands and keywords in body text.
<i>italic</i>	Command input that is supplied by the user.
[]	Keywords or arguments that appear within square brackets are optional.
{ x x x }	A choice of keywords (represented by x) appears in braces separated by vertical bars. The user must select one.
Ctrl	The control key. For example, where Ctrl + D is written, hold down the Control key while pressing the D key.
screen font	Examples of information displayed on the screen.
boldface screen font	Examples of information that the user must enter.
< >	Command parameters that must be replaced by module-specific codes.

**Note**

Means *reader take note*. Notes contain helpful suggestions or references to material not covered in the document.

**Caution**

Means *reader be careful*. In this situation, the user might do something that could result in equipment damage or loss of data.



Warning

IMPORTANT SAFETY INSTRUCTIONS

This warning symbol means danger. You are in a situation that could cause bodily injury. Before you work on any equipment, be aware of the hazards involved with electrical circuitry and be familiar with standard practices for preventing accidents. Use the statement number provided at the end of each warning to locate its translation in the translated safety warnings that accompanied this device. Statement 1071

SAVE THESE INSTRUCTIONS

Waarschuwing

BELANGRIJKE VEILIGHEIDSINSTRUCTIES

Dit waarschuwingssymbool betekent gevaar. U verkeert in een situatie die lichamelijk letsel kan veroorzaken. Voordat u aan enige apparatuur gaat werken, dient u zich bewust te zijn van de bij elektrische schakelingen betrokken risico's en dient u op de hoogte te zijn van de standaard praktijken om ongelukken te voorkomen. Gebruik het nummer van de verklaring onderaan de waarschuwing als u een vertaling van de waarschuwing die bij het apparaat wordt geleverd, wilt raadplegen.

BEWAAR DEZE INSTRUCTIES

Varoitus

TÄRKEITÄ TURVALLISUUSOHJEITA

Tämä varoitusmerkki merkitsee vaaraa. Tilanne voi aiheuttaa ruumiillisia vammoja. Ennen kuin käsittelet laitteistoa, huomioi sähköpiirien käsittelyyn liittyvät riskit ja tutustu onnettomuuksien yleisiin ehkäisytapoihin. Turvallisuusvaroitusten käännökset löytyvät laitteen mukana toimitettujen käännettyjen turvallisuusvaroitusten joukosta varoitusten lopussa näkyvien lausuntonumeroiden avulla.

SÄILYTÄ NÄMÄ OHJEET

Attention

IMPORTANTES INFORMATIONS DE SÉCURITÉ

Ce symbole d'avertissement indique un danger. Vous vous trouvez dans une situation pouvant entraîner des blessures ou des dommages corporels. Avant de travailler sur un équipement, soyez conscient des dangers liés aux circuits électriques et familiarisez-vous avec les procédures couramment utilisées pour éviter les accidents. Pour prendre connaissance des traductions des avertissements figurant dans les consignes de sécurité traduites qui accompagnent cet appareil, référez-vous au numéro de l'instruction situé à la fin de chaque avertissement.

CONSERVEZ CES INFORMATIONS

Warnung

WICHTIGE SICHERHEITSHINWEISE

Dieses Warnsymbol bedeutet Gefahr. Sie befinden sich in einer Situation, die zu Verletzungen führen kann. Machen Sie sich vor der Arbeit mit Geräten mit den Gefahren elektrischer Schaltungen und den üblichen Verfahren zur Vorbeugung vor Unfällen vertraut. Suchen Sie mit der am Ende jeder Warnung angegebenen Anweisungsnummer nach der jeweiligen Übersetzung in den übersetzten Sicherheitshinweisen, die zusammen mit diesem Gerät ausgeliefert wurden.

BEWAHREN SIE DIESE HINWEISE GUT AUF.

Avvertenza IMPORTANTI ISTRUZIONI SULLA SICUREZZA

Questo simbolo di avvertenza indica un pericolo. La situazione potrebbe causare infortuni alle persone. Prima di intervenire su qualsiasi apparecchiatura, occorre essere al corrente dei pericoli relativi ai circuiti elettrici e conoscere le procedure standard per la prevenzione di incidenti. Utilizzare il numero di istruzione presente alla fine di ciascuna avvertenza per individuare le traduzioni delle avvertenze riportate in questo documento.

CONSERVARE QUESTE ISTRUZIONI**Advarsel VIKTIGE SIKKERHETSINSTRUKSJONER**

Dette advarselssymbolet betyr fare. Du er i en situasjon som kan føre til skade på person. Før du begynner å arbeide med noe av utstyret, må du være oppmerksom på farene forbundet med elektriske kretser, og kjenne til standardprosedyrer for å forhindre ulykker. Bruk nummeret i slutten av hver advarsel for å finne oversettelsen i de oversatte sikkerhetsadvarslene som fulgte med denne enheten.

TA VARE PÅ DISSE INSTRUKSJONENE**Aviso INSTRUÇÕES IMPORTANTES DE SEGURANÇA**

Este símbolo de aviso significa perigo. Você está em uma situação que poderá ser causadora de lesões corporais. Antes de iniciar a utilização de qualquer equipamento, tenha conhecimento dos perigos envolvidos no manuseio de circuitos elétricos e familiarize-se com as práticas habituais de prevenção de acidentes. Utilize o número da instrução fornecido ao final de cada aviso para localizar sua tradução nos avisos de segurança traduzidos que acompanham este dispositivo.

GUARDE ESTAS INSTRUÇÕES**¡Advertencia! INSTRUCCIONES IMPORTANTES DE SEGURIDAD**

Este símbolo de aviso indica peligro. Existe riesgo para su integridad física. Antes de manipular cualquier equipo, considere los riesgos de la corriente eléctrica y familiarícese con los procedimientos estándar de prevención de accidentes. Al final de cada advertencia encontrará el número que le ayudará a encontrar el texto traducido en el apartado de traducciones que acompaña a este dispositivo.

GUARDE ESTAS INSTRUCCIONES**Varning! VIKTIGA SÄKERHETSANVISNINGAR**

Denna varningssignal signalerar fara. Du befinner dig i en situation som kan leda till personskada. Innan du utför arbete på någon utrustning måste du vara medveten om farorna med elkretsar och känna till vanliga förfaranden för att förebygga olyckor. Använd det nummer som finns i slutet av varje varning för att hitta dess översättning i de översatta säkerhetsvarningar som medföljer denna anordning.

SPARA DESSA ANVISNINGAR

FONTOS BIZTONSÁGI ELOÍRÁSOK

Ez a figyelmeztető jel veszélyre utal. Sérülésveszélyt rejtő helyzetben van. Mielott bármely berendezésen munkát végezte, legyen figyelemmel az elektromos áramkörök okozta kockázatokra, és ismerkedjen meg a szokásos balesetvédelmi eljárásokkal. A kiadványban szereplő figyelmeztetések fordítása a készülékhez mellékelt biztonsági figyelmeztetések között található; a fordítás az egyes figyelmeztetések végén látható szám alapján kereshető meg.

ORIZZE MEG EZEKET AZ UTASÍTÁSOKAT!

Предупреждение

ВАЖНЫЕ ИНСТРУКЦИИ ПО СОБЛЮДЕНИЮ ТЕХНИКИ БЕЗОПАСНОСТИ

Этот символ предупреждения обозначает опасность. То есть имеет место ситуация, в которой следует опасаться телесных повреждений. Перед эксплуатацией оборудования выясните, каким опасностям может подвергаться пользователь при использовании электрических цепей, и ознакомьтесь с правилами техники безопасности для предотвращения возможных несчастных случаев. Воспользуйтесь номером заявления, приведенным в конце каждого предупреждения, чтобы найти его переведенный вариант в переводе предупреждений по безопасности, прилагаемом к данному устройству.

СОХРАНИТЕ ЭТИ ИНСТРУКЦИИ

警告

重要的安全性说明

此警告符号代表危险。您正处于可能受到严重伤害的工作环境中。在您使用设备开始工作之前，必须充分意识到触电的危险，并熟练掌握防止事故发生的标准工作程序。请根据每项警告结尾提供的声明号码来找到此设备的安全性警告说明的翻译文本。

请保存这些安全性说明

警告

安全上の重要な注意事項

「危険」の意味です。人身事故を予防するための注意事項が記述されています。装置の取り扱い作業を行うときは、電気回路の危険性に注意し、一般的な事故防止策に留意してください。警告の各国語版は、各注意事項の番号を基に、装置に付属の「Translated Safety Warnings」を参照してください。

これらの注意事項を保管しておいてください。

주의

중요 안전 지침

이 경고 기호는 위험을 나타냅니다. 작업자가 신체 부상을 일으킬 수 있는 위험한 환경에 있습니다. 장비에 작업을 수행하기 전에 전기 회로와 관련된 위험을 숙지하고 표준 작업 관례를 숙지하여 사고를 방지하십시오. 각 경고의 마지막 부분에 있는 경고문 번호를 참조하여 이 장치와 함께 제공되는 번역된 안전 경고문에서 해당 번역문을 찾으십시오.

이 지시 사항을 보관하십시오.

Aviso INSTRUÇÕES IMPORTANTES DE SEGURANÇA

Este símbolo de aviso significa perigo. Você se encontra em uma situação em que há risco de lesões corporais. Antes de trabalhar com qualquer equipamento, esteja ciente dos riscos que envolvem os circuitos elétricos e familiarize-se com as práticas padrão de prevenção de acidentes. Use o número da declaração fornecido ao final de cada aviso para localizar sua tradução nos avisos de segurança traduzidos que acompanham o dispositivo.

GUARDE ESTAS INSTRUÇÕES**Advarsel VIGTIGE SIKKERHEDSANVISNINGER**

Dette advarselssymbol betyder fare. Du befinder dig i en situation med risiko for legemeskade. Før du begynder arbejde på udstyr, skal du være opmærksom på de involverede risici, der er ved elektriske kredsløb, og du skal sætte dig ind i standardprocedurer til undgåelse af ulykker. Brug erklæringsnummeret efter hver advarsel for at finde oversættelsen i de oversatte advarsler, der fulgte med denne enhed.

GEM DISSE ANVISNINGER

تحذير

إرشادات الأمان الهامة

يوضح رمز التحذير هذا وجود خطر. وهذا يعني أنك متواجد في مكان قد ينتج عنه التعرض لإصابات. قبل بدء العمل، احذر مخاطر التعرض للصدمات الكهربائية وكن على علم بالإجراءات القياسية للحيلولة دون وقوع أي حوادث. استخدم رقم البيان الموجود في آخر كل تحذير لتحديد مكان ترجمته داخل تحذيرات الأمان المترجمة التي تأتي مع الجهاز. قم بحفظ هذه الإرشادات

Upozorenje VAŽNE SIGURNOSNE NAPOMENE

Ovaj simbol upozorenja predstavlja opasnost. Nalazite se u situaciji koja može prouzročiti tjelesne ozljede. Prije rada s bilo kojim uređajem, morate razumjeti opasnosti vezane uz električne sklopove, te biti upoznati sa standardnim načinima izbjegavanja nesreća. U prevedenim sigurnosnim upozorenjima, priloženima uz uređaj, možete prema broju koji se nalazi uz pojedino upozorenje pronaći i njegov prijevod.

SAČUVAJTE OVE UPUTE**Upozornění DŮLEŽITÉ BEZPEČNOSTNÍ POKYNY**

Tento upozorňující symbol označuje nebezpečí. Jste v situaci, která by mohla způsobit nebezpečí úrazu. Před prací na jakémkoliv vybavení si uvědomte nebezpečí související s elektrickými obvody a seznamte se se standardními opatřeními pro předcházení úrazům. Podle čísla na konci každého upozornění vyhledejte jeho překlad v přeložených bezpečnostních upozorněních, která jsou přiložena k zařízení.

USCHOVEJTE TYTO POKYNY

Προειδοποίηση	<p>ΣΗΜΑΝΤΙΚΕΣ ΟΔΗΓΙΕΣ ΑΣΦΑΛΕΙΑΣ</p> <p>Αυτό το προειδοποιητικό σύμβολο σημαίνει κίνδυνο. Βρίσκεστε σε κατάσταση που μπορεί να προκαλέσει τραυματισμό. Πριν εργαστείτε σε οποιοδήποτε εξοπλισμό, να έχετε υπόψη σας τους κινδύνους που σχετίζονται με τα ηλεκτρικά κυκλώματα και να έχετε εξοικειωθεί με τις συνήθειες πρακτικές για την αποφυγή ατυχημάτων. Χρησιμοποιήστε τον αριθμό δήλωσης που παρέχεται στο τέλος κάθε προειδοποίησης, για να εντοπίσετε τη μετάφρασή της στις μεταφρασμένες προειδοποιήσεις ασφαλείας που συνοδεύουν τη συσκευή.</p> <p>ΦΥΛΑΞΤΕ ΑΥΤΕΣ ΤΙΣ ΟΔΗΓΙΕΣ</p>
אזהרה	<p style="text-align: right;">הוראות בטיחות חשובות</p> <p>סימן אזהרה זה מסמל סכנה. אתה נמצא במצב העלול לגרום לפציעה. לפני שתעבוד עם ציוד כלשהו, עליך להיות מודע לסכנות הכרוכות במגעלים חשמליים ולהכיר את הנהלים המקובלים למניעת תאונות. השתמש במספר ההוראה המסופק בסופה של כל אזהרה כדי לאתר את התרגום באזהרות הבטיחות המתורגמות שמצורפות להתקן.</p> <p style="text-align: right;">שמור הוראות אלה</p>
Opomena	<p>ВАЖНИ БЕЗБЕДНОСНИ НАПАТСТВИЈА</p> <p>Симболот за предупредување значи опасност. Се наоѓате во ситуација што може да предизвика телесни повреди. Пред да работите со опремата, бидете свесни за ризикот што постои кај електричните кола и треба да ги познавате стандардните постапки за спречување на несреќни случаи. Искористете го бројот на изјавата што се наоѓа на крајот на секое предупредување за да го најдете неговиот период во преведените безбедносни предупредувања што се испорачани со уредот.</p> <p>ЧУВАЈТЕ ГИ ОБИЕ НАПАТСТВИЈА</p>
Ostrzeżenie	<p>WAŻNE INSTRUKCJE DOTYCZĄCE BEZPIECZEŃSTWA</p> <p>Ten symbol ostrzeżenia oznacza niebezpieczeństwo. Zachodzi sytuacja, która może powodować obrażenia ciała. Przed przystąpieniem do prac przy urządzeniach należy zapoznać się z zagrożeniami związanymi z układami elektrycznymi oraz ze standardowymi środkami zapobiegania wypadkom. Na końcu każdego ostrzeżenia podano numer, na podstawie którego można odszukać tłumaczenie tego ostrzeżenia w dołączonym do urządzenia dokumencie z tłumaczeniami ostrzeżeń.</p> <p>NINIEJSZE INSTRUKCJE NALEŻY ZACHOWAĆ</p>
Upozornenie	<p>DÔLEŽITÉ BEZPEČNOSTNÉ POKYNY</p> <p>Tento varovný symbol označuje nebezpečenstvo. Nachádzate sa v situácii s nebezpečenstvom úrazu. Pred prácou na akomkoľvek vybavení si uvedomte nebezpečenstvo súvisiace s elektrickými obvodmi a oboznámte sa so štandardnými opatreniami na predchádzanie úrazom. Podľa čísla na konci každého upozornenia vyhľadajte jeho preklad v preložených bezpečnostných upozorneniach, ktoré sú priložené k zariadeniu.</p> <p>USCHOVAJTE SI TENTO NÁVOD</p>

Obtaining Optical Networking Information

This section contains information that is specific to optical networking products. For information that pertains to all of Cisco, refer to the [Obtaining Documentation and Submitting a Service Request](#) section.

Where to Find Safety and Warning Information

For safety and warning information, refer to the *Cisco Optical Transport Products Safety and Compliance Information* document that accompanied the product. This publication describes the international agency compliance and safety information for the Cisco ONS 15454 system. It also includes translations of the safety warnings that appear in the ONS 15454 system documentation.

Cisco Optical Networking Product Documentation CD-ROM

Optical networking-related documentation, including Cisco ONS 15xxx product documentation, is available in a CD-ROM package that ships with your product. The Optical Networking Product Documentation CD-ROM is updated periodically and may be more current than printed documentation.

Obtaining Documentation and Submitting a Service Request

For information on obtaining documentation, submitting a service request, and gathering additional information, see the monthly *What's New in Cisco Product Documentation*, which also lists all new and revised Cisco technical documentation, at:

<http://www.cisco.com/en/US/docs/general/whatsnew/whatsnew.html>

Subscribe to the *What's New in Cisco Product Documentation* as a Really Simple Syndication (RSS) feed and set content to be delivered directly to your desktop using a reader application. The RSS feeds are a free service and Cisco currently supports RSS version 2.0.



General Troubleshooting

This chapter provides procedures for troubleshooting the most common problems encountered when operating a Cisco ONS 15454. To troubleshoot specific ONS 15454 alarms, see [Chapter 2, “Alarm Troubleshooting.”](#) If you cannot find what you are looking for, contact the Cisco Technical Assistance Center (TAC) at 1 800 553-2447.

For an update on End-of-Life and End-of-Sale notices, refer to http://cisco.com/en/US/products/hw/optical/ps2006/prod_eol_notices_list.html.

This chapter includes the following sections on network problems:

- [1.1 Troubleshooting Circuit Paths with Loopbacks, page 1-2](#)—Describes loopbacks and hairpin circuits, which you can use to test circuit paths through the network or logically isolate faults.



Note

For dense wavelength division multiplexing (DWDM) network acceptance tests, refer to the *Cisco ONS 15454 DWDM Procedure Guide*.

- [1.2 Troubleshooting Electrical Circuit Paths With Loopbacks, page 1-9](#)—Explains how to use loopback tests described in “[1.1 Troubleshooting Circuit Paths with Loopbacks](#)” to isolate trouble on DS-1, DS-3, or EC-1 electrical circuits.
- [1.3 Troubleshooting DS3XM-6 or DS3XM-12 Card Electrical Paths With FEAC Loopbacks, page 1-45](#)—Describes how DS3XM-6 and DS3XM-12 card far-end alarm and control (FEAC) functions.
- [1.4 Troubleshooting Optical Circuit Paths With Loopbacks, page 1-47](#)—Explains how to use loopback tests described in “[1.1 Troubleshooting Circuit Paths with Loopbacks](#)” to isolate trouble on OC-N optical circuits.
- [1.5 Troubleshooting Ethernet Circuit Paths With Loopbacks, page 1-68](#)—Explains how to use loopback tests described in “[1.1 Troubleshooting Circuit Paths with Loopbacks](#)” to isolate trouble on G-Series or CE-Series Ethernet circuits.
- [1.6 Troubleshooting FC_MR Circuit Paths With Loopbacks, page 1-94](#)—Explains how to use loopbacks tests described in “[1.1 Troubleshooting Circuit Paths with Loopbacks](#)” to isolate trouble on Fibre Channel (FC_MR) circuits.

The remaining sections describe symptoms, problems, and solutions that are categorized according to the following topics:

- [1.7 Using CTC Diagnostics, page 1-107](#)—Explains how to perform card LED tests, download a diagnostic file for Cisco Technical Support, and create a bidirectional diagnostic VT circuit.
- [1.8 Restoring the Database and Default Settings, page 1-114](#)—Provides procedures for restoring software data and restoring the node to the default setup.

- [1.9 PC Connectivity Troubleshooting, page 1-115](#)—Provides troubleshooting procedures for PC and network connectivity to the ONS 15454.
- [1.10 CTC Operation Troubleshooting, page 1-120](#)—Provides troubleshooting procedures for Cisco Transport Controller (CTC) login or operation problems.
- [1.11 Circuits and Timing, page 1-134](#)—Provides troubleshooting procedures for circuit creation and error reporting as well as timing reference errors and alarms.
- [1.12 Fiber and Cabling, page 1-138](#)—Provides troubleshooting procedures for fiber and cabling connectivity errors.
- [1.13 Power Supply Problems, page 1-147](#)—Provides troubleshooting procedures for power supply problems.

1.1 Troubleshooting Circuit Paths with Loopbacks

Use loopbacks and hairpin circuits to test newly created SONET circuits before running live traffic or to logically locate the source of a network failure. All ONS 15454 electrical cards, OC-N cards, G-Series Ethernet cards, and FC_MR-4 cards allow loopbacks and hairpin test circuits. Other cards do not allow loopbacks, including E-Series Ethernet, ML-Series Ethernet, and DWDM cards such as Optical Booster (OPT-BST), Optical Preamplifier (OPT-PRE), Optical Service Channel and Combiner/Splitter Module (OSC-CSM), Band Optical Add/Drop Multiplexing (AD-xB-xx.x), and Channel Optical Add/Drop Multiplexing (AD-xC-xx.x) cards. For transponder (TXP) or muxponder (MXP) loopback information, refer to the *Cisco ONS 15454 DWDM Troubleshooting Guide*.

To create a loopback on a port, the port must be in the Out-of-Service and Management, Maintenance (OOS-MA,MT) service state. After you create the loopback, the service state becomes Out-of-Service and Management, Loopback and Maintenance (OOS-MA,LPBK & MT).



Caution

Facility or terminal loopbacks can be service-affecting. To protect traffic, apply a lockout or Force switch to the target loopback port. Basic directions for these procedures are in [Chapter 2, “Alarm Troubleshooting.”](#) For more information about these operations, refer to the “Maintain the Node” chapter in the *Cisco ONS 15454 Procedure Guide*.



Note

Do not use a physical loopback to verify circuit switching time or to determine whether a situation causes a traffic hit. Testing in this manner can cause a hit that exceeds 60 m/sec. To test switching times, place a test set at both physical ends of the circuit.



Caution

On all OC-N cards, a facility loopback applies to the entire card and not an individual circuit. Exercise caution when using loopbacks on an OC-N card carrying live traffic.

1.1.1 Facility Loopbacks

The following sections give general information about facility loopback operations and specific information about ONS 15454 card loopback activity.

1.1.1.1 General Behavior

A facility loopback tests the line interface unit (LIU) of a card, the electrical interface assembly (EIA), and related cabling. After applying a facility loopback on a port, use a test set to run traffic over the loopback. A successful facility loopback isolates the LIU, the EIA, or the cabling plant as the potential cause of a network problem. [Figure 1-1](#) shows a facility loopback on a DS-N electrical card.

Figure 1-1 Facility Loopback Path on a Near-End DS-N Card

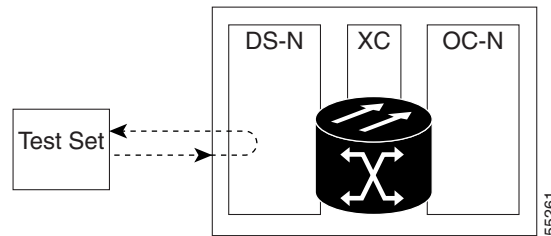

To test an OC-N card LIU, connect an optical test set to the OC-N port and perform a facility loopback. Alternately, use a loopback or hairpin circuit on a card that is farther along the circuit path. [Figure 1-2](#) shows a facility loopback on an OC-N card.

Figure 1-2 Facility Loopback Path on a Near-End OC-N Card

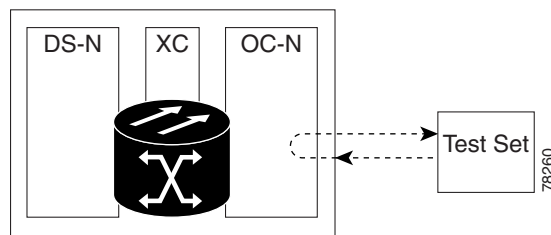

In CTC, OC-N cards with facility loopbacks show an icon ([Figure 1-3](#)). Loopback icons are not shown on other cards in this release.

Figure 1-3 OC-N Facility Loopback Indicator



Caution

Before performing a facility loopback on an OC-N card, be sure the card contains at least two data communications channel (DCC) paths to the node where the card is installed. A second DCC provides a nonlooped path to log into the node after the loopback is applied, enabling you to remove the facility loopback. Ensuring a second DCC is not necessary if you are directly connected to the ONS 15454 containing the loopback OC-N card.

Caution

Ensure that the facility being loopbacked is not line-timing the node. If it is, a timing loop will be created.

**Note**

CTC sometimes refers to facility loopbacks as facility (line) loopbacks. “Line” is meant to clarify that the loopback signal travels away from the facility where it originates and outward toward the span.

1.1.1.2 ONS 15454 Card Behavior

ONS 15454 port loopbacks either terminate or bridge the loopback signal. All ONS 15454 optical, electrical, Ethernet, and FC_MR-4 facility loopbacks are terminated as shown in [Table 1-1](#).

When a port terminates a facility loopback signal, the signal only loops back to the originating port and is not transmitted downstream. When a port bridges a loopback signal, the signal loops back to the originating port and is also transmitted downstream.

**Note**

In [Table 1-1](#), no alarm indication signal (AIS) is injected if the signal is bridged. If the signal is terminated, an applicable AIS is injected downstream for all cards except Ethernet cards.

Table 1-1 ONS 15454 Card Facility Loopback Behavior

Card/Port	Facility Loopback Signal
DS-1	Terminated
DS-3	Terminated
DS3XM-6 or DS3XM-12	Terminated
All OC-N cards	Terminated
EC-1	Terminated
G-Series Ethernet	Terminated ¹
C-Series Ethernet	Terminated ²

1. G-Series facility loopback is terminated and no AIS is sent downstream. However, the Cisco Link Integrity signal continues to be sent downstream.
2. C-Series facility loopback is terminated and no AIS is sent downstream. However, the Cisco Link Integrity signal continues to be sent downstream.

The loopback itself is listed in the Conditions window; for example, the Conditions window would list the LPBKFACILITY condition for a tested port. (The Alarms window will show AS-MT, which means that alarms are suppressed on the facility during loopback.)

The following behaviors also occur during loopback:

- If an electrical or optical port is in the Out-of-Service and Management, Disabled (OOS-MA,DSBLD) service state, the port injects an AIS signal upstream and downstream.
- When an electrical or optical port is placed in the OOS-MA,MT service state before loopback testing, the port clears the AIS signal upstream and downstream unless there is a service-affecting defect that causes an AIS signal to be injected. For more information about placing ports into alternate states for testing, refer to the “Change Card Settings” chapter in the *Cisco ONS 15454 Procedure Guide*.

FC_MR-4 card facility loopbacks behave differently from other ONS 15454 cards. With a client-side facility loopback, the client port service state is OOS-MA,LPBK & MT; however the remaining client and trunk ports can be in any other service state. For cards in a trunk-side facility loopback, the trunk port service state is OOS-MA,LPBK & MT service state and the remaining client and trunk ports can be in any other service state.



Caution

A lock out of protection must be executed before putting a two-fiber or four-fiber bidirectional line switched ring (BLSR) span into a facility loopback state. That is, a span lockout of one side (such as the east side) of a two-fiber BLSR is required before operating a facility loopback on the same (east) side of the ring. A span lockout of one protection side (such as the east protection side) of a four-fiber BLSR is required before operating a facility loopback on the same (east) side of the ring. If you do not execute the lockout prior to creating the loopback, the ring can become stuck in an anomalous state after you release the loopback.

1.1.2 Terminal Loopbacks

The following sections give general information about terminal loopback operations and specific information about ONS 15454 card loopback activity.

1.1.2.1 General Behavior

A terminal loopback tests a circuit path as it passes through the cross-connect card and loops back from the card with the loopback. [Figure 1-4](#) shows a terminal loopback on an OC-N card. The test-set traffic comes into the electrical port and travels through the cross-connect card to the optical card. The terminal loopback on the optical card turns the signal around before it reaches the LIU and sends it back through the cross-connect card to the electrical card. This test verifies that the cross-connect card and terminal circuit paths are valid, but does not test the LIU on the optical card.

Figure 1-4 Terminal Loopback Path on an OC-N Card

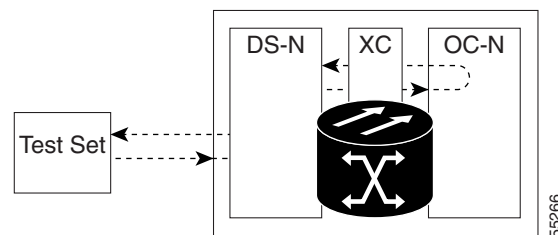

In CTC, OC-N cards with terminal loopbacks show an icon ([Figure 1-5](#)). Loopback icons are not shown on other cards in this release.

Figure 1-5 Terminal Loopback Indicator

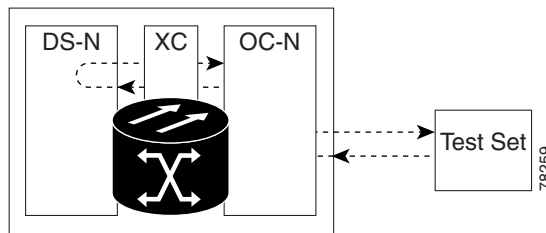

Figure 1-6 shows a terminal loopback on a DS-N electrical card. The test-set traffic comes in on the optical card and travels through the cross-connect card to the electrical card. The terminal loopback on the electrical card turns the signal around before it reaches the LIU and sends it back through the cross-connect card to the optical card. This test verifies that the cross-connect card and terminal circuit paths are valid, but does not test the LIU on the electrical card.

**Note**

CTC sometimes refers to terminal loopbacks as terminal (inward) loopbacks. “Inward” is meant to clarify that the loopback signal travels inward toward the facility where it originates and not outward toward the span.

Figure 1-6 Terminal Loopback Path on a DS-N Card



1.1.2.2 ONS 15454 Card Behavior

ONS 15454 terminal port loopbacks can either terminate or bridge the signal. In the ONS 15454 system, all optical, electrical, Ethernet, and FC_MR-4 terminal loopbacks are terminated as shown in Table 1-2. During terminal loopbacks, some ONS 15454 cards bridge the loopback signal while others terminate it.

If a port terminates a terminal loopback signal, the signal only loops back to the originating port and is not transmitted downstream. If the port bridges a loopback signal, the signal loops back to the originating port and is also transmitted downstream.

Table 1-2 lists ONS 15454 card terminal loopback bridging and terminating behaviors.

**Note**

In Table 1-2, no AIS signal is injected if the signal is bridged. If the signal is terminated, an applicable AIS is injected downstream for all cards except Ethernet cards.

Table 1-2 ONS 15454 Card Terminal Loopback Behavior

Card/Port	Terminal Loopback Signal
DS-1	Terminated
DS-3	Bridged
DS3XM-6 or DS3XM-12	Bridged
All OC-N cards	Bridged
EC-1	Bridged
G-Series Ethernet	Terminated ¹
C-Series Ethernet	Terminated ²

1. G-Series Ethernet terminal loopback is terminated and Ethernet transmission is disabled. No AIS is inserted for Ethernet, but a TPTFAIL alarm is raised on the far-end Ethernet port.
2. C-Series Ethernet terminal loopback is terminated and Ethernet transmission is disabled. No AIS is inserted for Ethernet, but a TPTFAIL alarm is raised on the far-end Ethernet port.

Bridged DS-N and OC-N terminal loopback examples are shown in [Figure 1-7](#) and [Figure 1-8](#).

Figure 1-7 Terminal Loopback on a DS-N Card with a Bridged Signal

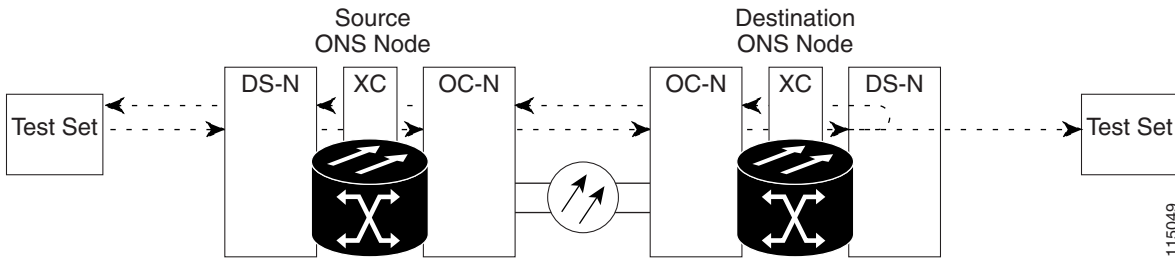

115049

Figure 1-8 Terminal Loopback on an OC-N Card with a Bridged Signal

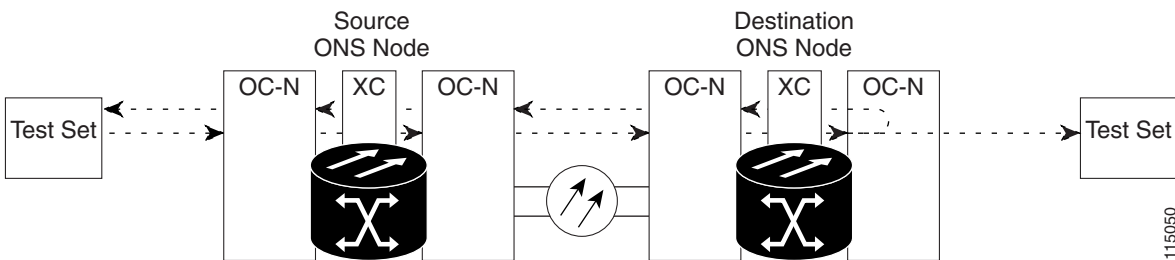

115050

G-Series Ethernet cards placed in terminal loopback have different performance monitoring behaviors from other ONS 15454 cards. (For more information about performance monitoring counters, see the “Performance Monitoring” chapter in the *Cisco ONS 15454 Reference Manual*.) Setting a terminal loopback on the G-Series Ethernet card might not stop the Tx Packets counter or the Rx Packet counters on the CTC card-level view Performance > Statistics page from increasing. The counters can increment even though the loopbacked port has temporarily disabled the transmit laser and is dropping any received packets.

The Tx Packet statistic continues to increment because the statistics are not based on packets transmitted by the transmit (Tx) laser but on the Tx signal inside the G-Series card. In normal in-service port operation, the Tx signal being recorded results in the Tx laser transmitting packets, but in a terminal loopback this signal is being looped back within the G-Series card and does not result in the Tx laser transmitting packets.

The Rx Packet counter might also continue to increment when the G-Series card is in terminal loopback. Receive (Rx) packets from any connected device are dropped and not recorded, but the internally loopbacked packets follow the G-Series card’s normal receive path and register on the Rx Packet counter.

The loopback itself is listed in the Conditions window. For example, the Conditions window would list the LPBKTERMINAL condition or the LPBKFACILITY condition for a tested port. (The Alarms window would show AS-MT, which indicates that all alarms are suppressed on the port during loopback testing.)

The following behaviors also occur during loopback:

- If an electrical or optical port is in the OOS-MA,DSBLD service state, the port injects an AIS signal upstream and downstream.

- When an electrical or optical port is placed in the OOS-MA,MT service state before loopback testing, the port clears the AIS signal upstream and downstream unless there is a service-affecting defect that also causes an AIS signal to be injected. For more information about placing ports into alternate states for testing, refer to the “Change Card Settings” chapter of the *Cisco ONS 15454 Procedure Guide*.

**Caution**

A lock out of protection must occur before putting a two-fiber or four-fiber BLSR span into a terminal loopback state. That is, a span lockout of one side (such as the east side) of a two-fiber BLSR is required before operating a facility loopback on the same (east) side of the ring. A span lockout of one protection side (such as the east protection side) of a four-fiber BLSR is required before operating a terminal loopback on the same (east) side of the ring. If you do not perform the lockout prior to creating the loopback, the ring can become stuck in an anomalous state after you release the loopback.

1.1.3 Hairpin Circuits

A hairpin circuit sends traffic in and out an electrical port rather than sending the traffic onto the OC-N card. A hairpin loops back only the specific synchronous transport signal (STS) or virtual tributary (VT) circuit and does not cause an entire OC-N port to loop back, preventing all traffic on the OC-N port from dropping. The hairpin allows you to test a specific STS or VT circuit on nodes running live traffic.

Figure 1-9 shows the hairpin circuit path on a DS-N card.

Figure 1-9 Hairpin Circuit Path on a DS-N Card

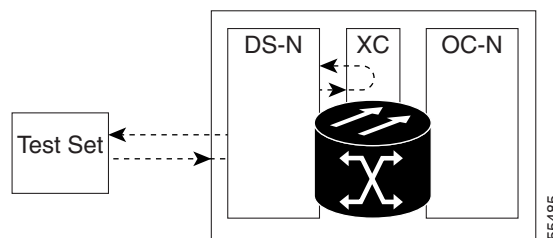

1.1.4 Cross-Connect Loopbacks

A cross-connect (XC) loopback tests an OC-N circuit path as it passes through the cross-connect card and loops back to the port being tested without affecting other traffic on the optical port. Cross-connect loopbacks are less invasive than terminal or facility loopbacks. Facility and terminal loopback testing and circuit verification often involve taking down the whole line; however, a cross-connect loopback allows you to create a loopback on any embedded channel at supported payloads of STS-1 granularity and higher. For example, you can place a loopback on a single STS-6c on an optical facility without interrupting the other STS circuits.

This test can be conducted locally or remotely through the CTC interface without on-site personnel. It takes place only on an OC-N card and tests the traffic path on that STS (or higher) circuit through the port and cross-connect card. The signal path is similar to a facility loopback.

The XC loopback breaks down the existing path and creates a new cross-connect—a hairpin—while the source of the original path is set to inject a line-side AIS-P. The loopback signal path and AIS injection are shown in Figure 1-10.

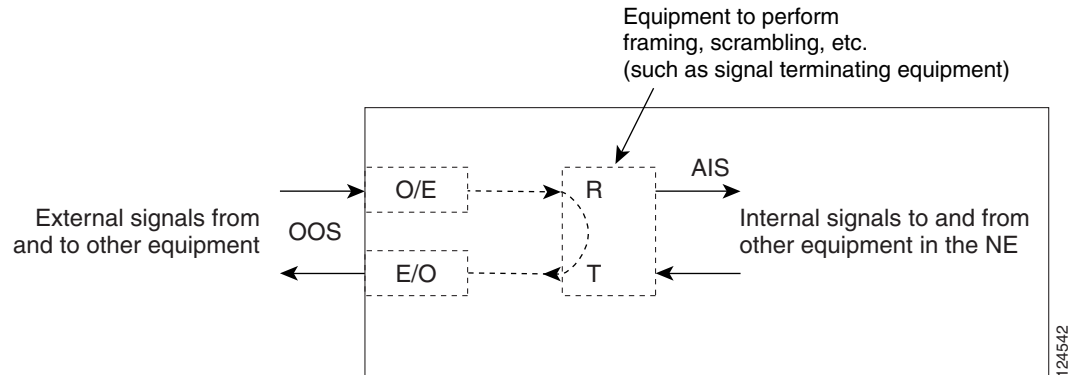
Figure 1-10 Network Element with SONET Cross-Connect Loopback Function

Consider the following rules when creating cross-connect loopbacks:

- You can create a cross-connect loopback on all working or protect optical ports unless the protect port is used in a 1+1 protection group and is in working mode.
- If a terminal or facility loopback exists on a port, you cannot use the cross-connect loopback.

1.2 Troubleshooting Electrical Circuit Paths With Loopbacks

Facility loopbacks, terminal loopbacks, and hairpin circuits are often used to test a circuit path through the network or to logically isolate a fault. Performing a loopback test at each point along the circuit path systematically isolates possible points of failure.

The example in this section tests an electrical circuit on a two-node BLSR. Using a series of facility loopbacks, terminal loopbacks, hairpins, and (where appropriate) cross-connect loopbacks on optical paths carrying electrical circuits, the path of the circuit is traced and the possible points of failure are tested and eliminated. A logical progression of eight network test procedures apply to this sample scenario:



Note

These procedures apply to DS-1, DS-3, and EC-1 cards. The test sequence for your circuits will differ according to the type of circuit and network topology.

West-to-east direction (left to right):

1. A facility loopback on the source-node electrical port (DS-N or EC-N)
2. A hairpin on the source-node electrical port
3. An XC loopback on the destination-node OC-N STS (carrying the electrical circuit)
4. A terminal loopback on the destination-node electrical port

East-to-west direction (right to left):

1. A facility loopback on the destination-node electrical port
2. A hairpin on the destination-node electrical port
3. An XC loopback on the source-node OC-N STS (carrying the electrical circuit)
4. A terminal loopback on the source-node electrical port

**Note**

Facility, hairpin, and terminal loopback tests require on-site personnel.

1.2.1 Perform a Facility Loopback on a Source Electrical Port (West to East)

The facility loopback test is performed on the node's source electrical port in the network circuit; in this example, the DS-N port in the source node. Completing a successful facility loopback on this port isolates the cabling, the electrical card, and the EIA as possible failure points. [Figure 1-11](#) shows an example of a facility loopback on a source DS-N port.

Figure 1-11 Facility Loopback on a Circuit Source DS-N Port

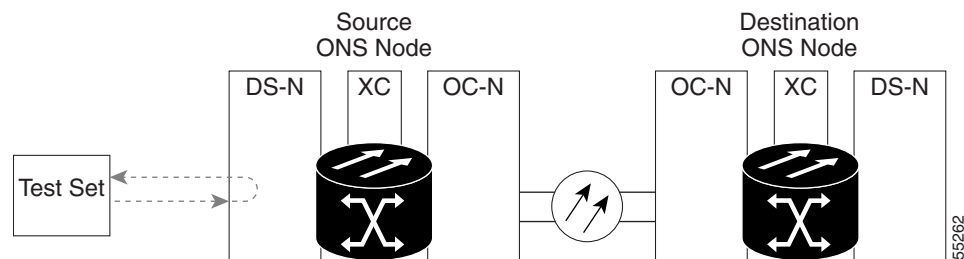
**Caution**

Performing a loopback on an in-service circuit is service-affecting. To protect traffic, apply a lockout or Force switch to the target loopback port. For more information about these operations, refer to the “Maintain the Node” chapter in the *Cisco ONS 15454 Procedure Guide*.

**Note**

Facility loopbacks require on-site personnel.

**Note**

ONS 15454 DS-3 terminal loopbacks do not transmit an AIS in the direction away from the loopback. Instead of AIS, a continuance of the signal transmitted into the loopback is provided. A DS3/EC1-48 card can be provisioned to transmit AIS for a terminal loopback if desired.

Depending on your card type, complete the [“Create the Facility Loopback on the Source DS-1, DS-3, DS3N-12, DS3i-N-12, or EC1 Port”](#) procedure on page 1-10 or the [“Create the Facility Loopback on the Source DS3E or DS3XM Port”](#) procedure on page 1-11, then test and clear the loopbacks as instructed.

Create the Facility Loopback on the Source DS-1, DS-3, DS3N-12, DS3i-N-12, or EC1 Port

- Step 1** Connect an electrical test set to the port you are testing.
Use appropriate cabling to attach the Tx and Rx terminals of the electrical test set to the EIA connectors or DSx panel for the port you are testing. The Tx and Rx terminals connect to the same port.
- Step 2** Adjust the test set accordingly. (For specific procedures to use the test set equipment, consult the manufacturer.)
- Step 3** In node view, double-click the card to open the card view.

- Step 4** Click the **Maintenance > Loopback** tabs.
- Step 5** Choose **OOS,MT** from the Admin State column for the port being tested. If this is a multiport card, select the appropriate row for the port being tested.
- Step 6** Choose **Facility** from the Loopback Type column for the port being tested. If this is a multiport card, select the appropriate row for the port being tested.
- Step 7** Click **Apply**.
- Step 8** Click **Yes** in the confirmation dialog box.



Note It is normal for the “[LPBKFACILITY \(DS1, DS3\)](#)” condition on page 2-170 to appear during loopback setup. The condition clears when you remove the loopback.

- Step 9** Complete the “[Test and Clear the DS-3, DS3N-12, DS3i-N-12, or EC1 Port Facility Loopback Circuit](#)” procedure on page 1-11.

Test and Clear the DS-3, DS3N-12, DS3i-N-12, or EC1 Port Facility Loopback Circuit

- Step 1** If the test set is not already sending traffic, send test traffic on the loopback circuit.
- Step 2** Examine the traffic received by the test set. Look for errors or any other signal information that the test set is capable of indicating.
- Step 3** If the test set indicates a good circuit, no further testing is necessary with the facility loopback. Double-click the card to open the card view.
- Step 4** Depending on the card type, click the **Maintenance > Loopback** tabs.
- Step 5** Choose **None** from the Loopback Type column for the port being tested.
- Step 6** Choose the appropriate state (**IS; OOS,DSBLD; OOS,MT; IS,AINS**) from the Admin State column for the port being tested.
- Step 7** Click **Apply**.
- Step 8** Click **Yes** in the confirmation dialog box.
- Step 9** Complete the “[Test the Electrical Cabling](#)” procedure on page 1-13.

Create the Facility Loopback on the Source DS3E or DS3XM Port

This procedure applies to DS3E, DS3XM-6, and DS3XM-12 cards. It does not use the DS3XM card FEAC loopback functions. For FEAC information, refer to the “[1.3 Troubleshooting DS3XM-6 or DS3XM-12 Card Electrical Paths With FEAC Loopbacks](#)” section on page 1-45.

- Step 1** Connect an electrical test set to the port you are testing.
Use appropriate cabling to attach the Tx and Rx terminals of the electrical test set to the EIA connectors or DSx panel for the port you are testing. The Tx and Rx terminals connect to the same port.
- Step 2** Adjust the test set accordingly. (For specific procedures to use the test set equipment, consult the manufacturer.)

1.2.1 Perform a Facility Loopback on a Source Electrical Port (West to East)

- Step 3** In node view, double-click the card to open the card view.
- Step 4** For any of these cards, click the **Maintenance > DS3** tabs.



Note The DS-3 Admin State is the basis of the DS-1 Derived State.

- Step 5** For the DS3 tab, choose **OOS,MT** from the Admin State column for the port being tested. If this is a multiport card, select the appropriate row for the port being tested. For the DS1 tab, no state selection is necessary unless the DS-1 is in service. The loopback/send code cannot be selected for a DS-1 if the derived state is OOS,DSBLD.
- Step 6** Choose **Facility** from the Loopback Type column for the port being tested. If this is a multiport card, select the appropriate row for the port being tested.
- Step 7** Click **Apply**.
- Step 8** Click **Yes** in the confirmation dialog box.



Note It is normal for the [“LPBKFACILITY \(DS1, DS3\)” condition on page 2-170](#) to appear during loopback setup. The condition clears when you remove the loopback.

- Step 9** Complete the [“Test and Clear the DS3E or DS3XM Port Facility Loopback Circuit” procedure on page 1-12](#).
-

Test and Clear the DS3E or DS3XM Port Facility Loopback Circuit

- Step 1** If the test set is not already sending traffic, send test traffic on the loopback circuit.
- Step 2** Examine the traffic received by the test set. Look for errors or any other signal information that the test set is capable of indicating.
- Step 3** If the test set indicates a good circuit, no further testing is necessary with the facility loopback. Double-click the card to open the card view.
- Step 4** For any of these cards, click the **Maintenance > DS3** tabs.



Note The DS-3 Admin State is the basis of the DS-1 Derived State.

- Step 5** Choose **None** from the Loopback Type column for the port being tested.
- Step 6** Choose the appropriate state (**IS; OOS,DSBLD; OOS,MT; IS,AINS**) from the Admin State column for the port being tested.
- Step 7** Click **Apply**.
- Step 8** Click **Yes** in the confirmation dialog box.
- Step 9** Complete the [“Test the Electrical Cabling” procedure on page 1-13](#).
-

Test the Electrical Cabling

-
- Step 1** Replace the suspected bad cabling (the cables from the test set to the DSx panel or the EIA ports) with a known-good cable. For instructions, refer to the “Install Cards and Fiber-Optic Cable” chapter in the *Cisco ONS 15454 Procedure Guide*.
- If a known-good cable is not available, test the suspected bad cable with a test set. Remove the suspected bad cable from the DSx panel or the EIA and connect the cable to the Tx and Rx terminals of the test set. Run traffic to determine whether the cable is good or defective.
- Step 2** Resend test traffic on the loopback circuit with a known-good cable installed. If the test set indicates a good circuit, the problem was probably the defective cable.
- Step 3** Replace the defective cable.
- Step 4** In card view for the electrical card, depending upon the type, click the **Maintenance > Loopback** tabs, **Maintenance > DS1** tabs, or **Maintenance > DS3** tabs.
-  **Note** The DS-3 Admin State is the basis of the DS-1 Derived State.
-
- Step 5** Choose **None** from the Loopback Type column for the port being tested.
- Step 6** Choose the appropriate state (**IS; OOS,DSBLD; OOS,MT; IS,AINS**) from the Admin State column for the port being tested.
- Step 7** Click **Apply**.
- Step 8** Click **Yes** in the confirmation dialog box.
- Step 9** Complete the “[Test the Electrical Card](#)” procedure on page 1-13.
-

Test the Electrical Card

-
- Step 1** Complete the “[Physically Replace a Traffic Card](#)” procedure on page 2-274 for the suspected bad card and replace it with a known-good one.
- Step 2** Resend test traffic on the loopback circuit with a known-good card installed.
- Step 3** If the test set indicates a good circuit, the problem was probably the defective card. Return the defective card to Cisco through the Return Materials Authorization (RMA) process. Contact Cisco Technical Support at 1 800 553-2447.
- Step 4** Complete the “[Physically Replace a Traffic Card](#)” procedure on page 2-274 for the faulty card.
- Step 5** In card view for the electrical card, depending upon the type, click the **Maintenance > Loopback** tabs, **Maintenance > DS1** tabs, or **Maintenance > DS3** tabs.
-  **Note** The DS-3 Admin State is the basis of the DS-1 Derived State.
-
- Step 6** Choose **None** from the Loopback Type column for the port being tested.
- Step 7** Choose the appropriate state (**IS; OOS,DSBLD; OOS,MT; IS,AINS**) from the Admin State column for the port being tested.
- Step 8** Click **Apply**.

- Step 9** Click **Yes** in the confirmation dialog box.
- Step 10** Complete the [“Test the EIA” procedure on page 1-14](#).

Test the EIA

- Step 1** Remove and reinstall the EIA to ensure a proper seating:
- Remove the lower backplane cover. Loosen the five screws that secure it to the ONS 15454 and pull it away from the shelf assembly.
 - Loosen the nine perimeter screws that hold the EIA panel in place.
 - Lift the EIA panel by the bottom to remove it from the shelf assembly.
 - Follow the installation procedure for the appropriate EIA. Refer to the “Install the Shelf and Backplane Cable” procedure in the *Cisco ONS 15454 Procedure Guide* for instructions.
- Step 2** Resend test traffic on the loopback circuit with known-good cabling, a known-good card, and the reinstalled EIA. If the test set indicates a good circuit, the problem was probably an improperly seated EIA, and you can proceed to [Step 16](#). If the problem persists and the EIA is not shown to be improperly seated, proceed to [Step 3](#).
- Step 3** In card view for the electrical card, depending upon the type, click the **Maintenance > Loopback** tabs, **Maintenance > DS1** tabs, or **Maintenance > DS3** tabs.



Note The DS-3 Admin State is the basis of the DS-1 Derived State.

- Step 4** Choose **None** from the Loopback Type column for the port being tested.
- Step 5** Choose the appropriate state (**IS; OOS,DSBLD; OOS,MT; IS,AINS**) from the Admin State column for the port being tested.
- Step 6** Click **Apply**.
- Step 7** Click **Yes** in the confirmation dialog box. Proceed to [Step 16](#).
- Step 8** If the test set indicates a faulty circuit, the problem is probably a defective EIA. Return the defective EIA to Cisco through the RMA process. Contact Cisco Technical Support at 1 800 553-2447.
- Step 9** Replace the faulty EIA by completing the [“Replace the Electrical Interface Assembly” procedure on page 2-282](#).
- Step 10** Resend test traffic on the loopback circuit with known-good cabling, a known-good card, and the replacement EIA. If the test set indicates a faulty circuit, repeat all of the facility loopback procedures.
- Step 11** If the test set indicates a good circuit, the problem was probably the defective EIA. Clear the facility loopback by clicking the **Maintenance > Loopback** tabs, **Maintenance > DS1** tabs, or **Maintenance > DS3** tabs.
- Step 12** Choose **None** from the Loopback Type column for the port being tested.
- Step 13** Choose the appropriate state (**IS; OOS,DSBLD; OOS,MT; IS,AINS**) from the Admin State column for the port being tested.
- Step 14** Click **Apply**.
- Step 15** Click **Yes** in the confirmation dialog box.

- Step 16** Complete the “1.2.2 Perform a Hairpin Test on a Source-Node Electrical Port (West to East)” procedure on page 1-15.

1.2.2 Perform a Hairpin Test on a Source-Node Electrical Port (West to East)

The hairpin test is performed on the cross-connect card in the network circuit. A hairpin circuit uses the same port for both source and destination. Completing a successful hairpin through the port isolates the possibility that the cross-connect card is the cause of the faulty circuit. Figure 1-12 shows an example of a hairpin loopback on a source-node port.

Figure 1-12 Hairpin on a Source-Node Port

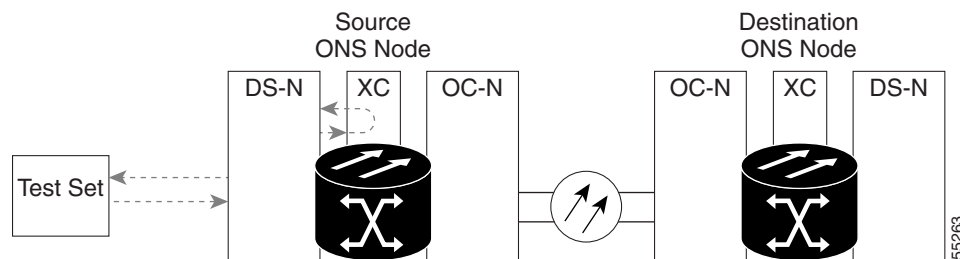

Note The ONS 15454 does not support simplex operation on the cross-connect card. Two cross-connect cards of the same type must be installed for each node.



Note Hairpin loopbacks require on-site personnel.

Complete the “Create the Hairpin Circuit on the Source-Node Electrical Port” procedure on page 1-15.

Create the Hairpin Circuit on the Source-Node Electrical Port

- Step 1** Connect an electrical test set to the port you are testing:
- If you just completed the “1.2.1 Perform a Facility Loopback on a Source Electrical Port (West to East)” procedure on page 1-10, leave the electrical test set hooked up to the electrical port in the source node.
 - If you are starting the current procedure without the electrical test set hooked up to the DS-N port, use appropriate cabling to attach the Tx and Rx terminals of the electrical test set to the DSx panel or the EIA connectors for the port you are testing. The Tx and Rx terminals connect to the same port.
- Step 2** Adjust the test set accordingly. (Refer to manufacturer instructions for test-set use.)
- Step 3** Use CTC to set up the hairpin circuit on the test port:
- In node view, click the **Circuits** tab and click **Create**.
 - In the Circuit Creation dialog box, choose the type, such as STS, and number, such as 1.
 - Click **Next**.

- d. In the next Circuit Creation dialog box, give the circuit an easily identifiable name such as Hairpin1.
 - e. Choose the Size, such as STS-1.
 - f. Uncheck the **Bidirectional** check box. Leave the default values for State, SD Threshold, and SF Threshold.
 - g. Click **Next**.
 - h. In the Circuit Creation source dialog box, select the same Node, card Slot, Port, and STS (or VT) where the test set is connected. Leave Use Secondary Source unchecked.
 - i. Click **Next**.
 - j. In the Circuit Creation destination dialog box, use the same Node, card Slot, Port, and STS (or VT) used for the source dialog box. Leave Use Secondary Destination unchecked.
 - k. Click **Next**.
 - l. In the Circuit Creation circuit routing preferences dialog box, leave all defaults. Click **Finish**.
- Step 4** Confirm that the newly created circuit appears on the Circuits tab and that the Dir column describes it as a one-way circuit.
- Step 5** Complete the [“Test and Delete the Electrical Port Hairpin Circuit” procedure on page 1-16](#).
-

Test and Delete the Electrical Port Hairpin Circuit

- Step 1** If the test set is not already sending traffic, send test traffic on the loopback circuit.
- Step 2** Examine the test traffic received by the test set. Look for errors or any other signal information that the test set is capable of indicating.
- Step 3** If the test set indicates a good circuit, no further testing is necessary with the hairpin circuit. Clear the hairpin circuit:
- a. Click the **Circuits** tab.
 - b. Choose the hairpin circuit being tested.
 - c. Click **Delete**.
 - d. Click **Yes** in the Delete Circuits dialog box. Do not check any check boxes.
 - e. Confirm that the hairpin circuit is deleted from the Circuits tab list.
- Step 4** Complete the [“Test the Standby Cross-Connect Card” procedure on page 1-16](#).
-

Test the Standby Cross-Connect Card



Note

Two cross-connect cards (active and standby) must be in use on a node to use this procedure.

- Step 1** Perform a reset on the standby cross-connect card to make it the active card:
- a. Determine the standby cross-connect card. On both the physical node and the CTC node view window, the standby cross-connect ACT/SBY LED is amber and the active card ACT/SBY LED is green.

- b. Position the cursor over the standby cross-connect card.
- c. Right-click and choose **RESET CARD**.
- d. Click **Yes** in the confirmation dialog box.

Step 2 Initiate an external switching command (side switch) on the cross-connect cards before you retest the loopback circuit:



Caution

Cross-connect side switches, with the exception of side switches using XC-VXC-10G cards, are service-affecting. Any live traffic on any card in the node endures a hit of up to 50 ms. XC-VXC-10G side switches are errorless.

- a. Determine the standby cross-connect card. On both the physical node and the CTC node view window, the standby cross-connect ACT/SBY LED is amber and the active card ACT/SBY LED is green.
- b. In the node view, select the **Maintenance > Cross-Connect > Cards** tabs.
- c. In the Cross-Connect Cards area, click **Switch**.
- d. Click **Yes** in the Confirm Switch dialog box.



Note

After the active cross-connect goes into standby mode, the original standby card becomes active and its ACT/SBY LED turns green. The former active card becomes standby and its ACT/SBY LED turns amber.

Step 3 Resend test traffic on the loopback circuit.

The test traffic now travels through the alternate cross-connect card.

Step 4 If the test set indicates a faulty circuit, assume the cross-connect card is not causing the problem. Clear the hairpin circuit:

- a. Click the **Circuits** tab.
- b. Choose the hairpin circuit being tested.
- c. Click **Delete**.
- d. Click **Yes** in the Delete Circuits dialog box. Do not check any check boxes.
- e. Confirm that the hairpin circuit is deleted from the Circuits tab list.

Step 5 To confirm a defective original cross-connect card, complete the [“Retest the Original Cross-Connect Card” procedure on page 1-17](#).

Retest the Original Cross-Connect Card

Step 1 Initiate an external switching command (side switch) on the cross-connect cards:

- a. Determine the standby cross-connect card. On both the physical node and the CTC node view window, the standby cross-connect ACT/SBY LED is amber and the active card ACT/SBY LED is green.
- b. In node view, select the **Maintenance > Cross-Connect > Cards** tabs.
- c. From the Cross-Connect Cards menu, choose **Switch**.

- d. Click **Yes** in the Confirm Switch dialog box.



Note After the active cross-connect goes into standby mode, the original standby card becomes active and its ACT/SBY LED turns green. The former active card becomes standby and its ACT/SBY LED turns amber.

- Step 2** Resend test traffic on the loopback circuit.
- Step 3** If the test set indicates a faulty circuit, the problem is probably the defective card. Return the defective card to Cisco through the RMA process. Contact Cisco Technical Support at 1 800 553-2447 and proceed to [Step 4](#). If the test does not indicate a faulty circuit, proceed to [Step 5](#).
- Step 4** Complete the “[Physically Replace an In-Service Cross-Connect Card](#)” procedure on page 2-274 for the defective card.
- Step 5** If the test set indicates a good circuit, the cross-connect card might have had a temporary problem that was cleared by the side switch. Clear the hairpin circuit:
- a. Click the **Circuits** tab.
 - b. Choose the hairpin circuit being tested.
 - c. Click **Delete**.
 - d. Click **Yes** in the Delete Circuits dialog box. Do not check any check boxes.
 - e. Confirm that the hairpin circuit is deleted from the Circuits tab list.
- Step 6** Complete the “[1.2.3 Perform an XC Loopback on a Destination-Node OC-N STS \(West to East\) Carrying an Electrical Signal](#)” procedure on page 1-18.
-

1.2.3 Perform an XC Loopback on a Destination-Node OC-N STS (West to East) Carrying an Electrical Signal

The XC loopback tests whether any problem exists on the circuit’s OC-N span, isolating this span from others present on the card. The loopback occurs on the cross-connect card in a network circuit. [Figure 1-13](#) shows an example of an XC loopback on a destination OC-N port. The traffic pattern looks similar to a terminal loopback but traffic is only carried on one STS instead of affecting the entire port.



Note The XC loopback on an OC-N card does not affect traffic on other circuits.



Note XC loopbacks do not require on-site personnel.



Note You can perform an XC loopback on either the circuit source working or the protect port of a 1+1 protection group.

Figure 1-13 XC Loopback on a Destination OC-N Port

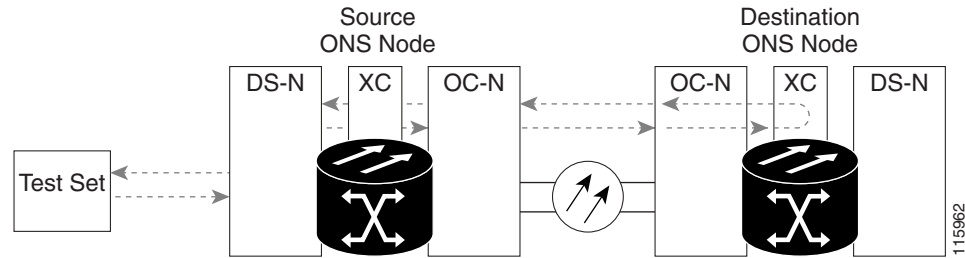

Create the XC Loopback on a Destination-Node OCN STS

Step 1 Connect an optical test set to the port you are testing:



Note For specific procedures to connect, set up, and use the test set equipment, consult the manufacturer.

- a. If you just completed the “[1.2.2 Perform a Hairpin Test on a Source-Node Electrical Port \(West to East\)](#)” procedure on page 1-15, leave the optical test set hooked up to the destination-node port.
- b. If you are starting the current procedure without the optical test set hooked up to the destination port, use appropriate cabling to attach the Tx and Rx terminals of the optical test set to the port you are testing. The Tx and Rx terminals connect to the same port.

Step 2 Adjust the test set accordingly. (Refer to manufacturer instructions for test-set use.)

Step 3 Use CTC to put the circuit being tested out of service:

- a. In node view, click the **Circuits** tab.
- b. Click the circuit and then click **Edit**.
- c. In the Edit Circuit dialog box, click the State tab.
- d. Choose **OOS,MT** from the Target Circuit Admin State drop-down list.
- e. Click **Apply**.
- f. Click **Yes** in the confirmation dialog box.

Step 4 Use CTC to set up the XC loopback on the circuit being tested:

- a. In node view, double-click the OC-N card to open the card view.
- b. Click the **Maintenance > Loopback > SONET STS** tabs.
- c. Click the check box in the **XC Loopback** column for the port being tested.
- d. Check **Apply**.
- e. Click **Yes** in the confirmation dialog box.

Step 5 Complete the “[Test and Clear the XC Loopback Circuit](#)” procedure on page 1-20.

Test and Clear the XC Loopback Circuit



Note This procedure is performed only on OC-N cards.

-
- Step 1** If the test set is not already sending traffic, send test traffic on the loopback circuit.
- Step 2** Examine the test traffic received by the test set. Look for errors or any other signal information that the test set is capable of indicating.
- Step 3** If the test set indicates a good circuit, no further testing is necessary with the cross-connect. Clear the XC loopback:
- a. In card view, click the **Maintenance > Loopback > SONET STS** tabs.
 - b. Uncheck the check box in the **XC Loopback** column for the circuit being tested.
 - c. Click **Apply**.
 - d. Click **Yes** in the confirmation dialog box.
- Step 4** Complete the [“Test the Standby Cross-Connect Card” procedure on page 1-20](#).
-

Test the Standby Cross-Connect Card

-
- Step 1** Perform a reset on the standby cross-connect card:
- a. Determine the standby cross-connect card. On both the physical node and the CTC node view window, the standby cross-connect ACT/SBY LED is amber and the active card ACT/SBY LED is green.
 - b. Position the cursor over the standby cross-connect card.
 - c. Right-click and choose **RESET CARD**.
 - d. Click **Yes** in the confirmation dialog box.
- Step 2** Initiate an external switching command (side switch) on the cross-connect cards before you retest the loopback circuit:



Caution Cross-connect side switches, with the exception of side switches using XC-VXC-10G cards, are service-affecting. Any live traffic on any card in the node endures a hit of up to 50 ms. XC-VXC-10G side switches are errorless.

-
- a. Determine the standby cross-connect card. On both the physical node and the CTC node view window, the standby cross-connect ACT/SBY LED is amber and the active card ACT/SBY LED is green.
 - b. In the node view, select the **Maintenance > Cross-Connect > Card** tabs.
 - c. In the Cross-Connect Cards area, click **Switch**.
 - d. Click **Yes** in the Confirm Switch dialog box.

**Note**

After the active cross-connect goes into standby mode, the original standby card becomes active and its ACT/SBY LED turns green. The former active card becomes standby and its ACT/SBY LED turns amber.

- Step 3** Resend test traffic on the loopback circuit.
The test traffic now travels through the alternate cross-connect card.
- Step 4** If the test set indicates a faulty circuit, assume the cross-connect card is not causing the problem. Clear the XC loopback circuit:
- Click the **Circuits** tab.
 - Choose the XC loopback circuit being tested.
 - Click **Delete**.
 - Click **Yes** in the Delete Circuits dialog box. Do not check any check boxes.
 - Confirm that the XC loopback circuit is deleted from the Circuits tab list. If the test set indicates a good circuit, the problem might be a defective cross-connect card.
- Step 5** To confirm a defective original cross-connect card, complete the [“Retest the Original Cross-Connect Card” procedure on page 1-21](#).

Retest the Original Cross-Connect Card

**Note**

This procedure is performed only on OC-N and cross-connect cards.

- Step 1** Initiate an external switching command (side switch) on the cross-connect cards.
- Determine the standby cross-connect card. On both the physical node and the CTC node view window, the standby cross-connect ACT/SBY LED is amber and the active card ACT/SBY LED is green.
 - In node view, select the **Maintenance > Cross-Connect > Card** tabs.
 - In the Cross-Connect Cards area, click **Switch**.
 - Click **Yes** in the Confirm Switch dialog box.

**Note**

After the active cross-connect goes into standby mode, the original standby card becomes active and its ACT/SBY LED turns green. The former active card becomes standby and its ACT/SBY LED turns amber.

- Step 2** Resend test traffic on the loopback circuit.
- Step 3** If the test set indicates a faulty circuit, the problem is probably the defective card. Return the defective card to Cisco through the RMA process. Contact Cisco Technical Support at 1 800 553-2447 and proceed to [Step 4](#). If the circuit is not shown to be faulty and the card is not shown to be defective, you are finished with testing.
- Step 4** Complete the [“Physically Replace an In-Service Cross-Connect Card” procedure on page 2-274](#) for the defective cross-connect card and perform [Step 5](#).

- Step 5** If the test set indicates a good circuit, the cross-connect card might have had a temporary problem that was cleared by the side switch. Clear the XC loopback circuit:
- Click the **Circuits** tab.
 - Choose the XC loopback circuit being tested.
 - Click **Delete**.
 - Click **Yes** in the Delete Circuits dialog box. Do not check any check boxes.
- Step 6** If the tests indicate further problems, go to the “1.2.4 Perform a Terminal Loopback on a Destination Electrical Port (West to East)” procedure on page 1-22.

1.2.4 Perform a Terminal Loopback on a Destination Electrical Port (West to East)

The terminal loopback test is performed on the destination-node electrical port in the circuit, such as a destination-node electrical port. You create a bidirectional circuit that starts on the source-node electrical port and loops back on the destination-node electrical port. Then you proceed with the terminal loopback test. Completing a successful terminal loopback to a destination-node electrical port verifies that the circuit is good to the destination electrical port. Figure 1-14 shows an example of a terminal loopback on a destination DS-N port.

Figure 1-14 Terminal Loopback to a Destination DS-N Port

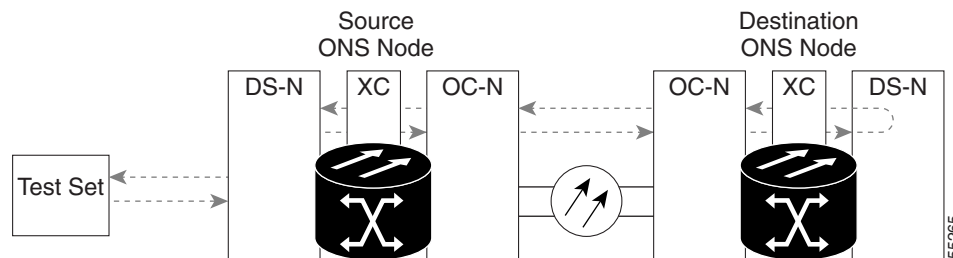

Caution

Performing a loopback on an in-service circuit is service-affecting. To protect traffic, apply a lockout or Force switch to the target loopback port. For more information about these operations, refer to the “Maintain the Node” chapter in the *Cisco ONS 15454 Procedure Guide*.



Caution

In terminal loopback mode, DS3E-12 card does not support sending AIS toward the line side while looping back traffic at the same time, though NE defaults are the same.



Note

Terminal loopbacks require on-site personnel.

**Note**

ONS 15454 DS-3 terminal loopbacks do not transmit an AIS in the direction away from the loopback. Instead of AIS, a continuance of the signal transmitted into the loopback is provided. A DS3/EC1-48 card can be provisioned to transmit AIS for a terminal loopback if desired.

Depending upon your card type, complete the [“Create the Terminal Loopback on a Destination DS-3, DS3N-12, DS3i-N-12, or EC1 Port”](#) procedure on page 1-23 or the [“Create the Terminal Loopback on a Destination DS-3E or DS3XM Port”](#) procedure on page 1-25. Then test and clear the loopback as instructed.

Create the Terminal Loopback on a Destination DS-3, DS3N-12, DS3i-N-12, or EC1 Port

- Step 1** Connect an electrical test set to the port you are testing:
- If you just completed the [“1.2.3 Perform an XC Loopback on a Destination-Node OC-N STS \(West to East\) Carrying an Electrical Signal”](#) procedure on page 1-18, leave the electrical test set hooked up to the source-node port.
 - If you are starting the current procedure without the electrical test set hooked up to the electrical port, use appropriate cabling to attach the Tx and Rx terminals of the electrical test set to the DSx panel or the EIA connectors for the port you are testing. Both Tx and Rx connect to the same port.
- Step 2** Adjust the test set accordingly. (Refer to manufacturer instructions for test-set use.)
- Step 3** In CTC node view, click the **Circuits** tab and click **Create**.
- Step 4** In the Circuit Creation dialog box, choose the type, such as STS, and number, such as 1.
- Step 5** Click **Next**
- Step 6** In the next Circuit Creation dialog box, give the circuit an easily identifiable name such as DS1toDS2.
- Step 7** Leave the **Bidirectional** check box checked.
- Step 8** Click **Next**.
- Step 9** In the Circuit Creation source dialog box, select the **Node**, card **Slot**, **Port**, and **STS (or VT)** where the test set is connected.
- Step 10** Click **Next**.
- Step 11** In the Circuit Creation destination dialog box, use the same Node, card Slot, Port, and STS (or VT) used for the source dialog box.
- Step 12** Click **Next**.
- Step 13** In the Circuit Creation circuit routing preferences dialog box, leave all defaults. Click **Finish**.
- Step 14** Confirm that the newly created circuit appears in the Dir column as a two-way circuit.

**Note**

It is normal for the [“LPBKTERMINAL \(DS1, DS3\)”](#) condition on page 2-175 to appear during a loopback setup. The condition clears when you remove the loopback.

**Note**

ONS 15454 DS-3 terminal loopbacks do not transmit an AIS in the direction away from the loopback. Instead of AIS, a continuance of the signal transmitted into the loopback is provided. A DS3/EC1-48 card can be provisioned to transmit AIS for a terminal loopback if desired.

- Step 15** Create the terminal loopback on the destination port being tested:
- a. Go to the node view of the destination node:
 - Choose **View > Go To Other Node** from the menu bar.
 - Choose the node from the drop-down list in the Select Node dialog box and click **OK**.
 - b. In node view, double-click the card that requires the loopback, such as a DS-N card in the destination node.
 - c. Click the **Maintenance > Loopback** tabs.
 - d. Select **OOS,MT** from the Admin State column. If this is a multiport card, select the row appropriate for the desired port.
 - e. Select **Terminal** from the Loopback Type column. If this is a multiport card, select the row appropriate for the desired port.
 - f. Click **Apply**.
 - g. Click **Yes** in the confirmation dialog box.
- Step 16** Complete the [“Test and Clear the DS-3, DS3N-12, DS3i-N-12, or EC1 Destination Port Terminal Loopback Circuit”](#) procedure on page 1-24.
-

Test and Clear the DS-3, DS3N-12, DS3i-N-12, or EC1 Destination Port Terminal Loopback Circuit

- Step 1** If the test set is not already sending traffic, send test traffic on the loopback circuit.
- Step 2** Examine the test traffic being received by the test set. Look for errors or any other signal information that the test set is capable of indicating.
- Step 3** If the test set indicates a good circuit, no further testing is necessary on the loopback circuit. Double-click the electrical card in the destination node with the terminal loopback.
- Step 4** Click the **Maintenance > Loopback** tabs.
- Step 5** Select **None** from the Loopback Type column for the port being tested.
- Step 6** Select the appropriate state (**IS; OOS,DSBLD; OOS,MT; IS,AINS**) in the Admin State column for the port being tested.
- Step 7** Click **Apply**.
- Step 8** Click **Yes** in the confirmation dialog box.
- Step 9** Clear the terminal loopback:
- a. Click the **Circuits** tab.
 - b. Choose the loopback circuit being tested.
 - c. Click **Delete**.
 - d. Click **Yes** in the Delete Circuits dialog box. Do not check any check boxes.
- Step 10** Complete the [“Test the Destination Electrical Card”](#) procedure on page 1-27.
-

Create the Terminal Loopback on a Destination DS-3E or DS3XM Port

-
- Step 1** Connect an electrical test set to the port you are testing:
- If you just completed the [“1.2.3 Perform an XC Loopback on a Destination-Node OC-N STS \(West to East\) Carrying an Electrical Signal” procedure on page 1-18](#), leave the electrical test set hooked up to the electrical port in the source node.
 - If you are starting the current procedure without the electrical test set hooked up to the electrical port, use appropriate cabling to attach the Tx and Rx terminals of the electrical test set to the DSx panel or the EIA connectors for the port you are testing. Both Tx and Rx connect to the same port.
 - Adjust the test set accordingly. (Refer to manufacturer instructions for test-set use.)
- Step 2** In CTC node view, click the **Circuits** tab and click **Create**.
- Step 3** In the Circuit Creation dialog box, choose the type, such as STS, and number, such as 1.
- Step 4** Click **Next**.
- Step 5** In the next Circuit Creation dialog box, give the circuit an easily identifiable name such as DS1toDS3.
- Step 6** Leave the **Bidirectional** check box checked.
- Step 7** Click **Next**.
- Step 8** In the Circuit Creation source dialog box, select the **Node**, card **Slot**, **Port**, and **STS (or VT)** where the test set is connected.
- Step 9** Click **Next**.
- Step 10** In the Circuit Creation destination dialog box, use the same Node, card Slot, Port, and STS (or VT) used for the source dialog box.
- Step 11** Click **Next**.
- Step 12** In the Circuit Creation circuit routing preferences dialog box, leave all defaults. Click **Finish**.
- Step 13** Confirm that the newly created circuit appears in the Dir column as a two-way circuit.



Note It is normal for the [“LPBKTERMINAL \(DS1, DS3\)” condition on page 2-175](#) to appear during a loopback setup. The condition clears when you remove the loopback.



Note ONS 15454 DS-3 terminal loopbacks do not transmit an AIS in the direction away from the loopback. Instead of AIS, a continuance of the signal transmitted into the loopback is provided. A DS3/EC1-48 card can be provisioned to transmit AIS for a terminal loopback if desired.

- Step 14** Create the terminal loopback on the destination port being tested:
- Go to the node view of the destination node:
 - Choose **View > Go To Other Node** from the menu bar.
 - Choose the node from the drop-down list in the Select Node dialog box and click **OK**.
 - In node view, double-click the card that requires the loopback, such as the DS-N card in the destination node.
 - Click the **Maintenance > DS3** tabs.



Note The DS-3 Admin State is the basis of the DS-1 Derived State.

- d. For the DS3 tab, choose **OOS,MT** from the Admin State column for the port being tested. If this is a multiport card, select the appropriate row for the port being tested. For the DS1 tab, no state selection is necessary unless the DS-1 is in service. The loopback/send code cannot be selected for a DS-1 if the derived state is OOS,DSBLD.
- e. Select **Terminal** from the Loopback Type column. If this is a multiport card, select the row appropriate for the desired port.
- f. Click **Apply**.
- g. Click **Yes** in the confirmation dialog box.

Step 15 Complete the [“Test and Clear the DS-3E or DS3XM Destination Port Terminal Loopback Circuit” procedure on page 1-26.](#)

Test and Clear the DS-3E or DS3XM Destination Port Terminal Loopback Circuit

- Step 1** If the test set is not already sending traffic, send test traffic on the loopback circuit.
- Step 2** Examine the test traffic being received by the test set. Look for errors or any other signal information that the test set is capable of indicating.
- Step 3** If the test set indicates a good circuit, no further testing is necessary on the loopback circuit. Double-click the electrical card in the destination node with the terminal loopback.
- Step 4** Click the **Maintenance > DS3** tabs.



Note The DS-3 Admin State is the basis of the DS-1 Derived State.

- Step 5** Select **None** from the Loopback Type column for the port being tested.
 - Step 6** Select the appropriate state (**IS; OOS,DSBLD; OOS,MT; IS,AINS**) in the Admin State column for the port being tested.
 - Step 7** Click **Apply**.
 - Step 8** Click **Yes** in the confirmation dialog box.
 - Step 9** Clear the terminal loopback:
 - a. Click the **Circuits** tab.
 - b. Choose the loopback circuit being tested.
 - c. Click **Delete**.
 - d. Click **Yes** in the Delete Circuits dialog box. Do not check any check boxes.
 - Step 10** Complete the [“Test the Destination Electrical Card” procedure on page 1-27.](#)
-

Test the Destination Electrical Card

-
- Step 1** Complete the “[Physically Replace a Traffic Card](#)” procedure on page 2-274 for the suspected bad card and replace it with a known-good one.
- Step 2** Resend test traffic on the loopback circuit with a known-good card.
- Step 3** If the test set indicates a good circuit, the problem was probably the defective card. Return the defective card to Cisco through the RMA process. Contact Cisco Technical Support at 1 800 553-2447.
- Step 4** Complete the “[Physically Replace a Traffic Card](#)” procedure on page 2-274 for the defective electrical card.
- Step 5** Clear the terminal loopback state on the port:
- Double-click the electrical card in the destination node with the terminal loopback.
 - Depending upon the card type, click the **Maintenance > Loopback** tabs, **Maintenance > DS1** tabs, or **Maintenance > DS3** tabs.
-  **Note** The DS-3 Admin State is the basis of the DS-1 Derived State.
- Select **None** from the Loopback Type column for the port being tested.
 - Select the appropriate state (**IS; OOS,DSBLD; OOS,MT; IS,AINS**) in the Admin State column for the port being tested.
 - Click **Apply**.
 - Click **Yes** in the confirmation dialog box.
- Step 6** Delete the terminal loopback circuit:
- Click the **Circuits** tab.
 - Choose the loopback circuit being tested.
 - Click **Delete**.
 - Click **Yes** in the Delete Circuits dialog box. Do not check any check boxes.
- Step 7** Complete the “[1.2.5 Perform a Facility Loopback on a Destination-Node Electrical Port \(East to West\)](#)” procedure on page 1-27.
-

1.2.5 Perform a Facility Loopback on a Destination-Node Electrical Port (East to West)

The facility loopback test is performed on the destination-node electrical port in the network circuit. Completing a successful facility loopback on this port isolates the cabling, the electrical card, and the EIA as possible failure points. [Figure 1-15](#) shows an example of a facility loopback on a destination DS-N port.

Figure 1-15 Facility Loopback on a Circuit Destination DS-N Port

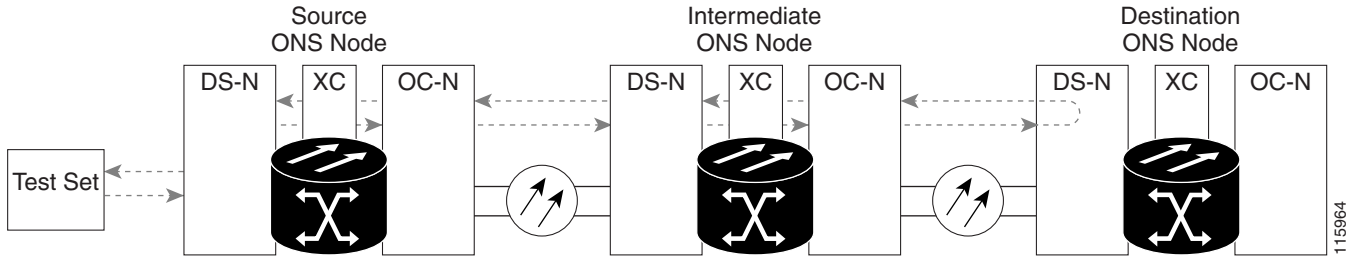

Caution

Performing a loopback on an in-service circuit is service-affecting. To protect traffic, apply a lockout or Force switch to the target loopback port. For basic instructions, refer to the “[2.9.2 Protection Switching, Lock Initiation, and Clearing](#)” section on page 2-262. For more information about these operations, refer to the “Maintain the Node” chapter in the *Cisco ONS 15454 Procedure Guide*.



Note

Facility loopbacks require on-site personnel.



Note

ONS 15454 DS-3 terminal loopbacks do not transmit an AIS in the direction away from the loopback. Instead of AIS, a continuance of the signal transmitted into the loopback is provided. A DS3/EC1-48 card can be provisioned to transmit AIS for a terminal loopback if desired.

Depending on your card type, complete the “[Create the Facility Loopback on the Destination DS-1, DS-3, DS3N-12, DS3i-N-12, or EC-1 Port](#)” procedure on page 1-28 or the “[Create the Facility Loopback on the Source DS3E or DS3XM Port](#)” procedure on page 1-29. Then test and clear the loopback as instructed.

Create the Facility Loopback on the Destination DS-1, DS-3, DS3N-12, DS3i-N-12, or EC-1 Port

- Step 1** Connect an electrical test set to the port you are testing:
- If you just completed the “[1.2.4 Perform a Terminal Loopback on a Destination Electrical Port \(West to East\)](#)” procedure on page 1-22, leave the electrical test set hooked up to the destination-node port.
 - Use appropriate cabling to attach the Tx and Rx terminals of the electrical test set to the EIA connectors or DSx panel for the port you are testing. The Tx and Rx terminals connect to the same port.
- Step 2** Adjust the test set accordingly. (Refer to manufacturer instructions for test-set use.)
- Step 3** In CTC node view, double-click the card to open the card view.
- Step 4** Click the **Maintenance > Loopback** tabs.
- Step 5** Choose **OOS,MT** from the Admin State column for the port being tested. If this is a multiport card, select the appropriate row for the port being tested.
- Step 6** Choose **Facility** from the Loopback Type column for the port being tested. If this is a multiport card, select the appropriate row for the port being tested.

Step 7 Click **Apply**.

Step 8 Click **Yes** in the confirmation dialog box.



Note It is normal for a [“LPBKFACILITY \(DS1, DS3\)” condition on page 2-170](#) to appear during loopback setup. The condition clears when you remove the loopback.

Step 9 Complete the [“Test and Clear the DS-3, DS3N-12, DS3i-N-12, or EC-1 Port Facility Loopback Circuit” procedure on page 1-29](#).

Test and Clear the DS-3, DS3N-12, DS3i-N-12, or EC-1 Port Facility Loopback Circuit

Step 1 If the test set is not already sending traffic, send test traffic on the loopback circuit.

Step 2 Examine the traffic received by the test set. Look for errors or any other signal information that the test set is capable of indicating.

Step 3 If the test set indicates a good circuit, no further testing is necessary with the facility loopback. Double-click the card to open the card view.

Step 4 Click the **Maintenance > Loopback** tabs.

Step 5 Choose **None** from the Loopback Type column for the port being tested.

Step 6 Choose the appropriate state (**IS; OOS,DSBLD; OOS,MT; IS,AINS**) from the Admin State column for the port being tested.

Step 7 Click **Apply**.

Step 8 Click **Yes** in the confirmation dialog box.

Step 9 Complete the [“Test the Electrical Cabling” procedure on page 1-30](#).

Create the Facility Loopback on the Source DS3E or DS3XM Port

This procedure applies to DS3E, DS3XM-6, and DS3XM-12 cards. It does not utilize the DS3XM card FEAC loopback functions. For FEAC information, refer to the [“1.3 Troubleshooting DS3XM-6 or DS3XM-12 Card Electrical Paths With FEAC Loopbacks” section on page 1-45](#).

Step 1 Connect an electrical test set to the port you are testing.

Use appropriate cabling to attach the Tx and Rx terminals of the electrical test set to the EIA connectors or DSx panel for the port you are testing. The Tx and Rx terminals connect to the same port. Adjust the test set accordingly. (Refer to manufacturer instructions for test-set use.)

Step 2 In CTC node view, double-click the card to open the card view.

Step 3 For any of these cards, click the **Maintenance > DS3** tabs.



Note The DS-3 Admin State is the basis of the DS-1 Derived State.

1.2.5 Perform a Facility Loopback on a Destination-Node Electrical Port (East to West)

- Step 4** For the DS3 tab, choose **OOS,MT** from the Admin State column for the port being tested. If this is a multiport card, select the appropriate row for the port being tested. For the DS1 tab, no state selection is necessary unless the DS-1 is in service. The loopback/send code cannot be selected for a DS-1 if the derived state is OOS,DSBLD.
- Step 5** Choose **Facility** from the Loopback Type column for the port being tested. If this is a multiport card, select the appropriate row for the port being tested.
- Step 6** Click **Apply**.
- Step 7** Click **Yes** in the confirmation dialog box.



Note It is normal for the [“LPBKFACILITY \(DS1, DS3\)” condition on page 2-170](#) to appear during loopback setup. The condition clears when you remove the loopback.

- Step 8** Complete the [“Test and Clear the DS3E or DS3XM Port Facility Loopback Circuit” procedure on page 1-30](#).

Test and Clear the DS3E or DS3XM Port Facility Loopback Circuit

- Step 1** If the test set is not already sending traffic, send test traffic on the loopback circuit.
- Step 2** Examine the traffic received by the test set. Look for errors or any other signal information that the test set is capable of indicating.
- Step 3** If the test set indicates a good circuit, no further testing is necessary with the facility loopback. Double-click the card to open the card view.
- Step 4** For any of these cards, click the **Maintenance > DS3** tabs.



Note The DS-3 Admin State is the basis of the DS-1 Derived State.

- Step 5** Choose **None** from the Loopback Type column for the port being tested.
- Step 6** Choose the appropriate state (**IS; OOS,DSBLD; OOS,MT; IS,AINS**) from the Admin State column for the port being tested.
- Step 7** Click **Apply**.
- Step 8** Click **Yes** in the confirmation dialog box.
- Step 9** Complete the [“Test the Electrical Cabling” procedure on page 1-30](#).

Test the Electrical Cabling

- Step 1** Replace the suspected bad cabling (from the test set to the DSx panel or the EIA ports) with known-good cable. For instructions, refer to the [“Install Cards and Fiber-Optic Cable” chapter in the Cisco ONS 15454 Procedure Guide](#).

If a known-good cable is not available, test the suspected bad cable with a test set. (Refer to manufacturer instructions for test-set use.) Remove the suspected bad cable from the DSx panel or the EIA and connect the cable to the Tx and Rx terminals of the test set. Run traffic to determine whether the cable is good or defective.

- Step 2** Resend test traffic on the loopback circuit with a known-good cable installed. If the test set indicates a good circuit, the problem was probably the defective cable.
- Step 3** Replace the defective cable.
- Step 4** In card view for the electrical card, depending upon the type, click the **Maintenance > Loopback** tabs, **Maintenance > DS1** tabs, or **Maintenance > DS3** tabs.



Note The DS-3 Admin State is the basis of the DS-1 Derived State.

- Step 5** Choose **None** from the Loopback Type column for the port being tested.
 - Step 6** Choose the appropriate state (**IS; OOS,DSBLD; OOS,MT; IS,AINS**) from the Admin State column for the port being tested.
 - Step 7** Click **Apply**.
 - Step 8** Click **Yes** in the confirmation dialog box.
 - Step 9** Complete the [“Test the Electrical Card” procedure on page 1-31](#).
-

Test the Electrical Card

- Step 1** Complete the [“Physically Replace a Traffic Card” procedure on page 2-274](#) for the suspected bad card and replace it with a known-good one.
- Step 2** Resend test traffic on the loopback circuit with a known-good card installed.
- Step 3** If the test set indicates a good circuit, the problem was probably the defective card. Return the defective card to Cisco through the RMA process. Contact Cisco Technical Support at 1 800 553-2447.
- Step 4** Complete the [“Physically Replace a Traffic Card” procedure on page 2-274](#) for the faulty card.
- Step 5** In card view for the electrical card, depending upon the type, click the **Maintenance > Loopback** tabs, **Maintenance > DS1** tabs, or **Maintenance > DS3** tabs.



Note The DS-3 Admin State is the basis of the DS-1 Derived State.

- Step 6** Choose **None** from the Loopback Type column for the port being tested.
 - Step 7** Choose the appropriate state (**IS; OOS,DSBLD; OOS,MT; IS,AINS**) from the Admin State column for the port being tested.
 - Step 8** Click **Apply**.
 - Step 9** Click **Yes** in the confirmation dialog box.
 - Step 10** Complete the [“Test the EIA” procedure on page 1-32](#).
-

Test the EIA

-
- Step 1** Remove and reinstall the EIA to ensure a proper seating:
- Remove the lower backplane cover. Loosen the five screws that secure it to the ONS 15454 and pull it away from the shelf assembly.
 - Loosen the nine perimeter screws that hold the EIA panel in place.
 - Lift the EIA panel by the bottom to remove it from the shelf assembly.
 - Follow the installation procedure for the appropriate EIA. Refer to the “Install the Shelf and Backplane Cable” chapter in the *Cisco ONS 15454 Procedure Guide* for instructions.
- Step 2** Resend test traffic on the loopback circuit with known-good cabling, a known-good card, and the reinstalled EIA. If the test set indicates a good circuit, the problem was probably an improperly seated EIA, and you can proceed to [Step 16](#). If the problem persists and the EIA is not shown to be improperly seated, proceed to [Step 3](#).
- Step 3** In card view for the electrical card, depending upon the type, click the **Maintenance > Loopback** tabs, **Maintenance > DS1** tabs, or **Maintenance > DS3** tabs.



Note The DS-3 Admin State is the basis of the DS-1 Derived State.

- Step 4** Choose **None** from the Loopback Type column for the port being tested.
- Step 5** Choose the appropriate state (**IS; OOS,DSBLD; OOS,MT; IS,AINS**) from the Admin State column for the port being tested.
- Step 6** Click **Apply**.
- Step 7** Click **Yes** in the confirmation dialog box.
- Step 8** If the test set indicates a faulty circuit, the problem is probably a defective EIA. Return the defective EIA to Cisco through the RMA process. Contact Cisco Technical Support at 1 800 553-2447.
- Step 9** Replace the faulty EIA. Complete the “[Replace the Electrical Interface Assembly](#)” procedure on [page 2-282](#).
- Step 10** Resend test traffic on the loopback circuit with known-good cabling, a known-good card, and the replacement EIA. If the test set indicates a faulty circuit, repeat all of the facility loopback procedures.
- Step 11** If the test set indicates a good circuit, the problem was probably the defective EIA. Clear the facility loopback by clicking the **Maintenance > Loopback** tabs, **Maintenance > DS1** tabs, or **Maintenance > DS3** tabs.
- Step 12** Choose **None** from the Loopback Type column for the port being tested.
- Step 13** Choose the appropriate state (**IS; OOS,DSBLD; OOS,MT; IS,AINS**) from the Admin State column for the port being tested.
- Step 14** Click **Apply**.
- Step 15** Click **Yes** in the confirmation dialog box.
- Step 16** Complete the “[1.2.6 Perform a Hairpin Test on a Destination-Node Electrical Port \(East to West\)](#)” procedure on [page 1-33](#).
-

1.2.6 Perform a Hairpin Test on a Destination-Node Electrical Port (East to West)

The hairpin test is performed on the cross-connect card in the network circuit and uses the same port as source as well as destination. Completing a successful hairpin through the card isolates the possibility that the cross-connect card is the cause of the faulty circuit. [Figure 1-16](#) shows an example of a hairpin loopback on a destination-node port.

Figure 1-16 Hairpin on a Destination-Node DS-N Port

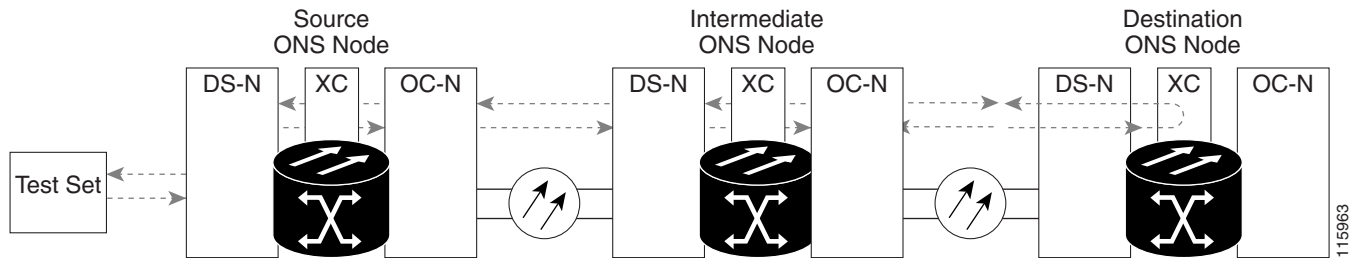

Note The ONS 15454 does not support simplex operation on the cross-connect card. Two cross-connect cards of the same type must be installed for each node.



Note Hairpin loopbacks require on-site personnel.

Complete the “[Create the Hairpin Circuit on the Destination-Node Port](#)” procedure on [page 1-33](#).

Create the Hairpin Circuit on the Destination-Node Port

- Step 1** Connect an electrical test set to the port you are testing:
- If you just completed the “[1.2.5 Perform a Facility Loopback on a Destination-Node Electrical Port \(East to West\)](#)” procedure on [page 1-27](#), leave the electrical test set hooked up to the electrical port in the destination node.
 - If you are starting the current procedure without the electrical test set hooked up to the electrical port, use appropriate cabling to attach the Tx and Rx terminals of the electrical test set to the DSx panel or the EIA connectors for the port you are testing. The Tx and Rx terminals connect to the same port.
- Step 2** Adjust the test set accordingly. (Refer to manufacturer instructions for test-set use.)
- Step 3** Use CTC to set up the hairpin circuit on the test port:
- In node view, click the **Circuits** tab and click **Create**.
 - In the Circuit Creation dialog box, choose the type, such as STS, and number, such as 1.
 - Click **Next**.
 - In the next Circuit Creation dialog box, give the circuit an easily identifiable name such as Hairpin1.
 - Choose the Size, such as STS-1.

- f. Uncheck the **Bidirectional** check box. Leave the default values for State, SD Threshold, and SF Threshold.
 - g. Click **Next**.
 - h. In the Circuit Creation source dialog box, select the same Node, card Slot, Port, and STS (or VT) where the test set is connected. Leave Use Secondary Source unchecked.
 - i. Click **Next**.
 - j. In the Circuit Creation destination dialog box, use the same Node, card Slot, Port, and STS (or VT) used for the source dialog box. Leave Use Secondary Destination unchecked.
 - k. Click **Next**.
 - l. In the Circuit Creation circuit routing preferences dialog box, leave all defaults. Click **Finish**.
- Step 4** Confirm that the newly created circuit appears on the Circuits tab and that the Dir column describes it as a one-way circuit.
- Step 5** Complete the [“Test and Delete the Electrical Hairpin Circuit” procedure on page 1-34](#).
-

Test and Delete the Electrical Hairpin Circuit

- Step 1** If the test set is not already sending traffic, send test traffic on the loopback circuit.
- Step 2** Examine the test traffic received by the test set. Look for errors or any other signal information that the test set is capable of indicating.
- Step 3** If the test set indicates a good circuit, no further testing is necessary with the hairpin circuit. Clear the hairpin circuit:
- a. Click the **Circuits** tab.
 - b. Choose the hairpin circuit being tested.
 - c. Click **Delete**.
 - d. Click **Yes** in the Delete Circuits dialog box. Do not check any check boxes.
 - e. Confirm that the hairpin circuit is deleted from the Circuits tab list.
- Step 4** Complete the [“Test the Standby Cross-Connect Card” procedure on page 1-34](#).
-

Test the Standby Cross-Connect Card



Note

Two cross-connect cards (active and standby) must be in use on a node to use this procedure.

- Step 1** Perform a reset on the standby cross-connect card to make it the active card:
- a. Determine the standby cross-connect card. On both the physical node and the CTC node view window, the standby cross-connect ACT/SBY LED is amber and the active card ACT/SBY LED is green.
 - b. Position the cursor over the standby cross-connect card.
 - c. Right-click and choose **RESET CARD**.

- d. Click **Yes** in the confirmation dialog box.

Step 2 Initiate an external switching command (side switch) on the cross-connect cards before you retest the loopback circuit:

**Caution**

Cross-connect side switches, with the exception of side switches using XC-VXC-10G cards, are service-affecting. Any live traffic on any card in the node endures a hit of up to 50 ms. XC-VXC-10G side switches are errorless.

- a. Determine the standby cross-connect card. On both the physical node and the CTC node view window, the standby cross-connect ACT/SBY LED is amber and the active card ACT/SBY LED is green.
- b. In the node view, select the **Maintenance > Cross-Connect > Cards** tabs.
- c. In the Cross-Connect Cards area, click **Switch**.
- d. Click **Yes** in the Confirm Switch dialog box.

**Note**

After the active cross-connect goes into standby mode, the original standby card becomes active and its ACT/SBY LED turns green. The former active card becomes standby and its ACT/SBY LED turns amber.

Step 3 Resend test traffic on the loopback circuit.

The test traffic now travels through the alternate cross-connect card.

Step 4 If the test set indicates a faulty circuit, assume the cross-connect card is not causing the problem. Clear the hairpin circuit:

- a. Click the **Circuits** tab.
- b. Choose the hairpin circuit being tested.
- c. Click **Delete**.
- d. Click **Yes** in the Delete Circuits dialog box. Do not check any check boxes.
- e. Confirm that the hairpin circuit is deleted from the Circuits tab list.

Step 5 To confirm a defective original cross-connect card, complete the [“Retest the Original Cross-Connect Card” procedure on page 1-35](#).

Retest the Original Cross-Connect Card

Step 1 Initiate an external switching command (side switch) on the cross-connect cards:

- a. Determine the standby cross-connect card. On both the physical node and the CTC node view window, the standby cross-connect ACT/SBY LED is amber and the active card ACT/SBY LED is green.
- b. In node view, select the **Maintenance > Cross-Connect > Cards** tabs.
- c. From the Cross-Connect Cards menu, choose **Switch**.
- d. Click **Yes** in the Confirm Switch dialog box.



Note After the active cross-connect goes into standby mode, the original standby card becomes active and its ACT/SBY LED turns green. The former active card becomes standby and its ACT/SBY LED turns amber.

- Step 2** Resend test traffic on the loopback circuit.
- Step 3** If the test set indicates a faulty circuit, the problem is probably the defective card. Return the defective card to Cisco through the RMA process. Contact Cisco Technical Support at 1 800 553-2447 and proceed to [Step 4](#). If the test does not indicate a faulty circuit, proceed to [Step 5](#).
- Step 4** Complete the “[Physically Replace an In-Service Cross-Connect Card](#)” procedure on page 2-274 for the defective cross-connect card.
- Step 5** If the test set indicates a good circuit, the cross-connect card might have had a temporary problem that was cleared by the side switch. Clear the hairpin circuit:
- Click the **Circuits** tab.
 - Choose the hairpin circuit being tested.
 - Click **Delete**.
 - Click **Yes** in the Delete Circuits dialog box. Do not check any check boxes.
 - Confirm that the hairpin circuit is deleted from the Circuits tab list.
- Step 6** Complete the “[1.2.7 Perform an XC Loopback on a Source-Node OC-N STS \(East to West\) Carrying an Electrical Circuit](#)” procedure on page 1-36.
-

1.2.7 Perform an XC Loopback on a Source-Node OC-N STS (East to West) Carrying an Electrical Circuit

The XC loopback tests whether problem exists on the circuit’s OC-N span by isolating this span from others on the card. The loopback also eliminates the cross-connect card as the source of trouble for a faulty circuit. The loopback occurs on the cross-connect card in a network circuit. [Figure 1-17](#) shows an example of an XC loopback on a source OC-N port.



Note The XC loopback on an OC-N card does not affect traffic on other circuits.



Note XC loopbacks do not require on-site personnel.



Note You can perform an XC loopback on either the circuit source working port or the protect port of a 1+1 protection group.

Figure 1-17 XC Loopback on a Source OC-N Port

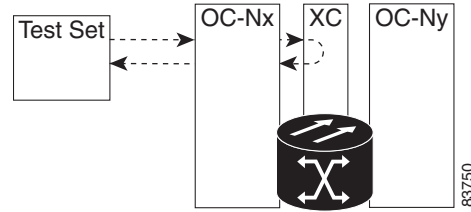

Complete the “[Create the XC Loopback on the Source OC-N Port Carrying an Electrical Circuit](#)” procedure on page 1-37.

Create the XC Loopback on the Source OC-N Port Carrying an Electrical Circuit

Step 1 Connect an optical test set to the port you are testing:



Note For specific procedures to connect, set up, and use the test set equipment, consult the manufacturer.

- a. If you just completed the “[1.2.6 Perform a Hairpin Test on a Destination-Node Electrical Port \(East to West\)](#)” procedure on page 1-33, leave the optical test set hooked up to the source-node port.
- b. If you are starting the current procedure without the optical test set hooked up to the source port, use appropriate cabling to attach the Tx and Rx terminals of the optical test set to the port you are testing. The Tx and Rx terminals connect to the same port.

Step 2 Adjust the test set accordingly. (Refer to manufacturer instructions for test-set use.)

Step 3 Use CTC to put the circuit being tested out of service:

- a. In node view, click the **Circuits** tab.
- b. Click the circuit and then click **Edit**.
- c. In the Edit Circuit dialog box, click the State tab.
- d. Choose **OOS,MT** from the Target Circuit Admin State drop-down list.
- e. Click **Apply**.
- f. Click **Yes** in the confirmation dialog box.

Step 4 Use CTC to set up the XC loopback on the circuit being tested:

- a. In node view, double-click the OC-N card to open the card view.
- b. Click the **Maintenance > Loopback > SONET STS** tabs.
- c. Check the **XC Loopback** column check box for the port being tested.
- d. Click **Apply**.
- e. Click **Yes** in the confirmation dialog box.

Step 5 Complete the “[Test and Clear the XC Loopback Circuit](#)” procedure on page 1-38.

Test and Clear the XC Loopback Circuit



Note This procedure is performed only on OC-N cards.

-
- Step 1** If the test set is not already sending traffic, send test traffic on the loopback circuit.
- Step 2** Examine the test traffic received by the test set. Look for errors or any other signal information that the test set is capable of indicating.
- Step 3** If the test set indicates a good circuit, no further testing is necessary with the cross-connect. Clear the XC loopback:
- In card view, click the **Maintenance > Loopback > SONET STS** tabs.
 - Uncheck the check box in the **XC Loopback** column for the circuit being tested.
 - Click **Apply**.
 - Click **Yes** in the confirmation dialog box.
- Step 4** Complete the [“Test the Standby Cross-Connect Card” procedure on page 1-38](#).
-

Test the Standby Cross-Connect Card

-
- Step 1** Perform a reset on the standby cross-connect card:
- Determine the standby cross-connect card. On both the physical node and the CTC node view window, the standby cross-connect ACT/SBY LED is amber and the active card ACT/SBY LED is green.
 - Position the cursor over the standby cross-connect card.
 - Right-click and choose **RESET CARD**.
 - Click **Yes** in the confirmation dialog box.
- Step 2** Initiate an external switching command (side switch) on the cross-connect cards before you retest the loopback circuit:



Caution Cross-connect side switches, with the exception of side switches using XC-VXC-10G cards, are service-affecting. Any live traffic on any card in the node endures a hit of up to 50 ms. XC-VXC-10G side switches are errorless.

-
- Determine the standby cross-connect card. On both the physical node and the CTC node view window, the standby cross-connect ACT/SBY LED is amber and the active card ACT/SBY LED is green.
 - In the node view, select the **Maintenance > Cross-Connect > Cards** tabs.
 - In the Cross-Connect Cards area, click **Switch**.
 - Click **Yes** in the Confirm Switch dialog box.

**Note**

After the active cross-connect goes into standby mode, the original standby card becomes active and its ACT/SBY LED turns green. The former active card becomes standby and its ACT/SBY LED turns amber.

- Step 3** Resend test traffic on the loopback circuit.
The test traffic now travels through the alternate cross-connect card.
- Step 4** If the test set indicates a faulty circuit, assume the cross-connect card is not causing the problem. Clear the XC loopback circuit:
- Click the **Circuits** tab.
 - Choose the XC loopback circuit being tested.
 - Click **Delete**.
 - Click **Yes** in the Delete Circuits dialog box. Do not check any check boxes.
 - Confirm that the XC loopback circuit is deleted from the Circuits tab list. If the test set indicates a good circuit, the problem might be a defective cross-connect card.
- Step 5** To confirm a defective original cross-connect card, complete the [“Retest the Original Cross-Connect Card” procedure on page 1-39](#).

Retest the Original Cross-Connect Card

**Note**

This procedure is performed only on OC-N and cross-connect cards.

- Step 1** Initiate an external switching command (side switch) on the cross-connect cards.
- Determine the standby cross-connect card. On both the physical node and the CTC node view window, the standby cross-connect ACT/SBY LED is amber and the active card ACT/SBY LED is green.
 - In node view, select the **Maintenance > Cross-Connect > Cards** tabs.
 - In the Cross-Connect Cards area, click **Switch**.
 - Click **Yes** in the Confirm Switch dialog box.

**Note**

After the active cross-connect goes into standby mode, the original standby card becomes active and its ACT/SBY LED turns green. The former active card becomes standby and its ACT/SBY LED turns amber.

- Step 2** Resend test traffic on the loopback circuit.
- Step 3** If the test set indicates a faulty circuit, the problem is probably the defective card. Return the defective card to Cisco through the RMA process. Contact Cisco Technical Support at 1 800 553-2447 and proceed to [Step 4](#). If the circuit is not shown to be faulty and the card is not shown to be defective, you are finished with testing.
- Step 4** Complete the [“Physically Replace an In-Service Cross-Connect Card” procedure on page 2-274](#) for the defective cross-connect card. Perform [Step 5](#).

- Step 5** If the test set indicates a good circuit, the cross-connect card might have had a temporary problem that was cleared by the side switch. Clear the XC loopback circuit:
- Click the **Circuits** tab.
 - Choose the XC loopback circuit being tested.
 - Click **Delete**.
 - Click **Yes** in the Delete Circuits dialog box. Do not check any check boxes.
 - If the problem is not resolved, go to the “1.2.8 Perform a Terminal Loopback on a Source-Node Electrical Port (East to West)” section on page 1-40.

1.2.8 Perform a Terminal Loopback on a Source-Node Electrical Port (East to West)

The terminal loopback test is performed on the source-node electrical port in the circuit, such as a source-node electrical port. You first create a bidirectional circuit that starts on the destination-node electrical port and loops back on the source-node electrical port. Then you proceed with the terminal loopback test. Completing a successful terminal loopback to a source-node electrical port verifies that the circuit is good to the source electrical port. [Figure 1-18](#) shows an example of a terminal loopback on a source DS-N port.

Figure 1-18 Terminal Loopback on a Source DS-N Port

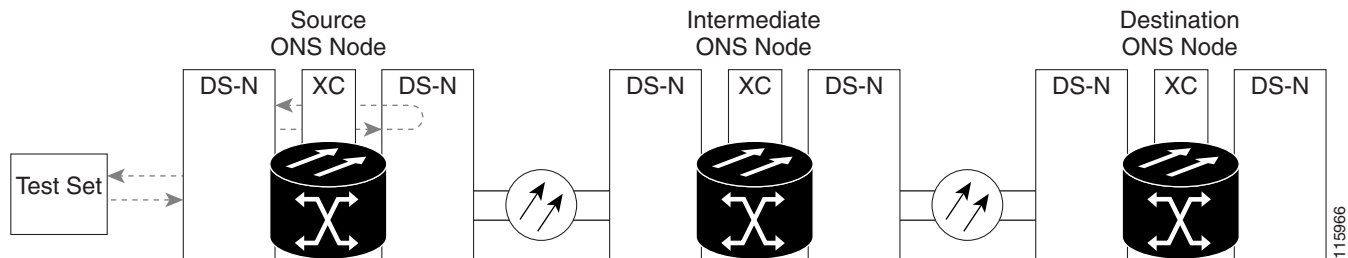

Caution

Performing a loopback on an in-service circuit is service-affecting. To protect traffic, apply a lockout or Force switch to the target loopback port. Refer to the “2.9.2 Protection Switching, Lock Initiation, and Clearing” section on page 2-262 for basic instructions. For more information about these operations, refer to the “Maintain the Node” chapter in the *Cisco ONS 15454 Procedure Guide*.



Caution

In terminal loopback mode, DS3E-12 card does not support sending AIS toward the line side while looping back traffic at the same time, though NE defaults are the same.



Note

Terminal loopbacks require on-site personnel.

**Note**

ONS 15454 DS-3 terminal loopbacks do not transmit an AIS in the direction away from the loopback. Instead of AIS, a continuance of the signal transmitted into the loopback is provided. A DS3/EC1-48 card can be provisioned to transmit AIS for a terminal loopback if desired.

Depending upon your card type, complete the [“Create the Terminal Loopback on a Source DS-1, DS-3, DS3N-12, DS3i-N-12, or EC1 Port”](#) procedure on page 1-41 or the [“Create the Terminal Loopback on a Source DS3E or DS3XM Port”](#) procedure on page 1-43. Then test and clear the loopback as instructed.

Create the Terminal Loopback on a Source DS-1, DS-3, DS3N-12, DS3i-N-12, or EC1 Port

- Step 1** Connect an electrical test set to the port you are testing:
- If you just completed the [“1.2.7 Perform an XC Loopback on a Source-Node OC-N STS \(East to West\) Carrying an Electrical Circuit”](#) procedure on page 1-36, leave the electrical test set hooked up to the DS-N port in the source node.
 - If you are starting the current procedure without the electrical test set hooked up to the DS-N port, use appropriate cabling to attach the Tx and Rx terminals of the electrical test set to the DSx panel or the EIA connectors for the port you are testing. Both Tx and Rx connect to the same port.
- Step 2** Adjust the test set accordingly. (Refer to manufacturer instructions for test-set use.)
- Step 3** In CTC node view, click the **Circuits** tab and click **Create**.
- Step 4** In the Circuit Creation dialog box, choose the type, such as STS, and number, such as 1.
- Step 5** Click **Next**.
- Step 6** In the next Circuit Creation dialog box, give the circuit an easily identifiable name such as DS1toDS4.
- Step 7** Leave the **Bidirectional** check box checked.
- Step 8** Click **Next**.
- Step 9** In the Circuit Creation source dialog box, select the **Node**, card **Slot**, **Port**, and **STS (or VT)** where the test set is connected.
- Step 10** Click **Next**.
- Step 11** In the Circuit Creation destination dialog box, use the same Node, card Slot, Port, and STS (or VT) used for the source dialog box.
- Click **Next**.
 - In the Circuit Creation circuit routing preferences dialog box, leave all defaults. Click **Finish**.
- Step 12** Confirm that the newly created circuit appears in the Dir column as a two-way circuit.

**Note**

It is normal for the [“LPBKTERMINAL \(DS1, DS3\)”](#) condition on page 2-175 to appear during a loopback setup. The condition clears when you remove the loopback.

**Note**



ONS 15454 DS-3 terminal loopbacks do not transmit an AIS in the direction away from the loopback. Instead of AIS, a continuance of the signal transmitted into the loopback is provided. A DS3/EC1-48 card can be provisioned to transmit AIS for a terminal loopback if desired.

- Step 13** Create the terminal loopback on the destination port being tested:
- a. Go to the node view of the destination node:
 - Choose **View > Go To Other Node** from the menu bar.
 - Choose the node from the drop-down list in the Select Node dialog box and click **OK**.
 - b. In node view, double-click the card that requires the loopback, such as the DS-N card in the destination node.
 - c. Click the **Maintenance > Loopback** tabs.
 - d. Select **OOS,MT** from the Admin State column. If this is a multiport card, select the row appropriate for the desired port.
 - e. Select **Terminal** from the Loopback Type column. If this is a multiport card, select the row appropriate for the desired port.
 - f. Click **Apply**.
 - g. Click **Yes** in the confirmation dialog box.
- Step 14** Complete the [“Test and Clear the DS-3, DS3N-12, DS3i-N-12, or EC1 Port Terminal Loopback” procedure on page 1-42](#).
-

Test and Clear the DS-3, DS3N-12, DS3i-N-12, or EC1 Port Terminal Loopback

- Step 1** If the test set is not already sending traffic, send test traffic on the loopback circuit.
- Step 2** Examine the test traffic being received by the test set. Look for errors or any other signal information that the test set is capable of indicating.
- Step 3** If the test set indicates a good circuit, no further testing is necessary on the loopback circuit. Double-click the electrical card in the destination node with the terminal loopback.
- Step 4** Click the **Maintenance > Loopback** tabs.
- Step 5** Select **None** from the Loopback Type column for the port being tested.
- Step 6** Select the appropriate state (**IS; OOS,DSBLD; OOS,MT; IS,AINS**) in the Admin State column for the port being tested.
- Step 7** Click **Apply**.
- Step 8** Click **Yes** in the confirmation dialog box.
- Step 9** Clear the terminal loopback:
- a. Click the **Circuits** tab.
 - b. Choose the loopback circuit being tested.
 - c. Click **Delete**.
 - d. Click **Yes** in the Delete Circuits dialog box. Do not check any check boxes.
- Step 10** Complete the [“Test the Source Electrical Card” procedure on page 1-45](#).
-

Create the Terminal Loopback on a Source DS3E or DS3XM Port

-
- Step 1** Connect an electrical test set to the port you are testing:
- If you just completed the “[1.2.7 Perform an XC Loopback on a Source-Node OC-N STS \(East to West\) Carrying an Electrical Circuit](#)” procedure on page 1-36, leave the electrical test set hooked up to the DS-N port in the source node.
 - If you are starting the current procedure without the electrical test set hooked up to the DS-N port, use appropriate cabling to attach the Tx and Rx terminals of the electrical test set to the DSx panel or the EIA connectors for the port you are testing. Both Tx and Rx connect to the same port.
 - Adjust the test set accordingly. (Refer to manufacturer instructions for test-set use.)
- Step 2** In CTC node view, click the **Circuits** tab and click **Create**.
- Step 3** In the Circuit Creation dialog box, choose the type, such as STS, and number, such as 1.
- Step 4** Click **Next**.
- Step 5** In the next Circuit Creation dialog box, give the circuit an easily identifiable name such as DS1toDS5.
- Step 6** Leave the **Bidirectional** check box checked.
- Step 7** Click **Next**.
- Step 8** In the Circuit Creation source dialog box, select the **Node**, card **Slot**, **Port**, and **STS (or VT)** where the test set is connected.
- Step 9** Click **Next**.
- Step 10** In the Circuit Creation destination dialog box, use the same Node, card Slot, Port, and STS (or VT) used for the source dialog box.
- Click **Next**.
 - In the Circuit Creation circuit routing preferences dialog box, leave all defaults. Click **Finish**.
- Step 11** Confirm that the newly created circuit appears in the Dir column as a two-way circuit.
-
-  **Note** It is normal for the “[LPBKTERMINAL \(DS1, DS3\)](#)” condition on page 2-175 to appear during a loopback setup. The condition clears when you remove the loopback.
-
-  **Note** ONS 15454 DS-3 terminal loopbacks do not transmit an AIS in the direction away from the loopback. Instead of AIS, a continuance of the signal transmitted into the loopback is provided. A DS3/EC1-48 card can be provisioned to transmit AIS for a terminal loopback if desired.
-
- Step 12** Create the terminal loopback on the destination port being tested:
- Go to the node view of the destination node:
 - Choose **View > Go To Other Node** from the menu bar.
 - Choose the node from the drop-down list in the Select Node dialog box and click **OK**.
 - In node view, double-click the card that requires the loopback, such as the DS-N card in the destination node.
 - Click the **Maintenance > DS3** tabs.



Note The DS-3 Admin State is the basis of the DS-1 Derived State.

- Step 13** For the DS3 tab, choose **OOS,MT** from the Admin State column for the port being tested. If this is a multiport card, select the appropriate row for the port being tested. For the DS1 tab, no state selection is necessary unless the DS-1 is in service. The loopback/send code cannot be selected for a DS-1 if the derived state is OOS,DSBLD.
- d. Select **Terminal** from the Loopback Type column. If this is a multiport card, select the row appropriate for the desired port.
 - e. Click **Apply**.
 - f. Click **Yes** in the confirmation dialog box.
- Step 14** Complete the [“Test and Clear the DS3E or DS3XM Port Terminal Loopback Circuit” procedure on page 1-44](#).
-

Test and Clear the DS3E or DS3XM Port Terminal Loopback Circuit

- Step 1** If the test set is not already sending traffic, send test traffic on the loopback circuit.
- Step 2** Examine the test traffic being received by the test set. Look for errors or any other signal information that the test set is capable of indicating.
- Step 3** If the test set indicates a good circuit, no further testing is necessary on the loopback circuit. Double-click the electrical card in the destination node with the terminal loopback.
- Step 4** Depending upon the card type, click the **Maintenance > Loopback** tabs, **Maintenance > DS1** tabs, or **Maintenance > DS3** tabs.



Note The DS-3 Admin State is the basis of the DS-1 Derived State.

- Step 5** Select **None** from the Loopback Type column for the port being tested.
- Step 6** Select the appropriate state (**IS; OOS,DSBLD; OOS,MT; IS,AINS**) in the Admin State column for the port being tested.
- Step 7** Click **Apply**.
- Step 8** Click **Yes** in the confirmation dialog box.
- Step 9** Clear the terminal loopback:
- a. Click the **Circuits** tab.
 - b. Choose the loopback circuit being tested.
 - c. Click **Delete**.
 - d. Click **Yes** in the Delete Circuits dialog box. Do not check any check boxes.
- Step 10** Complete the [“Test the Source Electrical Card” procedure on page 1-45](#).
-

Test the Source Electrical Card

-
- Step 1** Complete the “[Physically Replace a Traffic Card](#)” procedure on page 2-274 for the suspected bad card and replace it with a known-good one.
- Step 2** Resend test traffic on the loopback circuit with a known-good card.
- Step 3** If the test set indicates a good circuit, the problem was probably the defective card. Return the defective card to Cisco through the RMA process. Contact Cisco Technical Support at 1 800 553-2447.
- Step 4** Complete the “[Physically Replace a Traffic Card](#)” procedure on page 2-274 for the defective electrical card.
- Step 5** Clear the terminal loopback state on the port:
- Double-click the electrical card in the destination node with the terminal loopback.
 - Depending upon the card type, click the **Maintenance > Loopback** tabs, **Maintenance > DS1** tabs, or **Maintenance > DS3** tabs.
-  **Note** The DS-3 Admin State is the basis of the DS-1 Derived State.
-
- Select **None** from the Loopback Type column for the port being tested.
 - Select the appropriate state (**IS; OOS,DSBLD; OOS,MT; IS,AINS**) in the Admin State column for the port being tested.
 - Click **Apply**.
 - Click **Yes** in the confirmation dialog box.
- Step 6** Delete the terminal loopback circuit:
- Click the **Circuits** tab.
 - Choose the loopback circuit being tested.
 - Click **Delete**.
- All tests for this circuit are completed.
-

1.3 Troubleshooting DS3XM-6 or DS3XM-12 Card Electrical Paths With FEAC Loopbacks

The DS3XM-6 card and DS3XM-12 cards support FEAC functions that are not available on basic DS-3 cards. Click the DS3XM-6 or DS3XM-12 **Maintenance > DS1** tabs at the card view to reveal the two additional function columns. [Figure 1-19](#) shows the DS3 subtab and the additional Send Code and Inhibit FE Lbk function columns.

Figure 1-19 Accessing FEAC Functions on the DS3XM-6 Card

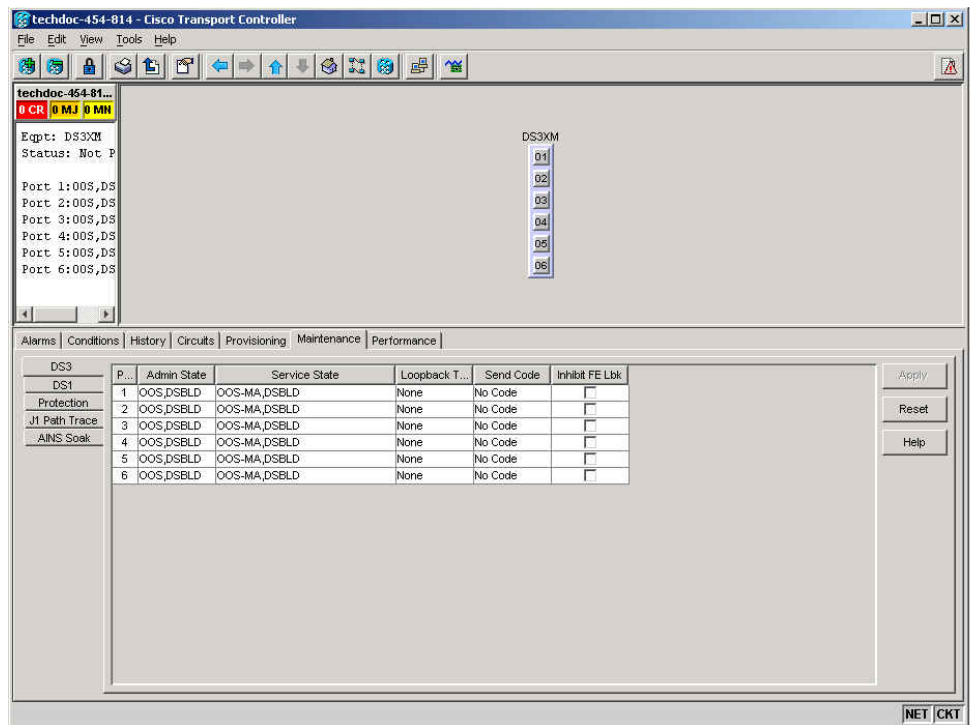

The “far end” in FEAC refers to the equipment connected to the DS3XM card and not to the far end of a circuit. In Figure 1-20, if a DS3XM-6 (near-end) port is configured to send a line loop code, the code will be sent to the connected test set, not the DS3XM-6 (far-end) port.

Figure 1-20 Diagram of FEAC Circuit

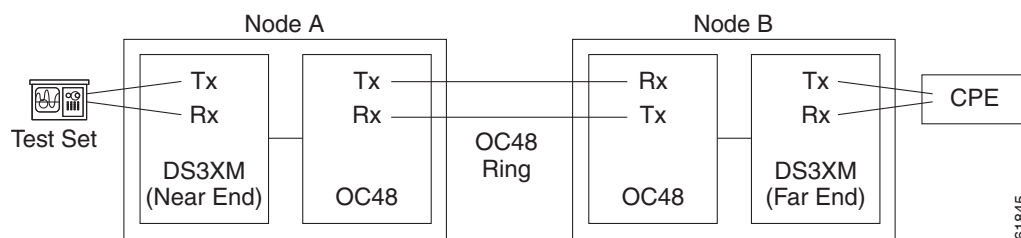

1.3.1 FEAC Send Code

The Send Code column on the DS3XM-6 or DS3XM-12 card Maintenance tab only applies to OOS-MA,MT ports configured for CBIT framing. The column lets a user select No Code (the default) or line loop code. Selecting line loop code inserts a line loop activate FEAC in the CBIT overhead transmitting to the connected facility. This code initiates a loopback from the facility to the ONS 15454. Selecting No Code sends a line-loop-deactivate FEAC code to the connected equipment, which will remove the loopback. You can also insert a FEAC for the 28 individual DS-1 circuits transmuted into a DS-3 circuit.

1.3.2 DS-3E and DS3i-N-12 Inhibit Loopback

DS-3E and DS-3i-N-12 cards respond to (but do not send) DS-3-level FEAC codes. You can inhibit FEAC response on ports for these cards using the Inhibit Lbk check box on their Maintenance windows.

1.3.3 DS3XM-6 and DS3XM-12 Inhibit FEAC Loopback

DS3XM-6 and DS3XM-12 ports and transmuted DS-1 circuits initiate loopbacks when they receive FEAC line loop codes. If the Inhibit FE Lbk check box is checked for a DS-3 port, that port ignores any FEAC line loop codes it receives and will not loop back (return them). Only DS-3 ports can be configured to inhibit FEAC loopback responses; individual DS-1 ports (accessed on the DS3XM DS1 tab) cannot inhibit their responses. If you inhibit a DS-3 port's far end loopback response, this DS-3 port and the DS-1 lines it contains are not restricted from terminal or facility loopbacks.

1.3.4 FEAC Alarms

When an ONS 15454 port receives an activation code for a FEAC loopback, it raises the [“LPBKDS3FEAC” condition on page 2-169](#). The condition clears when the port receives the command to deactivate the FEAC loopback. If a node sends a FEAC loopback command to the far end, the sending node raises a [“LPBKDS3FEAC-CMD” condition on page 2-169](#) for the near-end port.

1.4 Troubleshooting Optical Circuit Paths With Loopbacks

Facility loopbacks, terminal loopbacks, and cross-connect loopback circuits are often used together to test the circuit path through the network or to logically isolate a fault. Performing a loopback test at each point along the circuit path systematically isolates possible points of failure.

The procedures in this section apply to OC-N cards. For instructions on G-Series Ethernet cards, see the [“1.5 Troubleshooting Ethernet Circuit Paths With Loopbacks” section on page 1-68](#). The example in this section tests an OC-N circuit on a three-node BLSR. Using a series of facility, cross-connect, and terminal loopbacks, the example scenario traces the circuit path, tests the possible failure points, and eliminates them. The logical progression contains seven network test procedures:

**Note**

The test sequence for your circuits will differ according to the type of circuit and network topology.

1. A facility loopback on the source-node OC-N port
2. A terminal loopback on the source-node OC-N port
3. A cross-connect loopback on the source OC-N port
4. A facility loopback on the intermediate-node OC-N port
5. A terminal loopback on the intermediate-node OC-N port
6. A facility loopback on the destination-node OC-N port
7. A terminal loopback on the destination-node OC-N port

**Note**

Facility and terminal loopback tests require on-site personnel.

1.4.1 Perform a Facility Loopback on a Source-Node Optical Port

The facility loopback test is performed on the node source port in the network circuit. In the testing situation used in this example, the source OC-N port in the source node. Completing a successful facility loopback on this port isolates the OC-N port as a possible failure point. [Figure 1-21](#) shows an example of a facility loopback on a circuit source OC-N port.

Figure 1-21 Facility Loopback on a Circuit Source OC-N Port

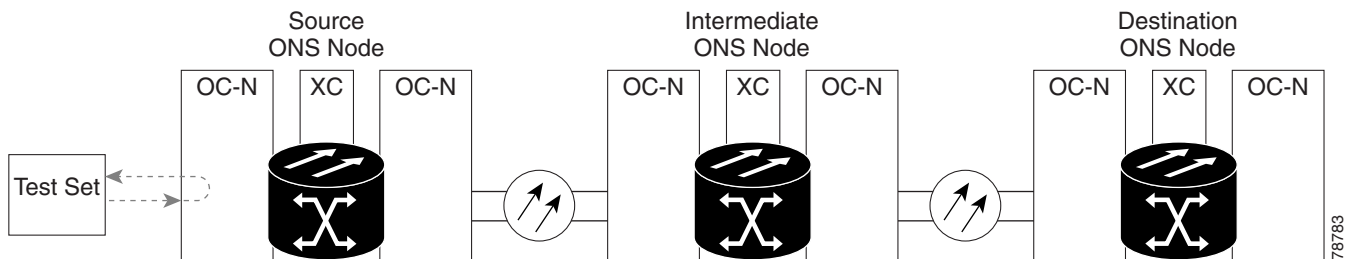

Caution

Performing a loopback on an in-service circuit is service-affecting.



Note

Facility loopbacks require on-site personnel.

Complete the [“Create the Facility Loopback on the Source Optical Port”](#) procedure on page 1-48.

Create the Facility Loopback on the Source Optical Port

Step 1 Connect an optical test set to the port you are testing.



Note For specific procedures to connect, set up, and use the test set equipment, consult the manufacturer.

Use appropriate cabling to attach the Tx and Rx terminals of the optical test set to the port you are testing. The Tx and Rx terminals connect to the same port. Adjust the test set accordingly. (Refer to manufacturer instructions for test-set use.)

Step 2 In CTC node view, double-click the card to open the card view.

Step 3 Click the **Maintenance > Loopback > Port** tabs.

Step 4 Choose **OOS,MT** from the Admin State column for the port being tested. If this is a multiport card, select the appropriate row for the desired port.

Step 5 Choose **Facility** from the Loopback Type column for the port being tested. If this is a multiport card, select the appropriate row for the desired port.

Step 6 Click **Apply**.

Step 7 Click **Yes** in the confirmation dialog box.

**Note**

It is normal for the “CLPBKFACILITY (OCN)” condition on page 2-173 or the “LPBKFACILITY (G1000)” condition on page 2-172 to appear during loopback setup. The condition clears when you remove the loopback.

- Step 8** Complete the “[Test and Clear the Facility Loopback Circuit](#)” procedure on page 1-49.

Test and Clear the Facility Loopback Circuit

- Step 1** If the test set is not already sending traffic, send test traffic on the loopback circuit.
- Step 2** Examine the traffic received by the test set. Look for errors or any other signal information that the test set is capable of indicating.
- Step 3** If the test set indicates a good circuit, no further testing is necessary with the facility loopback. Clear the facility loopback:
- Click the **Maintenance > Loopback > Port** tabs.
 - Choose **None** from the Loopback Type column for the port being tested.
 - Choose the appropriate state (**IS; OOS,DSBLD; OOS,MT; IS,AINS**) from the Admin State column for the port being tested.
 - Click **Apply**.
 - Click **Yes** in the confirmation dialog box.
- Step 4** Complete the “[Test the OC-N Card](#)” procedure on page 1-49.

Test the OC-N Card

- Step 1** Complete the “[Physically Replace a Traffic Card](#)” procedure on page 2-274 for the suspected bad card and replace it with a known-good one.
- Step 2** Resend test traffic on the loopback circuit with a known-good card installed.
- Step 3** If the test set indicates a good circuit, the problem was probably the defective card. Return the defective card to Cisco through the RMA process. Contact Cisco Technical Support at 1 800 553-2447.
- Step 4** Complete the “[Physically Replace a Traffic Card](#)” procedure on page 2-274 for the faulty card.
- Step 5** Clear the facility loopback:
- Click the **Maintenance > Loopback > Port** tabs.
 - Choose **None** from the Loopback Type column for the port being tested.
 - Choose the appropriate state (**IS; OOS,DSBLD; OOS,MT; IS,AINS**) from the Admin State column for the port being tested.
 - Click **Apply**.
 - Click **Yes** in the confirmation dialog box.

- Step 6** Complete the “1.4.2 Perform a Terminal Loopback on a Source-Node Optical Port” procedure on page 1-50.

1.4.2 Perform a Terminal Loopback on a Source-Node Optical Port

The terminal loopback test is performed on the source-node optical port. For the circuit in this example, it is the source OC-N port in the source node. You first create a bidirectional circuit that starts on the node destination optical port and loops back on the node source optical port. You then proceed with the terminal loopback test. Completing a successful terminal loopback to a node source port verifies that the circuit is good to the source port. Figure 1-22 shows an example of a terminal loopback on a source OC-N port.

Figure 1-22 Terminal Loopback on a Source-Node OC-N Port

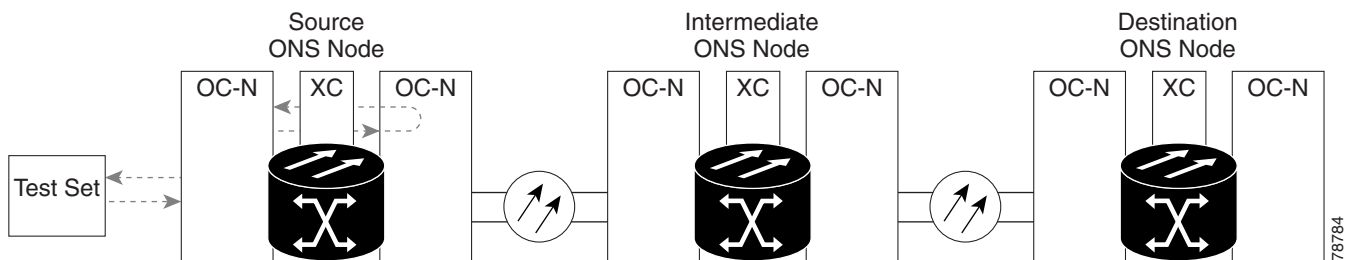

OC-N cards in terminal loopback state display an icon in CTC, shown in Figure 1-23.

Figure 1-23 Terminal Loopback Indicator



Caution Performing a loopback on an in-service circuit is service-affecting.



Note Terminal loopbacks require on-site personnel.

Complete the “Create the Terminal Loopback on a Source-Node Optical Port” procedure on page 1-50.

Create the Terminal Loopback on a Source-Node Optical Port

- Step 1** Connect an optical test set to the port you are testing:



Note For specific procedures to connect, set up, and use the test set equipment, consult the manufacturer.

- a. If you just completed the [“1.4.1 Perform a Facility Loopback on a Source-Node Optical Port” procedure on page 1-48](#), leave the optical test set hooked up to the OC-N port in the source node.
- b. If you are starting the current procedure without the optical test set hooked up to the source port, use appropriate cabling to attach the Tx and Rx terminals of the optical test set to the port you are testing. Both Tx and Rx connect to the same port.
- c. Adjust the test set accordingly. (Refer to manufacturer instructions for test-set use.)

Step 2 Use CTC to set up the terminal loopback on the test port:

- a. In node view, click the **Circuits** tab and click **Create**.
- b. In the Circuit Creation dialog box, choose the type, such as STS, and number, such as 1.
- c. Click **Next**.
- d. In the next Circuit Creation dialog box, give the circuit an easily identifiable name such as OCN1toOCN2.
- e. Leave the **Bidirectional** check box checked.
- f. Click **Next**.
- g. In the Circuit Creation source dialog box, select the same Node, card Slot, Port, and STS (or VT) where the test set is connected.
- h. Click **Next**.
- i. In the Circuit Creation destination dialog box, use the same Node, card Slot, Port, and STS (or VT) used for the source dialog box.
- j. Click **Next**.
- k. In the Circuit Creation circuit routing preferences dialog box, leave all defaults. Click **Finish**.

Step 3 Confirm that the newly created circuit appears on the Circuits tab list as a two-way circuit.



Note It is normal for the [“LPBKTERMINAL \(OCN\)” condition on page 2-177](#) to appear during a loopback setup. The condition clears when you remove the loopback.

Step 4 Create the terminal loopback on the destination port being tested:

- a. In node view, double-click the card that requires the loopback, such as the destination OC-N card in the source node.
- b. Click the **Maintenance > Loopback > Port** tabs.
- c. Select **OOS,MT** from the Admin State column. If this is a multiport card, select the row appropriate for the desired port.
- d. Select **Terminal** from the Loopback Type column. If this is a multiport card, select the row appropriate for the desired port.
- e. Click **Apply**.
- f. Click **Yes** in the confirmation dialog box.

- Step 5** Complete the [“Test and Clear the Terminal Loopback Circuit” procedure on page 1-52](#).
-

Test and Clear the Terminal Loopback Circuit

- Step 1** If the test set is not already sending traffic, send test traffic on the loopback circuit.
- Step 2** Examine the test traffic being received by the test set. Look for errors or any other signal information that the test set is capable of indicating.
- Step 3** If the test set indicates a good circuit, no further testing is necessary on the loopback circuit. Clear the terminal loopback state on the port:
- Double-click the card in the source node with the terminal loopback.
 - Click the **Maintenance > Loopback > Port** tabs.
 - Select **None** from the Loopback Type column for the port being tested.
 - Select the appropriate state (**IS; OOS,DSBLD; OOS,MT; IS,AINS**) in the Admin State column for the port being tested.
 - Click **Apply**.
 - Click **Yes** in the confirmation dialog box.
- Step 4** Clear the terminal loopback circuit:
- Click the **Circuits** tab.
 - Choose the loopback circuit being tested.
 - Click **Delete**.
 - Click **Yes** in the Delete Circuits dialog box. Do not check any check boxes.
- Step 5** Complete the [“Test the Optical Card” procedure on page 1-52](#).
-

Test the Optical Card

- Step 1** Complete the [“Physically Replace a Traffic Card” procedure on page 2-274](#) for the suspected bad card and replace it with a known-good one.
- Step 2** Resend test traffic on the loopback circuit with a known-good card.
- Step 3** If the test set indicates a good circuit, the problem was probably the defective card. Return the defective card to Cisco through the RMA process. Contact Cisco Technical Support at 1 800 553-2447.
- Step 4** Complete the [“Physically Replace a Traffic Card” procedure on page 2-274](#) for the defective card.
- Step 5** Clear the terminal loopback on the port before testing the next segment of the network circuit path:
- Double-click the card in the source node with the terminal loopback.
 - Click the **Maintenance > Loopback > Port** tabs.
 - Select **None** from the Loopback Type column for the port being tested.
 - Select the appropriate state (**IS; OOS,DSBLD; OOS,MT; IS,AINS**) in the Admin State column for the port being tested.

- e. Click **Apply**.
 - f. Click **Yes** in the confirmation dialog box.
- Step 6** Clear the terminal loopback circuit before testing the next segment of the network circuit path:
- a. Click the **Circuits** tab.
 - b. Choose the loopback circuit being tested.
 - c. Click **Delete**.
 - d. Click **Yes** in the Delete Circuits dialog box. Do not check any check boxes.
- Step 7** Complete the “[1.4.3 Perform an XC Loopback on the Source Optical Port](#)” procedure on page 1-53.

1.4.3 Perform an XC Loopback on the Source Optical Port



Note This procedure is only performed on OC-N cards and tests the cross-connect circuit connection.



Note You can perform an XC loopback on either the circuit source working or the protect port of a 1+1 protection group.



Note XC loopbacks do not require on-site personnel.

The XC loopback test occurs on the cross-connect card in a network circuit. Completing a successful XC loopback from an OC-N card through the cross-connect card eliminates the cross-connect card as the source of trouble for a faulty circuit. [Figure 1-24](#) shows an example of an XC loopback path on a source OC-N port.

Figure 1-24 XC Loopback on a Source OC-N Port

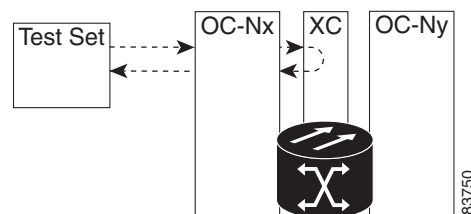

Complete the “[Create the XC Loopback on the Source-Node Optical Port](#)” procedure on page 1-53.

Create the XC Loopback on the Source-Node Optical Port

- Step 1** Connect an optical test set to the port you are testing:



Note For specific procedures to connect, set up, and use the test set equipment, consult the manufacturer.

- a. If you just completed the [“1.4.2 Perform a Terminal Loopback on a Source-Node Optical Port” procedure on page 1-50](#), leave the optical test set hooked up to the source-node port.
- b. If you are starting the current procedure without the optical test set hooked up to the source port, use appropriate cabling to attach the Tx and Rx terminals of the optical test set to the port you are testing. The Tx and Rx terminals connect to the same port.

Step 2 Adjust the test set accordingly. (Refer to manufacturer instructions for test-set use.)

Step 3 Use CTC to put the circuit being tested out of service:

- a. In node view, click the **Circuits** tab.
- b. Click the circuit and then click **Edit**.
- c. In the Edit Circuit dialog box, click the State tab.
- d. Choose **OOS,MT** from the Target Circuit Admin State drop-down list.
- e. Click **Apply**.
- f. Click **Yes** in the confirmation dialog box.

Step 4 Use CTC to set up the XC loopback on the circuit being tested:

- a. In node view, double-click the OC-N card to open the card view.
- b. Click the **Maintenance > Loopback > SONET STS** tabs.
- c. Click the check box in the **XC Loopback** column for the port being tested.
- d. Click **Apply**.
- e. Click **Yes** in the confirmation dialog box.

Step 5 Complete the [“Test and Clear the XC Loopback Circuit” procedure on page 1-54](#).

Test and Clear the XC Loopback Circuit



Note This procedure is performed only on OC-N cards.

Step 1 If the test set is not already sending traffic, send test traffic on the loopback circuit.

Step 2 Examine the test traffic received by the test set. Look for errors or any other signal information that the test set is capable of indicating.

Step 3 If the test set indicates a good circuit, no further testing is necessary with the cross-connect. Clear the XC loopback:

- a. In card view, click the **Maintenance > Loopback > SONET STS** tabs.
- b. Uncheck the check box in the **XC Loopback** column for the circuit being tested.
- c. Click **Apply**.
- d. Click **Yes** in the confirmation dialog box.

- Step 4** Complete the “[Test the Standby Cross-Connect Card](#)” procedure on page 1-55.
-

Test the Standby Cross-Connect Card



Note This procedure is performed only on cross-connect cards.

- Step 1** Perform a reset on the standby cross-connect card:
- Determine the standby cross-connect card. On both the physical node and the CTC node view window, the standby cross-connect ACT/SBY LED is amber and the active card ACT/SBY LED is green.
 - Position the cursor over the standby cross-connect card.
 - Right-click and choose **RESET CARD**.
 - Click **Yes** in the confirmation dialog box.

- Step 2** Initiate an external switching command (side switch) on the cross-connect cards before you retest the loopback circuit:



Caution Cross-connect side switches, with the exception of side switches using XC-VXC-10G cards, are service-affecting. Any live traffic on any card in the node endures a hit of up to 50 ms. XC-VXC-10G side switches are errorless.

- Determine the standby cross-connect card. On both the physical node and the CTC node view window, the standby cross-connect ACT/SBY LED is amber and the active card ACT/SBY LED is green.
- In the node view, select the **Maintenance > Cross-Connect > Cards** tabs.
- In the Cross-Connect Cards area, click **Switch**.
- Click **Yes** in the Confirm Switch dialog box.



Note After the active cross-connect goes into standby mode, the original standby card becomes active and its ACT/SBY LED turns green. The former active card becomes standby and its ACT/SBY LED turns amber.

- Step 3** Resend test traffic on the loopback circuit.

The test traffic now travels through the alternate cross-connect card.

- Step 4** If the test set indicates a faulty circuit, assume the cross-connect card is not causing the problem. Clear the XC loopback circuit:
- Click the **Circuits** tab.
 - Choose the XC loopback circuit being tested.
 - Click **Delete**.
 - Click **Yes** in the Delete Circuits dialog box. Do not check any check boxes.

- e. Confirm that the XC loopback circuit is deleted from the Circuits tab list. If the test set indicates a good circuit, the problem might be a defective cross-connect card.

Step 5 To confirm a defective original cross-connect card, complete the [“Retest the Original Cross-Connect Card” procedure on page 1-56](#).

Retest the Original Cross-Connect Card



Note

This procedure is performed only on OC-N and cross-connect cards.

- Step 1** Initiate an external switching command (side switch) on the cross-connect cards.
- a. Determine the standby cross-connect card. On both the physical node and the CTC node view window, the standby cross-connect ACT/SBY LED is amber and the active card ACT/SBY LED is green.
 - b. In node view, select the **Maintenance > Cross-Connect > Cards** tabs.
 - c. In the Cross-Connect Cards area, click **Switch**.
 - d. Click **Yes** in the Confirm Switch dialog box.



Note

After the active cross-connect goes into standby mode, the original standby card becomes active and its ACT/SBY LED turns green. The former active card becomes standby and its ACT/SBY LED turns amber.

- Step 2** Resend test traffic on the loopback circuit.
- Step 3** If the test set indicates a faulty circuit, the problem is probably the defective card. Return the defective card to Cisco through the RMA process. Contact Cisco Technical Support at 1 800 553-2447 and proceed to [Step 4](#). If the circuit is not shown to be faulty and the card is not shown to be defective, you are finished with testing.
- Step 4** Complete the [“Physically Replace an In-Service Cross-Connect Card” procedure on page 2-274](#) for the defective card.
- Step 5** If the test set indicates a good circuit, the cross-connect card might have had a temporary problem that was cleared by the side switch. Clear the XC loopback circuit:
- a. Click the **Circuits** tab.
 - b. Choose the XC loopback circuit being tested.
 - c. Click **Delete**.
 - d. Click **Yes** in the Delete Circuits dialog box. Do not check any check boxes.
- Step 6** Complete the [“1.4.4 Perform a Facility Loopback on an Intermediate-Node Optical Port” procedure on page 1-57](#).
-

1.4.4 Perform a Facility Loopback on an Intermediate-Node Optical Port

Performing the facility loopback test on an intermediate port isolates whether this node is causing circuit failure. In the situation shown in [Figure 1-25](#), the test is being performed on an intermediate OC-N port.

Figure 1-25 Facility Loopback Path to an Intermediate-Node OC-N Port

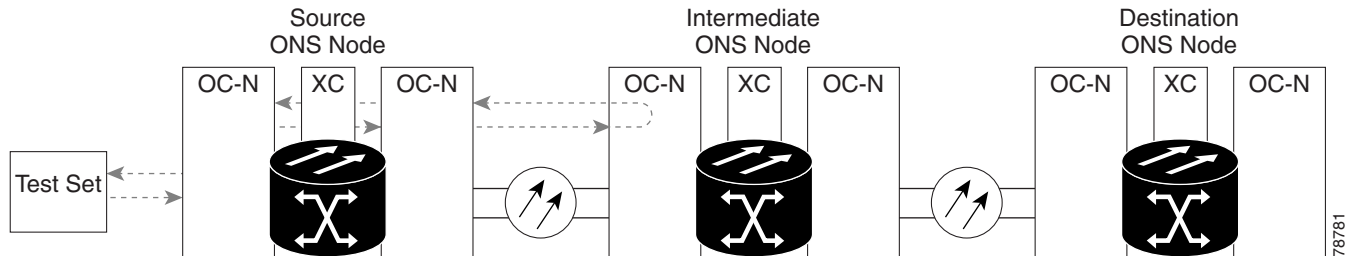

Caution

Performing a loopback on an in-service circuit is service-affecting.



Note

Facility loopbacks require on-site personnel.

Complete the [“Create a Facility Loopback on an Intermediate-Node Optical Port” procedure on page 1-57](#).

Create a Facility Loopback on an Intermediate-Node Optical Port

Step 1 Connect an optical test set to the port you are testing:



Note

For specific procedures to connect, set up, and use the test set equipment, consult the manufacturer.

- a. If you just completed the [“1.4.3 Perform an XC Loopback on the Source Optical Port” procedure on page 1-53](#), leave the optical test set hooked up to the source-node port.
- b. If you are starting the current procedure without the optical test set hooked up to the source port, use appropriate cabling to attach the Tx and Rx terminals of the optical test set to the port you are testing. Both Tx and Rx connect to the same port.

Step 2 Adjust the test set accordingly. (Refer to manufacturer instructions for test-set use.)

Step 3 Use CTC to set up the facility loopback on the test port:

- a. In node view, click the **Circuits** tab and click **Create**.
- b. In the Circuit Creation dialog box, choose the type, such as STS, and number, such as 1.
- c. Click **Next**.
- d. In the next Circuit Creation dialog box, give the circuit an easily identifiable name such as OCN1toOCN3.
- e. Leave the **Bidirectional** check box checked.

- f. Click **Next**.
- g. In the Circuit Creation source dialog box, select the same Node, card Slot, Port, and STS (or VT) where the test set is connected.
- h. Click **Next**.
- i. In the Circuit Creation destination dialog box, use the same Node, card Slot, Port, and STS (or VT) used for the source dialog box.
- j. Click **Next**.
- k. In the Circuit Creation circuit routing preferences dialog box, leave all defaults. Click **Finish**.

Step 4 Confirm that the newly created circuit appears on the Circuits tab list as a two-way circuit.



Note It is normal for the “[CLPBK FACILITY \(OCN\)](#)” condition on page 2-173 to appear during a loopback setup. The condition clears when you remove the loopback.

Step 5 Create the facility loopback on the destination port being tested:

- a. Go to the node view of the intermediate node:
 - Choose **View > Go To Other Node** from the menu bar.
 - Choose the node from the drop-down list in the Select Node dialog box and click **OK**.
- b. In node view, double-click the intermediate-node card that requires the loopback.
- c. Click the **Maintenance > Loopback > Port** tabs.
- d. Select **OOS,MT** from the Admin State column. If this is a multiport card, select the row appropriate for the desired port.
- e. Select **Facility** from the Loopback Type column. If this is a multiport card, select the row appropriate for the desired port.
- f. Click **Apply**.
- g. Click **Yes** in the confirmation dialog box.

Step 6 Complete the “[Test and Clear the Facility Loopback Circuit](#)” procedure on page 1-58.

Test and Clear the Facility Loopback Circuit

- Step 1** If the test set is not already sending traffic, send test traffic on the loopback circuit.
- Step 2** Examine the traffic received by the test set. Look for errors or any other signal information that the test set is capable of indicating.
- Step 3** If the test set indicates a good circuit, no further testing is necessary with the facility loopback. Clear the facility loopback from the port:
 - a. Click the **Maintenance > Loopback > Port** tabs.
 - b. Choose **None** from the Loopback Type column for the port being tested.
 - c. Choose the appropriate state (**IS; OOS,DSBLD; OOS,MT; IS,AINS**) from the Admin State column for the port being tested.
 - d. Click **Apply**.

- e. Click **Yes** in the confirmation dialog box.
- Step 4** Clear the facility loopback circuit:
- a. Click the **Circuits** tab.
 - b. Choose the loopback circuit being tested.
 - c. Click **Delete**.
 - d. Click **Yes** in the Delete Circuits dialog box. Do not check any check boxes.
- Step 5** Complete the [“Test the Optical Card” procedure on page 1-59](#).
-

Test the Optical Card

- Step 1** Complete the [“Physically Replace a Traffic Card” procedure on page 2-274](#) for the suspected bad card and replace it with a known-good one.
- Step 2** Resend test traffic on the loopback circuit with a known-good card installed.
- Step 3** If the test set indicates a good circuit, the problem was probably the defective card. Return the defective card to Cisco through the RMA process. Contact Cisco Technical Support at 1 800 553-2447.
- Step 4** Complete the [“Physically Replace a Traffic Card” procedure on page 2-274](#) for the faulty card.
- Step 5** Clear the facility loopback from the port:
- a. Click the **Maintenance > Loopback > Port** tabs.
 - b. Choose **None** from the Loopback Type column for the port being tested.
 - c. Choose the appropriate state (**IS; OOS,DSBLD; OOS,MT; IS,AINS**) from the Admin State column for the port being tested.
 - d. Click **Apply**.
 - e. Click **Yes** in the confirmation dialog box.
- Step 6** Clear the facility loopback circuit:
- a. Click the **Circuits** tab.
 - b. Choose the loopback circuit being tested.
 - c. Click **Delete**.
 - d. Click **Yes** in the Delete Circuits dialog box. Do not check any check boxes.
- Step 7** Complete the [“1.4.5 Perform a Terminal Loopback on Intermediate-Node Optical Ports” procedure on page 1-59](#).
-

1.4.5 Perform a Terminal Loopback on Intermediate-Node Optical Ports

In the next troubleshooting test, you perform a terminal loopback on the intermediate-node port to isolate whether the destination port is causing circuit trouble. In the example situation in [Figure 1-26](#), the terminal loopback is performed on an intermediate optical port in the circuit. You first create a

1.4.5 Perform a Terminal Loopback on Intermediate-Node Optical Ports

bidirectional circuit that originates on the source-node optical port and loops back on the intermediate-node port. You then proceed with the terminal loopback test. If you successfully complete a terminal loopback on the node, this node is excluded from possible sources of circuit trouble.

Figure 1-26 Terminal Loopback Path to an Intermediate-Node OC-N Port

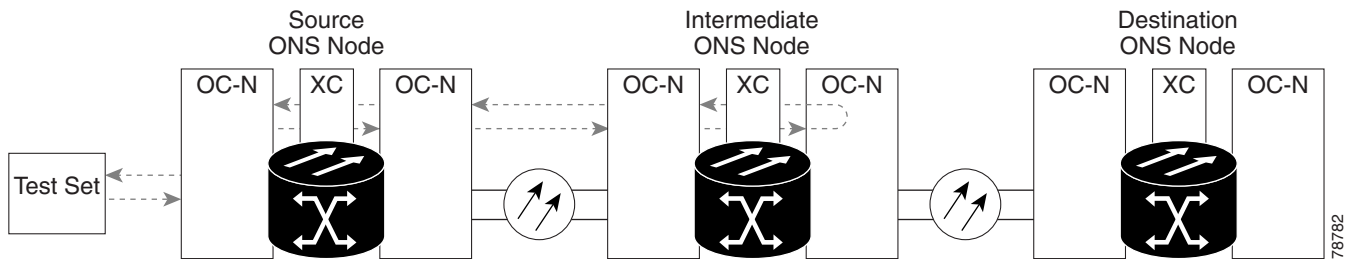

OC-N cards placed in facility loopback state display an icon, shown in [Figure 1-27](#).

Figure 1-27 Facility Loopback Indicator

**Caution**

Performing a loopback on an in-service circuit is service-affecting.

**Note**

Terminal loopbacks require on-site personnel.

Complete the [“Create a Terminal Loopback on Intermediate-Node Optical Ports”](#) procedure on [page 1-60](#).

Create a Terminal Loopback on Intermediate-Node Optical Ports

Step 1 Connect an optical test set to the port you are testing:

**Note**

For specific procedures to connect, set up, and use the test set equipment, consult the manufacturer.

- a. If you just completed the [“1.4.4 Perform a Facility Loopback on an Intermediate-Node Optical Port”](#) section on [page 1-57](#), leave the optical test set hooked up to the source-node port.
- b. If you are starting the current procedure without the optical test set hooked up to the source port, use appropriate cabling to attach the Tx and Rx terminals of the optical test set to the port you are testing. Both Tx and Rx connect to the same port.

Step 2 Adjust the test set accordingly. (Refer to manufacturer instructions for test-set use.)

Step 3 Use CTC to set up the terminal loopback on the test port:

- a. In node view, click the **Circuits** tab and click **Create**.
- b. In the Circuit Creation dialog box, choose the type, such as STS, and number, such as 1.

- c. Click **Next**.
 - d. In the next Circuit Creation dialog box, give the circuit an easily identifiable name such as OCN1toOCN4.
 - e. Leave the **Bidirectional** check box checked.
 - f. Click **Next**.
 - g. In the Circuit Creation source dialog box, select the same Node, card Slot, Port, and STS (or VT) where the test set is connected.
 - h. Click **Next**.
 - i. In the Circuit Creation destination dialog box, use the same Node, card Slot, Port, and STS (or VT) used for the source dialog box.
 - j. Click **Next**.
 - k. In the Circuit Creation circuit routing preferences dialog box, leave all defaults. Click **Finish**.
- Step 4** Confirm that the newly created circuit appears on the Circuits tab list and that it is described in the Dir column as a two-way circuit.



Note It is normal for the “[LPBKTERMINAL \(OCN\)](#)” condition on page 2-177 to appear during a loopback setup. The condition clears when you remove the loopback.

- Step 5** Create the terminal loopback on the destination port being tested:
- a. Go to the node view of the intermediate node:
 - Choose **View > Go To Other Node** from the menu bar.
 - Choose the node from the drop-down list in the Select Node dialog box and click **OK**.
 - b. In node view, double-click the card that requires the loopback.
 - c. Click the **Maintenance > Loopback > Port** tabs.
 - d. Select **OOS,MT** from the Admin State column. If this is a multiport card, select the row appropriate for the desired port.
 - e. Select **Terminal** from the Loopback Type column. If this is a multiport card, select the row appropriate for the desired port.
 - f. Click **Apply**.
 - g. Click **Yes** in the confirmation dialog box.
- Step 6** Complete the “[Test and Clear the Optical Terminal Loopback Circuit](#)” procedure on page 1-61.

Test and Clear the Optical Terminal Loopback Circuit

- Step 1** If the test set is not already sending traffic, send test traffic on the loopback circuit.
- Step 2** Examine the test traffic being received by the test set. Look for errors or any other signal information that the test set is capable of indicating.
- Step 3** If the test set indicates a good circuit, no further testing is necessary on the loopback circuit. Clear the terminal loopback from the port:
- a. Double-click the intermediate-node card with the terminal loopback to open the card view.

- b. Click the **Maintenance > Loopback > Port** tabs.
 - c. Select **None** from the Loopback Type column for the port being tested.
 - d. Select the appropriate state (**IS; OOS,DSBLD; OOS,MT; IS,AINS**) in the Admin State column for the port being tested.
 - e. Click **Apply**.
 - f. Click **Yes** in the confirmation dialog box.
- Step 4** Clear the terminal loopback circuit:
- a. Click the **Circuits** tab.
 - b. Choose the loopback circuit being tested.
 - c. Click **Delete**.
 - d. Click **Yes** in the Delete Circuits dialog box. Do not check any check boxes.
- Step 5** Complete the [“Test the Optical Card” procedure on page 1-62.](#)
-

Test the Optical Card

- Step 1** Complete the [“Physically Replace a Traffic Card” procedure on page 2-274](#) for the suspected bad card and replace it with a known-good one.
- Step 2** Resend test traffic on the loopback circuit with a known-good card.
- Step 3** If the test set indicates a good circuit, the problem was probably the defective card. Return the defective card to Cisco through the RMA process. Contact Cisco Technical Support at 1 800 553-2447.
- Step 4** Complete the [“Physically Replace a Traffic Card” procedure on page 2-274](#) for the defective card.
- Step 5** Clear the terminal loopback on the port:
- a. Double-click the source-node card with the terminal loopback.
 - b. Click the **Maintenance > Loopback > Port** tabs.
 - c. Select **None** from the Loopback Type column for the port being tested.
 - d. Select the appropriate state (**IS; OOS,DSBLD; OOS,MT; IS,AINS**) in the Admin State column for the port being tested.
 - e. Click **Apply**.
 - f. Click **Yes** in the confirmation dialog box.
- Step 6** Clear the terminal loopback circuit:
- a. Click the **Circuits** tab.
 - b. Choose the loopback circuit being tested.
 - c. Click **Delete**.
 - d. Click **Yes** in the Delete Circuits dialog box. Do not check any check boxes.
- Step 7** Complete the [“1.4.6 Perform a Facility Loopback on a Destination-Node Optical Port” procedure on page 1-63.](#)
-

1.4.6 Perform a Facility Loopback on a Destination-Node Optical Port

You perform a facility loopback test at the destination port to determine whether this local port is the source of circuit trouble. The example in [Figure 1-28](#) shows a facility loopback being performed on a destination-node OC-N port.

Figure 1-28 Facility Loopback Path to a Destination-Node OC-N Port

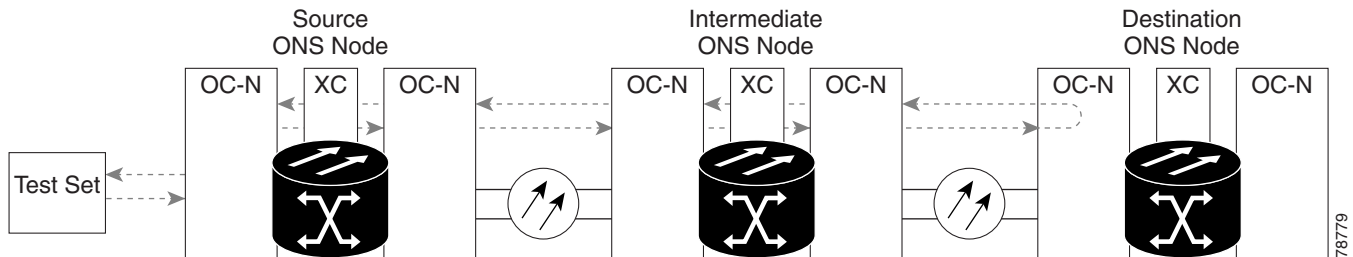

Caution

Performing a loopback on an in-service circuit is service-affecting.



Note

Facility loopbacks require on-site personnel.

Complete the [“Create the Facility Loopback on a Destination-Node Optical Port” procedure on page 1-63](#).

Create the Facility Loopback on a Destination-Node Optical Port

Step 1 Connect an optical test set to the port you are testing:



Note

For specific procedures to connect, set up, and use the test set equipment, consult the manufacturer.

- a. If you just completed the [“1.4.5 Perform a Terminal Loopback on Intermediate-Node Optical Ports” procedure on page 1-59](#), leave the optical test set hooked up to the source-node port.
- b. If you are starting the current procedure without the optical test set hooked up to the source port, use appropriate cabling to attach the Tx and Rx terminals of the optical test set to the port you are testing. Both Tx and Rx connect to the same port.

Step 2 Adjust the test set accordingly. (Refer to manufacturer instructions for test-set use.)

Step 3 Use CTC to set up the hairpin circuit on the test port:

- a. In node view, click the **Circuits** tab and click **Create**.
- b. In the Circuit Creation dialog box, choose the type, such as STS, and number, such as 1.
- c. Click **Next**.
- d. In the next Circuit Creation dialog box, give the circuit an easily identifiable name such as OCN1toOCN5.

1.4.6 Perform a Facility Loopback on a Destination-Node Optical Port

- e. Leave the **Bidirectional** check box checked.
- f. Click **Next**.
- g. In the Circuit Creation source dialog box, select the same Node, card Slot, Port, and STS (or VT) where the test set is connected.
- h. Click **Next**.
- i. In the Circuit Creation destination dialog box, use the same Node, card Slot, Port, and STS (or VT) used for the source dialog box.
- j. Click **Next**.
- k. In the Circuit Creation circuit routing preferences dialog box, leave all defaults. Click **Finish**.

Step 4 Confirm that the newly created circuit appears on the Circuits tab list as a two-way circuit.



Note It is normal for the “[CLPBKFACILITY \(OCN\)](#)” [condition on page 2-173](#) to appear during a loopback setup. The condition clears when you remove the loopback.

Step 5 Create the facility loopback on the destination port being tested:

- a. Go to the node view of the destination node:
 - Choose **View > Go To Other Node** from the menu bar.
 - Choose the node from the drop-down list in the Select Node dialog box and click **OK**.
- b. In node view, double-click the card that requires the loopback.
- c. Click the **Maintenance > Loopback > Port** tabs.
- d. Select **OOS,MT** from the Admin State column. If this is a multiport card, select the row appropriate for the desired port.
- e. Select **Facility** from the Loopback Type column. If this is a multiport card, select the row appropriate for the desired port.
- f. Click **Apply**.
- g. Click **Yes** in the confirmation dialog box.

Step 6 Complete the “[Test and Clear the Optical Facility Loopback Circuit](#)” [procedure on page 1-64](#).

Test and Clear the Optical Facility Loopback Circuit

- Step 1** If the test set is not already sending traffic, send test traffic on the loopback circuit.
- Step 2** Examine the traffic received by the test set. Look for errors or any other signal information that the test set is capable of indicating.
- Step 3** If the test set indicates a good circuit, no further testing is necessary with the facility loopback. Clear the facility loopback from the port:
 - a. Click the **Maintenance > Loopback > Port** tabs.
 - b. Choose **None** from the Loopback Type column for the port being tested.
 - c. Choose the appropriate state (**IS; OOS,DSBLD; OOS,MT; IS,AINS**) from the Admin State column for the port being tested.

- d. Click **Apply**.
 - e. Click **Yes** in the confirmation dialog box.
- Step 4** Clear the facility loopback circuit:
- a. Click the **Circuits** tab.
 - b. Choose the loopback circuit being tested.
 - c. Click **Delete**.
 - d. Click **Yes** in the Delete Circuits dialog box. Do not check any check boxes.
- Step 5** Complete the “[Test the Optical Card](#)” procedure on page 1-65.
-

Test the Optical Card

- Step 1** Complete the “[Physically Replace a Traffic Card](#)” procedure on page 2-274 for the suspected bad card and replace it with a known-good one.
- Step 2** Resend test traffic on the loopback circuit with a known-good card installed.
- Step 3** If the test set indicates a good circuit, the problem was probably the defective card. Return the defective card to Cisco through the RMA process. Contact Cisco Technical Support at 1 800 553-2447.
- Step 4** Complete the “[Physically Replace a Traffic Card](#)” procedure on page 2-274 for the faulty card.
- Step 5** Clear the facility loopback on the port:
- a. Click the **Maintenance > Loopback > Port** tabs.
 - b. Choose **None** from the Loopback Type column for the port being tested.
 - c. Choose the appropriate state (**IS; OOS,DSBLD; OOS,MT; IS,AINS**) from the Admin State column for the port being tested.
 - d. Click **Apply**.
 - e. Click **Yes** in the confirmation dialog box.
- Step 6** Clear the facility loopback circuit:
- a. Click the **Circuits** tab.
 - b. Choose the loopback circuit being tested.
 - c. Click **Delete**.
 - d. Click **Yes** in the Delete Circuits dialog box. Do not check any check boxes.
- Step 7** Complete the “[1.4.7 Perform a Terminal Loopback on a Destination-Node Optical Port](#)” procedure on page 1-65.
-

1.4.7 Perform a Terminal Loopback on a Destination-Node Optical Port

The terminal loopback at the destination-node port is the final local hardware error elimination in the circuit troubleshooting process. If this test is completed successfully, you have verified that the circuit is good up to the destination port. The example in [Figure 1-29](#) shows a terminal loopback on an intermediate-node destination OC-N port.

Figure 1-29 Terminal Loopback Path to a Destination-Node OC-N Port

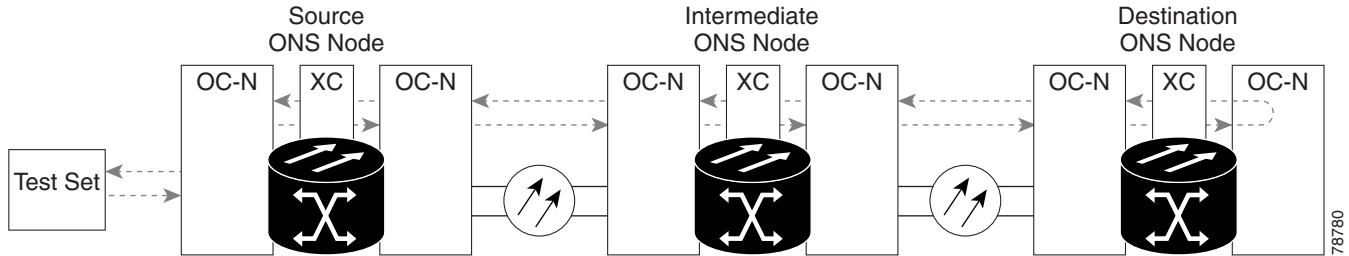
**Caution**

Performing a loopback on an in-service circuit is service-affecting.

**Note**

Terminal loopbacks require on-site personnel.

Complete the [“Create the Terminal Loopback on a Destination-Node Optical Port” procedure on page 1-66](#).

Create the Terminal Loopback on a Destination-Node Optical Port

Step 1 Connect an optical test set to the port you are testing:

**Note**

For specific procedures to connect, set up, and use the test set equipment, consult the manufacturer.

- a. If you just completed the [“1.4.6 Perform a Facility Loopback on a Destination-Node Optical Port” procedure on page 1-63](#), leave the optical test set hooked up to the source port.
- b. If you are starting the current procedure without the optical test set hooked up to the source port, use appropriate cabling to attach the Tx and Rx terminals of the optical test set to the port you are testing. Both Tx and Rx connect to the same port.

Step 2 Adjust the test set accordingly. (Refer to manufacturer instructions for test-set use.)

Step 3 Use CTC to set up the terminal loopback on the test port:

- a. In node view, click the **Circuits** tab and click **Create**.
- b. In the Circuit Creation dialog box, choose the type, such as STS, and number, such as 1.
- c. Click **Next**.
- d. In the next Circuit Creation dialog box, give the circuit an easily identifiable name such as OCN1toOCN6.
- e. Leave the **Bidirectional** check box checked.
- f. Click **Next**.
- g. In the Circuit Creation source dialog box, select the same Node, card Slot, Port, and STS (or VT) where the test set is connected.
- h. Click **Next**.

- i. In the Circuit Creation destination dialog box, use the same Node, card Slot, Port, and STS (or VT) used for the source dialog box.
 - j. Click **Next**.
 - k. In the Circuit Creation circuit routing preferences dialog box, leave all defaults. Click **Finish**.
- Step 4** Confirm that the newly created circuit appears on the Circuits tab list as a two-way circuit.
-  **Note** It is normal for the “[LPBKTERMINAL \(OCN\)](#)” condition on page 2-177 to appear during a loopback setup. The condition clears when you remove the loopback.
- Step 5** Create the terminal loopback on the destination port being tested:
- a. Go to the node view of the destination node:
 - Choose **View > Go To Other Node** from the menu bar.
 - Choose the node from the drop-down list in the Select Node dialog box and click **OK**.
 - b. In node view, double-click the card that requires the loopback.
 - c. Click the **Maintenance > Loopback > Port** tabs.
 - d. Select **OOS,MT** from the Admin State column. If this is a multiport card, select the row appropriate for the desired port.
 - e. Select **Terminal** from the Loopback Type column. If this is a multiport card, select the row appropriate for the desired port.
 - f. Click **Apply**.
 - g. Click **Yes** in the confirmation dialog box.
- Step 6** Complete the “[Test and Clear the Optical Terminal Loopback Circuit](#)” procedure on page 1-67.

Test and Clear the Optical Terminal Loopback Circuit

- Step 1** If the test set is not already sending traffic, send test traffic on the loopback circuit.
- Step 2** Examine the test traffic being received by the test set. Look for errors or any other signal information that the test set is capable of indicating.
- Step 3** If the test set indicates a good circuit, no further testing is necessary on the loopback circuit. Clear the terminal loopback from the port:
- a. Double-click the intermediate-node card with the terminal loopback.
 - b. Click the **Maintenance > Loopback > Port** tabs.
 - c. Select **None** from the Loopback Type column for the port being tested.
 - d. Select the appropriate state (**IS**; **OOS,DSBLD**; **OOS,MT**; **IS,AINS**) in the Admin State column for the port being tested.
 - e. Click **Apply**.
 - f. Click **Yes** in the confirmation dialog box.
- Step 4** Clear the terminal loopback circuit:
- a. Click the **Circuits** tab.

- b. Choose the loopback circuit being tested.
- c. Click **Delete**.
- d. Click **Yes** in the Delete Circuits dialog box. Do not check any check boxes.

The entire circuit path has now passed its comprehensive series of loopback tests. This circuit qualifies to carry live traffic.

Step 5 If the test set indicates a faulty circuit, the problem might be a faulty card.

Step 6 Complete the [“Test the Optical Card” procedure on page 1-68](#).

Test the Optical Card

- Step 1** Complete the [“Physically Replace a Traffic Card” procedure on page 2-274](#) for the suspected bad card and replace it with a known-good card.
- Step 2** Resend test traffic on the loopback circuit with a known-good card.
- Step 3** If the test set indicates a good circuit, the problem was probably the defective card. Return the defective card to Cisco through the RMA process. Contact Cisco Technical Support at 1 800 553-2447.
- Step 4** Complete the [“Physically Replace a Traffic Card” procedure on page 2-274](#) for the defective card.
- Step 5** Clear the terminal loopback on the port:
 - a. Double-click the source-node card with the terminal loopback.
 - b. Click the **Maintenance > Loopback > Port** tabs.
 - c. Select **None** from the Loopback Type column for the port being tested.
 - d. Select the appropriate state (**IS; OOS,DSBLD; OOS,MT; IS,AINS**) in the Admin State column for the port being tested.
 - e. Click **Apply**.
 - f. Click **Yes** in the confirmation dialog box.
- Step 6** Clear the terminal loopback circuit:
 - a. Click the **Circuits** tab.
 - b. Choose the loopback circuit being tested.
 - c. Click **Delete**.
 - d. Click **Yes** in the Delete Circuits dialog box. Do not check any check boxes.

The entire circuit path has now passed its comprehensive series of loopback tests. This circuit qualifies to carry live traffic.

1.5 Troubleshooting Ethernet Circuit Paths With Loopbacks

Facility loopbacks, terminal loopbacks, and cross-connect loopback circuits are often used together to test the circuit path through the network or to logically isolate a fault. Performing a loopback test at each point along the circuit path systematically isolates possible points of failure.

You can use these procedures on G-Series and CE-Series Ethernet cards but not on E-Series or ML-Series Ethernet cards. The example in this section tests a G-Series or CE-Series card circuit on a three-node BLSR. Using a series of facility loopbacks and terminal loopbacks, the example scenario traces the circuit path, tests the possible failure points, and eliminates them. The logical progression contains six network test procedures:

**Note**

The test sequence for your circuits will differ according to the type of circuit and network topology.

1. A facility loopback on the source-node Ethernet port
2. A terminal loopback on the source-node Ethernet port
3. A hairpin on the source-node Ethernet port
4. A facility loopback on the intermediate-node Ethernet port
5. A terminal loopback on the intermediate-node Ethernet port
6. A facility loopback on the destination-node Ethernet port
7. A terminal loopback on the destination-node Ethernet port
8. A hairpin on the destination-node Ethernet port

**Note**

Facility and terminal loopback tests require on-site personnel.

1.5.1 Perform a Facility Loopback on a Source-Node Ethernet Port

The facility loopback test is performed on the node source port in the network circuit. In the testing situation used in this example, the source G-Series port in the source node. Completing a successful facility loopback on this port isolates the G-Series port as a possible failure point. [Figure 1-21](#) shows an example of a facility loopback on a circuit source Ethernet port.

**Note**

Facility loopbacks are not available for Release 4.1 or earlier G-Series cards.

**Note**

Facility loopbacks require on-site personnel.

Figure 1-30 Facility Loopback on a Circuit Source Ethernet Port

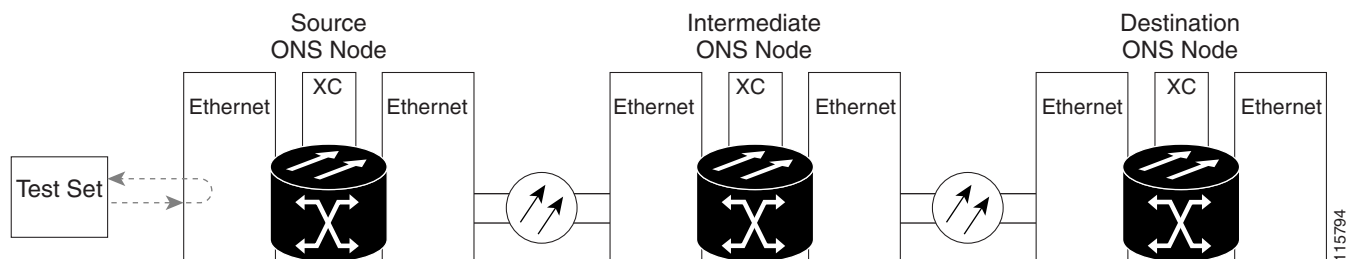

**Caution**

Performing a loopback on an in-service circuit is service-affecting.

Complete the [“Create the Facility Loopback on the Source-Node Ethernet Port”](#) procedure on page 1-70.

Create the Facility Loopback on the Source-Node Ethernet Port

Step 1 Connect an optical test set to the port you are testing.

**Note**

For specific procedures to connect, set up, and use the test set equipment, consult the manufacturer.

Use appropriate cabling to attach the Tx and Rx terminals of the optical test set to the port you are testing. The Tx and Rx terminals connect to the same port.

Step 2 Adjust the test set accordingly. (Refer to manufacturer instructions for test-set use.)

Step 3 In CTC node view, double-click the card to open the card view.

Step 4 Click the **Maintenance > Loopback** tabs.

Step 5 Choose **OOS,MT** from the Admin State column for the port being tested. If this is a multiport card, select the appropriate row for the desired port.

Step 6 Choose **Facility** from the Loopback Type column for the port being tested. If this is a multiport card, select the appropriate row for the desired port.

Step 7 Click **Apply**.

Step 8 Click **Yes** in the confirmation dialog box.

**Note**

It is normal for the [“LPBKFACILITY \(G1000\)”](#) condition on page 2-172 to appear during loopback setup. The condition clears when you remove the loopback.

Step 9 Complete the [“Test and Clear the Facility Loopback Circuit”](#) procedure on page 1-70.

Test and Clear the Facility Loopback Circuit

Step 1 If the test set is not already sending traffic, send test traffic on the loopback circuit.

Step 2 Examine the traffic received by the test set. Look for errors or any other signal information that the test set is capable of indicating.

Step 3 If the test set indicates a good circuit, no further testing is necessary with the facility loopback. Clear the facility loopback:

- a. Click the **Maintenance > Loopback** tabs.
- b. Choose **None** from the Loopback Type column for the port being tested.
- c. Choose the appropriate state (IS; OOS,DSBLD; OOS,MT) from the Admin State column for the port being tested.

- d. Click **Apply**.
 - e. Click **Yes** in the confirmation dialog box.
- Step 4** Complete the “[Test the Ethernet Card](#)” procedure on page 1-71.
-

Test the Ethernet Card

- Step 1** Complete the “[Physically Replace a Traffic Card](#)” procedure on page 2-274 for the suspected bad card and replace it with a known-good one.
- Step 2** Resend test traffic on the loopback circuit with a known-good card installed.
- Step 3** If the test set indicates a good circuit, the problem was probably the defective card. Return the defective card to Cisco through the RMA process. Contact Cisco Technical Support at 1 800 553-2447.
- Step 4** Complete the “[Physically Replace a Traffic Card](#)” procedure on page 2-274 for the faulty card.
- Step 5** Clear the facility loopback:
- a. Click the **Maintenance > Loopback** tabs.
 - b. Choose **None** from the Loopback Type column for the port being tested.
 - c. Choose the appropriate state (IS; OOS,DSBLD; OOS,MT) from the Admin State column for the port being tested.
 - d. Click **Apply**.
 - e. Click **Yes** in the confirmation dialog box.
- Step 6** Complete the “[1.5.2 Perform a Terminal Loopback on a Source-Node Ethernet Port](#)” procedure on page 1-71.
-

1.5.2 Perform a Terminal Loopback on a Source-Node Ethernet Port

The terminal loopback test is performed on the node source Ethernet port. For the circuit in this example, it is the source G-Series port in the source node. You first create a bidirectional circuit that starts on the node destination G-Series port and loops back on the node source G-Series port. You then proceed with the terminal loopback test. Completing a successful terminal loopback to a node source port verifies that the circuit is good to the source port. [Figure 1-31](#) shows terminal loopback on a G-Series port.



Note Terminal loopbacks are not available for R4.0 and earlier G-Series cards.



Note Terminal loopbacks require on-site personnel.

Figure 1-31 Terminal Loopback on a G-Series Port

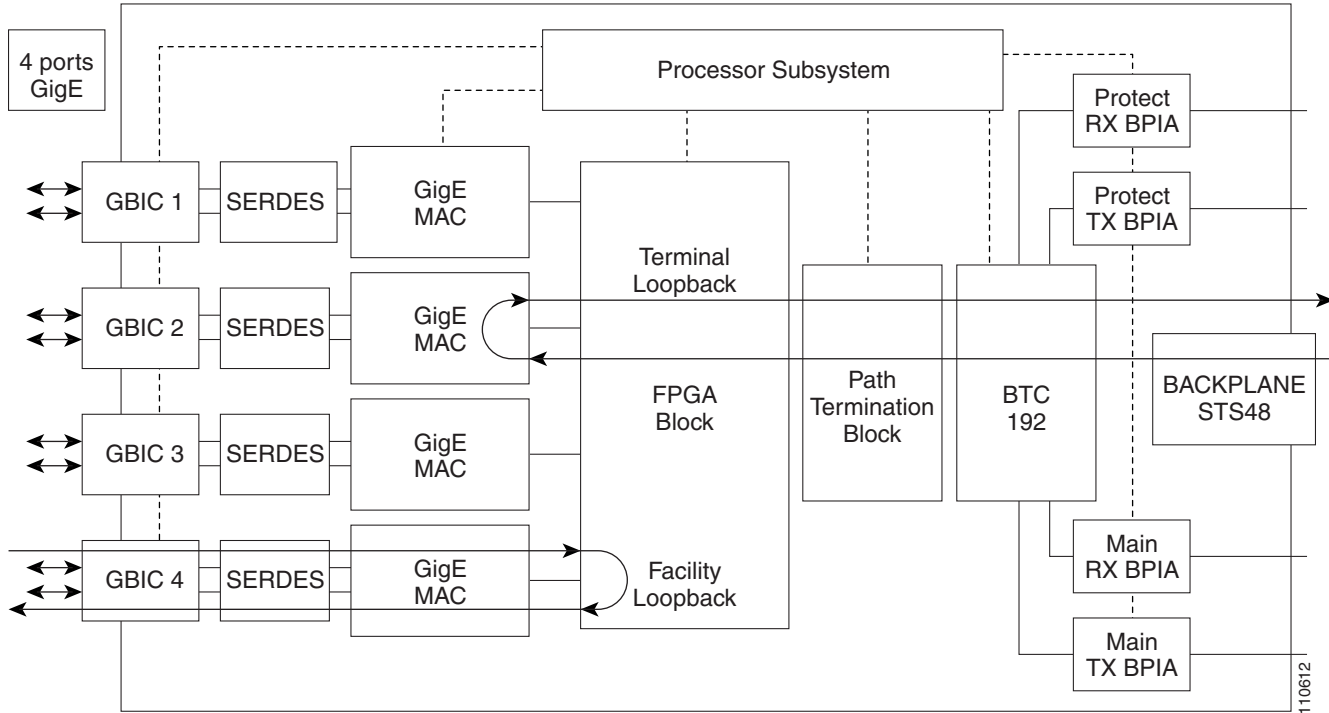
**Caution**

Performing a loopback on an in-service circuit is service-affecting.

Complete the [“Create the Terminal Loopback on a Source-Node Ethernet Port”](#) procedure on page 1-72.

Create the Terminal Loopback on a Source-Node Ethernet Port

Step 1 Connect an optical test set to the port you are testing:

**Note**

For specific procedures to connect, set up, and use the test set equipment, consult the manufacturer.

- a. If you just completed the [“1.5.1 Perform a Facility Loopback on a Source-Node Ethernet Port”](#) procedure on page 1-69, leave the optical test set hooked up to the Ethernet port in the source node.
- b. If you are starting the current procedure without the optical test set hooked up to the source port, use appropriate cabling to attach the Tx and Rx terminals of the optical test set to the port you are testing. Both Tx and Rx connect to the same port.

Step 2 Adjust the test set accordingly. (Refer to manufacturer instructions for test-set use.)

Step 3 Use CTC to set up the terminal loopback on the test port:

- a. In node view, click the **Circuits** tab and click **Create**.
- b. In the Circuit Creation dialog box, choose the type, such as STS, and number, such as 1.
- c. Click **Next**.

- d. In the next Circuit Creation dialog box, give the circuit an easily identifiable name such as G1K1toG1K2.
- e. Leave the **Bidirectional** check box checked.
- f. Click **Next**.
- g. In the Circuit Creation source dialog box, select the same Node, card Slot, Port, and STS (or VT) where the test set is connected.
- h. Click **Next**.
- i. In the Circuit Creation destination dialog box, use the same Node, card Slot, Port, and STS (or VT) used for the source dialog box.
- j. Click **Next**.
- k. In the Circuit Creation circuit routing preferences dialog box, leave all defaults. Click **Finish**.

Step 4 Confirm that the newly created circuit appears on the Circuits tab list as a two-way circuit.



Note It is normal for the [“LPBKTERMINAL \(G1000\)” condition on page 2-177](#) to appear during a loopback setup. The condition clears when you remove the loopback.

Step 5 Create the terminal loopback on the destination port being tested:

- a. In node view, double-click the card that requires the loopback, such as the destination G-Series card in the source node.
- b. Click the **Maintenance > Loopback** tabs.
- c. Select **OOS,MT** from the Admin State column. If this is a multiport card, select the row appropriate for the desired port.
- d. Select **Terminal** from the Loopback Type column. If this is a multiport card, select the row appropriate for the desired port.
- e. Click **Apply**.
- f. Click **Yes** in the confirmation dialog box.

Step 6 Complete the [“Test and Clear the Ethernet Terminal Loopback Circuit” procedure on page 1-73](#).

Test and Clear the Ethernet Terminal Loopback Circuit

- Step 1** If the test set is not already sending traffic, send test traffic on the loopback circuit.
- Step 2** Examine the test traffic being received by the test set. Look for errors or any other signal information that the test set is capable of indicating.
- Step 3** If the test set indicates a good circuit, no further testing is necessary on the loopback circuit. Clear the terminal loopback state on the port:
 - a. Double-click the card in the source node with the terminal loopback.
 - b. Click the **Maintenance > Loopback** tabs.
 - c. Select **None** from the Loopback Type column for the port being tested.
 - d. Select the appropriate state (IS; OOS,DSBLD; OOS,MT) in the Admin State column for the port being tested.

- e. Click **Apply**.
 - f. Click **Yes** in the confirmation dialog box.
- Step 4** Clear the terminal loopback circuit:
- a. Click the **Circuits** tab.
 - b. Choose the loopback circuit being tested.
 - c. Click **Delete**.
 - d. Click **Yes** in the Delete Circuits dialog box. Do not check any check boxes.
- Step 5** Complete the “[Test the Ethernet Card](#)” procedure on page 1-74.
-

Test the Ethernet Card

- Step 1** Complete the “[Physically Replace a Traffic Card](#)” procedure on page 2-274 for the suspected bad card and replace it with a known-good one.
- Step 2** Resend test traffic on the loopback circuit with a known-good card.
- Step 3** If the test set indicates a good circuit, the problem was probably the defective card. Return the defective card to Cisco through the RMA process. Contact Cisco Technical Support at 1 800 553-2447.
- Step 4** Complete the “[Physically Replace a Traffic Card](#)” procedure on page 2-274 for the defective card.
- Step 5** Clear the terminal loopback on the port before testing the next segment of the network circuit path:
- a. Double-click the card in the source node with the terminal loopback.
 - b. Click the **Maintenance > Loopback** tabs.
 - c. Select **None** from the Loopback Type column for the port being tested.
 - d. Select the appropriate state (IS; OOS,DSBLD; OOS,MT) in the Admin State column for the port being tested.
 - e. Click **Apply**.
 - f. Click **Yes** in the confirmation dialog box.
- Step 6** Clear the terminal loopback circuit before testing the next segment of the network circuit path:
- a. Click the **Circuits** tab.
 - b. Choose the loopback circuit being tested.
 - c. Click **Delete**.
 - d. Click **Yes** in the Delete Circuits dialog box. Do not check any check boxes.
- Step 7** Complete the “[1.5.3 Perform a Hairpin Test on a Source-Node Ethernet Port](#)” procedure on page 1-75.
-

1.5.3 Perform a Hairpin Test on a Source-Node Ethernet Port

The hairpin test is performed on the cross-connect card in the network circuit. A hairpin circuit uses the same port for both source and destination. Completing a successful hairpin through the port isolates the possibility that the cross-connect card is the cause of the faulty circuit. [Figure 1-32](#) shows an example of a hairpin loopback on a source-node port.

Figure 1-32 Hairpin on a Source-Node Ethernet Port

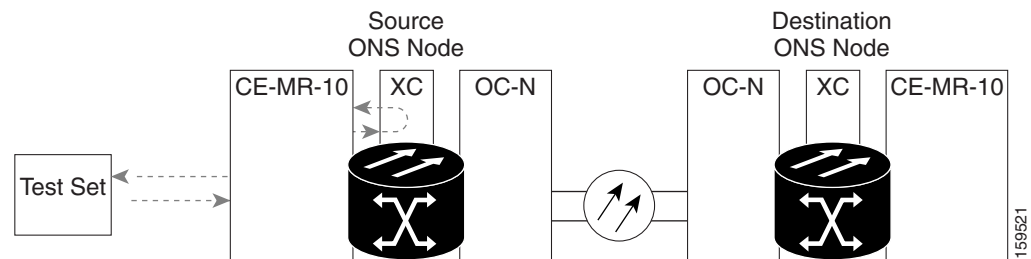

Note

The ONS 15454 does not support simplex operation on the cross-connect card. Two cross-connect cards of the same type must be installed for each node.



Note

Hairpin loopbacks require on-site personnel.

Complete the [“Create the Hairpin Circuit on the Source-Node Ethernet Port”](#) procedure on page 1-75.

Create the Hairpin Circuit on the Source-Node Ethernet Port

- Step 1** Connect an Ethernet test set to the port you are testing:
- If you just completed the [“1.5.2 Perform a Terminal Loopback on a Source-Node Ethernet Port”](#) procedure on page 1-71, leave the Ethernet test set hooked up to the Ethernet port in the source node.
 - If you are starting the current procedure without the Ethernet test set hooked up to the Ethernet port, use appropriate cabling to connect the Ethernet test set to the port you are testing.
- Step 2** Adjust the test set accordingly. (Refer to manufacturer instructions for test-set use.)
- Step 3** Use CTC to set up the hairpin circuit on the test port:
- In node view, click the **Circuits** tab and click **Create**.
 - In the Circuit Creation dialog box, choose the type, such as STS, and number, such as 1.
 - Click **Next**.
 - In the next Circuit Creation dialog box, give the circuit an easily identifiable name such as Hairpin1.
 - Choose the Size, such as STS-1.
 - Uncheck the **Bidirectional** check box. Leave the default values for State, SD Threshold, and SF Threshold.
 - Click **Next**.

1.5.3 Perform a Hairpin Test on a Source-Node Ethernet Port

- h. In the Circuit Creation source dialog box, select the same Node, card Slot, Port, and STS (or VT) where the test set is connected. Leave Use Secondary Source unchecked.
 - i. Click **Next**.
 - j. In the Circuit Creation destination dialog box, use the same Node, card Slot, Port, and STS (or VT) used for the source dialog box. Leave Use Secondary Destination unchecked.
 - k. Click **Next**.
 - l. In the Circuit Creation circuit routing preferences dialog box, leave all defaults. Click **Finish**.
- Step 4** Confirm that the newly created circuit appears on the Circuits tab and that the Dir column describes it as a one-way circuit.
- Step 5** Complete the [“Test and Delete the Ethernet Port Hairpin Circuit” procedure on page 1-76](#).
-

Test and Delete the Ethernet Port Hairpin Circuit

- Step 1** If the test set is not already sending traffic, send test traffic on the loopback circuit.
- Step 2** Examine the test traffic received by the test set. Look for errors or any other signal information that the test set is capable of indicating.
- Step 3** If the test set indicates a good circuit, no further testing is necessary with the hairpin circuit. Clear the hairpin circuit:
- a. Click the **Circuits** tab.
 - b. Choose the hairpin circuit being tested.
 - c. Click **Delete**.
 - d. Click **Yes** in the Delete Circuits dialog box. Do not check any check boxes.
 - e. Confirm that the hairpin circuit is deleted from the Circuits tab list.
- Step 4** Complete the [“Test the Standby Cross-Connect Card” procedure on page 1-76](#).
-

Test the Standby Cross-Connect Card



Note Two cross-connect cards (active and standby) must be in use on a node to use this procedure.

- Step 1** Perform a reset on the standby cross-connect card to make it the active card:
- a. Determine the standby cross-connect card. On both the physical node and the CTC node view window, the standby cross-connect ACT/SBY LED is amber and the active card ACT/SBY LED is green.
 - b. Position the cursor over the standby cross-connect card.
 - c. Right-click and choose **RESET CARD**.
 - d. Click **Yes** in the confirmation dialog box.
- Step 2** Initiate an external switching command (side switch) on the cross-connect cards before you retest the loopback circuit:

**Caution**

Cross-connect side switches, with the exception of side switches using XC-VXC-10G cards, are service-affecting. Any live traffic on any card in the node endures a hit of up to 50 ms. XC-VXC-10G side switches are errorless.

- a. Determine the standby cross-connect card. On both the physical node and the CTC node view window, the standby cross-connect ACT/SBY LED is amber and the active card ACT/SBY LED is green.
- b. In the node view, select the **Maintenance > Cross-Connect > Cards** tabs.
- c. In the Cross-Connect Cards area, click **Switch**.
- d. Click **Yes** in the Confirm Switch dialog box.

**Note**

After the active cross-connect goes into standby mode, the original standby card becomes active and its ACT/SBY LED turns green. The former active card becomes standby and its ACT/SBY LED turns amber.

Step 3 Resend test traffic on the loopback circuit.

The test traffic now travels through the alternate cross-connect card.

Step 4 If the test set indicates a faulty circuit, assume the cross-connect card is not causing the problem. Clear the hairpin circuit:

- a. Click the **Circuits** tab.
- b. Choose the hairpin circuit being tested.
- c. Click **Delete**.
- d. Click **Yes** in the Delete Circuits dialog box. Do not check any check boxes.
- e. Confirm that the hairpin circuit is deleted from the Circuits tab list.

Step 5 To confirm a defective original cross-connect card, complete the [“Retest the Original Cross-Connect Card” procedure on page 1-77](#).

Retest the Original Cross-Connect Card

Step 1 Initiate an external switching command (side switch) on the cross-connect cards:

- a. Determine the standby cross-connect card. On both the physical node and the CTC node view window, the standby cross-connect ACT/SBY LED is amber and the active card ACT/SBY LED is green.
- b. In node view, select the **Maintenance > Cross-Connect > Cards** tabs.
- c. From the Cross-Connect Cards menu, choose **Switch**.
- d. Click **Yes** in the Confirm Switch dialog box.

**Note**

After the active cross-connect goes into standby mode, the original standby card becomes active and its ACT/SBY LED turns green. The former active card becomes standby and its ACT/SBY LED turns amber.

- Step 2** Resend test traffic on the loopback circuit.
- Step 3** If the test set indicates a faulty circuit, the problem is probably the defective card. Return the defective card to Cisco through the RMA process. Contact Cisco Technical Support at 1 800 553-2447 and proceed to Step 4. If the test does not indicate a faulty circuit, proceed to Step 5.
- Step 4** Complete the [“Physically Replace an In-Service Cross-Connect Card” procedure on page 2-274](#) for the defective card.
- Step 5** If the test set indicates a good circuit, the cross-connect card might have had a temporary problem that was cleared by the side switch. Clear the hairpin circuit:
- Click the **Circuits** tab.
 - Choose the hairpin circuit being tested.
 - Click **Delete**.
 - Click **Yes** in the Delete Circuits dialog box. Do not check any check boxes.
 - Confirm that the hairpin circuit is deleted from the Circuits tab list.
- Step 6** Complete the [“1.5.4 Create a Facility Loopback on an Intermediate-Node Ethernet Port” procedure on page 1-78](#).

1.5.4 Create a Facility Loopback on an Intermediate-Node Ethernet Port

Performing the facility loopback test on an intermediate port isolates whether this node is causing circuit failure. It is shown in [Figure 1-33](#).

Figure 1-33 Facility Loopback on an Intermediate-Node Ethernet Port

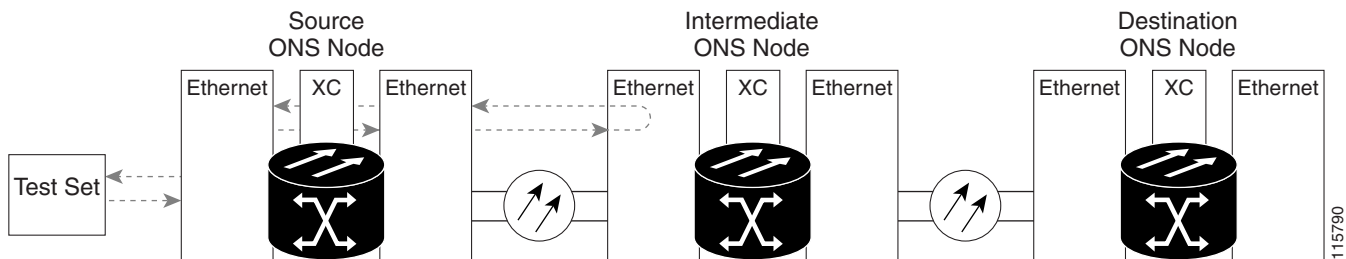

Caution

Performing a loopback on an in-service circuit is service-affecting.



Note

Facility loopbacks require on-site personnel.

Complete the [“Create a Facility Loopback on an Intermediate-Node Ethernet Port” procedure on page 1-79](#).

Create a Facility Loopback on an Intermediate-Node Ethernet Port

Step 1 Connect an optical test set to the port you are testing:



Note For specific procedures to connect, set up, and use the test set equipment, consult the manufacturer.

- a. If you just completed the [“1.5.2 Perform a Terminal Loopback on a Source-Node Ethernet Port” procedure on page 1-71](#), leave the optical test set hooked up to the source-node port.
- b. If you are starting the current procedure without the optical test set hooked up to the source port, use appropriate cabling to attach the Tx and Rx terminals of the optical test set to the port you are testing. Both Tx and Rx connect to the same port.

Step 2 Adjust the test set accordingly. (Refer to manufacturer instructions for test-set use.)

Step 3 Use CTC to set up the facility loopback on the test port:

- a. In node view, click the **Circuits** tab and click **Create**.
- b. In the Circuit Creation dialog box, choose the type, such as STS, and number, such as 1.
- c. Click **Next**.
- d. In the next Circuit Creation dialog box, give the circuit an easily identifiable name such as G1KtoG1K3.
- e. Leave the **Bidirectional** check box checked.
- f. Click **Next**.
- g. In the Circuit Creation source dialog box, select the same Node, card Slot, Port, and STS (or VT) where the test set is connected.
- h. Click **Next**.
- i. In the Circuit Creation destination dialog box, use the same Node, card Slot, Port, and STS (or VT) used for the source dialog box.
- j. Click **Next**.
- k. In the Circuit Creation circuit routing preferences dialog box, leave all defaults. Click **Finish**.

Step 4 Confirm that the newly created circuit appears on the Circuits tab list as a two-way circuit.



Note It is normal for the [“LPBKFACILITY \(G1000\)” condition on page 2-172](#) or the [“CLPBKFACILITY \(OCN\)” condition on page 2-173](#) to appear during a loopback setup. The condition clears when you remove the loopback.

Step 5 Create the facility loopback on the destination port being tested:

- a. Go to the node view of the intermediate node:
 - Choose **View > Go To Other Node** from the menu bar.
 - Choose the node from the drop-down list in the Select Node dialog box and click **OK**.
- b. In node view, double-click the intermediate-node card that requires the loopback.
- c. Click the **Maintenance > Loopback** tabs.

1.5.4 Create a Facility Loopback on an Intermediate-Node Ethernet Port

- d. Select **OOS,MT** from the Admin State column. If this is a multiport card, select the row appropriate for the desired port.
- e. Select **Facility** from the Loopback Type column. If this is a multiport card, select the row appropriate for the desired port.
- f. Click **Apply**.
- g. Click **Yes** in the confirmation dialog box.

Step 6 Complete the [“Test and Clear the Ethernet Facility Loopback Circuit” procedure on page 1-80](#).

Test and Clear the Ethernet Facility Loopback Circuit

- Step 1** If the test set is not already sending traffic, send test traffic on the loopback circuit.
 - Step 2** Examine the traffic received by the test set. Look for errors or any other signal information that the test set is capable of indicating.
 - Step 3** If the test set indicates a good circuit, no further testing is necessary with the facility loopback. Clear the facility loopback from the port:
 - a. Click the **Maintenance > Loopback** tabs.
 - b. Choose **None** from the Loopback Type column for the port being tested.
 - c. Choose the appropriate state (IS; OOS,DSBLD; OOS,MT) from the Admin State column for the port being tested.
 - d. Click **Apply**.
 - e. Click **Yes** in the confirmation dialog box.
 - Step 4** Clear the facility loopback circuit:
 - a. Click the **Circuits** tab.
 - b. Choose the loopback circuit being tested.
 - c. Click **Delete**.
 - d. Click **Yes** in the Delete Circuits dialog box. Do not check any check boxes.
 - Step 5** Complete the [“Test the Ethernet Card” procedure on page 1-80](#).
-

Test the Ethernet Card

- Step 1** Complete the [“Physically Replace a Traffic Card” procedure on page 2-274](#) for the suspected bad card and replace it with a known-good one.
- Step 2** Resend test traffic on the loopback circuit with a known-good card installed.
- Step 3** If the test set indicates a good circuit, the problem was probably the defective card. Return the defective card to Cisco through the RMA process. Contact Cisco Technical Support at 1 800 553-2447.
- Step 4** Complete the [“Physically Replace a Traffic Card” procedure on page 2-274](#) for the faulty card.
- Step 5** Clear the facility loopback from the port:
 - a. Click the **Maintenance > Loopback** tabs.

- b. Choose **None** from the Loopback Type column for the port being tested.
 - c. Choose the appropriate state (IS; OOS,DSBLD; OOS,MT) from the Admin State column for the port being tested.
 - d. Click **Apply**.
 - e. Click **Yes** in the confirmation dialog box.
- Step 6** Clear the facility loopback circuit:
- a. Click the **Circuits** tab.
 - b. Choose the loopback circuit being tested.
 - c. Click **Delete**.
 - d. Click **Yes** in the Delete Circuits dialog box. Do not check any check boxes.
- Step 7** Complete the “[1.5.5 Create a Terminal Loopback on Intermediate-Node Ethernet Ports](#)” procedure on page 1-81.

1.5.5 Create a Terminal Loopback on Intermediate-Node Ethernet Ports

In the next troubleshooting test, you perform a terminal loopback on the intermediate-node port to isolate whether the destination port is causing circuit trouble. In the example situation in [Figure 1-34](#), the terminal loopback is performed on an intermediate Ethernet port in the circuit. You first create a bidirectional circuit that originates on the source-node Ethernet port and loops back on the intermediate-node port. You then proceed with the terminal loopback test. If you successfully complete a terminal loopback on the node, this node is excluded from possible sources of circuit trouble.

Figure 1-34 Terminal Loopback on an Intermediate-Node Ethernet Port

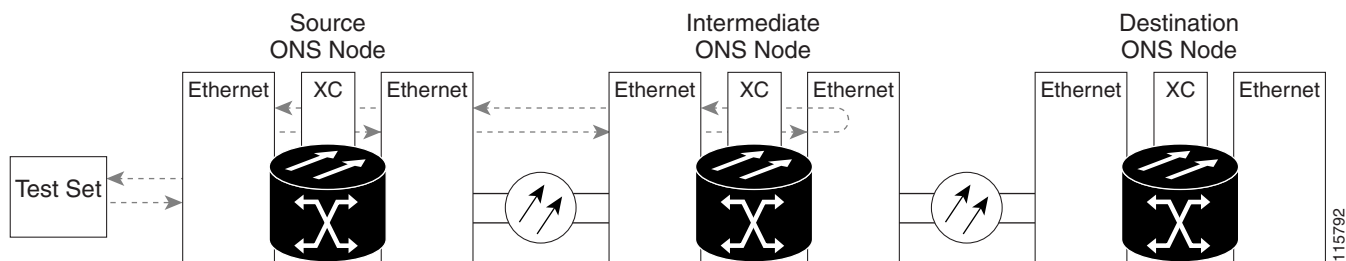

Caution

Performing a loopback on an in-service circuit is service-affecting.



Note

Terminal loopbacks require on-site personnel.

Complete the “[Create a Terminal Loopback on Intermediate-Node Ethernet Ports](#)” procedure on page 1-82.

Create a Terminal Loopback on Intermediate-Node Ethernet Ports

Step 1 Connect an optical test set to the port you are testing:



Note For specific procedures to connect, set up, and use the test set equipment, consult the manufacturer.

- a. If you just completed the [“1.5.4 Create a Facility Loopback on an Intermediate-Node Ethernet Port” procedure on page 1-78](#) for the Ethernet circuit, leave the optical test set hooked up to the intermediate-node port.
- b. If you are starting the current procedure without the optical test set hooked up to the source port, use appropriate cabling to attach the Tx and Rx terminals of the optical test set to the port you are testing. Both Tx and Rx connect to the same port.

Step 2 Adjust the test set accordingly. (Refer to manufacturer instructions for test-set use.)

Step 3 Use CTC to set up the terminal loopback on the test port:

- a. In node view, click the **Circuits** tab and click **Create**.
- b. In the Circuit Creation dialog box, choose the type, such as STS, and number, such as 1.
- c. Click **Next**.
- d. In the next Circuit Creation dialog box, give the circuit an easily identifiable name such as G1K1toG1K4.
- e. Leave the **Bidirectional** check box checked.
- f. Click **Next**.
- g. In the Circuit Creation source dialog box, select the same Node, card Slot, Port, and STS (or VT) where the test set is connected.
- h. Click **Next**.
- i. In the Circuit Creation destination dialog box, use the same Node, card Slot, Port, and STS (or VT) used for the source dialog box.
- j. Click **Next**.
- k. In the Circuit Creation circuit routing preferences dialog box, leave all defaults. Click **Finish**.

Step 4 Confirm that the newly created circuit appears on the Circuits tab list and that it is described in the Dir column as a two-way circuit.



Note It is normal for the [“LPBKTERMINAL \(G1000\)” condition on page 2-177](#) to appear during a loopback setup. The condition clears when you remove the loopback.

Step 5 Create the terminal loopback on the destination port being tested:

- a. Go to the node view of the intermediate node:
 - Choose **View > Go To Other Node** from the menu bar.
 - Choose the node from the drop-down list in the Select Node dialog box and click **OK**.
- b. In node view, double-click the card that requires the loopback.
- c. Click the **Maintenance > Loopback** tabs.

- d. Select **OOS,MT** from the Admin State column. If this is a multiport card, select the row appropriate for the desired port.
 - e. Select **Terminal** from the Loopback Type column. If this is a multiport card, select the row appropriate for the desired port.
 - f. Click **Apply**.
 - g. Click **Yes** in the confirmation dialog box.
- Step 6** Complete the [“Test and Clear the Ethernet Terminal Loopback Circuit” procedure on page 1-83](#).
-

Test and Clear the Ethernet Terminal Loopback Circuit

- Step 1** If the test set is not already sending traffic, send test traffic on the loopback circuit.
- Step 2** Examine the test traffic being received by the test set. Look for errors or any other signal information that the test set is capable of indicating.
- Step 3** If the test set indicates a good circuit, no further testing is necessary on the loopback circuit. Clear the terminal loopback from the port:
- a. Double-click the intermediate-node card with the terminal loopback to open the card view.
 - b. Click the **Maintenance > Loopback** tabs.
 - c. Select **None** from the Loopback Type column for the port being tested.
 - d. Select the appropriate state (IS; OOS,DSBLD; OOS,MT) in the Admin State column for the port being tested.
 - e. Click **Apply**.
 - f. Click **Yes** in the confirmation dialog box.
- Step 4** Clear the terminal loopback circuit:
- a. Click the **Circuits** tab.
 - b. Choose the loopback circuit being tested.
 - c. Click **Delete**.
 - d. Click **Yes** in the Delete Circuits dialog box. Do not check any check boxes.
- Step 5** Complete the [“Test the Ethernet Card” procedure on page 1-83](#).
-

Test the Ethernet Card

- Step 1** Complete the [“Physically Replace a Traffic Card” procedure on page 2-274](#) for the suspected bad card and replace it with a known-good one.
- Step 2** Resend test traffic on the loopback circuit with a known-good card.
- Step 3** If the test set indicates a good circuit, the problem was probably the defective card. Return the defective card to Cisco through the RMA process. Contact Cisco Technical Support at 1 800 553-2447.
- Step 4** Complete the [“Physically Replace a Traffic Card” procedure on page 2-274](#) for the defective card.

- Step 5** Clear the terminal loopback on the port:
- Double-click the source-node card with the terminal loopback.
 - Click the **Maintenance > Loopback** tabs.
 - Select **None** from the Loopback Type column for the port being tested.
 - Select the appropriate state (IS; OOS,DSBLD; OOS,MT) in the Admin State column for the port being tested.
 - Click **Apply**.
 - Click **Yes** in the confirmation dialog box.
- Step 6** Clear the terminal loopback circuit:
- Click the **Circuits** tab.
 - Choose the loopback circuit being tested.
 - Click **Delete**.
 - Click **Yes** in the Delete Circuits dialog box. Do not check any check boxes.
- Step 7** Complete the “1.5.6 Perform a Facility Loopback on a Destination-Node Ethernet Port” procedure on page 1-84.

1.5.6 Perform a Facility Loopback on a Destination-Node Ethernet Port

You perform a facility loopback test at the destination port to determine whether this local port is the source of circuit trouble. The example in [Figure 1-35](#) shows a facility loopback being performed on an Ethernet port.

Figure 1-35 Facility Loopback on a Destination-Node Ethernet Port

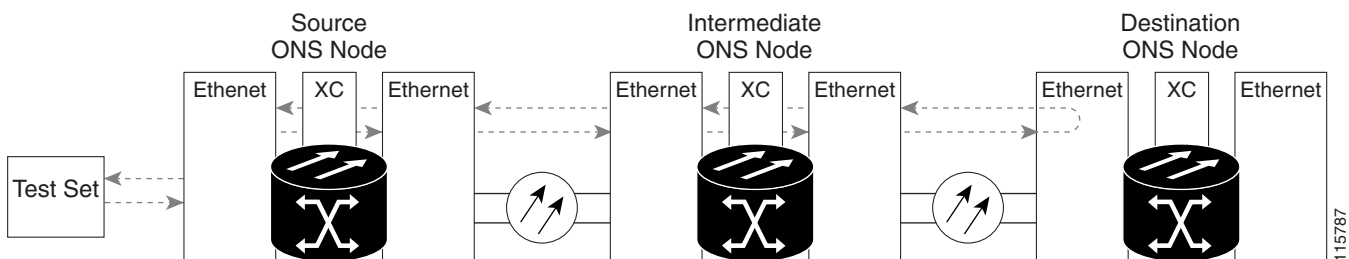

Caution Performing a loopback on an in-service circuit is service-affecting.



Note Facility loopbacks require on-site personnel.

Complete the “[Create the Facility Loopback on a Destination-Node Ethernet Port](#)” procedure on page 1-85.

Create the Facility Loopback on a Destination-Node Ethernet Port

Step 1 Connect an optical test set to the port you are testing:



Note For specific procedures to connect, set up, and use the test set equipment, consult the manufacturer.

- a. If you just completed the [“1.5.5 Create a Terminal Loopback on Intermediate-Node Ethernet Ports” section on page 1-81](#), leave the optical test set hooked up to the source-node port.
- b. If you are starting the current procedure without the optical test set hooked up to the source port, use appropriate cabling to attach the Tx and Rx terminals of the optical test set to the port you are testing. Both Tx and Rx connect to the same port.

Step 2 Adjust the test set accordingly. (Refer to manufacturer instructions for test-set use.)

Step 3 Use CTC to set up the hairpin circuit on the test port:

- a. In node view, click the **Circuits** tab and click **Create**.
- b. In the Circuit Creation dialog box, choose the type, such as STS, and number, such as 1.
- c. Click **Next**.
- d. In the next Circuit Creation dialog box, give the circuit an easily identifiable name such as G1K1toG1K5.
- e. Leave the **Bidirectional** check box checked.
- f. Click **Next**.
- g. In the Circuit Creation source dialog box, select the same Node, card Slot, Port, and STS (or VT) where the test set is connected.
- h. Click **Next**.
- i. In the Circuit Creation destination dialog box, use the same Node, card Slot, Port, and STS (or VT) used for the source dialog box.
- j. Click **Next**.
- k. In the Circuit Creation circuit routing preferences dialog box, leave all defaults. Click **Finish**.

Step 4 Confirm that the newly created circuit appears on the Circuits tab list as a two-way circuit.



Note It is normal for the [“LPBKFACILITY \(G1000\)” condition on page 2-172](#) to appear during a loopback setup. The condition clears when you remove the loopback.

Step 5 Create the facility loopback on the destination port being tested:

- a. Go to the node view of the destination node:
 - Choose **View > Go To Other Node** from the menu bar.
 - Choose the node from the drop-down list in the Select Node dialog box and click **OK**.
- b. In node view, double-click the card that requires the loopback.
- c. Click the **Maintenance > Loopback** tabs.
- d. Select **OOS,MT** from the Admin State column. If this is a multiport card, select the row appropriate for the desired port.

- e. Select **Facility** from the Loopback Type column. If this is a multiport card, select the row appropriate for the desired port.
- f. Click **Apply**.
- g. Click **Yes** in the confirmation dialog box.

Step 6 Complete the [“Test and Clear the Ethernet Facility Loopback Circuit” procedure on page 1-86](#).

Test and Clear the Ethernet Facility Loopback Circuit

- Step 1** If the test set is not already sending traffic, send test traffic on the loopback circuit.
- Step 2** Examine the traffic received by the test set. Look for errors or any other signal information that the test set is capable of indicating.
- Step 3** If the test set indicates a good circuit, no further testing is necessary with the facility loopback. Clear the facility loopback from the port:
- a. Click the **Maintenance > Loopback** tabs.
 - b. Choose **None** from the Loopback Type column for the port being tested.
 - c. Choose the appropriate state (IS; OOS,DSBLD; OOS,MT) from the Admin State column for the port being tested.
 - d. Click **Apply**.
 - e. Click **Yes** in the confirmation dialog box.
- Step 4** Clear the facility loopback circuit:
- a. Click the **Circuits** tab.
 - b. Choose the loopback circuit being tested.
 - c. Click **Delete**.
 - d. Click **Yes** in the Delete Circuits dialog box. Do not check any check boxes.
- Step 5** Complete the [“Test the Ethernet Card” procedure on page 1-86](#).
-

Test the Ethernet Card

- Step 1** Complete the [“Physically Replace a Traffic Card” procedure on page 2-274](#) for the suspected bad card and replace it with a known-good one.
- Step 2** Resend test traffic on the loopback circuit with a known-good card installed.
- Step 3** If the test set indicates a good circuit, the problem was probably the defective card. Return the defective card to Cisco through the RMA process. Contact Cisco Technical Support at 1 800 553-2447.
- Step 4** Complete the [“Physically Replace a Traffic Card” procedure on page 2-274](#) for the faulty card.
- Step 5** Clear the facility loopback on the port:
- a. Click the **Maintenance > Loopback** tabs.
 - b. Choose **None** from the Loopback Type column for the port being tested.

- c. Choose the appropriate state (IS; OOS,DSBLD; OOS,MT) from the Admin State column for the port being tested.
 - d. Click **Apply**.
 - e. Click **Yes** in the confirmation dialog box.
- Step 6** Clear the facility loopback circuit:
- a. Click the **Circuits** tab.
 - b. Choose the loopback circuit being tested.
 - c. Click **Delete**.
 - d. Click **Yes** in the Delete Circuits dialog box. Do not check any check boxes.
- Step 7** Complete the “[1.5.7 Perform a Terminal Loopback on a Destination-Node Ethernet Port](#)” procedure on page 1-87.

1.5.7 Perform a Terminal Loopback on a Destination-Node Ethernet Port

The terminal loopback at the destination-node port is the final local hardware error elimination in the circuit troubleshooting process. If this test is completed successfully, you have verified that the circuit is good up to the destination port. The example in [Figure 1-29](#) shows a terminal loopback on an intermediate-node destination Ethernet port.

Figure 1-36 Terminal Loopback on a Destination-Node Ethernet Port

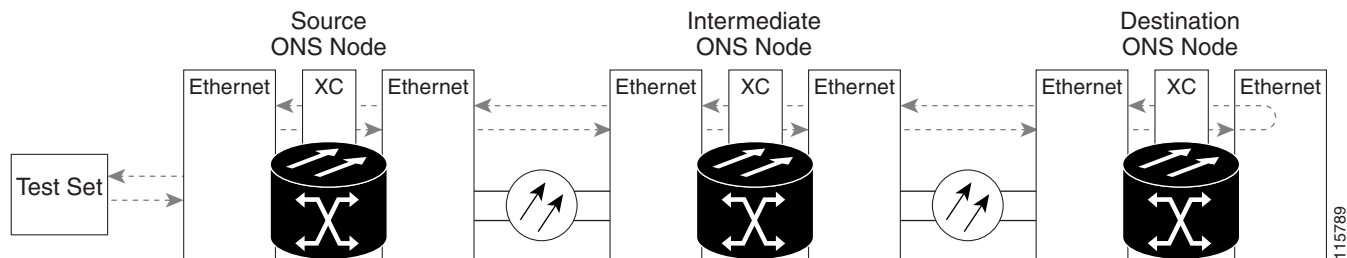

Caution

Performing a loopback on an in-service circuit is service-affecting.



Note

Terminal loopbacks require on-site personnel.

Complete the “[Create the Terminal Loopback on a Destination-Node Ethernet Port](#)” procedure on page 1-87.

Create the Terminal Loopback on a Destination-Node Ethernet Port

- Step 1** Connect an optical test set to the port you are testing:



Note For specific procedures to connect, set up, and use the test set equipment, consult the manufacturer.

- a. If you just completed the “[1.5.6 Perform a Facility Loopback on a Destination-Node Ethernet Port](#)” procedure on page 1-84, leave the optical test set hooked up to the source port.
- b. If you are starting the current procedure without the optical test set hooked up to the source port, use appropriate cabling to attach the Tx and Rx terminals of the optical test set to the port you are testing. Both Tx and Rx connect to the same port.

Step 2 Adjust the test set accordingly. (Refer to manufacturer instructions for test-set use.)

Step 3 Use CTC to set up the terminal loopback on the test port:

- a. In node view, click the **Circuits** tab and click **Create**.
- b. In the Circuit Creation dialog box, choose the type, such as STS, and number, such as 1.
- c. Click **Next**.
- d. In the next Circuit Creation dialog box, give the circuit an easily identifiable name such as G1K1toG1K6.
- e. Leave the **Bidirectional** check box checked.
- f. Click **Next**.
- g. In the Circuit Creation source dialog box, select the same Node, card Slot, Port, and STS (or VT) where the test set is connected.
- h. Click **Next**.
- i. In the Circuit Creation destination dialog box, use the same Node, card Slot, Port, and STS (or VT) used for the source dialog box.
- j. Click **Next**.
- k. In the Circuit Creation circuit routing preferences dialog box, leave all defaults. Click **Finish**.

Step 4 Confirm that the newly created circuit appears on the Circuits tab list as a two-way circuit.



Note It is normal for the “[LPBKTERMINAL \(G1000\)](#)” condition on page 2-177 to appear during a loopback setup. The condition clears when you remove the loopback.

Step 5 Create the terminal loopback on the destination port being tested:

- a. Go to the node view of the destination node:
 - Choose **View > Go To Other Node** from the menu bar.
 - Choose the node from the drop-down list in the Select Node dialog box and click **OK**.
- b. In node view, double-click the card that requires the loopback.
- c. Click the **Maintenance > Loopback** tabs.
- d. Select **OOS,MT** from the Admin State column. If this is a multiport card, select the row appropriate for the desired port.
- e. Select **Terminal** from the Loopback Type column. If this is a multiport card, select the row appropriate for the desired port.
- f. Click **Apply**.

g. Click **Yes** in the confirmation dialog box.

Step 6 Complete the [“Test and Clear the Ethernet Terminal Loopback Circuit” procedure on page 1-89](#).

Test and Clear the Ethernet Terminal Loopback Circuit

- Step 1** If the test set is not already sending traffic, send test traffic on the loopback circuit.
- Step 2** Examine the test traffic being received by the test set. Look for errors or any other signal information that the test set is capable of indicating.
- Step 3** If the test set indicates a good circuit, no further testing is necessary on the loopback circuit. Clear the terminal loopback from the port:
- Double-click the intermediate-node card with the terminal loopback.
 - Click the **Maintenance > Loopback** tabs.
 - Select **None** from the Loopback Type column for the port being tested.
 - Select the appropriate state (IS; OOS,DSBLD; OOS,MT) in the Admin State column for the port being tested.
 - Click **Apply**.
 - Click **Yes** in the confirmation dialog box.
- Step 4** Clear the terminal loopback circuit:
- Click the **Circuits** tab.
 - Choose the loopback circuit being tested.
 - Click **Delete**.
 - Click **Yes** in the Delete Circuits dialog box. Do not check any check boxes.
- The entire circuit path has now passed its comprehensive series of loopback tests. This circuit qualifies to carry live traffic.
- Step 5** If the test set indicates a faulty circuit, the problem might be a faulty card.
- Step 6** Complete the [“Test the Ethernet Card” procedure on page 1-89](#).
-

Test the Ethernet Card

- Step 1** Complete the [“Physically Replace a Traffic Card” procedure on page 2-274](#) for the suspected bad card and replace it with a known-good card.
- Step 2** Resend test traffic on the loopback circuit with a known-good card.
- Step 3** If the test set indicates a good circuit, the problem was probably the defective card. Return the defective card to Cisco through the RMA process. Contact Cisco Technical Support at 1 800 553-2447.
- Step 4** Complete the [“Physically Replace a Traffic Card” procedure on page 2-274](#) for the defective card.
- Step 5** Clear the terminal loopback on the port:
- Double-click the source-node card with the terminal loopback.

1.5.8 Perform a Hairpin Test on a Destination-Node Ethernet Port

- b. Click the **Maintenance > Loopback** tabs.
 - c. Select **None** from the Loopback Type column for the port being tested.
 - d. Select the appropriate state (IS; OOS,DSBLD; OOS,MT) in the Admin State column for the port being tested.
 - e. Click **Apply**.
 - f. Click **Yes** in the confirmation dialog box.
- Step 6** Clear the terminal loopback circuit:
- a. Click the **Circuits** tab.
 - b. Choose the loopback circuit being tested.
 - c. Click **Delete**.
 - d. Click **Yes** in the Delete Circuits dialog box. Do not check any check boxes.
- Step 7** Complete the “1.5.8 Perform a Hairpin Test on a Destination-Node Ethernet Port” procedure on page 1-90.

1.5.8 Perform a Hairpin Test on a Destination-Node Ethernet Port

The hairpin test is performed on the cross-connect card in the network circuit. A hairpin circuit uses the same port as source as well as destination. Completing a successful hairpin through the card isolates the possibility that the cross-connect card is the cause of the faulty circuit. Figure 1-37 shows an example of a hairpin loopback on a destination-node port.

Figure 1-37 Hairpin on a Destination-Node Ethernet Port

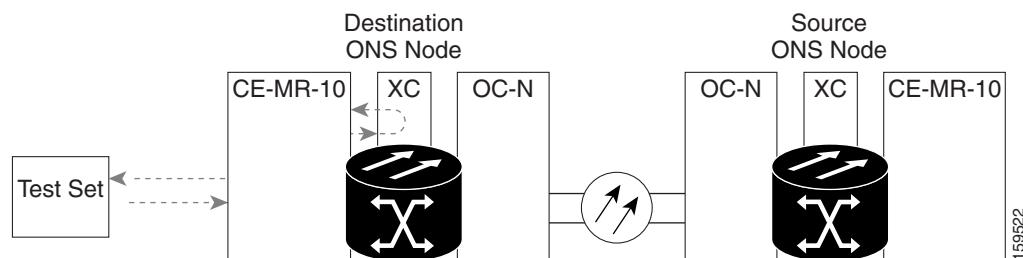

Note

The ONS 15454 does not support simplex operation on the cross-connect card. Two cross-connect cards of the same type must be installed for each node.



Note

Hairpin loopbacks require on-site personnel.

Complete the “[Create the Hairpin Circuit on the Destination-Node Port](#)” procedure on page 1-91.

Create the Hairpin Circuit on the Destination-Node Port

-
- Step 1** Connect an Ethernet test set to the port you are testing:
- If you just completed the [“1.5.7 Perform a Terminal Loopback on a Destination-Node Ethernet Port” procedure on page 1-87](#), leave the Ethernet test set hooked up to the Ethernet port in the destination node.
 - If you are starting the current procedure without the Ethernet test set hooked up to the Ethernet port, use appropriate cabling to connect the Ethernet test set to the port you are testing.
- Step 2** Adjust the test set accordingly. (Refer to manufacturer instructions for test-set use.)
- Step 3** Use CTC to set up the hairpin circuit on the test port:
- In node view, click the **Circuits** tab and click **Create**.
 - In the Circuit Creation dialog box, choose the type, such as STS, and number, such as 1.
 - Click **Next**.
 - In the next Circuit Creation dialog box, give the circuit an easily identifiable name such as Hairpin1.
 - Choose the Size, such as STS-1.
 - Uncheck the **Bidirectional** check box. Leave the default values for State, SD Threshold, and SF Threshold.
 - Click **Next**.
 - In the Circuit Creation source dialog box, select the same Node, card Slot, Port, and STS (or VT) where the test set is connected. Leave **Use Secondary Source** unchecked.
 - Click **Next**.
 - In the Circuit Creation destination dialog box, use the same Node, card Slot, Port, and STS (or VT) used for the source dialog box. Leave **Use Secondary Destination** unchecked.
 - Click **Next**.
 - In the Circuit Creation circuit routing preferences dialog box, leave all defaults. Click **Finish**.
- Step 4** Confirm that the newly created circuit appears on the Circuits tab and that the Dir column describes it as a one-way circuit.
- Step 5** Complete the [“Test and Delete the Ethernet Hairpin Circuit” procedure on page 1-91](#).
-

Test and Delete the Ethernet Hairpin Circuit

-
- Step 1** If the test set is not already sending traffic, send test traffic on the loopback circuit.
- Step 2** Examine the test traffic received by the test set. Look for errors or any other signal information that the test set is capable of indicating.
- Step 3** If the test set indicates a good circuit, no further testing is necessary with the hairpin circuit. Clear the hairpin circuit:
- Click the **Circuits** tab.
 - Choose the hairpin circuit being tested.
 - Click **Delete**.

- d. Click **Yes** in the Delete Circuits dialog box. Do not check any check boxes.
- e. Confirm that the hairpin circuit is deleted from the Circuits tab list.

Step 4 Complete the “[Test the Standby Cross-Connect Card](#)” procedure on page 1-92.

Test the Standby Cross-Connect Card



Note

Two cross-connect cards (active and standby) must be in use on a node to use this procedure.

Step 1 Perform a reset on the standby cross-connect card to make it the active card:

- a. Determine the standby cross-connect card. On both the physical node and the CTC node view window, the standby cross-connect ACT/SBY LED is amber and the active card ACT/SBY LED is green.
- b. Position the cursor over the standby cross-connect card.
- c. Right-click and choose **RESET CARD**.
- d. Click **Yes** in the confirmation dialog box.

Step 2 Initiate an external switching command (side switch) on the cross-connect cards before you retest the loopback circuit:



Caution

Cross-connect side switches, with the exception of side switches using XC-VXC-10G cards, are service-affecting. Any live traffic on any card in the node endures a hit of up to 50 ms. XC-VXC-10G side switches are errorless.

- a. Determine the standby cross-connect card. On both the physical node and the CTC node view window, the standby cross-connect ACT/SBY LED is amber and the active card ACT/SBY LED is green.
- b. In the node view, select the **Maintenance > Cross-Connect > Cards** tabs.
- c. In the Cross-Connect Cards area, click **Switch**.
- d. Click **Yes** in the Confirm Switch dialog box.



Note

After the active cross-connect goes into standby mode, the original standby card becomes active and its ACT/SBY LED turns green. The former active card becomes standby and its ACT/SBY LED turns amber.

Step 3 Resend test traffic on the loopback circuit.

The test traffic now travels through the alternate cross-connect card.

Step 4 If the test set indicates a faulty circuit, assume the cross-connect card is not causing the problem. Clear the hairpin circuit:

- a. Click the **Circuits** tab.
- b. Choose the hairpin circuit being tested.
- c. Click **Delete**.

- d. Click **Yes** in the Delete Circuits dialog box. Do not check any check boxes.
 - e. Confirm that the hairpin circuit is deleted from the Circuits tab list.
- Step 5** To confirm a defective original cross-connect card, complete the [“Retest the Original Cross-Connect Card” procedure on page 1-93](#).
-

Retest the Original Cross-Connect Card

- Step 1** Initiate an external switching command (side switch) on the cross-connect cards:
- a. Determine the standby cross-connect card. On both the physical node and the CTC node view window, the standby cross-connect ACT/SBY LED is amber and the active card ACT/SBY LED is green.
 - b. In node view, select the **Maintenance > Cross-Connect > Cards** tabs.
 - c. From the Cross-Connect Cards menu, choose **Switch**.
 - d. Click **Yes** in the Confirm Switch dialog box.



Note After the active cross-connect goes into standby mode, the original standby card becomes active and its ACT/SBY LED turns green. The former active card becomes standby and its ACT/SBY LED turns amber.

- Step 2** Resend test traffic on the loopback circuit.
- Step 3** If the test set indicates a faulty circuit, the problem is probably the defective card. Return the defective card to Cisco through the RMA process. Contact Cisco Technical Support at 1 800 553-2447 and proceed to Step 4. If the test does not indicate a faulty circuit, proceed to Step 5.
- Step 4** Complete the [“Physically Replace an In-Service Cross-Connect Card” procedure on page 2-274](#) for the defective cross-connect card.
- Step 5** If the test set indicates a good circuit, the cross-connect card might have had a temporary problem that was cleared by the side switch. Clear the hairpin circuit:
- a. Click the **Circuits** tab.
 - b. Choose the hairpin circuit being tested.
 - c. Click **Delete**.
 - d. Click **Yes** in the Delete Circuits dialog box. Do not check any check boxes.
 - e. Confirm that the hairpin circuit is deleted from the Circuits tab list.

The entire circuit path has now passed its comprehensive series of loopback tests. This circuit qualifies to carry live traffic.

1.6 Troubleshooting FC_MR Circuit Paths With Loopbacks

Facility loopbacks, terminal loopbacks, and cross-connect loopback circuits are often used together to test the circuit path through the network or to logically isolate a fault. Performing a loopback test at each point along the circuit path systematically isolates possible points of failure. FC_MR loopback tests differ from electrical, optical, and Ethernet testing because loopback testing does not require circuit creation. FC_MR client ports are statically mapped to the trunk ports so no signal needs to traverse the cross-connect card (in a circuit) to test the loopback.

You can use these procedures on fibre channel data storage (FC_MR) cards. The example in this section tests an FC_MR circuit on a three-node BLSR. Using a series of facility loopbacks and terminal loopbacks, the example scenario traces the circuit path, tests the possible failure points, and eliminates them. The logical progression contains seven network test procedures:

Note

FC_MR card client ports do not appear in the Maintenance > Loopback tabs unless they have been provisioned. Provision ports in the card view Provisioning > Pluggable Port Modules tab. For information about provisioning client ports, refer to the *Cisco ONS 15454 Procedure Guide*.

Note

The test sequence for your circuits will differ according to the type of circuit and network topology.

1. A facility loopback on the source-node FC_MR port
2. A terminal loopback on the source-node FC_MR port
3. A facility loopback on the destination-node FC_MR port
4. A terminal loopback on the destination-node FC_MR port

Note

Facility, hairpin, and terminal loopback tests require on-site personnel.

1.6.1 Perform a Facility Loopback on a Source-Node FC_MR Port

The facility loopback test is performed on the node source port in the network circuit. In the testing situation used in this example, the source muxponder or transponder port in the source node. Completing a successful facility loopback on this port isolates the FC_MR port as a possible failure point.

[Figure 1-38](#) shows an example of a facility loopback on a circuit source FC_MR port.

Figure 1-38 Facility Loopback on a Circuit Source FC_MR Port

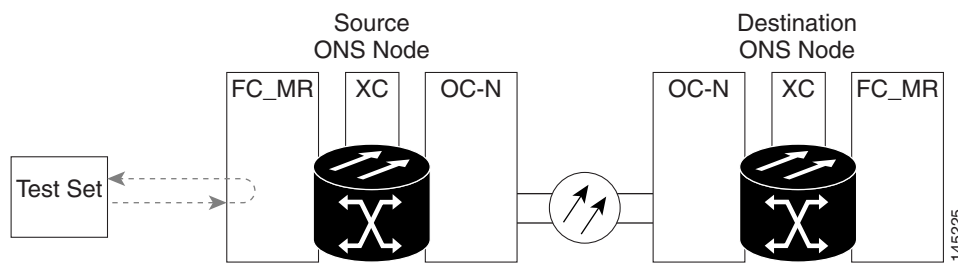

**Caution**

Performing a loopback on an in-service circuit is service-affecting.

**Note**

Facility loopbacks require on-site personnel.

Complete the [“Create the Facility Loopback on the Source-Node FC_MR Port”](#) procedure on page 1-95.

Create the Facility Loopback on the Source-Node FC_MR Port

Step 1 Connect an optical test set to the port you are testing.

**Note**

For specific procedures to connect, set up, and use the test set equipment, consult the manufacturer.

Use appropriate cabling to attach the Tx and Rx terminals of the optical test set to the port you are testing. The Tx and Rx terminals connect to the same port.

Step 2 Adjust the test set accordingly. (Refer to manufacturer instructions for test-set use.)

Step 3 In CTC node view, double-click the card to open the card view.

Step 4 Click the **Maintenance > Loopback** tabs.

Step 5 Choose **OOS,MT** from the Admin State column for the port being tested. If this is a multiport card, select the appropriate row for the desired port.

Step 6 Choose **Facility** from the Loopback Type column for the port being tested. If this is a multiport card, select the appropriate row for the desired port.

Step 7 Click **Apply**.

Step 8 Click **Yes** in the confirmation dialog box.

**Note**

It is normal for the [“CLPBKFACILITY \(OCN\)”](#) condition on page 2-173 or the [“LPBKFACILITY \(G1000\)”](#) condition on page 2-172 to appear during loopback setup. The condition clears when you remove the loopback.

Step 9 Complete the [“Test and Clear the FC_MR Facility Loopback Circuit”](#) procedure on page 1-95.

Test and Clear the FC_MR Facility Loopback Circuit

Step 1 If the test set is not already sending traffic, send test traffic on the loopback circuit.

Step 2 Examine the traffic received by the test set. Look for errors or any other signal information that the test set is capable of indicating.

Step 3 If the test set indicates a good circuit, no further testing is necessary with the facility loopback. Clear the facility loopback:

- a. Click the **Maintenance > Loopback** tabs.

- b. Choose **None** from the Loopback Type column for the port being tested.
 - c. Choose the appropriate state (**IS; OOS,DSBLD; OOS,MT; IS,AINS**) from the Admin State column for the port being tested.
 - d. Click **Apply**.
 - e. Click **Yes** in the confirmation dialog box.
- Step 4** Complete the [“Test the FC_MR Card” procedure on page 1-96](#).
-

Test the FC_MR Card

- Step 1** Complete the [“Physically Replace a Traffic Card” procedure on page 2-274](#) for the suspected bad card and replace it with a known-good one.
- Step 2** Resend test traffic on the loopback circuit with a known-good card installed.
- Step 3** If the test set indicates a good circuit, the problem was probably the defective card. Return the defective card to Cisco through the RMA process. Contact Cisco Technical Support at 1 800 553-2447.
- Step 4** Complete the [“Physically Replace a Traffic Card” procedure on page 2-274](#) for the faulty card.
- Step 5** Clear the facility loopback:
- a. Click the **Maintenance > Loopback** tabs.
 - b. Choose **None** from the Loopback Type column for the port being tested.
 - c. Choose the appropriate state (**IS; OOS,DSBLD; OOS,MT; IS,AINS**) from the Admin State column for the port being tested.
 - d. Click **Apply**.
 - e. Click **Yes** in the confirmation dialog box.
- Step 6** Complete the [“1.6.2 Perform a Terminal Loopback on a Source-Node FC_MR Port” procedure on page 1-96](#).
-

1.6.2 Perform a Terminal Loopback on a Source-Node FC_MR Port

The terminal loopback test is performed on the node source FC_MR muxponder or transponder port. For the circuit in this example, the test port is the source FC_MR port in the source node. Completing a successful terminal loopback to a node source port verifies that the circuit is good to the source port. [Figure 1-39](#) shows an example of a terminal loopback on a source FC_MR port.

Figure 1-39 Terminal Loopback on a Source-Node FC_MR Port

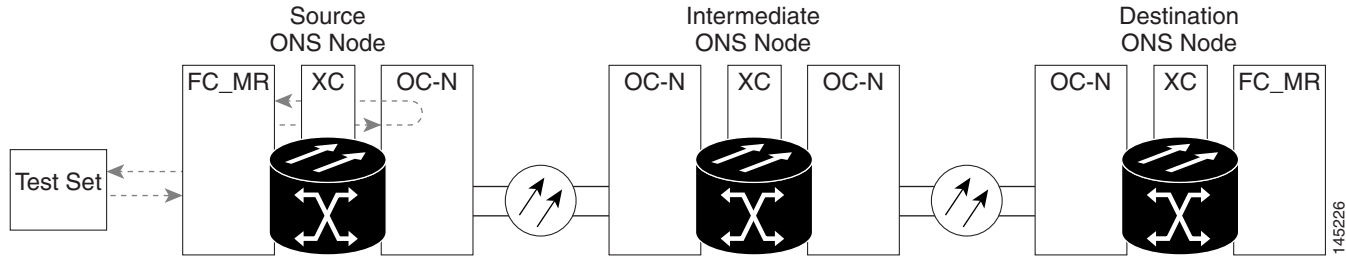

 **Caution**

Performing a loopback on an in-service circuit is service-affecting.

 **Note**

Terminal loopbacks require on-site personnel.

Complete the [“Create the Terminal Loopback on a Source-Node FC_MR Port”](#) procedure on page 1-97.

Create the Terminal Loopback on a Source-Node FC_MR Port

Step 1 Connect an optical test set to the port you are testing:



Note For specific procedures to connect, set up, and use the test set equipment, consult the manufacturer.

- a. If you just completed the [“1.6.1 Perform a Facility Loopback on a Source-Node FC_MR Port”](#) procedure on page 1-94, leave the optical test set hooked up to the FC_MR port in the source node.
- b. If you are starting the current procedure without the optical test set hooked up to the source port, use appropriate cabling to attach the Tx and Rx terminals of the optical test set to the port you are testing. Both Tx and Rx connect to the same port.

Step 2 Adjust the test set accordingly. (Refer to manufacturer instructions for test-set use.)

Step 3 In node view, double-click the card that requires the loopback, such as the destination OC-N card in the source node.

Step 4 Click the **Maintenance > Loopback** tabs.

Step 5 Select **OOS,MT** from the Admin State column. If this is a multiport card, select the row appropriate for the desired port.

Step 6 Select **Terminal** from the Loopback Type column. If this is a multiport card, select the row appropriate for the desired port.

Step 7 Click **Apply**.

Step 8 Click **Yes** in the confirmation dialog box.

Step 9 Complete the [“Test and Clear the FC_MR Port Terminal Loopback Circuit”](#) procedure on page 1-98.

Test and Clear the FC_MR Port Terminal Loopback Circuit

- Step 1** If the test set is not already sending traffic, send test traffic on the loopback circuit.
- Step 2** Examine the test traffic being received by the test set. Look for errors or any other signal information that the test set is capable of indicating.
- Step 3** If the test set indicates a good circuit, no further testing is necessary on the loopback circuit. Clear the terminal loopback state on the port:
- Double-click the card in the source node with the terminal loopback.
 - Click the **Maintenance > Loopback** tabs.
 - Select **None** from the Loopback Type column for the port being tested.
 - Select the appropriate state (**IS; OOS,DSBLD; OOS,MT; IS,AINS**) in the Admin State column for the port being tested.
 - Click **Apply**.
 - Click **Yes** in the confirmation dialog box.
- Step 4** Complete the [“Test the FC_MR Card” procedure on page 1-98](#).
-

Test the FC_MR Card

- Step 1** Complete the [“Physically Replace a Traffic Card” procedure on page 2-274](#) for the suspected bad card and replace it with a known-good one.
- Step 2** Resend test traffic on the loopback circuit with a known-good card.
- Step 3** If the test set indicates a good circuit, the problem was probably the defective card. Return the defective card to Cisco through the RMA process. Contact Cisco Technical Support at 1 800 553-2447.
- Step 4** Complete the [“Physically Replace a Traffic Card” procedure on page 2-274](#) for the defective card.
- Step 5** Clear the terminal loopback on the port before testing the next segment of the network circuit path:
- Double-click the card in the source node with the terminal loopback.
 - Click the **Maintenance > Loopback** tabs.
 - Select **None** from the Loopback Type column for the port being tested.
 - Select the appropriate state (**IS; OOS,DSBLD; OOS,MT; IS,AINS**) in the Admin State column for the port being tested.
 - Click **Apply**.
 - Click **Yes** in the confirmation dialog box.
- Step 6** Complete the [“1.6.3 Create a Facility Loopback on an Intermediate-Node FC_MR Port” procedure on page 1-99](#).
-

1.6.3 Create a Facility Loopback on an Intermediate-Node FC_MR Port

Performing the facility loopback test on an intermediate port determines whether this node is causing circuit failure. In the example shown in [Figure 1-40](#), the test is being performed on an intermediate FC_MR port.

Figure 1-40 Facility Loopback on an Intermediate-Node FC_MR Port

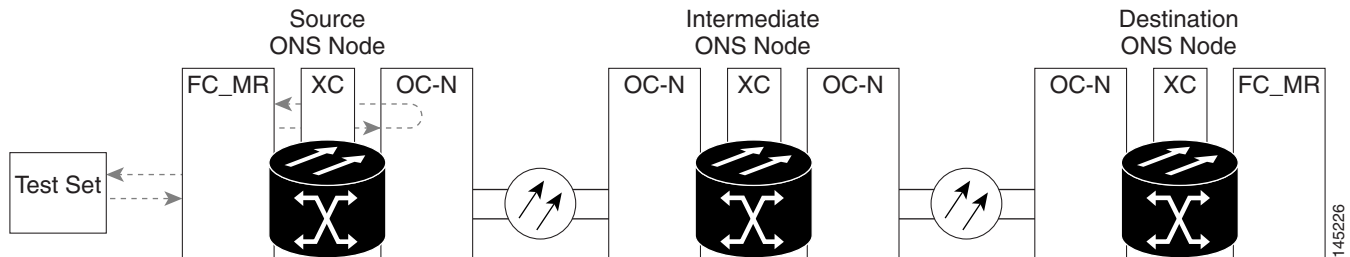

Caution

Performing a loopback on an in-service circuit is service-affecting.



Note

Facility loopbacks require on-site personnel.

Complete the [“Create a Facility Loopback on an Intermediate-Node FC_MR Port” procedure on page 1-99](#).

Create a Facility Loopback on an Intermediate-Node FC_MR Port

Step 1 Connect an optical test set to the port you are testing:



Note

For specific procedures to connect, set up, and use the test set equipment, consult the manufacturer.

- a. If you just completed the [“1.6.2 Perform a Terminal Loopback on a Source-Node FC_MR Port” procedure on page 1-96](#), leave the optical test set hooked up to the source-node port.
- b. If you are starting the current procedure without the optical test set hooked up to the source port, use appropriate cabling to attach the Tx and Rx terminals of the optical test set to the port you are testing. Both Tx and Rx connect to the same port.

Step 2 Adjust the test set accordingly. (Refer to manufacturer instructions for test-set use.)

Step 3 In node view, double-click the intermediate-node card that requires the loopback.

Step 4 Click the **Maintenance > Loopback** tabs.

Step 5 Select **OOS,MT** from the Admin State column. If this is a multiport card, select the row appropriate for the desired port.

Step 6 Select **Facility** from the Loopback Type column. If this is a multiport card, select the row appropriate for the desired port.

Step 7 Click **Apply**.

1.6.3 Create a Facility Loopback on an Intermediate-Node FC_MR Port

- Step 8** Click **Yes** in the confirmation dialog box.
- Step 9** Complete the [“Test and Clear the FC_MR Port Facility Loopback Circuit” procedure on page 1-100.](#)
-

Test and Clear the FC_MR Port Facility Loopback Circuit

- Step 1** If the test set is not already sending traffic, send test traffic on the loopback circuit.
- Step 2** Examine the traffic received by the test set. Look for errors or any other signal information that the test set is capable of indicating.
- Step 3** If the test set indicates a good circuit, no further testing is necessary with the facility loopback. Clear the facility loopback from the port:
- Click the **Maintenance > Loopback** tabs.
 - Choose **None** from the Loopback Type column for the port being tested.
 - Choose the appropriate state (**IS; OOS,DSBLD; OOS,MT; IS,AINS**) from the Admin State column for the port being tested.
 - Click **Apply**.
 - Click **Yes** in the confirmation dialog box.
- Step 4** Complete the [“Test the FC_MR Card” procedure on page 1-100.](#)
-

Test the FC_MR Card

- Step 1** Complete the [“Physically Replace a Traffic Card” procedure on page 2-274](#) for the suspected bad card and replace it with a known-good one.
- Step 2** Resend test traffic on the loopback circuit with a known-good card installed.
- Step 3** If the test set indicates a good circuit, the problem was probably the defective card. Return the defective card to Cisco through the RMA process. Contact Cisco Technical Support at 1 800 553-2447.
- Step 4** Complete the [“Physically Replace a Traffic Card” procedure on page 2-274](#) for the faulty card.
- Step 5** Clear the facility loopback from the port:
- Click the **Maintenance > Loopback** tabs.
 - Choose **None** from the Loopback Type column for the port being tested.
 - Choose the appropriate state (**IS; OOS,DSBLD; OOS,MT; IS,AINS**) from the Admin State column for the port being tested.
 - Click **Apply**.
 - Click **Yes** in the confirmation dialog box.
- Step 6** Complete the [“1.6.4 Create a Terminal Loopback on Intermediate-Node FC_MR Ports” procedure on page 1-101.](#)
-

1.6.4 Create a Terminal Loopback on Intermediate-Node FC_MR Ports

In the next troubleshooting test, you perform a terminal loopback on the intermediate-node port to isolate whether the destination port is causing circuit trouble. In the example situation in [Figure 1-41](#), the terminal loopback is performed on an intermediate FC_MR port in the circuit. If you successfully complete a terminal loopback on the node, this node is excluded from possible sources of circuit trouble.

Figure 1-41 Terminal Loopback on an Intermediate-Node FC_MR Port

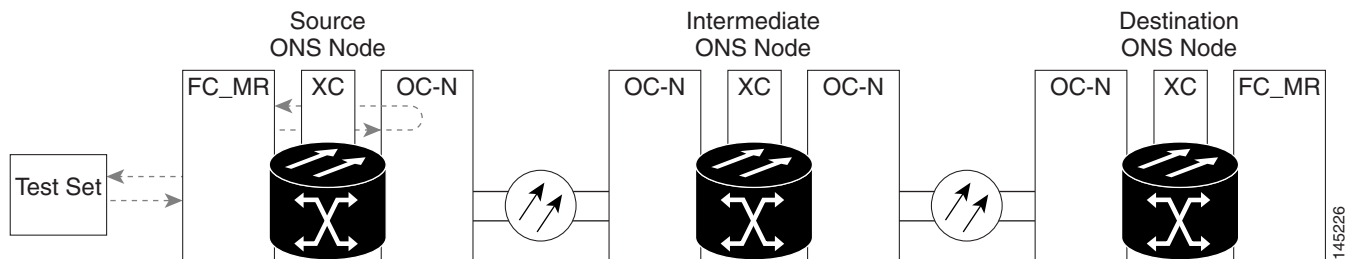

Caution

Performing a loopback on an in-service circuit is service-affecting.



Note

Terminal loopbacks require on-site personnel.

Complete the [“Create a Terminal Loopback on Intermediate-Node FC_MR Ports” procedure on page 1-101](#).

Create a Terminal Loopback on Intermediate-Node FC_MR Ports

Step 1 Connect an optical test set to the port you are testing:



Note

For specific procedures to connect, set up, and use the test set equipment, consult the manufacturer.

- a. If you just completed the [“1.6.3 Create a Facility Loopback on an Intermediate-Node FC_MR Port” section on page 1-99](#), leave the optical test set hooked up to the source-node port.
- b. If you are starting the current procedure without the optical test set hooked up to the source port, use appropriate cabling to attach the Tx and Rx terminals of the optical test set to the port you are testing. Both Tx and Rx connect to the same port.

Step 2 Adjust the test set accordingly. (Refer to manufacturer instructions for test-set use.)

Step 3 Create the terminal loopback on the destination port being tested:

- a. Go to the node view of the intermediate node:
 - Choose **View > Go To Other Node** from the menu bar.
 - Choose the node from the drop-down list in the Select Node dialog box and click **OK**.
- b. In node view, double-click the card that requires the loopback.

- c. Click the **Maintenance > Loopback** tabs.
 - d. Select **OOS,MT** from the Admin State column. If this is a multiport card, select the row appropriate for the desired port.
 - e. Select **Terminal** from the Loopback Type column. If this is a multiport card, select the row appropriate for the desired port.
 - f. Click **Apply**.
 - g. Click **Yes** in the confirmation dialog box.
- Step 4** Complete the [“Test and Clear the FC_MR Terminal Loopback Circuit” procedure on page 1-102](#).
-

Test and Clear the FC_MR Terminal Loopback Circuit

- Step 1** If the test set is not already sending traffic, send test traffic on the loopback circuit.
- Step 2** Examine the test traffic being received by the test set. Look for errors or any other signal information that the test set is capable of indicating.
- Step 3** If the test set indicates a good circuit, no further testing is necessary on the loopback circuit. Clear the terminal loopback from the port:
- a. Double-click the intermediate-node card with the terminal loopback to open the card view.
 - b. Click the **Maintenance > Loopback** tabs.
 - c. Select **None** from the Loopback Type column for the port being tested.
 - d. Select the appropriate state (**IS; OOS,DSBLD; OOS,MT; IS,AINS**) in the Admin State column for the port being tested.
 - e. Click **Apply**.
 - f. Click **Yes** in the confirmation dialog box.
- Step 4** Complete the [“Test the FC_MR Card” procedure on page 1-102](#).
-

Test the FC_MR Card

- Step 1** Complete the [“Physically Replace a Traffic Card” procedure on page 2-274](#) for the suspected bad card and replace it with a known-good one.
- Step 2** Resend test traffic on the loopback circuit with a known-good card.
- Step 3** If the test set indicates a good circuit, the problem was probably the defective card. Return the defective card to Cisco through the RMA process. Contact Cisco Technical Support at 1 800 553-2447.
- Step 4** Complete the [“Physically Replace a Traffic Card” procedure on page 2-274](#) for the defective card.
- Step 5** Clear the terminal loopback on the port:
- a. Double-click the source-node card with the terminal loopback.
 - b. Click the **Maintenance > Loopback** tabs.
 - c. Select **None** from the Loopback Type column for the port being tested.

- d. Select the appropriate state (**IS**; **OOS,DSBLD**; **OOS,MT**; **IS,AINS**) in the Admin State column for the port being tested.
- e. Click **Apply**.
- f. Click **Yes** in the confirmation dialog box.

Step 6 Complete the “[1.6.5 Perform a Facility Loopback on a Destination-Node FC_MR Port](#)” procedure on page 1-103.

1.6.5 Perform a Facility Loopback on a Destination-Node FC_MR Port

You perform a facility loopback test at the destination port to determine whether this local port is the source of circuit trouble. The example in [Figure 1-42](#) shows a facility loopback being performed on an FC_MR port.

Figure 1-42 Facility Loopback on a Destination-Node FC_MR Port

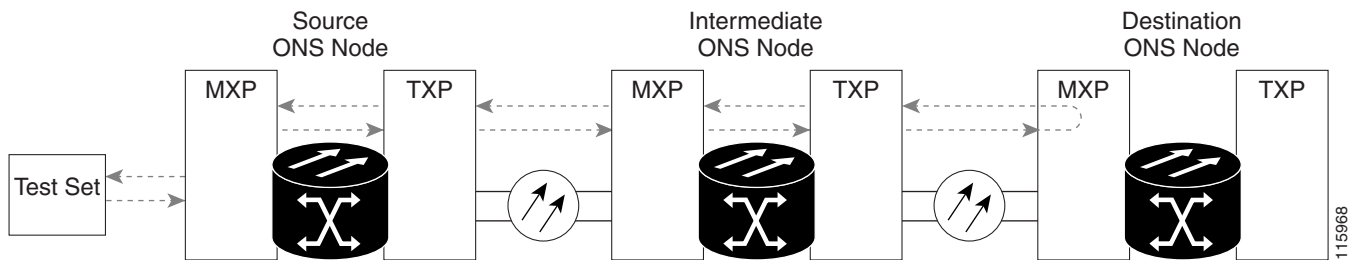

Caution

Performing a loopback on an in-service circuit is service-affecting.



Note

Facility loopbacks require on-site personnel.

Complete the “[Create the Facility Loopback on a Destination-Node FC_MR Port](#)” procedure on page 1-103.

Create the Facility Loopback on a Destination-Node FC_MR Port

Step 1 Connect an optical test set to the port you are testing:



Note

For specific procedures to connect, set up, and use the test set equipment, consult the manufacturer.

- a. If you just completed the “[1.6.4 Create a Terminal Loopback on Intermediate-Node FC_MR Ports](#)” procedure on page 1-101, leave the optical test set hooked up to the source-node port.

1.6.5 Perform a Facility Loopback on a Destination-Node FC_MR Port

- b. If you are starting the current procedure without the optical test set hooked up to the source port, use appropriate cabling to attach the Tx and Rx terminals of the optical test set to the port you are testing. Both Tx and Rx connect to the same port.
- Step 2** Adjust the test set accordingly. (Refer to manufacturer instructions for test-set use.)
- Step 3** Create the facility loopback on the destination port being tested:
- a. Go to the node view of the destination node:
 - Choose **View > Go To Other Node** from the menu bar.
 - Choose the node from the drop-down list in the Select Node dialog box and click **OK**.
 - b. In node view, double-click the card that requires the loopback.
 - c. Click the **Maintenance > Loopback** tabs.
 - d. Select **OOS,MT** from the Admin State column. If this is a multiport card, select the row appropriate for the desired port.
 - e. Select **Facility** from the Loopback Type column. If this is a multiport card, select the row appropriate for the desired port.
 - f. Click **Apply**.
 - g. Click **Yes** in the confirmation dialog box.
- Step 4** Complete the [“Test and Clear the FC_MR Facility Loopback Circuit” procedure on page 1-104](#).
-

Test and Clear the FC_MR Facility Loopback Circuit

- Step 1** If the test set is not already sending traffic, send test traffic on the loopback circuit.
- Step 2** Examine the traffic received by the test set. Look for errors or any other signal information that the test set is capable of indicating.
- Step 3** If the test set indicates a good circuit, no further testing is necessary with the facility loopback. Clear the facility loopback from the port:
- a. Click the **Maintenance > Loopback** tabs.
 - b. Choose **None** from the Loopback Type column for the port being tested.
 - c. Choose the appropriate state (**IS; OOS,DSBLD; OOS,MT; IS,AINS**) from the Admin State column for the port being tested.
 - d. Click **Apply**.
 - e. Click **Yes** in the confirmation dialog box.
- Step 4** Complete the [“Test the FC_MR Card” procedure on page 1-104](#).
-

Test the FC_MR Card

- Step 1** Complete the [“Physically Replace a Traffic Card” procedure on page 2-274](#) for the suspected bad card and replace it with a known-good one.
- Step 2** Resend test traffic on the loopback circuit with a known-good card installed.

- Step 3** If the test set indicates a good circuit, the problem was probably the defective card. Return the defective card to Cisco through the RMA process. Contact Cisco Technical Support at 1 800 553-2447.
- Step 4** Complete the [“Physically Replace a Traffic Card” procedure on page 2-274](#) for the faulty card.
- Step 5** Clear the facility loopback on the port:
- Click the **Maintenance > Loopback** tabs.
 - Choose **None** from the Loopback Type column for the port being tested.
 - Choose the appropriate state (**IS; OOS,DSBLD; OOS,MT; IS,AINS**) from the Admin State column for the port being tested.
 - Click **Apply**.
 - Click **Yes** in the confirmation dialog box.
- Step 6** Complete the [“1.6.6 Perform a Terminal Loopback on a Destination-Node FC_MR Port” procedure on page 1-105](#).

1.6.6 Perform a Terminal Loopback on a Destination-Node FC_MR Port

The terminal loopback at the destination-node port is the final local hardware error elimination in the circuit troubleshooting process. If this test is completed successfully, you have verified that the circuit is good up to the destination port. The example in [Figure 1-43](#) shows a terminal loopback on an intermediate-node destination FC_MR port.

Figure 1-43 Terminal Loopback on a Destination-Node FC_MR Port

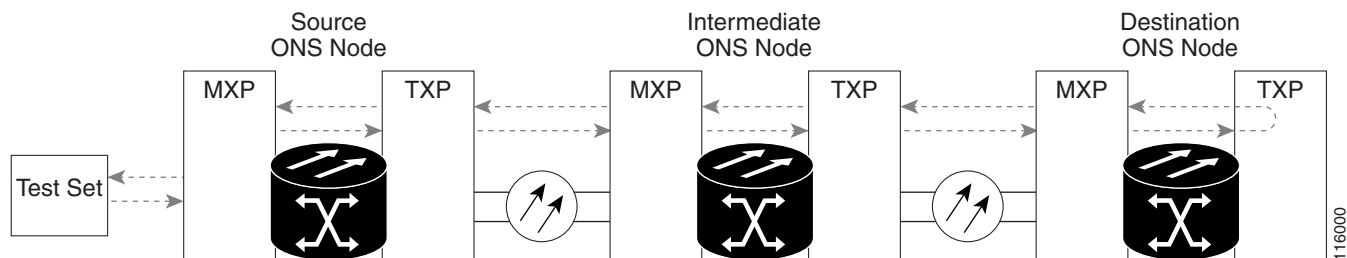

Caution

Performing a loopback on an in-service circuit is service-affecting.



Note

Terminal loopbacks require on-site personnel.

Complete the [“Create the Terminal Loopback on a Destination-Node FC_MR Port” procedure on page 1-105](#).

Create the Terminal Loopback on a Destination-Node FC_MR Port

- Step 1** Connect an optical test set to the port you are testing:



Note For specific procedures to connect, set up, and use the test set equipment, consult the manufacturer.

- a. If you just completed the [“1.6.5 Perform a Facility Loopback on a Destination-Node FC_MR Port” procedure on page 1-103](#), leave the optical test set hooked up to the source port.
- b. If you are starting the current procedure without the optical test set hooked up to the source port, use appropriate cabling to attach the Tx and Rx terminals of the optical test set to the port you are testing. Both Tx and Rx connect to the same port.

Step 2 Adjust the test set accordingly. (Refer to manufacturer instructions for test-set use.)

Step 3 Confirm that the newly created circuit appears on the Circuits tab list as a two-way circuit.



Note It is normal for the [“LPBKTERMINAL \(OCN\)” condition on page 2-177](#) to appear during a loopback setup. The condition clears when you remove the loopback.

Step 4 Create the terminal loopback on the destination port being tested:

- a. Go to the node view of the destination node:
 - Choose **View > Go To Other Node** from the menu bar.
 - Choose the node from the drop-down list in the Select Node dialog box and click **OK**.
- b. In node view, double-click the card that requires the loopback.
- c. Click the **Maintenance > Loopback** tabs.
- d. Select **OOS,MT** from the Admin State column. If this is a multiport card, select the row appropriate for the desired port.
- e. Select **Terminal** from the Loopback Type column. If this is a multiport card, select the row appropriate for the desired port.
- f. Click **Apply**.
- g. Click **Yes** in the confirmation dialog box.

Step 5 Complete the [“Test and Clear the FC_MR Terminal Loopback Circuit” procedure on page 1-106](#).

Test and Clear the FC_MR Terminal Loopback Circuit

Step 1 If the test set is not already sending traffic, send test traffic on the loopback circuit.

Step 2 Examine the test traffic being received by the test set. Look for errors or any other signal information that the test set is capable of indicating.

Step 3 If the test set indicates a good circuit, no further testing is necessary on the loopback circuit. Clear the terminal loopback from the port:

- a. Double-click the intermediate-node card with the terminal loopback.
- b. Click the **Maintenance > Loopback** tabs.
- c. Select **None** from the Loopback Type column for the port being tested.

- d. Select the appropriate state (**IS; OOS,DSBLD; OOS,MT; IS,AINS**) in the Admin State column for the port being tested.
 - e. Click **Apply**.
 - f. Click **Yes** in the confirmation dialog box.
- Step 4** If the test set indicates a faulty circuit, the problem might be a faulty card.
- Step 5** Complete the [“Test the FC_MR Card” procedure on page 1-107](#).
-

Test the FC_MR Card

-
- Step 1** Complete the [“Physically Replace a Traffic Card” procedure on page 2-274](#) for the suspected bad card and replace it with a known-good card.
- Step 2** Resend test traffic on the loopback circuit with a known-good card.
- Step 3** If the test set indicates a good circuit, the problem was probably the defective card. Return the defective card to Cisco through the RMA process. Contact Cisco Technical Support at 1 800 553-2447.
- Step 4** Complete the [“Physically Replace a Traffic Card” procedure on page 2-274](#) for the defective card.
- Step 5** Clear the terminal loopback on the port:
- a. Double-click the source-node card with the terminal loopback.
 - b. Click the **Maintenance > Loopback** tabs.
 - c. Select **None** from the Loopback Type column for the port being tested.
 - d. Select the appropriate state (**IS; OOS,DSBLD; OOS,MT; IS,AINS**) in the Admin State column for the port being tested.
 - e. Click **Apply**.
 - f. Click **Yes** in the confirmation dialog box.

The entire circuit path has now passed its comprehensive series of loopback tests. This circuit qualifies to carry live traffic.

1.7 Using CTC Diagnostics

CTC provides diagnostics for the following functions:

- Verifying proper card ASICS function
- Verifying standby card operation
- Verifying proper card LED operation
- Diagnostic circuit creation
- Customer problem notifications detected via alarms
- Provision of a downloadable, machine-readable diagnostic information file to be used by Cisco Technical Support.

Some of these functions, such as ASIC verification and standby card operation, are invisibly monitored in background functions. Change or problem notifications are provided in the Alarms and Conditions window. Other diagnostic functions—verifying card LED function, creating bidirectional diagnostic circuits, and also downloading diagnostic files for technical support—are available to the user in the node view Maintenance > Diagnostic tabs. The user-operated diagnostic features are described in the following paragraphs.

1.7.1 Card LED Lamp Tests

A card LED lamp test determines whether card-level indication LEDs are operational. This diagnostic test is run as part of the initial ONS 15454 turn-up, during maintenance routines, or any time you question whether an LED is in working order. Maintenance or higher-level users can complete the following tasks to verify LED operation.

Verify General Card LED Operation

Step 1 In node view, click the **Maintenance > Diagnostic** tabs (Figure 1-44).

Figure 1-44 CTC Node View Diagnostic Window

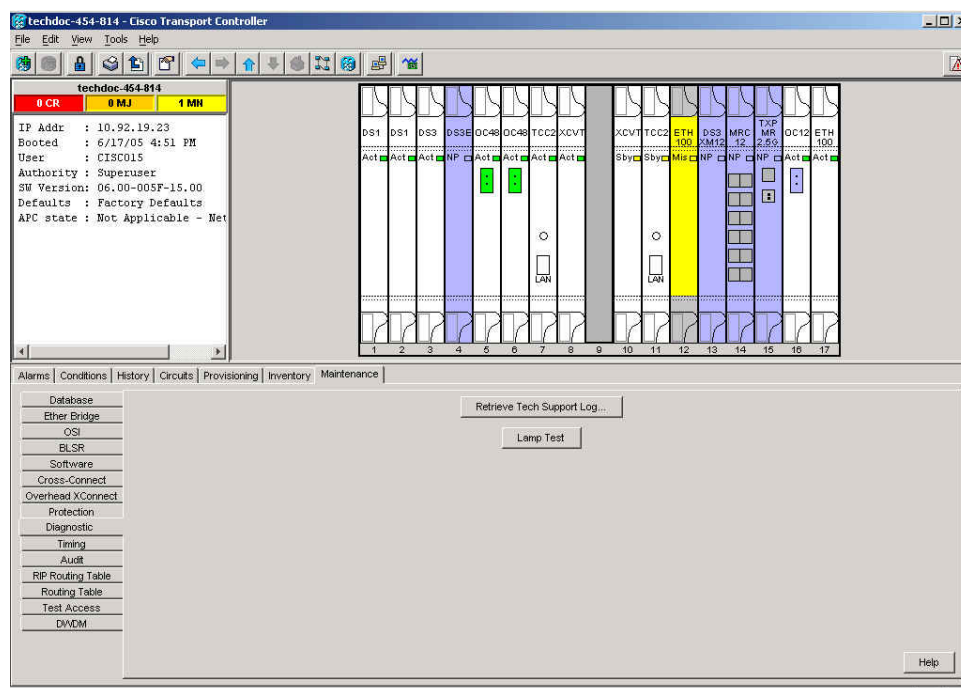

Step 2 Click **Lamp Test**.

Step 3 Watch to make sure all the port LEDs illuminate simultaneously for several seconds, with the following durations:

- For tri-color LEDs: three 5-second cycles
- For dual-color LEDs: one 5-second cycle and one 10-second cycle
- For the AIC or AIC-I: one 15-second cycle

Step 4 Click **OK** in the Lamp Test Run dialog box.

With the exceptions previously described, if an OC-N or DS-N LED does not light up, the LED is faulty. Return the defective card to Cisco through the RMA process. Contact the Cisco Technical Assistance Center (TAC) at 1 800 553-2447.

Verify G-Series Ethernet or FC_MR Card Port-Level LED Operation



Note G-Series and FC_MR card-level LEDs illuminate during a lamp test, but the port-level LEDs do not.

Step 1 Complete the “[Verify General Card LED Operation](#)” procedure on page 1-108 to verify that card-level LEDs are operational.

Step 2 Use the following list of guidelines to physically test whether the G-Series Ethernet port LEDs are operating correctly. If the LED appears as described when the listed state is occurring for the port, the LED is considered to be functioning correctly.

- Clear port LED: Should only occur if there is a loss of receive link (such as a disconnected link or unplugged Gigabit Interface Converter, [GBIC]). An LOS alarm could be present on the port.
- Amber port LED: Should only occur if a port is disabled but the link is connected, or if the port is enabled and the link is connected but a transport failure is present. A TPTFAIL alarm can be present on the port.
- Green port LED: Should occur if the port is enabled and has no errors against it or traffic in it. Can also occur if the port is enabled, has no errors, and is running traffic proportionate to the blink rate. No traffic-affecting port alarms should be present.

Step 3 If you are unable to determine the port state, contact Cisco Technical Support at 1 800 553-2447.

Verify E-Series and ML-Series Ethernet Card Port-Level LED Operation



Note E-Series and ML-Series card-level LEDs illuminate during a lamp test, but the port-level LEDs do not.



Note For information about the ML-Series card, refer to the *Cisco ONS 15454 and Cisco ONS 15454 SDH Ethernet Card Software Feature and Configuration Guide*.

Step 1 Complete the “[Verify General Card LED Operation](#)” procedure on page 1-108 to verify that card-level LEDs are operational.

Step 2 Use the following list of guidelines to physically test whether the single E-Series or ML-Series Ethernet port LED is operating correctly. If the LED appears as described when the listed state is occurring for the port, the LED is considered to be functioning correctly.

- Clear port LED: Should only occur if there is a loss of receive link (such as a disconnected link or unplugged GBIC), or if traffic is flowing in one direction (either transmit or receive). A CARLOSS alarm could be present on the port.

- Amber port LED: Should only occur if the link is connected and the physical port is transmitting and receiving traffic.
- Green port LED: Should occur if the link is up and no traffic is flowing on the port.

Step 3 If you are unable to determine the port state, contact Cisco Technical Support at 1 800 553-2447.

1.7.2 Retrieve Diagnostics File Button

When you click the Retrieve Diagnostics File button in the Maintenance window, CTC retrieves system data that can be off-loaded by a Maintenance or higher-level user to a local directory and sent to Technical Support for troubleshooting purposes. The diagnostics file is in machine language and is not human-readable, but can be used by Cisco Technical Support for problem analysis. Complete the following task to off-load the diagnostics file.



Note

In addition to the machine-readable diagnostics file, the ONS 15454 also stores an audit trail of all system events such as user logins, remote logins, configuration, and changes. This audit trail is considered a record-keeping feature rather than a troubleshooting feature. Information about the feature is located in the “Maintain the Node” chapter of the *Cisco ONS 15454 Procedure Guide*.

Off-Load the Diagnostics File

- Step 1** In the node view, click the **Maintenance > Diagnostic** tabs (Figure 1-44).
- Step 2** Click **Retrieve Tech Support Log**.
- Step 3** In the Saving Diagnostic File dialog box, navigate to the directory (local or network) where you want to save the file.
- Step 4** Enter a name in the File Name field.
- You do not have to give the archive file a particular extension. It is a compressed file (gzip) that can be unzipped and read by Cisco Technical Support.
- Step 5** Click **Save**.
- The Get Diagnostics status window shows a progress bar indicating the percentage of the file being saved, then shows “Get Diagnostics Complete.”
- Step 6** Click **OK**.
-

1.7.3 Bidirectional Diagnostic Circuit

CTC provides a diagnostic bidirectional loopback circuit feature that uses pseudo-random bit sequence (PRBS) error detection to monitor standby path protection, BLSR, 1+1, or unprotected circuit path readiness.

The diagnostic circuit is bidirectional and uses a single VT 1.5 in an STS. The circuit can traverse multiple nodes, but it must be carried by the same STS for the entire path. The circuit originates and ultimately destinations on the same node, but can be looped (by a hairpin circuit) through other nodes. After the circuit returns to the originating node, the signal result is detected and analyzed for errors by PRBS.

This type of circuit is created much the same way as a normal standby protection channel access (PCA) circuit, but is designated by checking the Diagnostic check box during circuit creation. A normal circuit uses line cards as the endpoints, but if a circuit is configured as a diagnostic, the endpoints are cross-connect cards.

Each card type utilizes the diagnostic feature differently. Standby electrical cards run PRBS tests to ensure signal path integrity. Optical cards do not run PRBS tests, but instead run ASIC tests to test card operability. Cross-connect cards verify the standby paths.

The diagnostic circuit can be configured for an end-to-end or multiple-node path layout, traversing the transmit and receive standby paths as shown in Figure 1-45.

Figure 1-45 CTC Node View Diagnostic Window

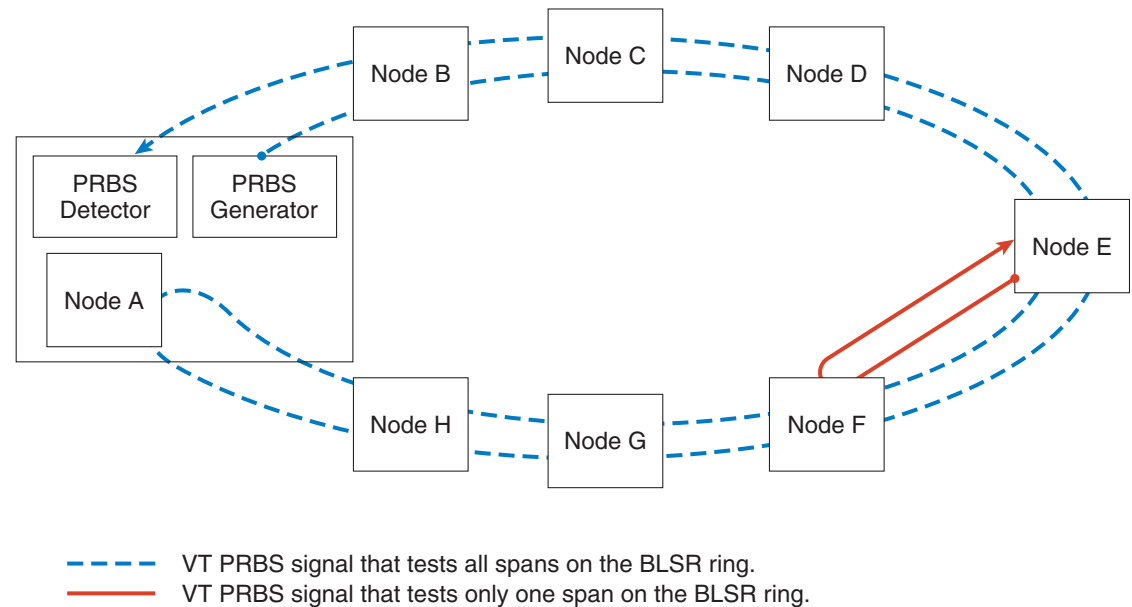

NOTE: The end without the arrow is where the PRBS pattern is generated. The end with the arrow is the end where the PRBS pattern is detected.

115747

The maximum diagnostic circuit size is VT1.5, and the maximum quantity of available diagnostic circuits is one per node. (In other words, if you create a diagnostic VT within an STS, the remaining 27 VTs can still be provisioned, and they may also contain diagnostic circuits originating on other nodes.)

As with all bidirectional circuits, a diagnostic circuit can only be created if the same STS is available on each span the circuit traverses. When you use a bidirectional diagnostic that traverses one or more intermediate nodes, create or utilize an existing bidirectional circuit on each intermediate node. At the terminating node, you will need to create a hairpin loopback at the end of the PRBS source span to return the signal.

**Note**

The diagnostic VT circuit does not raise a failure alarm if AIS-P or UNEQ-P is returned to the PRBS detector. In order to see an alarm indicating a failed diagnostic circuit, the circuit must be returned to the PRBS detector with a different payload than the generator sources and without the AIS-P or UNEQ-P conditions.

Create a Bidirectional Diagnostic Circuit

- Step 1** Log into the node where you will create the diagnostic circuit. (For login instructions, refer to the “Connect the PC and Log into the GUI” chapter in the *Cisco ONS 15454 Procedure Guide*.)
- Step 2** If you want to assign a name to the circuit source and destination ports before you create the circuit, refer to the task for assigning a name to a port in the “Create Circuits and VT Tunnels” chapter of the *Cisco ONS 15454 Procedure Guide*. If not, continue with [Step 3](#).
- Step 3** From the View menu, choose **Go to Network View**.
- Step 4** Click the **Circuits** tab, then click **Create**.
- Step 5** In the Circuit Creation dialog box, complete the following fields:
- Circuit Type—Choose **VT**.
 - Number of Circuits—Enter 1 (the maximum diagnostic circuit quantity available per STS).
 - Auto-ranged—Uncheck the box. (This option is not applicable to diagnostic circuits.)
- Step 6** Click **Next**.
- Step 7** Define the circuit attributes in the Circuit Creation Dialog Box ([Figure 1-46](#)) using the following parameters:

Figure 1-46 Network View Circuit Creation Dialog Box

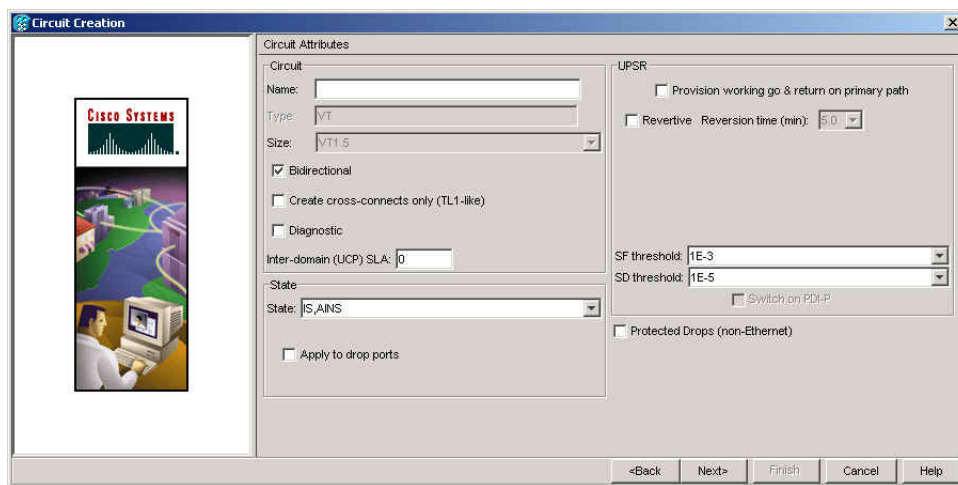

- Name—Assign a name to the circuit. The name can be alphanumeric and up to 48 characters, (including spaces). Circuit names should be 44 characters or less if you want the ability to create monitor circuits. If you leave the field blank, CTC assigns a default name to the circuit.
- Size—VT1.5 is the default. You cannot change it.

- Bidirectional—This is the default value. Leave it checked for this circuit.
- State—This option is not available when you check the Diagnostic option.
- Diagnostic—Check this box to create a diagnostic circuit.
- Apply to drop ports—Leave this box unchecked.
- Create cross-connects only (TL1-like)—Not applicable to diagnostic circuits.
- Inter-domain (UCP) SLA—Not applicable to diagnostic circuits.
- Protected Drops—Not applicable to diagnostic circuits.

Step 8 Click **Next**.

Step 9 In the Source area of the Circuit Creation pane, complete the following:

- a. From the Node drop-down list, choose the node.
- b. From the Slot drop-down list, choose **PRBS Generator**.
- c. Click **Next**.

Step 10 In the Destination area of the Circuit Creation pane, complete the following:

- a. From the Node drop-down list, choose the node. The only selectable item in the list is the node chosen as the source node.
- b. From the Slot drop-down list, choose the slot where the span originates.
- c. From the STS drop-down list, choose the STS.
- d. From the VT drop-down list, choose the VT.
- e. Click **Next**.

Step 11 Click **Finish**.

Step 12 In the Circuits window, verify that the new circuit(s) appear in the circuits list.

1.7.4 Data Communications Network Tool

CTC contains a data communications network (DCN) tool that assists with network troubleshooting for Open Shortest Path First (OSPF) networks. This tool, located in network view, is shown in [Figure 1-47](#). It executes an internal dump command to retrieve information about all nodes accessible from the entry point.

Figure 1-47 DCN Tools OSPF Dump

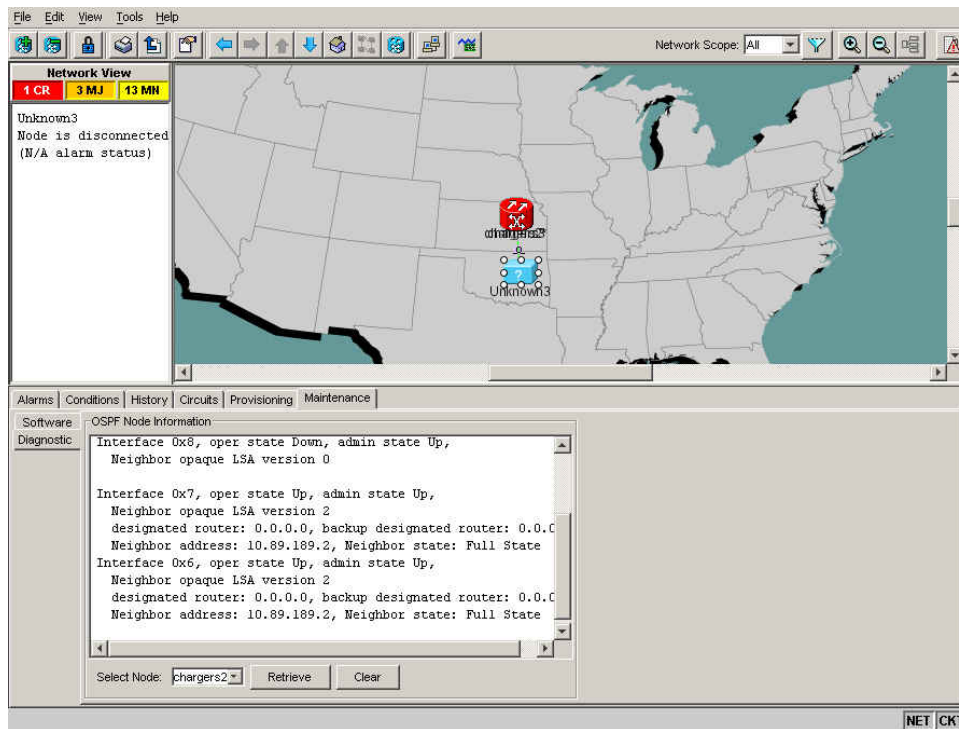

The dump, which provides the same information as a dump executed by special networking commands, is available at the network view in the Maintenance > Diagnostic tabs. You can select the access point node in the Select Node drop-down list. To create the dump, click Retrieve. (To clear the dump, click Clear.)

The contents of the dump file can be saved or printed and furnished to Cisco Technical Support for use in OSPF network support.

1.8 Restoring the Database and Default Settings

This section contains troubleshooting for node operation errors that require restoring software data or the default node setup.

1.8.1 Restore the Node Database

Symptom One or more nodes does not function properly or has incorrect data.

Possible Cause Incorrect or corrupted node database.

Recommended Action Complete the procedures in the “Maintain the Node” chapter of the *Cisco ONS 15454 Procedure Guide*.

1.9 PC Connectivity Troubleshooting

This section contains information about system minimum requirements, supported platforms, browsers, and JREs. It also contains troubleshooting procedures for PC and network connectivity to the ONS 15454.

1.9.1 PC System Minimum Requirements

Workstations running CTC Software Release 8.0 for the ONS products on Windows platforms must have the following minimum requirements:

- Pentium III or higher processor
- Processor speed of at least 700 MHz
- 256 MB or more of RAM
- 50 MB or more of available hard disk space
- 20 GB or larger hard drive

1.9.2 Sun System Minimum Requirements

Workstations running Software R8.0 for the ONS products on Sun workstations need to have the following minimum requirements:

- UltraSPARC or faster processor
- 256 MB or more of RAM
- 50 MB or more of available hard disk space

1.9.3 Supported Platforms, Browsers, and JREs

Software R8.0 supports the following platforms:

- Windows NT
- Windows 98
- Windows XP
- Windows 2000
- Solaris 9
- Solaris 10

Software R8.0 supports the following browsers and JREs:

- Netscape 7 browser (PC or Solaris 9 or 10 with JRE 5.0)
- PC platforms with JRE 5.0
- Internet Explorer 6.0 browser (on PC platforms with JRE 5.0)
- Mozilla 1.7 (Solaris 9 or 10 only with JRE 5.0)

**Note**

You can obtain browsers at the following URLs:
 Internet Explorer: <http://www.microsoft.com>
 Mozilla: <http://www.mozilla.org/>

**Note**

JRE 5.0 is required to run Software R8.0. JRE 5.0 is provided on the software CD.

1.9.4 Unsupported Platforms and Browsers

Software R8.0 does not support the following platforms:

- Windows 95
- Solaris 2.5
- Solaris 2.6

Software R8.0 does not support the following browsers and JREs:

- Netscape 4.73 for Windows.
- Netscape 4.76 on Solaris is not supported.
- Netscape 7 on Solaris 9 or 10 is only supported with JRE 5.0.

1.9.5 Unable to Verify the IP Configuration of Your PC

Symptom When connecting your PC to the ONS 15454, you are unable to successfully ping the IP address of your PC to verify the IP configuration.

Possible Cause The IP address and/or subnet mask was entered incorrectly.

Recommended Action Verify that the IP address used to ping the PC matches the IP address displayed when in the Windows IP Configuration information retrieved from the system. See the “[Verify the IP Configuration of Your PC](#)” procedure on page 1-116.

Possible Cause The IP configuration of your PC is not properly set.

Recommended Action Verify the IP configuration of your PC. Complete the “[Verify the IP Configuration of Your PC](#)” procedure on page 1-116. If this procedure is unsuccessful, contact your Network Administrator for instructions to correct the IP configuration of your PC.

Verify the IP Configuration of Your PC

-
- Step 1** Open a DOS command window by selecting **Start > Run** from the Start menu.
- Step 2** In the Open field, type **command** and then click **OK**. The DOS command window appears.
- Step 3** At the prompt in the DOS window, type one of the following commands:
- For Windows 98, NT, 2000, and XP, type **ipconfig** and press the **Enter** key.

The Windows IP configuration information appears, including the IP address, subnet mask, and the default gateway.



Note The winipcfg command only returns the information above if you are on a network.

Step 4 At the prompt in the DOS window, type **ping** followed by the IP address shown in the Windows IP configuration information previously displayed.

Step 5 Press the **Enter** key to execute the command.

If the DOS window returns multiple (usually four) replies, the IP configuration is working properly.

If you do not receive a reply, your IP configuration might not be properly set. Contact your Network Administrator for instructions to correct the IP configuration of your PC.

1.9.6 Browser Login Does Not Launch Java

Symptom The message “Loading Java Applet” does not appear and the JRE does not launch during the initial login.

Possible Cause The PC operating system and browser are not properly configured.

Recommended Action Reconfigure the PC operating system java plug-in control panel and the browser settings. Complete the [“Reconfigure the PC Operating System Java Plug-in Control Panel” procedure on page 1-117](#) and the [“Reconfigure the Browser” procedure on page 1-118](#).

Reconfigure the PC Operating System Java Plug-in Control Panel

Step 1 From the Windows start menu, click **Settings > Control Panel**.

Step 2 If **Java Plug-in** does not appear, the JRE might not be installed on your PC:

- a. Run the Cisco ONS 15454 software CD.
- b. Open the *CD-drive:\Windows\JRE* folder.
- c. Double-click the **j2re-5_0-win** icon to run the JRE installation wizard.
- d. Follow the JRE installation wizard steps.

Step 3 From the Windows start menu, click **Settings > Control Panel**.

Step 4 In the Java Plug-in Control Panel window, double-click the **Java Plug-in 5.0** icon.

Step 5 Click the **Advanced** tab on the Java Plug-in Control Panel.

Step 6 Navigate to **C:\ProgramFiles\JavaSoft\JRE\5.0**.

Step 7 Select **JRE 5.0**.

Step 8 Click **Apply**.

Step 9 Close the Java Plug-in Control Panel window.

Reconfigure the Browser

-
- Step 1** From the Start Menu, launch your browser application.
- Step 2** If you are using Netscape Navigator:
- On the Netscape Navigator menu bar, click the **Edit > Preferences** menus.
 - In the Preferences window, click the **Advanced > Proxies** categories.
 - In the Proxies window, click the **Direct connection to the Internet** check box and click **OK**.
 - On the Netscape Navigator menu bar, click the **Edit > Preferences** menus.
 - In the Preferences window, click the **Advanced > Cache** categories.
 - Confirm that the Disk Cache Folder field shows one of the following paths:
 - For Windows 98/ME, **C:\ProgramFiles\Netscape\Communicator\cache**
 - For Windows NT/2000/XP, **C:\ProgramFiles\Netscape\username\Communicator\cache**.
 - If the Disk Cache Folder field is not correct, click **Choose Folder**.
 - Navigate to the file listed in Step f, and click **OK**.
 - Click **OK** on the Preferences window and exit the browser.
- Step 3** If you are using Internet Explorer:
- On the Internet Explorer menu bar, click the **Tools > Internet Options** menus.
 - In the Internet Options window, click the **Advanced** tab.
 - In the Settings menu, scroll down to Java (Sun) and click the **Use Java 2 v1.4.2 for applet (requires restart)** check box.
 - Click **OK** in the Internet Options window and exit the browser.
- Step 4** Temporarily disable any virus-scanning software on the computer. See the [“1.10.4 Browser Stalls When Downloading CTC JAR Files From TCC2/TCC2P Card”](#) section on page 1-123.
- Step 5** Verify that the computer does not have two network interface cards (NICs) installed. If the computer does have two NICs, remove one.
- Step 6** Restart the browser and log on to the ONS 15454.
-

1.9.7 Unable to Verify the NIC Connection on Your PC

Symptom When connecting your PC to the ONS 15454, you are unable to verify that the network interface card (NIC) connection is working properly because the link LED is not illuminated or flashing.

Possible Cause The Category-5 cable is not plugged in properly.

Recommended Action Confirm that both ends of the cable are properly inserted. If the cable is not fully inserted due to a broken locking clip, the cable should be replaced.

Possible Cause The Category-5 cable is damaged.

Recommended Action Ensure that the cable is in good condition. If in doubt, use a known-good cable. Often, cabling is damaged due to pulling or bending. (For information about installing cable, refer to the “Install Cards and Fiber-Optic Cable” chapter in the *Cisco ONS 15454 Procedure Guide*.)

Possible Cause Incorrect type of Category-5 cable is being used.

Recommended Action If you are connecting an ONS 15454 directly to your laptop, a PC, or a router, use a straight-through Category-5 cable. When connecting the ONS 15454 to a hub or a LAN switch, use a crossover Category-5 cable. For details on the types of Category-5 cables, see the [“1.12.2.1 Crimp Replacement LAN Cables” section on page 1-141](#).

Possible Cause The NIC is improperly inserted or installed.

Recommended Action If you are using a Personal Computer Memory Card International Association (PCMCIA)-based NIC, remove and reinsert the NIC to make sure the NIC is fully inserted. (If the NIC is built into the laptop or PC, verify that the NIC is not faulty.)

Possible Cause The NIC is faulty.

Recommended Action Confirm that the NIC is working properly. If you have no issues connecting to the network (or any other node), then the NIC should be working correctly. If you have difficulty connecting a to the network (or any other node), then the NIC might be faulty and needs to be replaced.

1.9.8 Verify PC Connection to the ONS 15454 (ping)

Symptom The TCP/IP connection was established and then lost.

Possible Cause A lost connection between the PC and the ONS 15454.

Recommended Action Use a standard ping command to verify the TCP/IP connection between the PC and the ONS 15454 TCC2/TCC2P card. A ping command should work if the PC connects directly to the TCC2/TCC2P card or uses a LAN to access the TCC2/TCC2P card. Complete the [“Ping the ONS 15454” procedure on page 1-119](#).

Ping the ONS 15454

-
- Step 1** Open a the command prompt:
- If you are using a Microsoft Windows operating system, from the Start Menu choose **Run**, enter **command** in the Open field of the Run dialog box, and click **OK**.
 - If you are using a Sun Solaris operating system, from the Common Desktop Environment (CDE) click the **Personal Application tab** and click **Terminal**.
- Step 2** For both the Sun and Microsoft operating systems, at the prompt enter:
- ```
ping ONS-15454-IP-address
```
- For example:
- ```
ping 198.168.10.10
```

-
- Step 3** If the workstation has connectivity to the ONS 15454, the ping is successful and displays a reply from the IP address. If the workstation does not have connectivity, a “Request timed out” message appears.
 - Step 4** If the ping is successful, it demonstrates that an active TCP/IP connection exists. Restart CTC.
 - Step 5** If the ping is not successful, and the workstation connects to the ONS 15454 through a LAN, check that the workstation’s IP address is on the same subnet as the ONS node.
 - Step 6** If the ping is not successful and the workstation connects directly to the ONS 15454, check that the link light on the workstation’s NIC is illuminated.
-

1.9.9 The IP Address of the Node is Unknown

Symptom The IP address of the node is unknown and you are unable to login.

Possible Cause The node is not set to the default IP address.

Recommended Action Leave one TCC2/TCC2P card in the shelf. Connect a PC directly to the remaining TCC2/TCC2P card and perform a hardware reset of the card. The TCC2/TCC2P card transmits the IP address after the reset to enable you to capture the IP address for login. Complete the [“Retrieve Unknown Node IP Address” procedure on page 1-120](#).

Retrieve Unknown Node IP Address

-
- Step 1** Connect your PC directly to the active TCC2/TCC2P card Ethernet port on the faceplate.
 - Step 2** Start the Sniffer application on your PC.
 - Step 3** Perform a hardware reset by pulling and reseating the active TCC2/TCC2P card.
 - Step 4** After the TCC2/TCC2P card completes resetting, it broadcasts its IP address. The Sniffer software on your PC will capture the IP address being broadcast.
-

1.10 CTC Operation Troubleshooting

This section contains troubleshooting procedures for CTC login or operation problems.

1.10.1 CTC Colors Do Not Appear Correctly on a UNIX Workstation

Symptom When running CTC on a UNIX workstation, the colors do not appear correctly. For example, both major and minor alarms appear in the same color.

Possible Cause When running in 256-color mode on a UNIX workstation, color-intensive applications such as Netscape might use all of the colors.

Recommended Action CTC requires a full 24-color palette to run properly. When logging into CTC on a UNIX workstation, run as many colors as your adapter will support. In addition, you can use the `-install` or the `-ncols 32` command line options to limit the number of colors that Netscape uses. Complete the [“Limit Netscape Colors” procedure on page 1-121](#). If the problem persists after limiting Netscape colors, exit any other color-intensive applications in use.

Limit Netscape Colors

-
- Step 1** Close the current session of Netscape.
- Step 2** Launch Netscape from the command line by entering:
- ```
netscape -install (installs Netscape colors for Netscape use)
```
- or
- ```
netscape -ncols 32 (limits Netscape to 32 colors so that if the requested color is not available, Netscape chooses the closest color option)
```
-

1.10.2 Unable to Launch CTC Help After Removing Netscape

Symptom After removing Netscape and running CTC using Internet Explorer, you are unable to launch CTC Help and receive an “MSIE is not the default browser” error message.

Possible Cause Loss of association between browser and Help files.

Recommended Action When the CTC software and Netscape are installed, the Help files are associated with Netscape by default. When you remove Netscape, the Help files are not automatically associated with Internet Explorer as the default browser. Reset Internet Explorer as the default browser so that CTC associates the Help files to the correct browser. Complete the [“Reset Internet Explorer as the Default Browser for CTC” procedure on page 1-121](#) to associate the CTC Help files to the correct browser.

Reset Internet Explorer as the Default Browser for CTC

-
- Step 1** Open the Internet Explorer browser.
- Step 2** From the menu bar, click **Tools > Internet Options**. The Internet Options window appears.
- Step 3** In the Internet Options window, click the **Programs** tab.

- Step 4** Click the **Internet Explorer should check to see whether it is the default browser** check box.
 - Step 5** Click **OK**.
 - Step 6** Exit any and all open and running CTC and Internet Explorer applications.
 - Step 7** Launch Internet Explorer and open a new CTC session. You should now be able to access the CTC Help.
-

1.10.3 Unable to Change Node View to Network View

Symptom When activating a large, multinode BLSR from Software R3.2 to Software R3.3, some of the nodes appear grayed out. Logging into the new CTC, the user is unable to change node view to network view on any and all nodes, from any workstation. This is accompanied by an “Exception occurred during event dispatching: java.lang.OutOfMemoryError” in the java window.

Possible Cause The large, multinode BLSR requires more memory for the graphical user interface (GUI) environment variables.

Recommended Action Reset the system or user CTC_HEAP environment variable to increase the memory limits. Complete the [“Reset the CTC_HEAP Environment Variable for Windows” procedure on page 1-122](#) or the [“Reset the CTC_HEAP Environment Variable for Solaris” procedure on page 1-122](#) to enable the CTC_HEAP variable change.



Note This problem typically affects large networks where additional memory is required to manage large numbers of nodes and circuits.

Reset the CTC_HEAP Environment Variable for Windows

- Step 1** Exit any and all open and running CTC and Netscape applications.
 - Step 2** From the Windows Desktop, right-click **My Computer** and choose **Properties** in the shortcut menu.
 - Step 3** In the System Properties window, click the **Advanced** tab.
 - Step 4** Click **Environment Variables** to open the Environment Variables window.
 - Step 5** Click **New** under the User variables field or the System variables field.
 - Step 6** Enter **CTC_HEAP** in the Variable Name field.
 - Step 7** Enter **256** in the Variable Value field, and then click **OK** to create the variable.
 - Step 8** Click **OK** in the Environment Variables window to accept the changes.
 - Step 9** Click **OK** in the System Properties window to accept the changes.
Restart the browser and CTC software.
-

Reset the CTC_HEAP Environment Variable for Solaris

- Step 1** From the user shell window, kill any CTC applications.

- Step 2** Kill any Netscape applications.
- Step 3** In the user shell window, set the environment variable to increase the heap size:
- ```
% setenv CTC_HEAP 256
```
- Step 4** Restart the browser and CTC software in the same user shell window.
- 

## 1.10.4 Browser Stalls When Downloading CTC JAR Files From TCC2/TCC2P Card

**Symptom** The browser stalls or hangs when downloading a CTC Java archive (JAR) file from the TCC2/TCC2P card.

**Possible Cause** McAfee VirusScan software might be interfering with the operation. The problem occurs when the VirusScan Download Scan is enabled on McAfee VirusScan 4.5 or later.

**Recommended Action** Disable the VirusScan Download Scan feature. Complete the [“Disable the VirusScan Download Scan” procedure on page 1-123](#).

### Disable the VirusScan Download Scan

---

- Step 1** From the Windows Start menu, choose **Programs > Network Associates > VirusScan Console**.
- Step 2** Double-click the **VShield** icon listed in the VirusScan Console dialog box.
- Step 3** Click **Configure** on the lower part of the Task Properties window.
- Step 4** Click the **Download Scan** icon on the left of the System Scan Properties dialog box.
- Step 5** Uncheck the **Enable Internet download scanning** check box.
- Step 6** Click **Yes** when the warning message appears.
- Step 7** Click **OK** in the System Scan Properties dialog box.
- Step 8** Click **OK** in the Task Properties window.
- Step 9** Close the McAfee VirusScan window.
- 

## 1.10.5 CTC Does Not Launch

**Symptom** CTC does not launch; usually an error message appears before the login window appears.

**Possible Cause** The Netscape browser cache might point to an invalid directory.

**Recommended Action** Redirect the Netscape cache to a valid directory. Complete the [“Redirect the Netscape Cache to a Valid Directory” procedure on page 1-124](#).

## Redirect the Netscape Cache to a Valid Directory

- 
- Step 1** Launch Netscape.
  - Step 2** Open the **Edit** menu.
  - Step 3** Choose **Preferences**.
  - Step 4** Under the Category column on the left side, expand the **Advanced** category and choose the **Cache** tab.
  - Step 5** Change your disk cache folder to point to the cache file location.

The cache file location is usually C:\ProgramFiles\Netscape\Users\yourname\cache. The *yourname* segment of the file location is often the same as the user name.

---

## 1.10.6 Slow CTC Operation or Login Problems

**Symptom** You experience slow CTC operation or have problems logging into CTC.

**Possible Cause** The CTC cache file might be corrupted or might need to be replaced.

**Recommended Action** Search for and delete cache files. This operation forces the ONS 15454 to download a new set of Java archive (JAR) files to your computer hard drive. Complete the [“Delete the CTC Cache File Automatically”](#) procedure on page 1-124 or the [“Delete the CTC Cache File Manually”](#) procedure on page 1-125.

### Delete the CTC Cache File Automatically



**Caution**

All running sessions of CTC must be halted before deleting the CTC cache. Deleting CTC cache might cause any CTC running on this system to behave in an unexpected manner.

---

- 
- Step 1** Enter an ONS 15454 IP address into the browser URL field. The initial browser window shows a **Delete CTC Cache** button.
  - Step 2** Close all open CTC sessions and browser windows. The PC operating system does not allow you to delete files that are in use.
  - Step 3** Click **Delete CTC Cache** on the initial browser window to clear the CTC cache. [Figure 1-48](#) shows the Delete CTC Cache window.

Figure 1-48 Deleting the CTC Cache

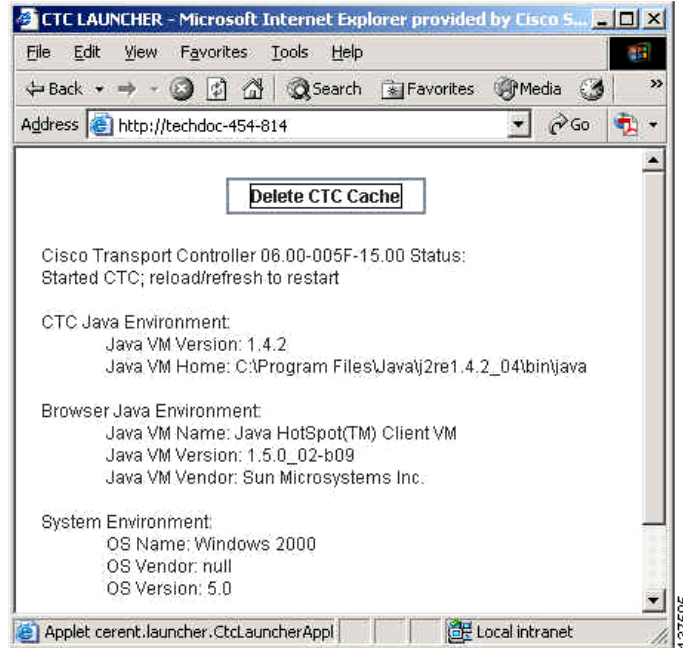

## Delete the CTC Cache File Manually



### Caution

All running sessions of CTC must be halted before deleting the CTC cache. Deleting the CTC cache might cause any CTC running on this system to behave in an unexpected manner.

- Step 1** To delete the JAR files manually, from the Windows Start menu choose **Search > For Files or Folders**.
- Step 2** Enter **ctc\*.jar** or **cms\*.jar** in the Search for files or folders named field in the Search Results dialog box and click **Search Now**.
- Step 3** Click the **Modified** column in the Search Results dialog box to find the JAR files that match the date when you downloaded the files from the TCC2/TCC2P.
- Step 4** Highlight the files and press the keyboard **Delete** key.
- Step 5** Click **Yes** in the Confirm dialog box.

## 1.10.7 Node Icon is Gray on CTC Network View

**Symptom** The CTC network view shows one or more node icons as gray in color and without a node name.

**Possible Cause** Different CTC releases do not recognize each other.

**Recommended Action** Correct the core version build as described in the [“1.10.10 Different CTC Releases Do Not Recognize Each Other”](#) section on page 1-128.

**Possible Cause** Username and password do not match.

**Recommended Action** Correct the username and password as described in the [“1.10.11 Username or Password Do Not Match”](#) section on page 1-129.

**Possible Cause** No IP connectivity between nodes.

**Recommended Action** Usually accompanied by Ethernet-specific alarms. Verify the Ethernet connections as described in the [“1.10.16 Ethernet Connections”](#) section on page 1-131.

**Possible Cause** A lost DCC connection.

**Recommended Action** Usually accompanied by an embedded operations channel (EOC) alarm. Clear the EOC alarm and verify the DCC connection as described in the [“EOC”](#) alarm.

## 1.10.8 CTC Cannot Launch Due to Applet Security Restrictions

**Symptom** The error message “Unable to launch CTC due to applet security restrictions” appears after you enter the IP address in the browser window.

**Possible Cause** You are logging into a node running CTC Software R4.0 or earlier. Releases earlier than R4.1 require a modification to the java.policy file so that CTC JAR files can be downloaded to the computer. The modified java.policy file might not exist on the computer.

**Recommended Action** Install the software CD for the release of the node you are logging into. Run the CTC Setup Wizard (double-click **Setup.exe**). Choose **Custom installation**, then choose the Java Policy option. For additional information, refer to the CTC installation information in the “Connect the PC and Log into the GUI” chapter of the *Cisco ONS 15454 Procedure Guide*. If the software CD is not available, you must manually edit the java.policy file on your computer. Complete the [“Manually Edit the java.policy File”](#) procedure on page 1-126.

### Manually Edit the java.policy File

**Step 1** Search your computer for java.policy file and open it with a text editor (Notepad or Wordpad).

**Step 2** Verify that the end of this file has the following lines:

```
// Insert this into the system-wide or a per-user java.policy file.
// DO NOT OVERWRITE THE SYSTEM-WIDE POLICY FILE--ADD THESE LINES!

grant codeBase "http://*/fs/LAUNCHER.jar {
```

```
permission java.security.AllPermission;
};
```

**Step 3** If these five lines are not in the file, enter them manually.

**Step 4** Save the file and restart Netscape.

CTC should now start correctly.

**Step 5** If the error message is still reported, save the java.policy file as **.java.policy**. On Win98/2000/XP PCs, save the file to the C:\Windows folder. On Windows NT 4.0 or later PCs, save the file to all of the user folders on that PC, for example, C:\Winnt\profiles\joeuser.

## 1.10.9 Java Runtime Environment Incompatible

**Symptom** The CTC application does not run properly.

**Possible Cause** The compatible Java 2 JRE is not installed.

**Recommended Action** The JRE contains the Java virtual machine, runtime class libraries, and Java application launcher that are necessary to run programs written in the Java programming language. The ONS 15454 CTC is a Java application. A Java application, unlike an applet, cannot rely completely on a web browser for installation and runtime services. When you run an application written in the Java programming language, you need the correct JRE installed. The correct JRE for each CTC software release is included on the Cisco ONS 15454 software CD. Complete the [“Launch CTC to Correct the Core Version Build” procedure on page 1-128](#). If you are running multiple CTC software releases on a network, the JRE installed on the computer must be compatible with the different software releases. [Table 1-3](#) shows JRE compatibility with ONS 15454 software releases.

**Table 1-3** JRE Compatibility

| Software Release             | JRE 1.2.2 Compatible | JRE 1.3 Compatible | JRE 1.4 Compatible | JRE 1.4.2 Compatible <sup>1</sup> | JRE 5.0 Compatible |
|------------------------------|----------------------|--------------------|--------------------|-----------------------------------|--------------------|
| ONS 15454 R2.2.1 and earlier | Yes                  | No                 | No                 | No                                | No                 |
| ONS 15454 R2.2.2             | Yes                  | Yes                | No                 | No                                | No                 |
| ONS 15454 R3.0               | Yes                  | Yes                | No                 | No                                | No                 |
| ONS 15454 R3.1               | Yes                  | Yes                | No                 | No                                | No                 |
| ONS 15454 R3.2               | Yes                  | Yes                | No                 | No                                | No                 |
| ONS 15454 R3.3               | Yes                  | Yes                | No                 | No                                | No                 |
| ONS 15454 R3.4               | No                   | Yes                | No                 | No                                | No                 |
| ONS 15454 R4.0 <sup>2</sup>  | No                   | Yes                | No                 | No                                | No                 |
| ONS 15454 R4.1               | No                   | Yes                | No                 | No                                | No                 |
| ONS 15454 R4.5               | No                   | Yes                | No                 | No                                | No                 |
| ONS 15454 R4.6               | No                   | Yes                | Yes                | No                                | No                 |
| ONS 15454 R4.7               | No                   | Yes                | Yes                | No                                | No                 |

Table 1-3 JRE Compatibility (continued)

| Software Release | JRE 1.2.2 Compatible | JRE 1.3 Compatible | JRE 1.4 Compatible | JRE 1.4.2 Compatible <sup>1</sup> | JRE 5.0 Compatible |
|------------------|----------------------|--------------------|--------------------|-----------------------------------|--------------------|
| ONS 15454 R5.0   | No                   | Yes                | Yes                | Yes                               | No                 |
| ONS 15454 R6.0   | No                   | No                 | Yes                | Yes                               | No                 |
| ONS 15454 R7.0   | No                   | No                 | No                 | Yes                               | Yes                |
| ONS 15454 R7.2   | No                   | No                 | No                 | Yes                               | Yes                |
| ONS 15454 R8.0   | No                   | No                 | No                 | No                                | Yes                |

1. JRE 1.4.2 is the recommended version and is provided on the software CD.
2. R4.0 notifies you if an earlier JRE version is running on your PC or UNIX workstation.

## Launch CTC to Correct the Core Version Build

- 
- Step 1** Exit the current CTC session and completely close the browser.
- Step 2** Start the browser.
- Step 3** Enter the ONS 15454 IP address of the node that reported the alarm. This can be the original IP address you logged in with or an IP address other than the original.
- Step 4** Log into CTC. The browser downloads the JAR file from CTC.
- 

## 1.10.10 Different CTC Releases Do Not Recognize Each Other

**Symptom** Different CTC releases do not recognize each other. This situation is often accompanied by the INCOMPATIBLE-SW alarm.

**Possible Cause** The software loaded on the connecting workstation and the software on the TCC2/TCC2P card are incompatible.

**Recommended Action** This occurs when the TCC2/TCC2P software is upgraded but the PC has not yet upgraded the compatible CTC JAR file. It also occurs on login nodes with compatible software that encounter other nodes in the network that have a newer software version. Complete the [“Launch CTC to Correct the Core Version Build” procedure on page 1-128](#).



**Note** Remember to always log into the ONS node with the latest CTC core version first. If you initially log into an ONS node running a CTC core version of 2.2 or lower and then attempt to log into another ONS node in the network running a higher CTC core version, the lower version node does not recognize the new node.

---

## Launch CTC to Correct the Core Version Build

- 
- Step 1** Exit the current CTC session and completely close the browser.



- Step 2** Start the browser.
- Step 3** Enter the ONS 15454 IP address of the node that reported the alarm. This can be the original IP address you logged on with or an IP address other than the original.
- Step 4** Log into CTC. The browser downloads the JAR file from CTC.
- 

## 1.10.11 Username or Password Do Not Match

**Symptom** A username/password mismatch often occurs concurrently with a NOT-AUTHENTICATED alarm.

**Possible Cause** The username or password entered does not match the information stored in the TCC2/TCC2P.

**Recommended Action** All ONS nodes must have the same username and password created to display every ONS node in the network. You can also be locked out of certain ONS nodes on a network if your username and password were not created on those specific ONS nodes. For initial login to the ONS 15454, enter the CISCO15 user name in capital letters and click **Login** and use the password “otbu+1,” which is case-sensitive. Complete the [“Verify Correct Username and Password” procedure on page 1-129](#). If the node has been configured for Radius authentication, the username and password are verified against the Radius server database rather than the security information in the local node database. For more information about Radius security, refer to the “Security” chapter in the *Cisco ONS 15454 Reference Manual*.

### Verify Correct Username and Password

- Step 1** Ensure that your keyboard Caps Lock key is not turned on and affecting the case-sensitive entry of the username and password.
- Step 2** Contact your system administrator to verify the username and password.
- Step 3** Call Cisco Technical Support at 1 800 553-2447 to have them enter your system and create a new user name and password.
- 

## 1.10.12 No IP Connectivity Exists Between Nodes

**Symptom** No IP connectivity exists between nodes. The nodes have a gray icon. This problem is usually accompanied by alarms.

**Possible Cause** A lost Ethernet connection.

**Recommended Action** Usually is accompanied by Ethernet-specific alarms. Verify the Ethernet connections as described in the [“1.10.16 Ethernet Connections” section on page 1-131](#).

## 1.10.13 DCC Connection Lost

**Symptom** DCC connection is lost. The node usually has alarms and the nodes in the network view have a gray icon. This symptom is usually accompanied by an EOC alarm.

**Possible Cause** A lost DCC connection.

**Recommended Action** Usually accompanied by an EOC alarm. Clear the EOC alarm and verify the DCC connection as described in the “[EOC](#)” alarm.

## 1.10.14 “Path in Use” Error When Creating a Circuit

**Symptom** While creating a circuit, you get a “Path in Use” error that prevents you from completing the circuit creation.

**Possible Cause** Another user has already selected the same source port to create another circuit.

**Recommended Action** CTC does not remove a card or port from the available list until a circuit is completely provisioned. If two users simultaneously select the same source port to create a circuit, the first user to complete circuit provisioning gets use of the port. The other user gets the “Path in Use” error. Cancel the circuit creation and start over, or click **Back** until you return to the initial circuit creation window. The source port that was previously selected no longer appears in the available list because it is now part of a provisioned circuit. Select a different available port and begin the circuit creation process again.

## 1.10.15 Calculate and Design IP Subnets

**Symptom** You cannot calculate or design IP subnets on the ONS 15454.

**Possible Cause** The IP capabilities of the ONS 15454 require specific calculations to properly design IP subnets.

**Recommended Action** Cisco provides a free online tool to calculate and design IP subnets.

Go to <http://www.cisco.com/cgi-bin/Support/IpSubnet/home.pl>.

For information about ONS 15454 IP capability, refer to the “Management Network Connectivity” chapter in the *Cisco ONS 15454 Reference Manual*.

## 1.10.16 Ethernet Connections

**Symptom** Ethernet connections appear to be broken or are not working properly.

**Possible Cause** Improperly seated connections.

**Possible Cause** Incorrect connections.

**Recommended Action** You can fix most connectivity problems in an Ethernet network by following a few guidelines. See [Figure 1-49](#) when using the steps in the “Verify Ethernet Connections” procedure on page 1-131.

**Figure 1-49 Ethernet Connectivity Reference**

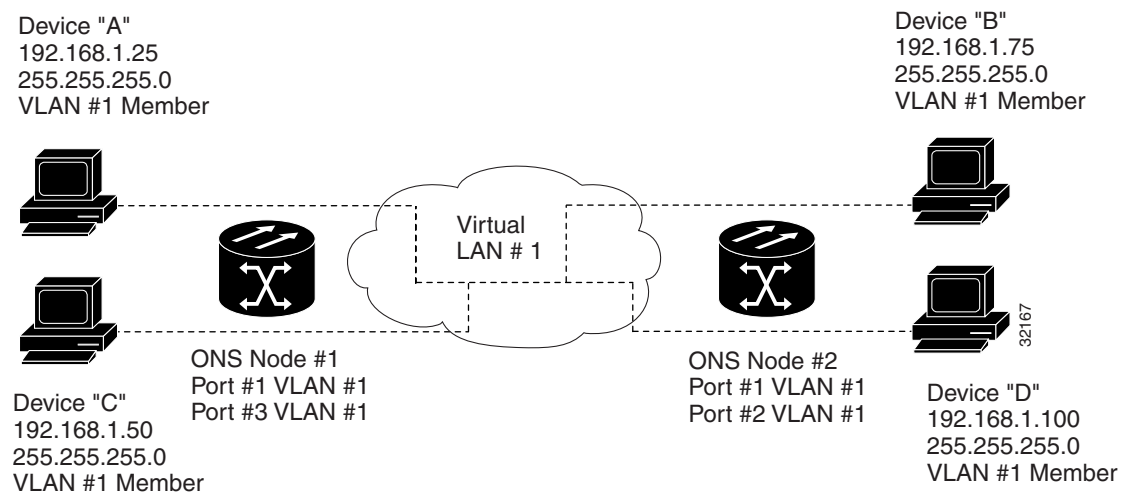

### Verify Ethernet Connections

- Step 1** Verify that the alarm filter is turned OFF.
- Step 2** Check for SONET and DWDM alarms on the STS that carries the VLAN Ethernet circuit. Clear any alarms by looking them up in [Chapter 2, “Alarm Troubleshooting.”](#)
- Step 3** Check for Ethernet-specific alarms. Clear any raised alarms by looking up that alarm in [Chapter 2, “Alarm Troubleshooting.”](#)
- Step 4** Verify that the ACT LED on the Ethernet card is green.
- Step 5** Verify that Ports 1 and 3 on ONS 15454 #1 and Ports 1 and 2 on ONS 15454 #2 have green link-integrity LEDs illuminated.
- Step 6** If no green link-integrity LED is illuminated for any of these ports:
  - a. Verify physical connectivity between the ONS 15454s and the attached device.
  - b. Verify that the ports are enabled on the Ethernet cards.
  - c. Verify that you are using the proper Ethernet cable and that it is wired correctly, or replace the cable with a known-good Ethernet cable.

- d. Check the status LED on the Ethernet card faceplate to ensure the card booted up properly. This LED should be steady green. If necessary, remove and reinsert the card and allow it to reboot.
  - e. It is possible that the Ethernet port is functioning properly but the link LED itself is broken. Complete the [“Verify General Card LED Operation” procedure on page 1-108](#).
- Step 7** Verify connectivity between device A and device C by pinging between these locally attached devices. Complete the [“1.9.8 Verify PC Connection to the ONS 15454 \(ping\)” procedure on page 1-119](#). If the ping is unsuccessful:
- a. Verify that device A and device C are on the same IP subnet.
  - b. Open the Ethernet card in CTC card view and click the **Provisioning > VLAN** tabs to verify that both Port 1 and Port 3 on the card are assigned to the same VLAN.
  - c. If a port is not assigned to the correct VLAN, click that port column in the VLAN row and set the port to Tagged or Untag. Click **Apply**.
- Step 8** Repeat [Step 7](#) for devices B and D.
- Step 9** Verify that the Ethernet circuit that carries VLAN #1 is provisioned and that ONS 15454 #1 and ONS 15454 #2 ports also use VLAN #1.
- 

## 1.10.17 VLAN Cannot Connect to Network Device from Untag Port

**Symptom** Networks that have a VLAN with one ONS 15454 Ethernet card port set to Tagged and one ONS 15454 Ethernet card set to Untag might have difficulty implementing Address Resolution Protocol (ARP) for a network device attached to the Untag port ([Figure 1-50](#)). They might also see a higher than normal runt packets count at the network device attached to the Untag port. This symptom/limitation also exists when ports within the same card or ports within the same chassis are put on the same VLAN, with a mix of tagged and untagged.

**Possible Cause** The Tagged ONS 15454 adds the IEEE 802.1Q tag and the Untag ONS 15454 removes the Q-tag without replacing the bytes. The NIC of the network device categorizes the packet as a runt and drops the packet.

**Possible Cause** Dropped packets can also occur when ARP attempts to match the IP address of the network device attached to the Untag port with the physical MAC address required by the network access layer.

**Recommended Action** The solution is to set both ports in the VLAN to Tagged to stop the stripping of the 4 bytes from the data packet and prevent the NIC card in the network access device from recognizing the packet as a runt and dropping it. Network devices with IEEE 802.1Q-compliant NIC cards accept the tagged packets. Network devices with non IEEE 802.1Q compliant NIC cards still drop these tagged packets. The solution might require upgrading network devices with non-IEEE 802.1Q compliant NIC cards to IEEE 802.1Q compliant NIC cards. You can also set both ports in the VLAN to Untag, but you will lose IEEE 802.1Q compliance.

Figure 1-50 VLAN with Ethernet Ports at Tagged and Untag

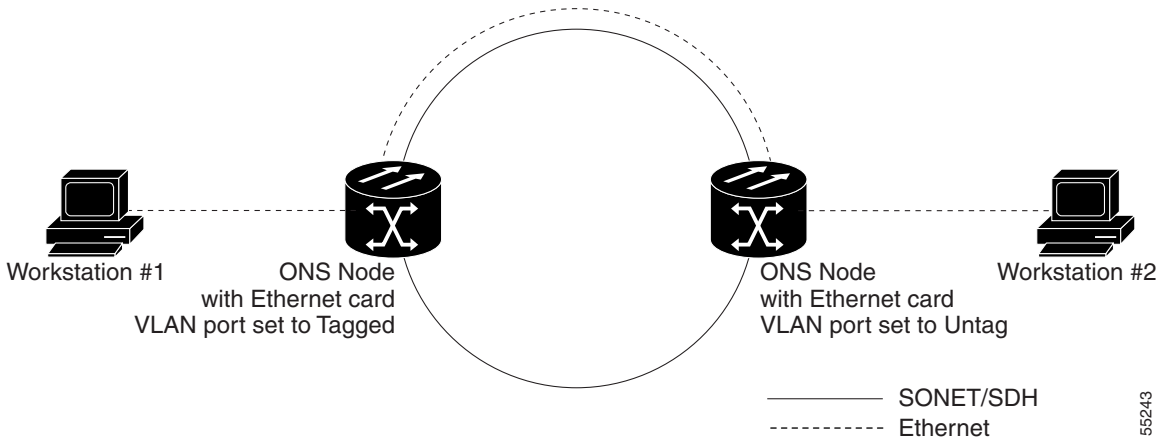

55243

## Change VLAN Port Tagged and Untag Settings

- Step 1** Open the CTC card view for the Ethernet card involved in the problem VLAN.
- Step 2** Click the **Provisioning > Ether VLAN** tabs (Figure 1-51).

Figure 1-51 Configuring VLAN Membership for Individual Ethernet Ports

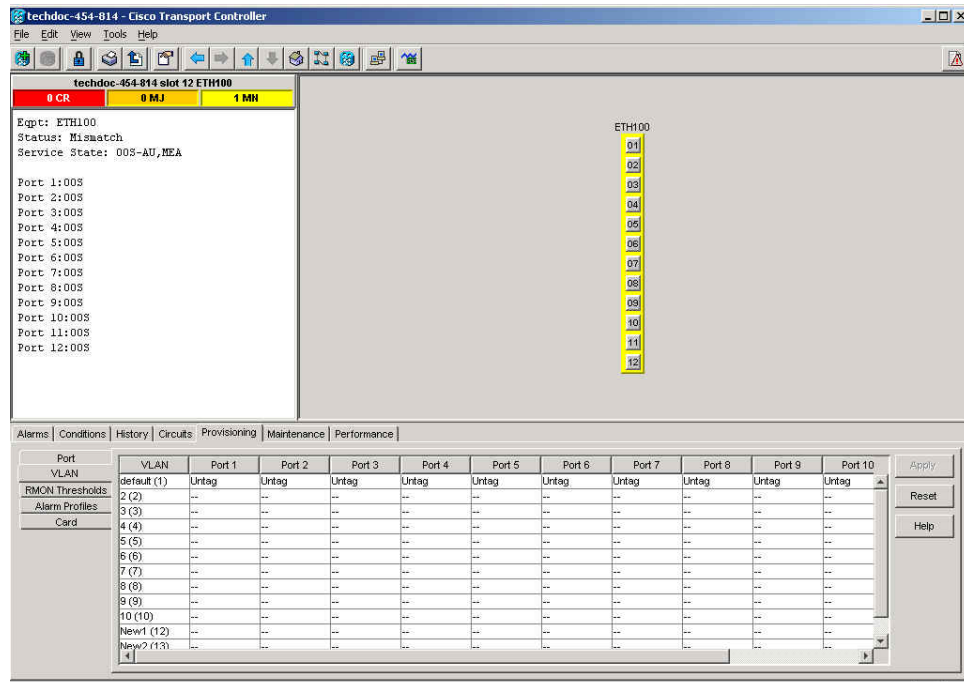

- Step 3** If the port is set to **Tagged**, continue to look at other cards and their ports in the VLAN until you find the port that is set to **Untag**.
- Step 4** At the VLAN port set to **Untag**, click the port and choose **Tagged**.

137589



---

**Note** The attached external devices must recognize IEEE 802.1Q VLANs.

---

**Step 5** After each port is in the appropriate VLAN, click **Apply**.

---

## 1.11 Circuits and Timing

This section provides solutions to circuit creation and reporting errors, as well as common timing reference errors and alarms.

### 1.11.1 OC-N Circuit Transitions to Partial State

**Symptom** An automatic or manual transition of a circuit from one state to another state results in the OOS-PARTIAL status, which indicates that not all OC-N connections in the circuit are in the IS-NR service state.

**Possible Cause** During a manual transition, CTC cannot communicate with one of the nodes or one of the nodes is on a version of software that does not support the new state model.

**Recommended Action** Repeat the manual transition operation. If the partial state persists, determine which node in the circuit is not changing to the desired state. Complete the [“View the State of OC-N Circuit Nodes” procedure on page 1-134](#). Log into the circuit node that did not change to the desired state and determine the version of software. If the software on the node is Software R3.3 or earlier, upgrade the software. Refer to the release-specific software upgrade document for procedures.



---

**Note** If the node software cannot be upgraded to R4.0, the partial state condition can be avoided by using only the circuit state supported in the earlier software version.

---

**Possible Cause** During an automatic transition, some path-level defects and/or alarms were detected on the circuit.

**Possible Cause** One end of the circuit is not properly terminated.

**Recommended Action** Determine which node in the circuit is not changing to the desired state. Complete the [“View the State of OC-N Circuit Nodes” procedure on page 1-134](#). Log onto the circuit node that did not change to the desired state and examine the circuit for path-level defects, improper circuit termination, or alarms. See [Chapter 2, “Alarm Troubleshooting,”](#) for procedures to clear alarms. Refer to the “Manage Circuits” chapter in the *Cisco ONS 15454 Procedure Guide* for instructions to change circuit configuration settings. Resolve and clear the defects and/or alarms on the circuit node and verify that the circuit transitions to the desired state.

### View the State of OC-N Circuit Nodes

---

**Step 1** Click the **Circuits** tab.

- Step 2** From the Circuits tab list, select the circuit with the \*\_PARTIAL status condition.
- Step 3** Click **Edit**. The Edit Circuit window appears.
- Step 4** In the Edit Circuit window, click the **State** tab (if you are viewing a SONET circuit).  
The State tab window lists the Node, End A, End B, CRS Admin State, and CRS Service State for each of the nodes in the circuit.
- 

## 1.11.2 AIS-V on DS3XM-6 or DS3XM-12 Unused VT Circuits

**Symptom** An incomplete circuit path causes an AIS.

**Possible Cause** The port on the reporting node is in-service but a node upstream on the circuit does not have an OC-N port in service.

**Recommended Action** An AIS-V indicates that an upstream failure occurred at the virtual tributary (VT) layer. AIS-V alarms also occur on DS3XM-6 and DS3XM-12 VT circuits that are not carrying traffic and on stranded bandwidth. Complete the [“Clear AIS-V on DS3XM-6 or DS3XM-12 Unused VT Circuits” procedure on page 1-135](#).

### Clear AIS-V on DS3XM-6 or DS3XM-12 Unused VT Circuits

---

- Step 1** Determine the affected port.
- Step 2** Record the node ID, slot number, port number, or VT number.
- Step 3** Create a unidirectional VT circuit from the affected port back to itself, such as Source node/Slot 2/Port 2/VT 13 cross connected to Source node/Slot 2/Port 2/VT 13.
- Step 4** Uncheck the **Bidirectional** check box in the circuit creation window.
- Step 5** Give the unidirectional VT circuit an easily recognizable name, such as delete me.
- Step 6** Open the DS3XM-6 card in CTC card view. Click the **Maintenance > DS1** tabs.
- Step 7** Locate the VT that is reporting the alarm (for example, DS3 #2, DS1 #13).
- Step 8** From the Loopback Type list, choose **Facility** and click **Apply**.
- Step 9** Click **Circuits**.
- Step 10** Find the one-way circuit you created in [Step 3](#). Select the circuit and click **Delete**. Do not check any check boxes.
- Step 11** Click **Yes** in the Delete Confirmation dialog box.
- Step 12** Open the DS3XM-6 or DS3XM-12 card in CTC card view. Click **Maintenance > DS1** tabs.
- Step 13** Locate the VT in Facility Loopback.
- Step 14** From the Loopback Type list, choose **None** and then click **Apply**.
- Step 15** Click the **Alarms** tab and verify that the AIS-V alarms have cleared.
- Step 16** Repeat this procedure for all the AIS-V alarms on the DS3XM-6 or DS3XM-12 cards.
-

## 1.11.3 Circuit Creation Error with VT1.5 Circuit

**Symptom** You receive an “Error while finishing circuit creation. Unable to provision circuit. Unable to create connection object at *node\_name*” message when trying to create a VT1.5 circuit in CTC.

**Possible Cause** You might have run out of bandwidth on the VT cross-connect matrix at the ONS 15454 indicated in the error message.

**Recommended Action** The matrix has a maximum capacity of 336 bidirectional VT1.5 cross-connects. Certain configurations exhaust VT capacity with less than 336 bidirectional VT1.5s in a BLSR or less than 224 bidirectional VT1.5s in a path protection or 1+1 protection group. Refer to the “Circuits and Tunnels” chapter in the *Cisco ONS 15454 Reference Manual* for more information.

## 1.11.4 Unable to Create Circuit From DS-3 Card to DS3XM-6 or DS3XM-12 Card

**Symptom** You cannot create a circuit from a DS-3 card to a DS3XM-6 or DS3XM-12 card.

**Possible Cause** A DS-3 card and a DS3XM-6 or DS3XM-12 card have different functions.

**Recommended Action** A DS3XM-6 card converts each of its six DS-3 interfaces into 28 DS-1s for cross-connection through the network. The DS3XM-12 converts each of its 12 interfaces into up to 48 DS-1s. Thus, you can create a circuit from a DS3XM-6 or DS3XM-12 card to a DS-1 card, but not from a DS3XM card to a DS-3 card. These differences are evident in the STS path overhead. The DS-3 card uses asynchronous mapping for DS-3, which is indicated by the C2 byte in the STS path overhead that has a hex code of 04. A DS3XM-6 or DS3XM-12 has a VT payload with a C2 hex value of 02.



**Note** You can find instructions for creating circuits in the “Create Circuits and VT Tunnels” chapter of the *Cisco ONS 15454 Procedure Guide*.

## 1.11.5 DS-3 Card Does Not Report AIS-P From External Equipment

**Symptom** A DS3-12, DS3N-12, DS3-12E, or DS3N-12E card does not report STS AIS-P from the external equipment/line side.

**Possible Cause** The card is functioning as designed.

**Recommended Action** This card terminates the port signal at the backplane so STS AIS-P is not reported from the external equipment/line side. DS3-12, DS3N-12, DS3-12E, and DS3N-12E cards have DS3 header monitoring functionality, which allows you to view PM on the DS3 path. Nevertheless, you cannot view AIS-P on the STS path. For more information about the PM capabilities of the DS3-12, DS3N-12, DS3-12E or DS3N-12E cards, refer to the “Performance Monitoring” chapter in the *Cisco ONS 15454 Reference Manual*.



## 1.11.6 OC-3 and DCC Limitations

**Symptom** Limitations to OC-3 and DCC usage.

**Possible Cause** OC-3 and DCC have limitations for the ONS 15454.

**Recommended Action** For an explanation of OC-3 and DCC limitations, refer to the “Circuits and Tunnels” chapter in the *Cisco ONS 15454 Reference Manual*.

## 1.11.7 ONS 15454 Switches Timing Reference

**Symptom** Timing references switch when one or more problems occur.

**Possible Cause** The optical or BITS input is receiving loss of signal (LOS), loss of frame (LOF), or AIS alarms from its timing source.

**Possible Cause** The optical or building integrated timing supply (BITS) input is not functioning.

**Possible Cause** The synchronization status messaging (SSM) message is set to Do Not Use for Synchronization (DUS).

**Possible Cause** SSM indicates a Stratum 3 or lower clock quality.

**Possible Cause** The input frequency is off by more than 15 ppm.

**Possible Cause** The input clock wanders and has more than three slips in 30 seconds.

**Possible Cause** A bad timing reference existed for at least two minutes.

**Recommended Action** The ONS 15454 internal clock operates at a Stratum 3E level of accuracy. This gives the ONS 15454 a free-running synchronization accuracy of  $\pm 4.6$  ppm and a holdover stability of less than 255 slips in the first 24 hours or  $3.7 \times 10^{-7}$ /day, including temperature. ONS 15454 free-running synchronization relies on the Stratum 3 internal clock. Over an extended time period, using a higher quality Stratum 1 or Stratum 2 timing source results in fewer timing slips than a lower quality Stratum 3 timing source.

## 1.11.8 Holdover Synchronization Alarm

**Symptom** The clock is running at a different frequency than normal and the “[HLDOVRSYNC](#)” alarm appears.

**Possible Cause** The last reference input has failed.

**Recommended Action** The clock is running at the frequency of the last known-good reference input. This alarm is raised when the last reference input fails. See the “[HLDOVRSYNC](#)” alarm on [page 2-127](#) for a detailed description.

**Note**

The ONS 15454 supports holdover timing per Telcordia GR-436 when provisioned for external (BITS) timing.

## 1.11.9 Free-Running Synchronization Mode

**Symptom** The clock is running at a different frequency than normal and the “FRNGSYNC” alarm appears.

**Possible Cause** No reliable reference input is available.

**Recommended Action** The clock is using the internal oscillator as its only frequency reference. This occurs when no reliable, prior timing reference is available. See the “FRNGSYNC” condition on page 2-115 for a detailed description.

## 1.11.10 Daisy-Chaind BITS Not Functioning

**Symptom** You are unable to daisy chain the BITS sources.

**Possible Cause** Daisy-chained BITS sources are not supported on the ONS 15454.

**Recommended Action** Daisy-chained BITS sources cause additional wander buildup in the network and are therefore not supported. Instead, use a timing signal generator to create multiple copies of the BITS clock and separately link them to each ONS 15454.

## 1.11.11 Blinking STAT LED after Installing a Card

**Symptom** After installing a card, the STAT LED blinks continuously for more than 60 seconds.

**Possible Cause** The card cannot boot because it failed the Power On Shelf Test (POST) diagnostics.

**Recommended Action** The blinking STAT LED indicates that POST diagnostics are being performed. If the LED continues to blink more than 60 seconds, the card has failed the POST diagnostics test and has failed to boot. If the card has truly failed, an “EQPT” alarm is raised against the slot number with an “Equipment Failure” description. Check the alarm tab for this alarm to appear for the slot where the card was installed. To attempt recovery, remove and reinstall the card and observe the card boot process. If the card fails to boot, replace the card. Complete the “Physically Replace a Traffic Card” procedure on page 2-274.

## 1.12 Fiber and Cabling

This section explains problems typically caused by cabling connectivity errors. It also includes instructions for crimping Category-5 cable and lists the optical fiber connectivity levels.

## 1.12.1 Bit Errors Appear for a Traffic Card

**Symptom** A traffic card has multiple bit errors.

**Possible Cause** Faulty cabling or low optical-line levels.

**Recommended Action** Bit errors on line (traffic) cards usually originate from cabling problems or low optical-line levels. The errors can be caused by synchronization problems, especially if pointer justification (PJ) errors are reported. Moving cards into different error-free slots will isolate the cause. Use a test set whenever possible because the cause of the errors could be external cabling, fiber, or external equipment connecting to the ONS 15454. Troubleshoot low optical levels using the “[1.12.2 Faulty Fiber-Optic Connections](#)” section on page 1-139.

## 1.12.2 Faulty Fiber-Optic Connections

**Symptom** A line card has multiple SONET/DWDM alarms and/or signal errors.

**Possible Cause** Faulty fiber-optic connections.

**Recommended Action** Faulty fiber-optic connections can be the source of SONET/DWDM alarms and signal errors. Complete the “[Verify Fiber-Optic Connections](#)” procedure on page 1-139.

**Possible Cause** Faulty Category-5 cables.

**Recommended Action** Faulty Category-5 cables can be the source of SONET/DWDM alarms and signal errors. Complete the “[1.12.2.1 Crimp Replacement LAN Cables](#)” section on page 1-141.

**Possible Cause** Faulty GBICs.

**Recommended Action** Faulty GBICs can be the source of SONET/DWDM alarms and signal errors. See the “[1.12.2.2 Replace Faulty GBIC, SFP, or XFP Connectors](#)” section on page 1-143.



Warning

**Invisible laser radiation may be emitted from disconnected fibers or connectors. Do not stare into beams or view directly with optical instruments.** Statement 272



Warning

**Laser radiation presents an invisible hazard, so personnel should avoid exposure to the laser beam. Personnel must be qualified in laser safety procedures and must use proper eye protection before working on this equipment.** Statement 300

## Verify Fiber-Optic Connections

**Step 1** Ensure that a single-mode fiber connects to the ONS 15454 OC-N card.



**Note**

SM or SM Fiber should be printed on the fiber span cable. ONS 15454 OC-N cards do not use multimode fiber.

- Step 2** Ensure that the connector keys on the SC fiber connector are properly aligned and locked.
- Step 3** Check that the single-mode fiber power level is within the specified range:
- Remove the Rx end of the suspect fiber.
  - Connect the Rx end of the suspect fiber to a fiber-optic power meter, such as a GN Nettek LP-5000.
  - Determine the power level of fiber with the fiber-optic power meter.
  - Verify that the power meter is set to the appropriate wavelength for the OC-N card being tested (either 1310 nm or 1550 nm depending on the specific card).
  - Verify that the power level falls within the range specified for the card if it is an OC-N card; see the [“1.12.3 OC-N Card Transmit and Receive Levels”](#) section on page 1-145.
- Step 4** If the power level falls below the specified range for the OC-N card:
- Clean or replace the fiber patch cords. Clean the fiber according to site practice or, if none exists, follow the procedure in the “Maintain the Node” chapter in the *Cisco ONS 15454 Procedure Guide*. If possible, do this for the OC-N card you are working on and the far-end card.
  - Clean the optical connectors on the card. Clean the connectors according to site practice or, if none exists, follow the procedure in the “Maintain the Node” chapter in the *Cisco ONS 15454 Procedure Guide*. If possible, do this for the OC-N card you are working on and the far-end card.
  - Ensure that the far-end transmitting card is not an ONS intermediate-range (IR) card when an ONS long-range (LR) card is appropriate.  
IR cards transmit a lower output power than LR cards.
  - Replace the far-end transmitting OC-N card to eliminate the possibility of a degrading transmitter on this OC-N card.

**Caution**

Removing a card that currently carries traffic on one or more ports can cause a traffic hit. To avoid this, perform an external switch if a switch has not already occurred. See the procedures in the [“2.9.2 Protection Switching, Lock Initiation, and Clearing”](#) section on page 2-262. For more information, refer to the “Maintain the Node” chapter in the *Cisco ONS 15454 Procedure Guide*.

- If the power level still falls below the specified range with the replacement fibers and replacement card, check for one of these three factors that attenuate the power level and affect link loss (LL):
  - Excessive fiber distance; single-mode fiber attenuates at approximately 0.5 dB/km.
  - Excessive number or fiber connectors; connectors take approximately 0.5 dB each.
  - Excessive number of fiber splices; splices take approximately 0.5 dB each.

**Note**

These are typical attenuation values. Refer to the specific product documentation for the actual values or use an optical time domain reflectometer (OTDR) to establish precise link loss and budget requirements.

- Step 5** If no power level shows on the fiber, the fiber is bad or the transmitter on the OC-N card failed.
- Check that the Tx and Rx fibers are not reversed. LOS and EOC alarms normally accompany reversed Tx and Rx fibers. Switching reversed Tx and Rx fibers clears the alarms and restores the signal.
  - Clean or replace the fiber patch cords. Clean the fiber according to site practice or, if none exists, follow the procedure in the “Maintain the Node” chapter in the *Cisco ONS 15454 Procedure Guide*. If possible, do this for the OC-N card you are working on and the far-end card.

- c. Retest the fiber power level.
- d. If the replacement fiber still shows no power, replace the OC-N card.

**Caution**

Removing a card that currently carries traffic on one or more ports can cause a traffic hit. To avoid this, perform an external switch if a switch has not already occurred. See the procedures in the “2.9.2 Protection Switching, Lock Initiation, and Clearing” section on page 2-262. For more information, refer to the “Maintain the Node” chapter in the *Cisco ONS 15454 Procedure Guide*.

**Step 6**

If the power level on the fiber is above the range specified for the card, ensure that an ONS LR card is not being used when an ONS IR card is appropriate.

LR cards transmit a higher output power than IR cards. When used with short runs of fiber, an LR transmitter is too powerful for the receiver on the receiving OC-N card.

Receiver overloads occur when maximum receiver power is exceeded.

**Tip**

To prevent overloading the receiver, use an attenuator on the fiber between the ONS OC-N card transmitter and the receiver. Place the attenuator on the receive transmitter of the ONS OC-N cards. Refer to the attenuator documentation for specific instructions.

**Tip**

Most fiber has text printed on only one of the two fiber strands. Use this to identify which fiber is connected to Tx and which fiber is connected to Rx.

### 1.12.2.1 Crimp Replacement LAN Cables

You can crimp your own LAN cables for use with the ONS 15454. Use a cross-over cable when connecting an ONS 15454 to a hub, LAN modem, or switch, and use a LAN cable when connecting an ONS 15454 to a router or workstation. Use Category-5 cable RJ-45 T-568B, Color Code (100 Mbps), and a crimping tool. [Figure 1-52](#) shows the wiring of an RJ-45 connector. [Figure 1-53](#) shows a LAN cable layout, and [Table 1-4](#) shows the cable pinouts. [Figure 1-54](#) shows a cross-over cable layout, and [Table 1-5](#) shows the cross-over pinouts.

**Figure 1-52 RJ-45 Pin Numbers**

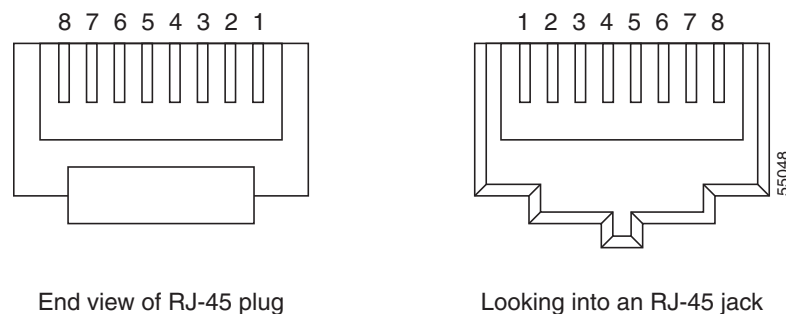

End view of RJ-45 plug

Looking into an RJ-45 jack

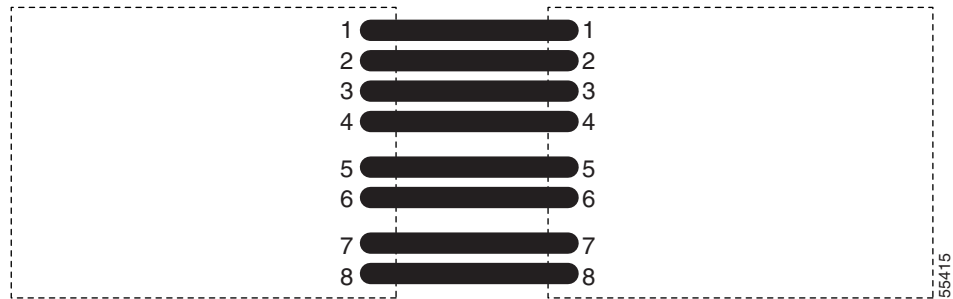
**Figure 1-53 LAN Cable Layout****Table 1-4 LAN Cable Pinout**

| Pin | Color        | Pair | Name            | Pin |
|-----|--------------|------|-----------------|-----|
| 1   | white/orange | 2    | Transmit Data + | 1   |
| 2   | orange       | 2    | Transmit Data – | 2   |
| 3   | white/green  | 3    | Receive Data +  | 3   |
| 4   | blue         | 1    | —               | 4   |
| 5   | white/blue   | 1    | —               | 5   |
| 6   | green        | 3    | Receive Data –  | 6   |
| 7   | white/brown  | 4    | —               | 7   |
| 8   | brown        | 4    | —               | 8   |

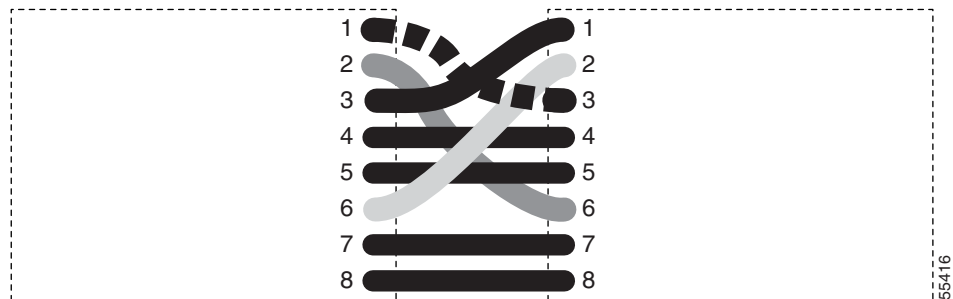
**Figure 1-54 Cross-Over Cable Layout****Table 1-5 Cross-Over Cable Pinout**

| Pin | Color        | Pair | Name            | Pin |
|-----|--------------|------|-----------------|-----|
| 1   | white/orange | 2    | Transmit Data + | 3   |
| 2   | orange       | 2    | Transmit Data – | 6   |
| 3   | white/green  | 3    | Receive Data +  | 1   |
| 4   | blue         | 1    | —               | 4   |
| 5   | white/blue   | 1    | —               | 5   |
| 6   | green        | 3    | Receive Data –  | 2   |

**Table 1-5** Cross-Over Cable Pinout (continued)

| Pin | Color       | Pair | Name | Pin |
|-----|-------------|------|------|-----|
| 7   | white/brown | 4    | —    | 7   |
| 8   | brown       | 4    | —    | 8   |

**Note**

Odd-numbered pins always connect to a white wire with a colored stripe.

### 1.12.2.2 Replace Faulty GBIC, SFP, or XFP Connectors

GBICs and Small Form-factor Pluggables (SFP or XFP) are hot-swappable and can be installed or removed while the card or shelf assembly is powered and running.

**Warning**

**Class 1 laser product.** Statement 1008

**Warning**

**Invisible laser radiation may be emitted from disconnected fibers or connectors. Do not stare into beams or view directly with optical instruments.** Statement 272

GBICs and SFPs/XFPs are input/output devices that plug into a Gigabit Ethernet card to link the port with the fiber-optic network. The type of GBIC or SFP determines the maximum distance that the Ethernet traffic can travel from the card to the next network device. For a description of GBICs and SFPs and their capabilities, refer to the *Cisco ONS 15454 Reference Manual*.

**Note**

GBICs and SFPs must be matched on either end by type: SX to SX, LX to LX, or ZX to ZX.

**Note**

All versions of G1K-4 cards support coarse wavelength division multiplexing (CWDM) GBICs.

GBICs are available in two different models. One GBIC model has two clips (one on each side of the GBIC) that secure the GBIC in the slot on the E1000-2-G, G-Series, or G1K-4 card. The other model has a locking handle. Both models are shown in [Figure 1-55](#).

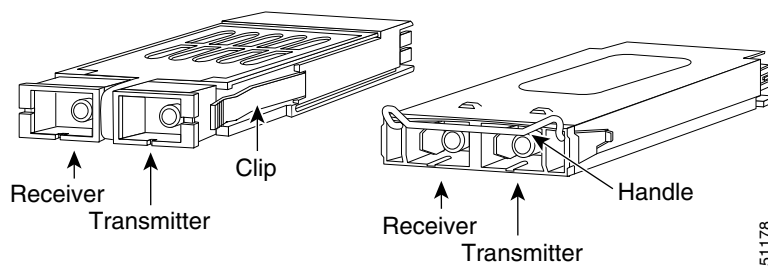
**Figure 1-55** GBICs

**Note**

GBICs are very similar in appearance. Check the GBIC label carefully before installing it.

## Remove GBIC, SFP, or XFP Connectors

**Warning**

**Invisible laser radiation may be emitted from disconnected fibers or connectors. Do not stare into beams or view directly with optical instruments.** Statement 272

- 
- Step 1** Disconnect the network fiber cable from the GBIC SC connector or XFP/SFP LC duplex connector.
- Step 2** Release the GBIC or SFP/XFP from the slot by simultaneously squeezing the two plastic tabs on each side.
- Step 3** Slide the GBIC or SFP/XFP out of the Gigabit Ethernet module slot. A flap closes over the GBIC or SFP slot to protect the connector on the Gigabit Ethernet card.
- 

## Install a GBIC or SFP/XFP Device

**Warning**

**Class 1 laser product.** Statement 1008

**Warning**

**Invisible laser radiation could be emitted from the end of the unterminated fiber cable or connector. Do not stare into the beam directly with optical instruments. Viewing the laser output with certain optical instruments (for example, eye loupes, magnifiers, and microscopes) within a distance of 100 mm could pose an eye hazard.** Statement 1056

**Note**

G-Series cards manufactured before August 2003 do not support DWDM GBICs. G1K-4 cards compatible with DWDM GBICs have a Common Language Equipment Identification (CLEI) code of WM5IRWPCAA.

**Note**

All versions of G1K-4 cards support coarse wavelength division multiplexing (CWDM) GBICs.

**Note**

GBICs, SFPs, and XFPs are hot-swappable and can therefore be installed/removed while the card/shelf assembly is powered and running.

- 
- Step 1** Remove the GBIC, SFP, or XFP from its protective packaging.
- Step 2** Check the label to verify that the GBIC, SFP, or XFP is the correct type for your network. For a list of GBICs and SFPs that are compatible with Ethernet cards, refer to the “Ethernet Cards” chapter in the *Cisco ONS 15454 Reference Manual*. For a list of GBICs that are compatible with the FC\_MR-4 card,



refer to the “Storage Access Networking Cards” chapter in the *Cisco ONS 15454 Reference Manual*. For a list of SFPs and XFPs that are compatible with each optical card, refer to the “Optical Cards” chapter in the *Cisco ONS 15454 Reference Manual*.



---

**Note** Before you install SFPs on the MRC-12 card, refer to the MRC-12 card information in the *Cisco ONS 15454 Reference Manual* for bandwidth restrictions based on the port where you install the SFP and the cross-connect card being used.

---

**Step 3** Verify the type of GBIC, SFP, or XFP you are using:

- If you are using a GBIC with clips, go to [Step 4](#).
- If you are using a GBIC with a handle, go to [Step 5](#).
- If you are using an SFP or XFP, go to [Step 6](#).

**Step 4** For GBICs with clips:

- a. Grip the sides of the GBIC with your thumb and forefinger and insert the GBIC into the slot on the card.



---

**Note** GBICs are keyed to prevent incorrect installation.

---

- b. Slide the GBIC through the flap that covers the opening until you hear a click. The click indicates the GBIC is locked into the slot.
- c. When you are ready to attach the network fiber-optic cable, remove the protective plug from the GBIC, save the plug for future use, then plug the fiber connector into the GBIC.

**Step 5** For GBICs with a handle:

- a. Remove the protective plug from the SC-type connector.
- b. Grip the sides of the GBIC with your thumb and forefinger and insert the GBIC into the slot on the card.
- c. Lock the GBIC into place by closing the handle down. The handle is in the correct closed position when it does not obstruct access to an SC-type connector.
- d. Slide the GBIC through the cover flap until you hear a click.  
The click indicates that the GBIC is locked into the slot.
- e. When you are ready to attach the network fiber-optic cable, remove the protective plug from the GBIC, save the plug for future use, then plug the fiber connector into the GBIC.

**Step 6** For SFPs and XFPs:

- a. Plug the LC duplex connector of the fiber into a Cisco-supported SFP or XFP.
  - b. If the new SFP or XFP has a latch, close the latch over the cable to secure it.
  - c. Plug the cabled SFP or XFP into the card port until it clicks.
- 

## 1.12.3 OC-N Card Transmit and Receive Levels

Each OC-N card has a transmit and receive connector on its faceplate. [Table 1-6](#) lists these levels.

**Table 1-6** *Optical Card Transmit and Receive Levels*

| Card                                                         | Transmit |         | Receive                 |         |
|--------------------------------------------------------------|----------|---------|-------------------------|---------|
|                                                              | Minimum  | Maximum | Minimum                 | Maximum |
| OC3 IR 4/STM1 SH 1310                                        | -15 dBm  | -8 dBm  | -28 dBm                 | -8 dBm  |
| OC3IR/STM1SH 1310-8                                          | -15 dBm  | -8 dBm  | -28 dBm                 | -8 dBm  |
| OC12 IR/STM4 SH 1310                                         | -15 dBm  | -8 dBm  | -28 dBm                 | -8 dBm  |
| OC12 LR/STM4 LH 1310                                         | -3 dBm   | +2 dBm  | -28 dBm                 | -8 dBm  |
| OC12 LR/STM4 LH 1550                                         | -3 dBm   | +2 dBm  | -28 dBm                 | -8 dBm  |
| OC12 IR/STM4 SH 1310-4                                       | -15 dBm  | -8 dBm  | -30 dBm                 | -8 dBm  |
| OC48 IR 1310                                                 | -5 dBm   | 0 dBm   | -18 dBm                 | 0 dBm   |
| OC48 LR 1550                                                 | -2 dBm   | +3 dBm  | -28 dBm                 | -8 dBm  |
| OC48 IR/STM16 SH AS 1310                                     | -5 dBm   | 0 dBm   | -18 dBm                 | 0 dBm   |
| OC48 LR/STM16 LH AS 1550                                     | -2 dBm   | +3 dBm  | -28 dBm                 | -8 dBm  |
| OC48 ELR/STM16 EH 100 GHz                                    | -2 dBm   | 0 dBm   | -27 dBm at<br>1E-12 BER | -9 dBm  |
| OC48 ELR/STM16 EH 200 GHz                                    | -2 dBm   | 0 dBm   | -28 dBm                 | -8 dBm  |
| OC192 SR/STM64 IO 1310                                       | -6 dBm   | -1 dBm  | -11 dBm                 | -1 dBm  |
| OC192 IR/STM64 SH 1550                                       | -1 dBm   | +2 dBm  | -14 dBm                 | -1 dBm  |
| OC192 LR/STM64 LH 1550                                       | +7 dBm   | +10 dBm | -19 dBm                 | -10 dBm |
| OC192 LR/STM64 LH ITU 15xx.xx                                | +3 dBm   | +6 dBm  | -22 dBm                 | -9 dBm  |
| 15454_MRC-12 (ONS-SI-2G-S1)                                  | -10 dBm  | -3 dBm  | -18 dBm                 | -3 dBm  |
| 15454_MRC-12 (ONS-SI-2G-I1)                                  | -5 dBm   | 0 dBm   | -18 dBm                 | 0 dBm   |
| 15454_MRC-12 (ONS-SI-2G-L1)                                  | -2 dBm   | 3 dBm   | -27 dBm                 | -9 dBm  |
| 15454_MRC-12 (ONS-SI-2G-L2)                                  | -2 dBm   | 3 dBm   | -28 dBm                 | -9 dBm  |
| 15454_MRC-12 (ONS-SC-2G-30.3<br>through ONS-SC-2G-60.6)      | 0 dBm    | 4 dBm   | -28 dBm                 | -9 dBm  |
| 15454_MRC-12 (ONS-SI-622-I1)                                 | -15 dBm  | -8 dBm  | -28 dBm                 | -8 dBm  |
| 15454_MRC-12 (ONS-SI-622-L1)                                 | -3 dBm   | 2 dBm   | -28 dBm                 | -8 dBm  |
| 15454_MRC-12 (ONS-SI-622-L2)                                 | -3 dBm   | 2 dBm   | -28 dBm                 | -8 dBm  |
| 15454_MRC-12<br>(ONS-SE-622-1470 through<br>ONS-SE-622-1610) | 0 dBm    | 5 dBm   | -28 dBm                 | -3 dBm  |
| 15454_MRC-12 (ONS-SI-155-I1)                                 | -15 dBm  | -8 dBm  | -30 dBm                 | -8 dBm  |
| 15454_MRC-12 (ONS-SI-155-L1)                                 | -5 dBm   | 0 dBm   | -34 dBm                 | -10 dBm |
| 15454_MRC-12 (ONS-SI-155-L2)                                 | -5 dBm   | 0 dBm   | -34 dBm                 | -10 dBm |
| 15454_MRC-12<br>(ONS_SE-155-1470 through<br>ONS-SE-155-1610) | 0 dBm    | 5 dBm   | -34 dBm                 | -3 dBm  |
| 15454_MRC_12<br>ONS-SI-155-I1-MM=                            | -9 dBm   | -14 dBm | -14 dBm                 | -5 dBm  |

Table 1-6 Optical Card Transmit and Receive Levels (continued)

| Card                                                     | Transmit |         | Receive                                       |                                                                                       |
|----------------------------------------------------------|----------|---------|-----------------------------------------------|---------------------------------------------------------------------------------------|
|                                                          | Minimum  | Maximum | Minimum                                       | Maximum                                                                               |
| 15454_MRC_12<br>ONS-SI-622-I1-MM=                        | -9 dBm   | -14 dBm | -14 dBm                                       | -5 dBm                                                                                |
| 15454_MRC_12<br>ONS-SC-Z3-1470 through<br>ONS-SC-Z3-1610 | 0 dBm    | 5 dBm   | -9 dBm                                        | —                                                                                     |
| 15454_MRC_12<br>ONS-SE-Z1=                               | -5 dBm   | 0 dBm   | -10 dBm<br>0 dBm<br>-18 dBm<br>0 dBm<br>0 dBm | -23 dBm (OC-3)<br>-23 dBm<br>(OC-12)<br>0 dBm (OC-48)<br>-21 dBm (FC)<br>-22 dBm (GE) |
| OC192SR1/STM64IO Short Reach<br>(ONS-XC-10G-S1)          | -6 dBm   | -1 dBm  | -11 dBm                                       | -1 dBm                                                                                |
| OC192/STM64 Any Reach<br>(ONS-XC-10G-S1)                 | -6 dBm   | -1 dBm  | -11 dBm                                       | -1 dBm                                                                                |
| OC192/STM64 Any Reach<br>(ONS-XC-10G-I2)                 | -1 dBm   | 2 dBm   | -14 dBm                                       | 2 dBm                                                                                 |
| OC192/STM64 Any Reach<br>(ONS-XC-10G-L2)                 | 0 dBm    | 4 dBm   | -24 dBm                                       | -7dBm                                                                                 |

## 1.13 Power Supply Problems

**Symptom** Loss of power or low voltage, resulting in a loss of traffic and causing the LCD clock to reset to the default date and time.

**Possible Cause** Loss of power or low voltage.

**Possible Cause** Improperly connected power supply.

**Recommended Action** The ONS 15454 requires a constant source of DC power to properly function. Input power is -48 VDC. Power requirements range from -42 VDC to -57 VDC. A newly installed ONS 15454 that is not properly connected to its power supply does not operate. Power problems can be confined to a specific ONS 15454 or affect several pieces of equipment on the site. A loss of power or low voltage can result in a loss of traffic and causes the LCD clock on the ONS 15454 to default to January 1, 1970, 00:04:15. To reset the clock, in node view click the

**Provisioning > General > General** tabs and change the Date and Time fields. Complete the [“Isolate the Cause of Power Supply Problems” procedure on page 1-148](#).



**Warning**

**Only trained and qualified personnel should be allowed to install, replace, or service this equipment.**  
Statement 1030

**Warning**

---

**During this procedure, wear grounding wrist straps to avoid ESD damage to the card. Do not directly touch the backplane with your hand or any metal tool, or you could shock yourself.** Statement 94

---

**Caution**

---

Operations that interrupt power supply or short the power connections to the ONS 15454 are service-affecting.

---

## Isolate the Cause of Power Supply Problems

- 
- Step 1** If a single ONS 15454 show signs of fluctuating power or power loss:
- a. Verify that the –48 VDC #8 power terminals are properly connected to a fuse panel. These power terminals are located on the lower section of the backplane EIA under the clear plastic cover.
  - b. Verify that the power cable is #12 or #14 AWG and in good condition.
  - c. Verify that the power cable connections are properly crimped. Stranded #12 or #14 AWG does not always crimp properly with Staycon type connectors.
  - d. Verify that 20-A fuses are used in the fuse panel.
  - e. Verify that the fuses are not blown.
  - f. Verify that a rack-ground cable attaches to the frame-ground terminal (FGND) on the right side of the ONS 15454 EIA. Connect this cable to the ground terminal according to local site practice.
  - g. Verify that the DC power source has enough capacity to carry the power load.
  - h. If the DC power source is battery-based:
    - Check that the output power is high enough. Power requirements range from –42 VDC to –57 VDC.
    - Check the age of the batteries. Battery performance decreases with age.
    - Check for opens and shorts in batteries, which might affect power output.
    - If brownouts occur, the power load and fuses might be too high for the battery plant.
- Step 2** If multiple pieces of site equipment show signs of fluctuating power or power loss:
- a. Check the uninterruptible power supply (UPS) or rectifiers that supply the equipment. Refer to the UPS manufacturer’s documentation for specific instructions.
  - b. Check for excessive power drains caused by other equipment, such as generators.
  - c. Check for excessive power demand on backup power systems or batteries when alternate power sources are used.
-

## 1.13.1 Power Consumption for Node and Cards

**Symptom** You are unable to power up a node or the cards in a node.

**Possible Cause** Improper power supply.

**Recommended Action** Refer to power information in the “Hardware Specifications” appendix in the *Cisco ONS 15454 Reference Manual*.





## Alarm Troubleshooting

---



### Note

The terms "Unidirectional Path Switched Ring" and "UPSR" may appear in Cisco literature. These terms do not refer to using Cisco ONS 15xxx products in a unidirectional path switched ring configuration. Rather, these terms, as well as "Path Protected Mesh Network" and "PPMN," refer generally to Cisco's path protection feature, which may be used in any topological network configuration. Cisco does not recommend using its path protection feature in any particular topological network configuration.

---

This chapter gives a description, severity, and troubleshooting procedure for each commonly encountered Cisco ONS 15454 alarm and condition. Tables 2-1 through 2-5 provide lists of ONS 15454 alarms organized by severity. Table 2-6 on page 2-11 provides a list of alarms organized alphabetically. Table 2-7 gives definitions of all ONS 15454 alarm logical objects, which are the basis of the alarm profile list in Table 2-8 on page 2-23. For a comprehensive list of all conditions and instructions for using TL1 commands, refer to the *Cisco ONS SONET TL1 Command Guide*.

An alarm's troubleshooting procedure applies to both the Cisco Transport Controller (CTC) and TL1 version of that alarm. If the troubleshooting procedure does not clear the alarm, log into the Technical Support Website at <http://www.cisco.com/techsupport> for more information or call the Cisco Technical Assistance Center 1 800 553-2447.

For more information about alarm profiles, refer to the "Manage Alarms" chapter in the *Cisco ONS 15454 Procedure Guide*.

## 2.1 Alarm Indexes by Default Severity

The following tables group alarms and conditions by their default severities in the ONS 15454 system. These severities are the same whether they are reported in the CTC Alarms window severity (SEV) column or in TL1.



### Note

The CTC default alarm profile contains some alarms or conditions that are not currently implemented but are reserved for future use.

---

**Note**

The CTC default alarm profile in some cases contains two severities for one alarm (for example, MJ/MN). The ONS 15454 platform default severity comes first (in this example, MJ), but the alarm can be demoted to the second severity in the presence of a higher-ranking alarm. This is in accordance with Telcordia GR-474.

## 2.1.1 Critical Alarms (CR)

Table 2-1 alphabetically lists ONS 15454 Critical (CR) alarms.

**Table 2-1** ONS 15454 Critical Alarm List

|                           |                |                       |
|---------------------------|----------------|-----------------------|
| —                         | LOA (VCG)      | MFGMEM (PPM)          |
| —                         | LOF (DS3)      | OPWR-HFAIL (AOTS)     |
| AUTOLROFF (OCN)           | LOF (EC1)      | OPWR-HFAIL (OCH)      |
| AWG-FAIL (OTS)            | LOF (OCN)      | OPWR-HFAIL (OMS)      |
| AWG-OVERTEMP (OTS)        | LOF (STSTRM)   | OPWR-HFAIL (OTS)      |
| BKUPMEMP (EQPT)           | LOF (TRUNK)    | OPWR-LFAIL (AOTS)     |
| COMIOXC (EQPT)            | LOM (STSMON)   | OPWR-LFAIL (OCH-TERM) |
| CONTBUS-DISABLED (EQPT)   | LOM (STSTRM)   | OPWR-LFAIL (OCH)      |
| CTNEQPT-PBPROT (EQPT)     | LOM (TRUNK)    | OPWR-LFAIL (OMS)      |
| CTNEQPT-PBWORK (EQPT)     | LOP-P (STSMON) | OPWR-LFAIL (OTS)      |
| ENCAP-MISMATCH-P (STSTRM) | LOP-P (STSTRM) | OTUK-LOF (TRUNK)      |
| EQPT (AICI-AEP)           | LOS (2R)       | OTUK-TIM (TRUNK)      |
| EQPT (AICI-AIE)           | LOS (DS3)      | PLM-P (STSMON)        |
| EQPT (EQPT)               | LOS (EC1)      | PLM-P (STSTRM)        |
| EQPT (PPM)                | LOS (ESCON)    | PORT-FAIL (OCH)       |
| EQPT-DIAG (EQPT)          | LOS (ISC)      | SQM (STSTRM)          |
| EQPT-MISS (FAN)           | LOS (OCN)      | SWMTXMOD-PROT (EQPT)  |
| FAN (FAN)                 | LOS (OTS)      | SWMTXMOD-WORK (EQPT)  |
| GAIN-HFAIL (AOTS)         | LOS (TRUNK)    | TIM (OCN)             |
| GAIN-LFAIL (AOTS)         | LOS-P (OCH)    | TIM (TRUNK)           |
| GE-OOSYNC (FC)            | LOS-P (OMS)    | TIM-P (STSTRM)        |
| GE-OOSYNC (GE)            | LOS-P (OTS)    | TIM-S (EC1)           |
| GE-OOSYNC (ISC)           | LOS-P (TRUNK)  | TIM-S (OCN)           |
| GE-OOSYNC (TRUNK)         | MEA (AIP)      | UNEQ-P (STSMON)       |
| HITEMP (NE)               | MEA (BIC)      | UNEQ-P (STSTRM)       |
| I-HITEMP (NE)             | MEA (EQPT)     | VOA-HFAIL (AOTS)      |
| ILK-FAIL (TRUNK)          | MEA (FAN)      | VOA-HFAIL (OCH)       |
| IMPROPRMVL (EQPT)         | MEA (PPM)      | VOA-HFAIL (OMS)       |



**Table 2-1** ONS 15454 Critical Alarm List (continued)

|                         |                   |                  |
|-------------------------|-------------------|------------------|
| IMPROPRMVL (PPM)        | MFGMEM (AICI-AEP) | VOA-HFAIL (OTS)  |
| LINK-KEEPALIVE (ML1000) | MFGMEM (AICI-AIE) | VOA-LFAIL (AOTS) |
| LINK-KEEPALIVE (ML100T) | MFGMEM (AIP)      | VOA-LFAIL (OCH)  |
| LINK-KEEPALIVE (MLFX)   | MFGMEM (BPLANE)   | VOA-LFAIL (OMS)  |
| LINK-KEEPALIVE (MLMR)   | MFGMEM (FAN)      | VOA-LFAIL (OTS)  |

## 2.1.2 Major Alarms (MJ)

Table 2-2 alphabetically lists ONS 15454 Major (MJ) alarms.

**Table 2-2** ONS 15454 Major Alarm List

|                        |                           |                              |
|------------------------|---------------------------|------------------------------|
| APSCM (OCN)            | GFP-DE-MISMATCH (GFP-FAC) | RCVR-MISS (DS1)              |
| APSCNMIS (OCN)         | GFP-EX-MISMATCH (CE1000)  | RCVR-MISS (E1)               |
| AUTONEG-RFI (ML1000)   | GFP-EX-MISMATCH (FCMR)    | RSV-RT-EXCD-RINGLET0 (RPRIF) |
| BAT-FAIL (PWR)         | GFP-EX-MISMATCH (GFP-FAC) | RSV-RT-EXCD-RINGLET1 (RPRIF) |
| BLSROSYNC (OCN)        | GFP-LFD (CE1000)          | RING-ID-MIS (OCN)            |
| BLSR-SW-VER-MISM (OCN) | GFP-LFD (CE100T)          | RING-ID-MIS (OSC-RING)       |
| CARLOSS (CE1000)       | GFP-LFD (CEMR)            | RING-MISMATCH (OCN)          |
| CARLOSS (CE100T)       | GFP-LFD (FCMR)            | RPR-PEER-MISS (RPRIF)        |
| CARLOSS (CEMR)         | GFP-LFD (GFP-FAC)         | RPR-PROT-CONFIG-MISM (RPRIF) |
| CARLOSS (E1000F)       | GFP-LFD (ML1000)          | RPR-RI-FAIL (RPRIF)          |
| CARLOSS (E100T)        | GFP-LFD (ML100T)          | RPR-SPAN-MISMATCH (ML1000)   |
| CARLOSS (EQPT)         | GFP-LFD (MLFX)            | RPR-SPAN-MISMATCH (ML100T)   |
| CARLOSS (FC)           | GFP-LFD (MLMR)            | RPR-SPAN-MISMATCH (MLFX)     |
| CARLOSS (G1000)        | GFP-NO-BUFFERS (FCMR)     | RPR-SPAN-MISMATCH (MLMR)     |
| CARLOSS (GE)           | GFP-NO-BUFFERS (GFP-FAC)  | SHELF-COMM-FAIL (SHELF)      |
| CARLOSS (ISC)          | GFP-UP-MISMATCH (CE1000)  | SIGLOSS (ESCON)              |
| CARLOSS (ML1000)       | GFP-UP-MISMATCH (CE100T)  | SIGLOSS (FC)                 |
| CARLOSS (ML100T)       | GFP-UP-MISMATCH (CEMR)    | SIGLOSS (FCMR)               |
| CARLOSS (MLFX)         | GFP-UP-MISMATCH (FCMR)    | SIGLOSS (GE)                 |
| CARLOSS (MLMR)         | GFP-UP-MISMATCH (GFP-FAC) | SIGLOSS (ISC)                |
| CARLOSS (TRUNK)        | GFP-UP-MISMATCH (ML1000)  | SIGLOSS (TRUNK)              |
| DATA-CRC (CE100T)      | GFP-UP-MISMATCH (ML100T)  | SQM (VT-TERM)                |
| DATA-CRC (ML1000)      | GFP-UP-MISMATCH (MLFX)    | SYNCLOSS (FC)                |
| DATA-CRC (ML100T)      | GFP-UP-MISMATCH (MLMR)    | SYNCLOSS (FCMR)              |
| DATA-CRC (MLFX)        | HIBATVG (PWR)             | SYNCLOSS (GE)                |
| DBOSYNC (NE)           | INVMACADR (AIP)           | SYNCLOSS (ISC)               |

**Table 2-2** ONS 15454 Major Alarm List (continued)

|                          |                        |                      |
|--------------------------|------------------------|----------------------|
| DSP-COMM-FAIL (TRUNK)    | LASERBIAS-FAIL (AOTS)  | SYNCLOSS (TRUNK)     |
| DSP-FAIL (TRUNK)         | LOF (DS1)              | SYNCPRI (NE-SREF)    |
| DUP-SHELF-ID (SHELF)     | LOF (E1)               | SYSBOOT (NE)         |
| EHIBATVG (PWR)           | LOM (VT-TERM)          | TIM-V (VT-MON)       |
| ELWBATVG (PWR)           | LOP-V (VT-MON)         | TIM-V (VT-TERM)      |
| E-W-MISMATCH (OCN)       | LOP-V (VT-TERM)        | TPTFAIL (CE1000)     |
| EXTRA-TRAF-PREEMPT (OCN) | LOS (DS1)              | TPTFAIL (CE100T)     |
| FC-DE-NES (FC)           | LOS (E1)               | TPTFAIL (CEMR)       |
| FC-DE-NES (FCMR)         | LWBATVG (PWR)          | TPTFAIL (FCMR)       |
| FC-DE-NES (TRUNK)        | MAX-STATIONS (RPRIF)   | TPTFAIL (G1000)      |
| FC-NO-CREDITS (FC)       | MEA (SHELF)            | TPTFAIL (ML1000)     |
| FC-NO-CREDITS (FCMR)     | MEM-GONE (EQPT)        | TPTFAIL (ML100T)     |
| FC-NO-CREDITS (TRUNK)    | ODUK-TIM-PM (TRUNK)    | TPTFAIL (MLFX)       |
| FEC-MISM (TRUNK)         | OUT-OF-SYNC (FC)       | TPTFAIL (MLMR)       |
| GFP-CSF (CE1000)         | OUT-OF-SYNC (GE)       | TRMT (DS1)           |
| GFP-CSF (CE100T)         | OUT-OF-SYNC (TRUNK)    | TRMT (E1)            |
| GFP-CSF (CEMR)           | PEER-NORESPONSE (EQPT) | TRMT-MISS (DS1)      |
| GFP-CSF (FCMR)           | PLM-V (VT-MON)         | TRMT-MISS (E1)       |
| GFP-CSF (GFP-FAC)        | PLM-V (VT-TERM)        | UNEQ-V (VT-MON)      |
| GFP-CSF (ML1000)         | PORT-MISMATCH (CEMR)   | UNEQ-V (VT-TERM)     |
| GFP-CSF (ML100T)         | PORT-MISMATCH (MLMR)   | UT-COMM-FAIL (TRUNK) |
| GFP-CSF (MLFX)           | PRC-DUPID (OCN)        | UT-FAIL (TRUNK)      |
| GFP-CSF (MLMR)           | PROV-MISMATCH (TRUNK)  | WVL-MISMATCH (TRUNK) |
| GFP-DE-MISMATCH (FCMR)   | PTIM (TRUNK)           | —                    |

## 2.1.3 Minor Alarms (MN)

Table 2-3 alphabetically lists ONS 15454 Minor (MN) alarms.

**Table 2-3** ONS 15454 Minor Alarm List

|                         |                      |                    |
|-------------------------|----------------------|--------------------|
| —                       | HI-LASERBIAS (TRUNK) | LO-TXPOWER (2R)    |
| —                       | HI-LASERTEMP (EQPT)  | LO-TXPOWER (EQPT)  |
| APC-CORR-SKIPPED (AOTS) | HI-LASERTEMP (OCN)   | LO-TXPOWER (ESCON) |
| APC-CORR-SKIPPED (OCH)  | HI-LASERTEMP (PPM)   | LO-TXPOWER (FC)    |
| APC-CORR-SKIPPED (OMS)  | HI-RXPOWER (2R)      | LO-TXPOWER (GE)    |
| APC-CORR-SKIPPED (OTS)  | HI-RXPOWER (ESCON)   | LO-TXPOWER (ISC)   |
| APC-OUT-OF-RANGE (AOTS) | HI-RXPOWER (FC)      | LO-TXPOWER (OCN)   |

Table 2-3 ONS 15454 Minor Alarm List (continued)

|                             |                           |                            |
|-----------------------------|---------------------------|----------------------------|
| APC-OUT-OF-RANGE (OCH)      | HI-RXPOWER (GE)           | LO-TXPOWER (PPM)           |
| APC-OUT-OF-RANGE (OMS)      | HI-RXPOWER (ISC)          | LO-TXPOWER (TRUNK)         |
| APC-OUT-OF-RANGE (OTS)      | HI-RXPOWER (OCN)          | MEM-LOW (EQPT)             |
| APSB (OCN)                  | HI-RXPOWER (TRUNK)        | NON-CISCO-PPM (PPM)        |
| APSCDFLTK (OCN)             | HITEMP (EQPT)             | OPWR-HDEG (AOTS)           |
| APSC-IMP (OCN)              | HI-TXPOWER (2R)           | OPWR-HDEG (OCH-TERM)       |
| APSCINCON (OCN)             | HI-TXPOWER (EQPT)         | OPWR-HDEG (OCH)            |
| APSIMP (OCN)                | HI-TXPOWER (ESCON)        | OPWR-HDEG (OMS)            |
| APS-INV-PRIM (OCN)          | HI-TXPOWER (FC)           | OPWR-HDEG (OTS)            |
| APSM (OCN)                  | HI-TXPOWER (GE)           | OPWR-LDEG (AOTS)           |
| APS-PRIM-SEC-MISM (OCN)     | HI-TXPOWER (ISC)          | OPWR-LDEG (OCH-TERM)       |
| AUTORESET (EQPT)            | HI-TXPOWER (OCN)          | OPWR-LDEG (OCH)            |
| AWG-DEG (OTS)               | HI-TXPOWER (PPM)          | OPWR-LDEG (OMS)            |
| BPV (BITS)                  | HI-TXPOWER (TRUNK)        | OPWR-LDEG (OTS)            |
| CASETEMP-DEG (AOTS)         | ISIS-ADJ-FAIL (OCN)       | OTUK-IAE (TRUNK)           |
| COMM-FAIL (EQPT)            | ISIS-ADJ-FAIL (TRUNK)     | PROTNA (EQPT)              |
| CONTBUS-A-18 (EQPT)         | KBYTE-APS-CHAN-FAIL (OCN) | PROV-MISMATCH (PPM)        |
| CONTBUS-B-18 (EQPT)         | LASERBIAS-DEG (AOTS)      | PWR-FAIL-A (EQPT)          |
| CONTBUS-IO-A (EQPT)         | LASERBIAS-DEG (OTS)       | PWR-FAIL-B (EQPT)          |
| CONTBUS-IO-B (EQPT)         | LASEREOL (OCN)            | PWR-FAIL-RET-A (EQPT)      |
| DATAFLT (NE)                | LASERTEMP-DEG (AOTS)      | PWR-FAIL-RET-B (EQPT)      |
| DCU-LOSS-FAIL (OTS)         | LMP-FAIL (CTRL)           | ROUTE-OVERFLOW (NSA)       |
| DUP-IPADDR (NE)             | LMP-FAIL (GE)             | SFTWDOWN (EQPT)            |
| DUP-NODENAME (NE)           | LMP-FAIL (OCN)            | SH-IL-VAR-DEG-HIGH (OTS)   |
| EOC (OCN)                   | LMP-FAIL (TLINK)          | SH-IL-VAR-DEG-LOW (OTS)    |
| EOC (TRUNK)                 | LMP-SD (GE)               | SNTP-HOST (NE)             |
| EOC-L (OCN)                 | LMP-SD (OCN)              | SPANLEN-OUT-OF-RANGE (OTS) |
| EOC-L (TRUNK)               | LMP-SF (GE)               | SSM-FAIL (BITS)            |
| ERROR-CONFIG (EQPT)         | LMP-SF (OCN)              | SSM-FAIL (DS1)             |
| EXCCOL (EQPT)               | LOF (BITS)                | SSM-FAIL (E1)              |
| EXT (ENVALRM)               | LO-LASERBIAS (EQPT)       | SSM-FAIL (OCN)             |
| FAPS-CONFIG-MISMATCH (EQPT) | LO-LASERBIAS (OCN)        | SSM-FAIL (TRUNK)           |
| FEPRLF (OCN)                | LO-LASERBIAS (PPM)        | SYNCPRI (EXT-SREF)         |
| FE-SDPRLF (OCN)             | LO-LASERTEMP (EQPT)       | SYNCSEC (EXT-SREF)         |
| FIBERTEMP-DEG (AOTS)        | LO-LASERTEMP (OCN)        | SYNCSEC (NE-SREF)          |
| FP-LINK-LOSS (EQPT)         | LO-LASERTEMP (PPM)        | SYNCTHIRD (EXT-SREF)       |
| GAIN-HDEG (AOTS)            | LO-RXPOWER (2R)           | SYNCTHIRD (NE-SREF)        |

**Table 2-3** ONS 15454 Minor Alarm List (continued)

|                      |                    |                  |
|----------------------|--------------------|------------------|
| GAIN-LDEG (AOTS)     | LO-RXPOWER (ESCON) | TIM-MON (OCN)    |
| GCC-EOC (TRUNK)      | LO-RXPOWER (FC)    | TIM-MON (TRUNK)  |
| HELLO (OCN)          | LO-RXPOWER (GE)    | TIM-P (STSMON)   |
| HELLO (TRUNK)        | LO-RXPOWER (ISC)   | UNQUAL-PPM (PPM) |
| HI-LASERBIAS (2R)    | LO-RXPOWER (OCN)   | VOA-HDEG (AOTS)  |
| HI-LASERBIAS (EQPT)  | LO-RXPOWER (TRUNK) | VOA-HDEG (OCH)   |
| HI-LASERBIAS (ESCON) | LOS (BITS)         | VOA-HDEG (OMS)   |
| HI-LASERBIAS (FC)    | LOS (FUDC)         | VOA-HDEG (OTS)   |
| HI-LASERBIAS (GE)    | LOS (MSUDC)        | VOA-LDEG (AOTS)  |
| HI-LASERBIAS (ISC)   | LOS-O (OCH)        | VOA-LDEG (OCH)   |
| HI-LASERBIAS (OCN)   | LOS-O (OMS)        | VOA-LDEG (OMS)   |
| HI-LASERBIAS (PPM)   | LOS-O (OTS)        | VOA-LDEG (OTS)   |

## 2.1.4 NA Conditions

Table 2-4 alphabetically lists ONS 15454 Not Alarmed (NA) conditions.

**Table 2-4** ONS 15454 NA Conditions List

|                      |                          |                |
|----------------------|--------------------------|----------------|
| ALS (2R)             | FRCDSTWOPRI (EXT-SREF)   | SD (DS3)       |
| ALS (AOTS)           | FRCDSTWOPRI (NE-SREF)    | SD (TRUNK)     |
| ALS (ESCON)          | FRCDSTWTOSEC (EXT-SREF)  | SD-L (EC1)     |
| ALS (FC)             | FRCDSTWTOSEC (NE-SREF)   | SD-L (OCN)     |
| ALS (GE)             | FRCDSTWTOHIRD (EXT-SREF) | SD-L (TRUNK)   |
| ALS (ISC)            | FRCDSTWTOHIRD (NE-SREF)  | SD-P (STSMON)  |
| ALS (OCN)            | FRNGSYNC (NE-SREF)       | SD-P (STSTRM)  |
| ALS (TRUNK)          | FSTSYNC (NE-SREF)        | SD-V (VT-MON)  |
| ALS-DISABLED (EQPT)  | FTA-MISMATCH (EQPT)      | SD-V (VT-TERM) |
| AMPLI-INIT (AOTS)    | FULLPASSTHR-BI (OCN)     | SF (DS1)       |
| APC-DISABLED (AOTS)  | HI-CCVOLT (BITS)         | SF (DS3)       |
| APC-DISABLED (EQPT)  | HLDOVRSYNC (NE-SREF)     | SF (TRUNK)     |
| APC-DISABLED (NE)    | IDLE (DS1)               | SF-L (EC1)     |
| APC-DISABLED (OCH)   | INC-ISD (DS3)            | SF-L (OCN)     |
| APC-DISABLED (OMS)   | INHSWPR (EQPT)           | SF-L (TRUNK)   |
| APC-DISABLED (OTS)   | INHSSWWKG (EQPT)         | SF-P (STSMON)  |
| APC-DISABLED (SHELF) | INTRUSION-PSWD (NE)      | SF-P (STSTRM)  |
| APC-DISABLED (NE)    | IOSCFGCOPY (EQPT)        | SF-V (VT-MON)  |
| APC-END (NE)         | KB-PASSTHR (OCN)         | SF-V (VT-TERM) |

Table 2-4 ONS 15454 NA Conditions List (continued)

|                       |                           |                         |
|-----------------------|---------------------------|-------------------------|
| APC-WRONG-GAIN (AOTS) | LAN-POL-REV (NE)          | SHUTTER-OPEN (OTS)      |
| APS-PRIM-FAC (OCN)    | LASER-APR (AOTS)          | SPAN-NOT-MEASURED (OTS) |
| AS-CMD (2R)           | LCAS-CRC (STSTRM)         | SPAN-SW-EAST (OCN)      |
| AS-CMD (AOTS)         | LCAS-CRC (VT-TERM)        | SPAN-SW-WEST (OCN)      |
| AS-CMD (BPLANE)       | LCAS-RX-DNU (STSTRM)      | SQUELCH (OCN)           |
| AS-CMD (CE1000)       | LCAS-RX-DNU (VT-TERM)     | SQUELCHED (2R)          |
| AS-CMD (CE100T)       | LCAS-RX-FAIL (STSTRM)     | SQUELCHED (ESCON)       |
| AS-CMD (CEMR)         | LCAS-RX-FAIL (VT-TERM)    | SQUELCHED (FC)          |
| AS-CMD (DS1)          | LCAS-RX-GRP-ERR (STSTRM)  | SQUELCHED (GE)          |
| AS-CMD (DS3)          | LCAS-RX-GRP-ERR (VT-TERM) | SQUELCHED (ISC)         |
| AS-CMD (E1000F)       | LCAS-TX-ADD (STSTRM)      | SQUELCHED (OCN)         |
| AS-CMD (E100T)        | LCAS-TX-ADD (VT-TERM)     | SQUELCHED (TRUNK)       |
| AS-CMD (E1)           | LCAS-TX-DNU (STSTRM)      | SSM-DUS (BITS)          |
| AS-CMD (EC1)          | LCAS-TX-DNU (VT-TERM)     | SSM-DUS (DS1)           |
| AS-CMD (EQPT)         | LKOUTPR-S (OCN)           | SSM-DUS (E1)            |
| AS-CMD (ESCON)        | LMP-UNALLOC (GE)          | SSM-DUS (OCN)           |
| AS-CMD (FC)           | LMP-UNALLOC (OCN)         | SSM-DUS (TRUNK)         |
| AS-CMD (FCMR)         | LOCKOUT-REQ (2R)          | SSM-LNC (BITS)          |
| AS-CMD (G1000)        | LOCKOUT-REQ (EQPT)        | SSM-LNC (NE-SREF)       |
| AS-CMD (GE)           | LOCKOUT-REQ (ESCON)       | SSM-LNC (OCN)           |
| AS-CMD (GFP-FAC)      | LOCKOUT-REQ (FC)          | SSM-LNC (TRUNK)         |
| AS-CMD (ISC)          | LOCKOUT-REQ (GE)          | SSM-OFF (BITS)          |
| AS-CMD (ML1000)       | LOCKOUT-REQ (ISC)         | SSM-OFF (DS1)           |
| AS-CMD (ML100T)       | LOCKOUT-REQ (OCN)         | SSM-OFF (E1)            |
| AS-CMD (MLFX)         | LOCKOUT-REQ (STSMON)      | SSM-OFF (OCN)           |
| AS-CMD (MLMR)         | LOCKOUT-REQ (TRUNK)       | SSM-OFF (TRUNK)         |
| AS-CMD (NE)           | LOCKOUT-REQ (VT-MON)      | SSM-PRC (BITS)          |
| AS-CMD (OCH)          | LPBKCRS (STSMON)          | SSM-PRC (NE-SREF)       |
| AS-CMD (OCN)          | LPBKCRS (STSTRM)          | SSM-PRC (OCN)           |
| AS-CMD (OMS)          | LPBKDS1FE-CMD (DS1)       | SSM-PRC (TRUNK)         |
| AS-CMD (OTS)          | LPBKDS3FEAC (DS3)         | SSM-PRS (BITS)          |
| AS-CMD (PPM)          | LPBKDS3FEAC-CMD (DS3)     | SSM-PRS (DS1)           |
| AS-CMD (PWR)          | LPBKFACILITY (CE1000)     | SSM-PRS (E1)            |
| AS-CMD (SHELF)        | LPBKFACILITY (CE100T)     | SSM-PRS (NE-SREF)       |
| AS-CMD (TRUNK)        | LPBKFACILITY (CEMR)       | SSM-PRS (OCN)           |
| AS-MT (2R)            | LPBKFACILITY (DS1)        | SSM-PRS (TRUNK)         |
| AS-MT (AOTS)          | LPBKFACILITY (DS3)        | SSM-RES (BITS)          |

Table 2-4 ONS 15454 NA Conditions List (continued)

|                       |                       |                      |
|-----------------------|-----------------------|----------------------|
| AS-MT (CE1000)        | LPBKFACILITY (E1)     | SSM-RES (DS1)        |
| AS-MT (CE100T)        | LPBKFACILITY (EC1)    | SSM-RES (E1)         |
| AS-MT (CEMR)          | LPBKFACILITY (ESCON)  | SSM-RES (NE-SREF)    |
| AS-MT (DS1)           | LPBKFACILITY (FC)     | SSM-RES (OCN)        |
| AS-MT (DS3)           | LPBKFACILITY (FCMR)   | SSM-RES (TRUNK)      |
| AS-MT (E1)            | LPBKFACILITY (G1000)  | SSM-SDH-TN (BITS)    |
| AS-MT (EC1)           | LPBKFACILITY (GE)     | SSM-SDH-TN (NE-SREF) |
| AS-MT (EQPT)          | LPBKFACILITY (ISC)    | SSM-SDH-TN (OCN)     |
| AS-MT (ESCON)         | LPBKFACILITY (MLMR)   | SSM-SDH-TN (TRUNK)   |
| AS-MT (FC)            | LPBKFACILITY (OCN)    | SSM-SETS (BITS)      |
| AS-MT (FCMR)          | LPBKFACILITY (TRUNK)  | SSM-SETS (NE-SREF)   |
| AS-MT (G1000)         | LPBKTERMINAL (CE1000) | SSM-SETS (OCN)       |
| AS-MT (GE)            | LPBKTERMINAL (CE100T) | SSM-SETS (TRUNK)     |
| AS-MT (GFP-FAC)       | LPBKTERMINAL (CEMR)   | SSM-SMC (BITS)       |
| AS-MT (ISC)           | LPBKTERMINAL (DS1)    | SSM-SMC (DS1)        |
| AS-MT (ML1000)        | LPBKTERMINAL (DS3)    | SSM-SMC (E1)         |
| AS-MT (ML100T)        | LPBKTERMINAL (E1)     | SSM-SMC (NE-SREF)    |
| AS-MT (MLFX)          | LPBKTERMINAL (EC1)    | SSM-SMC (OCN)        |
| AS-MT (MLMR)          | LPBKTERMINAL (ESCON)  | SSM-SMC (TRUNK)      |
| AS-MT (OCH)           | LPBKTERMINAL (FC)     | SSM-ST2 (BITS)       |
| AS-MT (OCN)           | LPBKTERMINAL (FCMR)   | SSM-ST2 (DS1)        |
| AS-MT (OMS)           | LPBKTERMINAL (G1000)  | SSM-ST2 (E1)         |
| AS-MT (OTS)           | LPBKTERMINAL (GE)     | SSM-ST2 (NE-SREF)    |
| AS-MT (PPM)           | LPBKTERMINAL (ISC)    | SSM-ST2 (OCN)        |
| AS-MT (SHELF)         | LPBKTERMINAL (MLMR)   | SSM-ST2 (TRUNK)      |
| AS-MT (TRUNK)         | LPBKTERMINAL (OCN)    | SSM-ST3 (BITS)       |
| AS-MT-OOG (STSTRM)    | LPBKTERMINAL (TRUNK)  | SSM-ST3 (DS1)        |
| AS-MT-OOG (VT-TERM)   | MAN-REQ (EQPT)        | SSM-ST3 (E1)         |
| AUD-LOG-LOSS (NE)     | MAN-REQ (ML1000)      | SSM-ST3 (NE-SREF)    |
| AUD-LOG-LOW (NE)      | MAN-REQ (ML100T)      | SSM-ST3 (OCN)        |
| AUTOSW-LOP (STSMON)   | MAN-REQ (MLFX)        | SSM-ST3 (TRUNK)      |
| AUTOSW-LOP (VT-MON)   | MAN-REQ (MLMR)        | SSM-ST3E (BITS)      |
| AUTOSW-PDI (STSMON)   | MAN-REQ (STSMON)      | SSM-ST3E (DS1)       |
| AUTOSW-PDI (VT-MON)   | MAN-REQ (VT-MON)      | SSM-ST3E (E1)        |
| AUTOSW-SDBER (STSMON) | MANRESET (EQPT)       | SSM-ST3E (NE-SREF)   |
| AUTOSW-SDBER (VT-MON) | MANSWTOINT (NE-SREF)  | SSM-ST3E (OCN)       |
| AUTOSW-SFBER (STSMON) | MANSWTOPRI (EXT-SREF) | SSM-ST3E (TRUNK)     |

Table 2-4 ONS 15454 NA Conditions List (continued)

|                           |                          |                           |
|---------------------------|--------------------------|---------------------------|
| AUTOSW-SFBER (VT-MON)     | MANSWTOPRI (NE-SREF)     | SSM-ST4 (BITS)            |
| AUTOSW-UNEQ (STSMON)      | MANSWTOSEC (EXT-SREF)    | SSM-ST4 (DS1)             |
| AUTOSW-UNEQ (VT-MON)      | MANSWTOSEC (NE-SREF)     | SSM-ST4 (E1)              |
| AWG-WARM-UP (OTS)         | MANSWTO THIRD (EXT-SREF) | SSM-ST4 (NE-SREF)         |
| CLDRESTART (EQPT)         | MANSWTO THIRD (NE-SREF)  | SSM-ST4 (OCN)             |
| CPP-INCAPABLE (EQPT)      | MANUAL-REQ-RING (OCN)    | SSM-ST4 (TRUNK)           |
| CTNEQPT-MISMATCH (EQPT)   | MANUAL-REQ-SPAN (2R)     | SSM-STU (BITS)            |
| DS3-MISM (DS3)            | MANUAL-REQ-SPAN (EC1)    | SSM-STU (DS1)             |
| ETH-LINKLOSS (NE)         | MANUAL-REQ-SPAN (ESCON)  | SSM-STU (E1)              |
| EXERCISE-RING-FAIL (OCN)  | MANUAL-REQ-SPAN (FC)     | SSM-STU (NE-SREF)         |
| EXERCISE-SPAN-FAIL (OCN)  | MANUAL-REQ-SPAN (GE)     | SSM-STU (OCN)             |
| FAILTOSW (2R)             | MANUAL-REQ-SPAN (ISC)    | SSM-STU (TRUNK)           |
| FAILTOSW (EQPT)           | MANUAL-REQ-SPAN (OCN)    | SSM-TNC (BITS)            |
| FAILTOSW (ESCON)          | MANUAL-REQ-SPAN (TRUNK)  | SSM-TNC (NE-SREF)         |
| FAILTOSW (FC)             | MS-DEG (E1)              | SSM-TNC (OCN)             |
| FAILTOSW (GE)             | MS-EXC (E1)              | SSM-TNC (TRUNK)           |
| FAILTOSW (ISC)            | MT-OCHNC (OTS)           | STS-SQUELCH-L (OCN)       |
| FAILTOSW (OCN)            | NO-CONFIG (EQPT)         | SW-MISMATCH (EQPT)        |
| FAILTOSW (TRUNK)          | OCHNC-INC (OCHNC-CONN)   | SWTOPRI (EXT-SREF)        |
| FAILTOSW-PATH (STSMON)    | OCHTERM-INC (OCH-TERM)   | SWTOPRI (NE-SREF)         |
| FAILTOSW-PATH (VT-MON)    | ODUK-SD-PM (TRUNK)       | SWTOSEC (EXT-SREF)        |
| FAILTOSWR (OCN)           | ODUK-SF-PM (TRUNK)       | SWTOSEC (NE-SREF)         |
| FAILTOSWS (OCN)           | OOU-TPT (STSTRM)         | SWTO THIRD (EXT-SREF)     |
| FAPS (FCMR)               | OOU-TPT (VT-TERM)        | SWTO THIRD (NE-SREF)      |
| FAPS (TRUNK)              | OPEN-SLOT (EQPT)         | SYNC-FREQ (BITS)          |
| FDI (OCH-TERM)            | OSRION (AOTS)            | SYNC-FREQ (DS1)           |
| FDI (OCH)                 | OSRION (OTS)             | SYNC-FREQ (E1)            |
| FE-AIS (DS3)              | OTUK-SD (TRUNK)          | SYNC-FREQ (OCN)           |
| FE-DS1-MULTLOS (DS3)      | OTUK-SF (TRUNK)          | SYNC-FREQ (TRUNK)         |
| FE-DS1-NSA (DS3)          | OUT-OF-SYNC (ISC)        | TEMP-MISM (NE)            |
| FE-DS1-SA (DS3)           | PARAM-MISM (AOTS)        | TRAIL-SIGNAL-FAIL (OCH)   |
| FE-DS1-SNGLLOS (DS3)      | PARAM-MISM (OCH-TERM)    | TRAIL-SIGNAL-FAIL (TRUNK) |
| FE-DS3-NSA (DS3)          | PARAM-MISM (OCH)         | TX-IDLE (DS1)             |
| FE-DS3-SA (DS3)           | PARAM-MISM (OMS)         | TX-RAI (DS1)              |
| FE-EQPT-NSA (DS3)         | PARAM-MISM (OTS)         | TX-RAI (DS3)              |
| FE-FRCDWKS WBK-SPAN (OCN) | PDI-P (STSMON)           | TX-RAI (E1)               |
| FE-FRCDWKS WPR-RING (EC1) | PDI-P (STSTRM)           | UNC-WORD (TRUNK)          |

**Table 2-4** ONS 15454 NA Conditions List (continued)

|                           |                         |                    |
|---------------------------|-------------------------|--------------------|
| FE-FRCDWKSWPR-RING (OCN)  | PMI (OMS)               | VCG-DEG (VCG)      |
| FE-FRCDWKSWPR-SPAN (OCN)  | PMI (OTS)               | VCG-DOWN (VCG)     |
| FE-IDLE (DS3)             | PORT-MISMATCH (FCMR)    | VOLT-MISM (PWR)    |
| FE-LOCKOUTOFPR-SPAN (OCN) | RAI (DS1)               | VT-SQUELCH-L (OCN) |
| FE-LOF (DS3)              | RAI (DS3)               | WKSWPR (2R)        |
| FE-LOS (DS3)              | RAI (E1)                | WKSWPR (EQPT)      |
| FE-MANWKSWBK-SPAN (OCN)   | RING-SW-EAST (OCN)      | WKSWPR (ESCON)     |
| FE-MANWKSWPR-RING (EC1)   | RING-SW-WEST (OCN)      | WKSWPR (FC)        |
| FE-MANWKSWPR-RING (OCN)   | ROLL (STSMON)           | WKSWPR (GE)        |
| FE-MANWKSWPR-SPAN (OCN)   | ROLL (STSTRM)           | WKSWPR (ISC)       |
| FE-SD-SPAN (OCN)          | ROLL (VT-MON)           | WKSWPR (OCN)       |
| FE-SF-RING (OCN)          | ROLL (VT-TERM)          | WKSWPR (STSMON)    |
| FE-SF-SPAN (OCN)          | ROLL-PEND (STSMON)      | WKSWPR (VT-MON)    |
| FORCED-REQ (EQPT)         | ROLL-PEND (VT-MON)      | WTR (2R)           |
| FORCED-REQ (ML1000)       | ROLL-PEND (VT-TERM)     | WTR (EC1)          |
| FORCED-REQ (ML100T)       | RPR-PASSTHR (RPRIF)     | WTR (EQPT)         |
| FORCED-REQ (MLFX)         | RPR-PROT-ACTIVE (RPRIF) | WTR (ESCON)        |
| FORCED-REQ (MLMR)         | RPR-SD (ML1000)         | WTR (FC)           |
| FORCED-REQ (STSMON)       | RPR-SD (ML100T)         | WTR (GE)           |
| FORCED-REQ (VT-MON)       | RPR-SD (MLFX)           | WTR (ISC)          |
| FORCED-REQ-RING (OCN)     | RPR-SD (MLMR)           | WTR (ML1000)       |
| FORCED-REQ-SPAN (2R)      | RPR-SF (ML1000)         | WTR (ML100T)       |
| FORCED-REQ-SPAN (EC1)     | RPR-SF (ML100T)         | WTR (MLFX)         |
| FORCED-REQ-SPAN (ESCON)   | RPR-SF (MLFX)           | WTR (MLMR)         |
| FORCED-REQ-SPAN (FC)      | RPR-SF (MLMR)           | WTR (OCN)          |
| FORCED-REQ-SPAN (GE)      | RPRW (ML1000)           | WTR (STSMON)       |
| FORCED-REQ-SPAN (ISC)     | RPRW (ML100T)           | WTR (TRUNK)        |
| FORCED-REQ-SPAN (OCN)     | RPRW (MLFX)             | WTR (VT-MON)       |
| FORCED-REQ-SPAN (TRUNK)   | RUNCFG-SAVENEED (EQPT)  | —                  |
| FRCDSWTOINT (NE-SREF)     | SD (DS1)                | —                  |

## 2.1.5 NR Conditions

Table 2-5 alphabetically lists ONS 15454 Not Reported (NR) conditions.



**Table 2-5** ONS 15454 NR Conditions List

|                     |                       |                    |
|---------------------|-----------------------|--------------------|
| AIS (BITS)          | ERFI-P-CONN (STSMON)  | OTUK-BDI (TRUNK)   |
| AIS (DS1)           | ERFI-P-CONN (STSTRM)  | RFI (TRUNK)        |
| AIS (DS3)           | ERFI-P-PAYLD (STSMON) | RFI-L (EC1)        |
| AIS (E1)            | ERFI-P-PAYLD (STSTRM) | RFI-L (OCN)        |
| AIS (FUDC)          | ERFI-P-SRVR (STSMON)  | RFI-L (TRUNK)      |
| AIS (MSUDC)         | ERFI-P-SRVR (STSTRM)  | RFI-P (STSMON)     |
| AIS (TRUNK)         | ODUK-1-AIS-PM (TRUNK) | RFI-P (STSTRM)     |
| AIS-L (EC1)         | ODUK-2-AIS-PM (TRUNK) | RFI-V (VT-MON)     |
| AIS-L (OCN)         | ODUK-3-AIS-PM (TRUNK) | RFI-V (VT-TERM)    |
| AIS-L (TRUNK)       | ODUK-4-AIS-PM (TRUNK) | ROLL-PEND (STSTRM) |
| AIS-P (STSMON)      | ODUK-AIS-PM (TRUNK)   | TX-AIS (DS1)       |
| AIS-P (STSTRM)      | ODUK-BDI-PM (TRUNK)   | TX-AIS (DS3)       |
| AIS-V (VT-MON)      | ODUK-LCK-PM (TRUNK)   | TX-AIS (E1)        |
| AIS-V (VT-TERM)     | ODUK-OCI-PM (TRUNK)   | TX-LOF (DS1)       |
| AUTOSW-AIS (STSMON) | OTUK-AIS (TRUNK)      | TX-LOF (E1)        |
| AUTOSW-AIS (VT-MON) | —                     | —                  |

## 2.2 Alarms and Conditions Listed By Alphabetical Entry

Table 2-6 alphabetically lists all ONS 15454 alarms and conditions.

**Table 2-6** ONS 15454 Alarm and Condition Alphabetical List

|                |                           |                       |
|----------------|---------------------------|-----------------------|
| —              | GFP-EX-MISMATCH (FCMR)    | PLM-P (STSTRM)        |
| —              | GFP-EX-MISMATCH (GFP-FAC) | PLM-V (VT-MON)        |
| —              | GFP-LFD (CE1000)          | PLM-V (VT-TERM)       |
| —              | GFP-LFD (CE100T)          | PMI (OMS)             |
| AIS (BITS)     | GFP-LFD (CEMR)            | PMI (OTS)             |
| AIS (DS1)      | GFP-LFD (FCMR)            | PORT-FAIL (OCH)       |
| AIS (DS3)      | GFP-LFD (GFP-FAC)         | PORT-MISMATCH (CEMR)  |
| AIS (E1)       | GFP-LFD (ML1000)          | PORT-MISMATCH (FCMR)  |
| AIS (FUDC)     | GFP-LFD (ML100T)          | PORT-MISMATCH (MLMR)  |
| AIS (MSUDC)    | GFP-LFD (MLFX)            | PRC-DUPID (OCN)       |
| AIS (TRUNK)    | GFP-LFD (MLMR)            | PROTNA (EQPT)         |
| AIS-L (EC1)    | GFP-NO-BUFFERS (FCMR)     | PROV-MISMATCH (PPM)   |
| AIS-L (OCN)    | GFP-NO-BUFFERS (GFP-FAC)  | PROV-MISMATCH (TRUNK) |
| AIS-L (TRUNK)  | GFP-UP-MISMATCH (CE1000)  | PTIM (TRUNK)          |
| AIS-P (STSMON) | GFP-UP-MISMATCH (CE100T)  | PWR-FAIL-A (EQPT)     |

Table 2-6 ONS 15454 Alarm and Condition Alphabetical List (continued)

|                         |                           |                              |
|-------------------------|---------------------------|------------------------------|
| AIS-P (STSTRM)          | GFP-UP-MISMATCH (CEMR)    | PWR-FAIL-B (EQPT)            |
| AIS-V (VT-MON)          | GFP-UP-MISMATCH (FCMR)    | PWR-FAIL-RET-A (EQPT)        |
| AIS-V (VT-TERM)         | GFP-UP-MISMATCH (GFP-FAC) | PWR-FAIL-RET-B (EQPT)        |
| ALS (2R)                | GFP-UP-MISMATCH (ML1000)  | RAI (DS1)                    |
| ALS (AOTS)              | GFP-UP-MISMATCH (ML100T)  | RAI (DS3)                    |
| ALS (ESCON)             | GFP-UP-MISMATCH (MLFX)    | RAI (E1)                     |
| ALS (FC)                | GFP-UP-MISMATCH (MLMR)    | RCVR-MISS (DS1)              |
| ALS (GE)                | HELLO (OCN)               | RCVR-MISS (E1)               |
| ALS (ISC)               | HELLO (TRUNK)             | RSV-RT-EXCD-RINGLET0 (RPRIF) |
| ALS (OCN)               | HIBATVG (PWR)             | RSV-RT-EXCD-RINGLET1 (RPRIF) |
| ALS (TRUNK)             | HI-CCVOLT (BITS)          | RFI (TRUNK)                  |
| ALS-DISABLED (EQPT)     | HI-LASERBIAS (2R)         | RFI-L (EC1)                  |
| AMPLI-INIT (AOTS)       | HI-LASERBIAS (EQPT)       | RFI-L (OCN)                  |
| APC-CORR-SKIPPED (AOTS) | HI-LASERBIAS (ESCON)      | RFI-L (TRUNK)                |
| APC-CORR-SKIPPED (OCH)  | HI-LASERBIAS (FC)         | RFI-P (STSMON)               |
| APC-CORR-SKIPPED (OMS)  | HI-LASERBIAS (GE)         | RFI-P (STSTRM)               |
| APC-CORR-SKIPPED (OTS)  | HI-LASERBIAS (ISC)        | RFI-V (VT-MON)               |
| APC-DISABLED (NE)       | HI-LASERBIAS (OCN)        | RFI-V (VT-TERM)              |
| APC-DISABLED (AOTS)     | HI-LASERBIAS (PPM)        | RING-ID-MIS (OCN)            |
| APC-DISABLED (EQPT)     | HI-LASERBIAS (TRUNK)      | RING-ID-MIS (OSC-RING)       |
| APC-DISABLED (NE)       | HI-LASERTEMP (EQPT)       | RING-MISMATCH (OCN)          |
| APC-DISABLED (OCH)      | HI-LASERTEMP (OCN)        | RING-SW-EAST (OCN)           |
| APC-DISABLED (OMS)      | HI-LASERTEMP (PPM)        | RING-SW-WEST (OCN)           |
| APC-DISABLED (OTS)      | HI-RXPOWER (2R)           | ROLL (STSMON)                |
| APC-DISABLED (SHELF)    | HI-RXPOWER (ESCON)        | ROLL (STSTRM)                |
| APC-END (NE)            | HI-RXPOWER (FC)           | ROLL (VT-MON)                |
| APC-OUT-OF-RANGE (AOTS) | HI-RXPOWER (GE)           | ROLL (VT-TERM)               |
| APC-OUT-OF-RANGE (OCH)  | HI-RXPOWER (ISC)          | ROLL-PEND (STSMON)           |
| APC-OUT-OF-RANGE (OMS)  | HI-RXPOWER (OCN)          | ROLL-PEND (STSTRM)           |
| APC-OUT-OF-RANGE (OTS)  | HI-RXPOWER (TRUNK)        | ROLL-PEND (VT-MON)           |
| APC-WRONG-GAIN (AOTS)   | HITEMP (EQPT)             | ROLL-PEND (VT-TERM)          |
| APSB (OCN)              | HITEMP (NE)               | RPR-PASSTHR (RPRIF)          |
| APSCDFLTK (OCN)         | HI-TXPOWER (2R)           | RPR-PEER-MISS (RPRIF)        |
| APSC-IMP (OCN)          | HI-TXPOWER (EQPT)         | RPR-PROT-ACTIVE (RPRIF)      |
| APSCINCON (OCN)         | HI-TXPOWER (ESCON)        | RPR-PROT-CONFIG-MISM (RPRIF) |
| APSCM (OCN)             | HI-TXPOWER (FC)           | RPR-RI-FAIL (RPRIF)          |
| APSCNMIS (OCN)          | HI-TXPOWER (GE)           | RPR-SD (ML1000)              |

**Table 2-6** ONS 15454 Alarm and Condition Alphabetical List (continued)

|                         |                           |                            |
|-------------------------|---------------------------|----------------------------|
| APSIMP (OCN)            | HI-TXPOWER (ISC)          | RPR-SD (ML100T)            |
| APS-INV-PRIM (OCN)      | HI-TXPOWER (OCN)          | RPR-SD (MLFX)              |
| APSM (OCN)              | HI-TXPOWER (PPM)          | RPR-SD (MLMR)              |
| APS-PRIM-FAC (OCN)      | HI-TXPOWER (TRUNK)        | RPR-SF (ML1000)            |
| APS-PRIM-SEC-MISM (OCN) | HLDOVRSYNC (NE-SREF)      | RPR-SF (ML100T)            |
| AS-CMD (2R)             | IDLE (DS1)                | RPR-SF (MLFX)              |
| AS-CMD (AOTS)           | I-HITEMP (NE)             | RPR-SF (MLMR)              |
| AS-CMD (BPLANE)         | ILK-FAIL (TRUNK)          | RPR-SPAN-MISMATCH (ML1000) |
| AS-CMD (CE1000)         | IMPROPRMVL (EQPT)         | RPR-SPAN-MISMATCH (ML100T) |
| AS-CMD (CE100T)         | IMPROPRMVL (PPM)          | RPR-SPAN-MISMATCH (MLFX)   |
| AS-CMD (CEMR)           | INC-ISD (DS3)             | RPR-SPAN-MISMATCH (MLMR)   |
| AS-CMD (DS1)            | INH SWPR (EQPT)           | RPRW (ML1000)              |
| AS-CMD (DS3)            | INH SWWKG (EQPT)          | RPRW (ML100T)              |
| AS-CMD (E1)             | INTRUSION-PSWD (NE)       | RPRW (MLFX)                |
| AS-CMD (E1000F)         | INVMACADR (AIP)           | RUNCFG-SAVENEED (EQPT)     |
| AS-CMD (E100T)          | IOSCFGCOPY (EQPT)         | SD (DS1)                   |
| AS-CMD (EC1)            | ISIS-ADJ-FAIL (OCN)       | SD (DS3)                   |
| AS-CMD (EQPT)           | ISIS-ADJ-FAIL (TRUNK)     | SD (TRUNK)                 |
| AS-CMD (ESCON)          | KB-PASSTHR (OCN)          | SD-L (EC1)                 |
| AS-CMD (FC)             | KBYTE-APS-CHAN-FAIL (OCN) | SD-L (OCN)                 |
| AS-CMD (FCMR)           | LAN-POL-REV (NE)          | SD-L (TRUNK)               |
| AS-CMD (G1000)          | LASER-APR (AOTS)          | SD-P (STSMON)              |
| AS-CMD (GE)             | LASERBIAS-DEG (AOTS)      | SD-P (STSTRM)              |
| AS-CMD (GFP-FAC)        | LASERBIAS-DEG (OTS)       | SD-V (VT-MON)              |
| AS-CMD (ISC)            | LASERBIAS-FAIL (AOTS)     | SD-V (VT-TERM)             |
| AS-CMD (ML1000)         | LASEREOL (OCN)            | SF (DS1)                   |
| AS-CMD (ML100T)         | LASERTEMP-DEG (AOTS)      | SF (DS3)                   |
| AS-CMD (MLFX)           | LCAS-CRC (STSTRM)         | SF (TRUNK)                 |
| AS-CMD (MLMR)           | LCAS-CRC (VT-TERM)        | SF-L (EC1)                 |
| AS-CMD (NE)             | LCAS-RX-DNU (STSTRM)      | SF-L (OCN)                 |
| AS-CMD (OCH)            | LCAS-RX-DNU (VT-TERM)     | SF-L (TRUNK)               |
| AS-CMD (OCN)            | LCAS-RX-FAIL (STSTRM)     | SF-P (STSMON)              |
| AS-CMD (OMS)            | LCAS-RX-FAIL (VT-TERM)    | SF-P (STSTRM)              |
| AS-CMD (OTS)            | LCAS-RX-GRP-ERR (STSTRM)  | SFTWDOWN (EQPT)            |
| AS-CMD (PPM)            | LCAS-RX-GRP-ERR (VT-TERM) | SF-V (VT-MON)              |
| AS-CMD (PWR)            | LCAS-TX-ADD (STSTRM)      | SF-V (VT-TERM)             |
| AS-CMD (SHELF)          | LCAS-TX-ADD (VT-TERM)     | SHELF-COMM-FAIL (SHELF)    |

Table 2-6 ONS 15454 Alarm and Condition Alphabetical List (continued)

|                      |                         |                            |
|----------------------|-------------------------|----------------------------|
| AS-CMD (TRUNK)       | LCAS-TX-DNU (STSTRM)    | SH-IL-VAR-DEG-HIGH (OTS)   |
| AS-MT (2R)           | LCAS-TX-DNU (VT-TERM)   | SH-IL-VAR-DEG-LOW (OTS)    |
| AS-MT (AOTS)         | LINK-KEEPALIVE (ML1000) | SHUTTER-OPEN (OTS)         |
| AS-MT (CE1000)       | LINK-KEEPALIVE (ML100T) | SIGLOSS (ESCON)            |
| AS-MT (CE100T)       | LINK-KEEPALIVE (MLFX)   | SIGLOSS (FC)               |
| AS-MT (CEMR)         | LINK-KEEPALIVE (MLMR)   | SIGLOSS (FCMR)             |
| AS-MT (DS1)          | LKOUTPR-S (OCN)         | SIGLOSS (GE)               |
| AS-MT (DS3)          | LMP-FAIL (CTRL)         | SIGLOSS (ISC)              |
| AS-MT (E1)           | LMP-FAIL (GE)           | SIGLOSS (TRUNK)            |
| AS-MT (EC1)          | LMP-FAIL (OCN)          | SNTP-HOST (NE)             |
| AS-MT (EQPT)         | LMP-FAIL (TLINK)        | SPANLEN-OUT-OF-RANGE (OTS) |
| AS-MT (ESCON)        | LMP-SD (GE)             | SPAN-NOT-MEASURED (OTS)    |
| AS-MT (FC)           | LMP-SD (OCN)            | SPAN-SW-EAST (OCN)         |
| AS-MT (FCMR)         | LMP-SF (GE)             | SPAN-SW-WEST (OCN)         |
| AS-MT (G1000)        | LMP-SF (OCN)            | SQM (STSTRM)               |
| AS-MT (GE)           | LMP-UNALLOC (GE)        | SQM (VT-TERM)              |
| AS-MT (GFP-FAC)      | LMP-UNALLOC (OCN)       | SQUELCH (OCN)              |
| AS-MT (ISC)          | LOA (VCG)               | SQUELCHED (2R)             |
| AS-MT (ML1000)       | LOCKOUT-REQ (2R)        | SQUELCHED (ESCON)          |
| AS-MT (ML100T)       | LOCKOUT-REQ (EQPT)      | SQUELCHED (FC)             |
| AS-MT (MLFX)         | LOCKOUT-REQ (ESCON)     | SQUELCHED (GE)             |
| AS-MT (MLMR)         | LOCKOUT-REQ (FC)        | SQUELCHED (ISC)            |
| AS-MT (OCH)          | LOCKOUT-REQ (GE)        | SQUELCHED (OCN)            |
| AS-MT (OCN)          | LOCKOUT-REQ (ISC)       | SQUELCHED (TRUNK)          |
| AS-MT (OMS)          | LOCKOUT-REQ (OCN)       | SSM-DUS (BITS)             |
| AS-MT (OTS)          | LOCKOUT-REQ (STSMON)    | SSM-DUS (DS1)              |
| AS-MT (PPM)          | LOCKOUT-REQ (TRUNK)     | SSM-DUS (E1)               |
| AS-MT (SHELF)        | LOCKOUT-REQ (VT-MON)    | SSM-DUS (OCN)              |
| AS-MT (TRUNK)        | LOF (BITS)              | SSM-DUS (TRUNK)            |
| AS-MT-OOG (STSTRM)   | LOF (DS1)               | SSM-FAIL (BITS)            |
| AS-MT-OOG (VT-TERM)  | LOF (DS3)               | SSM-FAIL (DS1)             |
| AUD-LOG-LOSS (NE)    | LOF (E1)                | SSM-FAIL (E1)              |
| AUD-LOG-LOW (NE)     | LOF (EC1)               | SSM-FAIL (OCN)             |
| AUTOLSROFF (OCN)     | LOF (OCN)               | SSM-FAIL (TRUNK)           |
| AUTONEG-RFI (ML1000) | LOF (STSTRM)            | SSM-LNC (BITS)             |
| AUTORESET (EQPT)     | LOF (TRUNK)             | SSM-LNC (NE-SREF)          |
| AUTOSW-AIS (STSMON)  | LO-LASERBIAS (EQPT)     | SSM-LNC (OCN)              |

**Table 2-6** ONS 15454 Alarm and Condition Alphabetical List (continued)

|                        |                     |                      |
|------------------------|---------------------|----------------------|
| AUTOSW-AIS (VT-MON)    | LO-LASERBIAS (OCN)  | SSM-LNC (TRUNK)      |
| AUTOSW-LOP (STSMON)    | LO-LASERBIAS (PPM)  | SSM-OFF (BITS)       |
| AUTOSW-LOP (VT-MON)    | LO-LASERTEMP (EQPT) | SSM-OFF (DS1)        |
| AUTOSW-PDI (STSMON)    | LO-LASERTEMP (OCN)  | SSM-OFF (E1)         |
| AUTOSW-PDI (VT-MON)    | LO-LASERTEMP (PPM)  | SSM-OFF (OCN)        |
| AUTOSW-SDBER (STSMON)  | LOM (STSMON)        | SSM-OFF (TRUNK)      |
| AUTOSW-SDBER (VT-MON)  | LOM (STSTRM)        | SSM-PRC (BITS)       |
| AUTOSW-SFBER (STSMON)  | LOM (TRUNK)         | SSM-PRC (NE-SREF)    |
| AUTOSW-SFBER (VT-MON)  | LOM (VT-TERM)       | SSM-PRC (OCN)        |
| AUTOSW-UNEQ (STSMON)   | LOP-P (STSMON)      | SSM-PRC (TRUNK)      |
| AUTOSW-UNEQ (VT-MON)   | LOP-P (STSTRM)      | SSM-PRS (BITS)       |
| AWG-DEG (OTS)          | LOP-V (VT-MON)      | SSM-PRS (DS1)        |
| AWG-FAIL (OTS)         | LOP-V (VT-TERM)     | SSM-PRS (E1)         |
| AWG-OVERTEMP (OTS)     | LO-RXPOWER (2R)     | SSM-PRS (NE-SREF)    |
| AWG-WARM-UP (OTS)      | LO-RXPOWER (ESCON)  | SSM-PRS (OCN)        |
| BAT-FAIL (PWR)         | LO-RXPOWER (FC)     | SSM-PRS (TRUNK)      |
| BKUPMEMP (EQPT)        | LO-RXPOWER (GE)     | SSM-RES (BITS)       |
| BLSROSYNC (OCN)        | LO-RXPOWER (ISC)    | SSM-RES (DS1)        |
| BLSR-SW-VER-MISM (OCN) | LO-RXPOWER (OCN)    | SSM-RES (E1)         |
| BPV (BITS)             | LO-RXPOWER (TRUNK)  | SSM-RES (NE-SREF)    |
| CARLOSS (CE1000)       | LOS (2R)            | SSM-RES (OCN)        |
| CARLOSS (CE100T)       | LOS (BITS)          | SSM-RES (TRUNK)      |
| CARLOSS (CEMR)         | LOS (DS1)           | SSM-SDH-TN (BITS)    |
| CARLOSS (E1000F)       | LOS (DS3)           | SSM-SDH-TN (NE-SREF) |
| CARLOSS (E100T)        | LOS (E1)            | SSM-SDH-TN (OCN)     |
| CARLOSS (EQPT)         | LOS (EC1)           | SSM-SDH-TN (TRUNK)   |
| CARLOSS (FC)           | LOS (ESCON)         | SSM-SETS (BITS)      |
| CARLOSS (G1000)        | LOS (FUDC)          | SSM-SETS (NE-SREF)   |
| CARLOSS (GE)           | LOS (ISC)           | SSM-SETS (OCN)       |
| CARLOSS (ISC)          | LOS (MSUDC)         | SSM-SETS (TRUNK)     |
| CARLOSS (ML1000)       | LOS (OCN)           | SSM-SMC (BITS)       |
| CARLOSS (ML100T)       | LOS (OTS)           | SSM-SMC (DS1)        |
| CARLOSS (MLFX)         | LOS (TRUNK)         | SSM-SMC (E1)         |
| CARLOSS (MLMR)         | LOS-O (OCH)         | SSM-SMC (NE-SREF)    |
| CARLOSS (TRUNK)        | LOS-O (OMS)         | SSM-SMC (OCN)        |
| CASETEMP-DEG (AOTS)    | LOS-O (OTS)         | SSM-SMC (TRUNK)      |
| CLDRESTART (EQPT)      | LOS-P (OCH)         | SSM-ST2 (BITS)       |

Table 2-6 ONS 15454 Alarm and Condition Alphabetical List (continued)

|                           |                       |                      |
|---------------------------|-----------------------|----------------------|
| COMIOXC (EQPT)            | LOS-P (OMS)           | SSM-ST2 (DS1)        |
| COMM-FAIL (EQPT)          | LOS-P (OTS)           | SSM-ST2 (E1)         |
| CONTBUS-A-18 (EQPT)       | LOS-P (TRUNK)         | SSM-ST2 (NE-SREF)    |
| CONTBUS-B-18 (EQPT)       | LO-TXPOWER (2R)       | SSM-ST2 (OCN)        |
| CONTBUS-DISABLED (EQPT)   | LO-TXPOWER (EQPT)     | SSM-ST2 (TRUNK)      |
| CONTBUS-IO-A (EQPT)       | LO-TXPOWER (ESCON)    | SSM-ST3 (BITS)       |
| CONTBUS-IO-B (EQPT)       | LO-TXPOWER (FC)       | SSM-ST3 (DS1)        |
| CPP-INCAPABLE (EQPT)      | LO-TXPOWER (GE)       | SSM-ST3 (E1)         |
| CTNEQPT-MISMATCH (EQPT)   | LO-TXPOWER (ISC)      | SSM-ST3 (NE-SREF)    |
| CTNEQPT-PBPROT (EQPT)     | LO-TXPOWER (OCN)      | SSM-ST3 (OCN)        |
| CTNEQPT-PBWORK (EQPT)     | LO-TXPOWER (PPM)      | SSM-ST3 (TRUNK)      |
| DATA-CRC (CE100T)         | LO-TXPOWER (TRUNK)    | SSM-ST3E (BITS)      |
| DATA-CRC (ML1000)         | LPBKCRS (STSMON)      | SSM-ST3E (DS1)       |
| DATA-CRC (ML100T)         | LPBKCRS (STSTRM)      | SSM-ST3E (E1)        |
| DATA-CRC (MLFX)           | LPBKDS1FE-CMD (DS1)   | SSM-ST3E (NE-SREF)   |
| DATAFLT (NE)              | LPBKDS3FEAC (DS3)     | SSM-ST3E (OCN)       |
| DBOSYNC (NE)              | LPBKDS3FEAC-CMD (DS3) | SSM-ST3E (TRUNK)     |
| DCU-LOSS-FAIL (OTS)       | LPBKFACILITY (CE1000) | SSM-ST4 (BITS)       |
| DS3-MISM (DS3)            | LPBKFACILITY (CE100T) | SSM-ST4 (DS1)        |
| DSP-COMM-FAIL (TRUNK)     | LPBKFACILITY (CEMR)   | SSM-ST4 (E1)         |
| DSP-FAIL (TRUNK)          | LPBKFACILITY (DS1)    | SSM-ST4 (NE-SREF)    |
| DUP-IPADDR (NE)           | LPBKFACILITY (DS3)    | SSM-ST4 (OCN)        |
| DUP-NODENAME (NE)         | LPBKFACILITY (E1)     | SSM-ST4 (TRUNK)      |
| DUP-SHELF-ID (SHELF)      | LPBKFACILITY (EC1)    | SSM-STU (BITS)       |
| EHIBATVG (PWR)            | LPBKFACILITY (ESCON)  | SSM-STU (DS1)        |
| ELWBATVG (PWR)            | LPBKFACILITY (FC)     | SSM-STU (E1)         |
| ENCAP-MISMATCH-P (STSTRM) | LPBKFACILITY (FCMR)   | SSM-STU (NE-SREF)    |
| EOC (OCN)                 | LPBKFACILITY (G1000)  | SSM-STU (OCN)        |
| EOC (TRUNK)               | LPBKFACILITY (GE)     | SSM-STU (TRUNK)      |
| EOC-L (OCN)               | LPBKFACILITY (ISC)    | SSM-TNC (BITS)       |
| EOC-L (TRUNK)             | LPBKFACILITY (MLMR)   | SSM-TNC (NE-SREF)    |
| EQPT (AICI-AEP)           | LPBKFACILITY (OCN)    | SSM-TNC (OCN)        |
| EQPT (AICI-AIE)           | LPBKFACILITY (TRUNK)  | SSM-TNC (TRUNK)      |
| EQPT (EQPT)               | LPBKTERMINAL (CE1000) | STS-SQUELCH-L (OCN)  |
| EQPT (PPM)                | LPBKTERMINAL (CE100T) | SW-MISMATCH (EQPT)   |
| EQPT-DIAG (EQPT)          | LPBKTERMINAL (CEMR)   | SWMTXMOD-PROT (EQPT) |
| EQPT-MISS (FAN)           | LPBKTERMINAL (DS1)    | SWMTXMOD-WORK (EQPT) |

**Table 2-6 ONS 15454 Alarm and Condition Alphabetical List (continued)**

|                             |                         |                      |
|-----------------------------|-------------------------|----------------------|
| ERFI-P-CONN (STSMON)        | LPBKTERMINAL (DS3)      | SWTOPRI (EXT-SREF)   |
| ERFI-P-CONN (STSTRM)        | LPBKTERMINAL (E1)       | SWTOPRI (NE-SREF)    |
| ERFI-P-PAYLD (STSMON)       | LPBKTERMINAL (EC1)      | SWTOSEC (EXT-SREF)   |
| ERFI-P-PAYLD (STSTRM)       | LPBKTERMINAL (ESCON)    | SWTOSEC (NE-SREF)    |
| ERFI-P-SRVR (STSMON)        | LPBKTERMINAL (FC)       | SWTOTHIRD (EXT-SREF) |
| ERFI-P-SRVR (STSTRM)        | LPBKTERMINAL (FCMR)     | SWTOTHIRD (NE-SREF)  |
| ERROR-CONFIG (EQPT)         | LPBKTERMINAL (G1000)    | SYNC-FREQ (BITS)     |
| ETH-LINKLOSS (NE)           | LPBKTERMINAL (GE)       | SYNC-FREQ (DS1)      |
| E-W-MISMATCH (OCN)          | LPBKTERMINAL (ISC)      | SYNC-FREQ (E1)       |
| EXCCOL (EQPT)               | LPBKTERMINAL (MLMR)     | SYNC-FREQ (OCN)      |
| EXERCISE-RING-FAIL (OCN)    | LPBKTERMINAL (OCN)      | SYNC-FREQ (TRUNK)    |
| EXERCISE-SPAN-FAIL (OCN)    | LPBKTERMINAL (TRUNK)    | SYNCLOSS (FC)        |
| EXT (ENVALRM)               | LWBATVG (PWR)           | SYNCLOSS (FCMR)      |
| EXTRA-TRAF-PREEMPT (OCN)    | MAN-REQ (EQPT)          | SYNCLOSS (GE)        |
| FAILTOSW (2R)               | MAN-REQ (ML1000)        | SYNCLOSS (ISC)       |
| FAILTOSW (EQPT)             | MAN-REQ (ML100T)        | SYNCLOSS (TRUNK)     |
| FAILTOSW (ESCON)            | MAN-REQ (MLFX)          | SYNCPRI (EXT-SREF)   |
| FAILTOSW (FC)               | MAN-REQ (MLMR)          | SYNCPRI (NE-SREF)    |
| FAILTOSW (GE)               | MAN-REQ (STSMON)        | SYNCSEC (EXT-SREF)   |
| FAILTOSW (ISC)              | MAN-REQ (VT-MON)        | SYNCSEC (NE-SREF)    |
| FAILTOSW (OCN)              | MANRESET (EQPT)         | SYNCTHIRD (EXT-SREF) |
| FAILTOSW (TRUNK)            | MANSWTOINT (NE-SREF)    | SYNCTHIRD (NE-SREF)  |
| FAILTOSW-PATH (STSMON)      | MANSWTOPRI (EXT-SREF)   | SYSBOOT (NE)         |
| FAILTOSW-PATH (VT-MON)      | MANSWTOPRI (NE-SREF)    | TEMP-MISM (NE)       |
| FAILTOSWR (OCN)             | MANSWTOSEC (EXT-SREF)   | TIM (OCN)            |
| FAILTOSWS (OCN)             | MANSWTOSEC (NE-SREF)    | TIM (TRUNK)          |
| FAN (FAN)                   | MANSWTOTHIRD (EXT-SREF) | TIM-MON (OCN)        |
| FAPS (FCMR)                 | MANSWTOTHIRD (NE-SREF)  | TIM-MON (TRUNK)      |
| FAPS (TRUNK)                | MANUAL-REQ-RING (OCN)   | TIM-P (STSMON)       |
| FAPS-CONFIG-MISMATCH (EQPT) | MANUAL-REQ-SPAN (2R)    | TIM-P (STSTRM)       |
| FC-DE-NES (FC)              | MANUAL-REQ-SPAN (EC1)   | TIM-S (EC1)          |
| FC-DE-NES (FCMR)            | MANUAL-REQ-SPAN (ESCON) | TIM-S (OCN)          |
| FC-DE-NES (TRUNK)           | MANUAL-REQ-SPAN (FC)    | TIM-V (VT-MON)       |
| FC-NO-CREDITS (FC)          | MANUAL-REQ-SPAN (GE)    | TIM-V (VT-TERM)      |
| FC-NO-CREDITS (FCMR)        | MANUAL-REQ-SPAN (ISC)   | TPTFAIL (CE1000)     |
| FC-NO-CREDITS (TRUNK)       | MANUAL-REQ-SPAN (OCN)   | TPTFAIL (CE100T)     |
| FDI (OCH)                   | MANUAL-REQ-SPAN (TRUNK) | TPTFAIL (CEMR)       |

Table 2-6 ONS 15454 Alarm and Condition Alphabetical List (continued)

|                           |                        |                           |
|---------------------------|------------------------|---------------------------|
| FDI (OCH-TERM)            | MAX-STATIONS (RPRIF)   | TPTFAIL (FCMR)            |
| FE-AIS (DS3)              | MEA (AIP)              | TPTFAIL (G1000)           |
| FEC-MISM (TRUNK)          | MEA (BIC)              | TPTFAIL (ML1000)          |
| FE-DS1-MULTLOS (DS3)      | MEA (EQPT)             | TPTFAIL (ML100T)          |
| FE-DS1-NSA (DS3)          | MEA (FAN)              | TPTFAIL (MLFX)            |
| FE-DS1-SA (DS3)           | MEA (PPM)              | TPTFAIL (MLMR)            |
| FE-DS1-SNGLLOS (DS3)      | MEA (SHELF)            | TRAIL-SIGNAL-FAIL (OCH)   |
| FE-DS3-NSA (DS3)          | MEM-GONE (EQPT)        | TRAIL-SIGNAL-FAIL (TRUNK) |
| FE-DS3-SA (DS3)           | MEM-LOW (EQPT)         | TRMT (DS1)                |
| FE-EQPT-NSA (DS3)         | MFGMEM (AICI-AEP)      | TRMT (E1)                 |
| FE-FRCDWKSWBK-SPAN (OCN)  | MFGMEM (AICI-AIE)      | TRMT-MISS (DS1)           |
| FE-FRCDWKSWPR-RING (EC1)  | MFGMEM (AIP)           | TRMT-MISS (E1)            |
| FE-FRCDWKSWPR-RING (OCN)  | MFGMEM (BPLANE)        | TX-AIS (DS1)              |
| FE-FRCDWKSWPR-SPAN (OCN)  | MFGMEM (FAN)           | TX-AIS (DS3)              |
| FE-IDLE (DS3)             | MFGMEM (PPM)           | TX-AIS (E1)               |
| FE-LOCKOUTOFPR-SPAN (OCN) | MS-DEG (E1)            | TX-IDLE (DS1)             |
| FE-LOF (DS3)              | MS-EXC (E1)            | TX-LOF (DS1)              |
| FE-LOS (DS3)              | MT-OCHNC (OTS)         | TX-LOF (E1)               |
| FE-MANWKSWBK-SPAN (OCN)   | NO-CONFIG (EQPT)       | TX-RAI (DS1)              |
| FE-MANWKSWPR-RING (EC1)   | NON-CISCO-PPM (PPM)    | TX-RAI (DS3)              |
| FE-MANWKSWPR-RING (OCN)   | OCHNC-INC (OCHNC-CONN) | TX-RAI (E1)               |
| FE-MANWKSWPR-SPAN (OCN)   | OCHTERM-INC (OCH-TERM) | UNC-WORD (TRUNK)          |
| FEPRLF (OCN)              | ODUK-1-AIS-PM (TRUNK)  | UNEQ-P (STSMON)           |
| FE-SDPRLF (OCN)           | ODUK-2-AIS-PM (TRUNK)  | UNEQ-P (STSTRM)           |
| FE-SD-SPAN (OCN)          | ODUK-3-AIS-PM (TRUNK)  | UNEQ-V (VT-MON)           |
| FE-SF-RING (OCN)          | ODUK-4-AIS-PM (TRUNK)  | UNEQ-V (VT-TERM)          |
| FE-SF-SPAN (OCN)          | ODUK-AIS-PM (TRUNK)    | UNQUAL-PPM (PPM)          |
| FIBERTEMP-DEG (AOTS)      | ODUK-BDI-PM (TRUNK)    | UT-COMM-FAIL (TRUNK)      |
| FORCED-REQ (EQPT)         | ODUK-LCK-PM (TRUNK)    | UT-FAIL (TRUNK)           |
| FORCED-REQ (ML1000)       | ODUK-OCI-PM (TRUNK)    | VCG-DEG (VCG)             |
| FORCED-REQ (ML100T)       | ODUK-SD-PM (TRUNK)     | VCG-DOWN (VCG)            |
| FORCED-REQ (MLFX)         | ODUK-SF-PM (TRUNK)     | VOA-HDEG (AOTS)           |
| FORCED-REQ (MLMR)         | ODUK-TIM-PM (TRUNK)    | VOA-HDEG (OCH)            |
| FORCED-REQ (STSMON)       | OOU-TPT (STSTRM)       | VOA-HDEG (OMS)            |
| FORCED-REQ (VT-MON)       | OOU-TPT (VT-TERM)      | VOA-HDEG (OTS)            |
| FORCED-REQ-RING (OCN)     | OPEN-SLOT (EQPT)       | VOA-HFAIL (AOTS)          |
| FORCED-REQ-SPAN (2R)      | OPWR-HDEG (AOTS)       | VOA-HFAIL (OCH)           |



**Table 2-6** ONS 15454 Alarm and Condition Alphabetical List (continued)

|                           |                       |                      |
|---------------------------|-----------------------|----------------------|
| FORCED-REQ-SPAN (EC1)     | OPWR-HDEG (OCH)       | VOA-HFAIL (OMS)      |
| FORCED-REQ-SPAN (ESCON)   | OPWR-HDEG (OCH-TERM)  | VOA-HFAIL (OTS)      |
| FORCED-REQ-SPAN (FC)      | OPWR-HDEG (OMS)       | VOA-LDEG (AOTS)      |
| FORCED-REQ-SPAN (GE)      | OPWR-HDEG (OTS)       | VOA-LDEG (OCH)       |
| FORCED-REQ-SPAN (ISC)     | OPWR-HFAIL (AOTS)     | VOA-LDEG (OMS)       |
| FORCED-REQ-SPAN (OCN)     | OPWR-HFAIL (OCH)      | VOA-LDEG (OTS)       |
| FORCED-REQ-SPAN (TRUNK)   | OPWR-HFAIL (OMS)      | VOA-LFAIL (AOTS)     |
| FP-LINK-LOSS (EQPT)       | OPWR-HFAIL (OTS)      | VOA-LFAIL (OCH)      |
| FRCDSWTOINT (NE-SREF)     | OPWR-LDEG (AOTS)      | VOA-LFAIL (OMS)      |
| FRCDSWTOPRI (EXT-SREF)    | OPWR-LDEG (OCH)       | VOA-LFAIL (OTS)      |
| FRCDSWTOPRI (NE-SREF)     | OPWR-LDEG (OCH-TERM)  | VOLT-MISM (PWR)      |
| FRCDSWTOSEC (EXT-SREF)    | OPWR-LDEG (OMS)       | VT-SQUELCH-L (OCN)   |
| FRCDSWTOSEC (NE-SREF)     | OPWR-LDEG (OTS)       | WKSWPR (2R)          |
| FRCDSWTO THIRD (EXT-SREF) | OPWR-LFAIL (AOTS)     | WKSWPR (EQPT)        |
| FRCDSWTO THIRD (NE-SREF)  | OPWR-LFAIL (OCH)      | WKSWPR (ESCON)       |
| FRNGSYNC (NE-SREF)        | OPWR-LFAIL (OCH-TERM) | WKSWPR (FC)          |
| FSTSYNC (NE-SREF)         | OPWR-LFAIL (OMS)      | WKSWPR (GE)          |
| FTA-MISMATCH (EQPT)       | OPWR-LFAIL (OTS)      | WKSWPR (ISC)         |
| FULLPASSTHR-BI (OCN)      | OSRION (AOTS)         | WKSWPR (OCN)         |
| GAIN-HDEG (AOTS)          | OSRION (OTS)          | WKSWPR (STSMON)      |
| GAIN-HFAIL (AOTS)         | OTUK-AIS (TRUNK)      | WKSWPR (VT-MON)      |
| GAIN-LDEG (AOTS)          | OTUK-BDI (TRUNK)      | WTR (2R)             |
| GAIN-LFAIL (AOTS)         | OTUK-IAE (TRUNK)      | WTR (EC1)            |
| GCC-EOC (TRUNK)           | OTUK-LOF (TRUNK)      | WTR (EQPT)           |
| GE-OOSYNC (FC)            | OTUK-SD (TRUNK)       | WTR (ESCON)          |
| GE-OOSYNC (GE)            | OTUK-SF (TRUNK)       | WTR (FC)             |
| GE-OOSYNC (ISC)           | OTUK-TIM (TRUNK)      | WTR (GE)             |
| GE-OOSYNC (TRUNK)         | OUT-OF-SYNC (FC)      | WTR (ISC)            |
| GFP-CSF (CE1000)          | OUT-OF-SYNC (GE)      | WTR (ML1000)         |
| GFP-CSF (CE100T)          | OUT-OF-SYNC (ISC)     | WTR (ML100T)         |
| GFP-CSF (CEMR)            | OUT-OF-SYNC (TRUNK)   | WTR (MLFX)           |
| GFP-CSF (FCMR)            | PARAM-MISM (AOTS)     | WTR (MLMR)           |
| GFP-CSF (GFP-FAC)         | PARAM-MISM (OCH)      | WTR (OCN)            |
| GFP-CSF (ML1000)          | PARAM-MISM (OCH-TERM) | WTR (STSMON)         |
| GFP-CSF (ML100T)          | PARAM-MISM (OMS)      | WTR (TRUNK)          |
| GFP-CSF (MLFX)            | PARAM-MISM (OTS)      | WTR (VT-MON)         |
| GFP-CSF (MLMR)            | PDI-P (STSMON)        | WVL-MISMATCH (TRUNK) |

Table 2-6 ONS 15454 Alarm and Condition Alphabetical List (continued)

|                           |                        |   |
|---------------------------|------------------------|---|
| GFP-DE-MISMATCH (FCMR)    | PDI-P (STSTRM)         | — |
| GFP-DE-MISMATCH (GFP-FAC) | PEER-NORESPONSE (EQPT) | — |
| GFP-EX-MISMATCH (CE1000)  | PLM-P (STSMON)         | — |

## 2.3 Alarm Logical Objects

The CTC alarm profile list organizes all alarms and conditions according to the logical objects they are raised against. These logical objects represent physical objects such as cards, logical objects such as circuits, or transport and signal monitoring entities such as the SONET or ITU-T G.709 optical overhead bits. One alarm can appear in multiple entries. It can be raised against multiple objects. For example, the loss of signal (LOS) alarm can be raised against the optical signal (OC-N) or the optical transport layer overhead (OTN) as well as other objects. Therefore, both OCN: LOS and OTN: LOS appear in the list (as well as the other objects).

Alarm profile list objects are defined in [Table 2-7](#).



### Note

Alarm logical object names can appear as abbreviated versions of standard terms used in the system and the documentation. For example, the “OCN” logical object refers to the OC-N signal. Logical object names or industry-standard terms are used within the entries as appropriate.

Table 2-7 Alarm Logical Object Type Definitions

| Logical Object | Definition                                                                                                                                                                      |
|----------------|---------------------------------------------------------------------------------------------------------------------------------------------------------------------------------|
| 2R             | Reshape and retransmit (used for transponder [TXP] cards).                                                                                                                      |
| AICI-AEP       | Alarm Interface Controller–International/alarm expansion panel. A combination term that refers to this platform’s AIC-I card.                                                   |
| AICI-AIE       | Alarm Interface Controller-International/Alarm Interface Extension. A combination term that refers to this platform's AIC-I card.                                               |
| AIP            | Alarm Interface Panel.                                                                                                                                                          |
| AOTS           | Amplified optical transport section. For information about AOTS alarms, refer to the “Alarm Troubleshooting” chapter in the <i>Cisco ONS 15454 DWDM Troubleshooting Guide</i> . |
| BIC            | Backplane interface connector.                                                                                                                                                  |
| BITS           | Building integrated timing supply incoming references (BITS-1, BITS-2).                                                                                                         |
| BPLANE         | The backplane.                                                                                                                                                                  |
| CE1000         | CE-1000-4 card.                                                                                                                                                                 |
| CE100T         | CE-100T-8 card.                                                                                                                                                                 |
| CEMR           | CE-MR-10 card.                                                                                                                                                                  |
| CTRL           | Control channel.                                                                                                                                                                |
| DS1            | A DS-1 line on a DS-1 or DS-3 electrical card (DS1-14, DS3N-12E, DS3XM-6, DS3XM-12).                                                                                            |

**Table 2-7 Alarm Logical Object Type Definitions (continued)**

| Logical Object | Definition                                                                                                                                                                                                                                                                                                         |
|----------------|--------------------------------------------------------------------------------------------------------------------------------------------------------------------------------------------------------------------------------------------------------------------------------------------------------------------|
| DS3            | A DS-3 line on a DS3-12, DS3N-12, DS3-12E, DS3XM-6, DS3XM-12, DS3/EC1-48 card.                                                                                                                                                                                                                                     |
| E1             | An E1 line on a DS1/E1-56 card.                                                                                                                                                                                                                                                                                    |
| E1000F         | An E1000 Ethernet card (E1000-2, E1000-2G).                                                                                                                                                                                                                                                                        |
| E100T          | An E100 Ethernet card (E100T-12, E100T-G).                                                                                                                                                                                                                                                                         |
| EC1            | Any EC-1 port (including EC1-12 card ports).                                                                                                                                                                                                                                                                       |
| ENVALRM        | An environmental alarm port.                                                                                                                                                                                                                                                                                       |
| EQPT           | A card, its physical objects, and its logical objects as they are located in any of the eight noncommon card slots. The EQPT object is used for alarms that refer to the card itself and all other objects on the card including ports, lines, synchronous transport signals (STS), and virtual tributaries (VT).  |
| ESCON          | Enterprise System Connection fiber optic technology, referring to the following TXP cards: TXP_MR_2.5G, TXPP_MR_2.5G. For more information about ESCON alarms, refer to the “Alarm Troubleshooting” chapter in the <i>Cisco ONS 15454 DWDM Troubleshooting Guide</i> .                                             |
| EXT-SREF       | BITS outgoing references (SYNC-BITS1, SYNC-BITS2).                                                                                                                                                                                                                                                                 |
| FAN            | Fan-tray assembly.                                                                                                                                                                                                                                                                                                 |
| FC             | Fibre channel data transfer architecture, referring to the following muxponder (MXP) or TXP cards: MXP_MR_2.5G, MXPP_MR_2.5G, TXP_MR_2.5G, TXPP_MR_2.5G, TXP_MR_10E. For more information about FC alarms, refer to the “Alarm Troubleshooting” chapter in the <i>Cisco ONS 15454 DWDM Troubleshooting Guide</i> . |
| FCMR           | An FC_MR-4 Fibre Channel card.                                                                                                                                                                                                                                                                                     |
| FUDC           | SONET F1 byte user data channel for ONS 15454 ML-Series Ethernet cards.                                                                                                                                                                                                                                            |
| G1000          | A G-Series Ethernet card.                                                                                                                                                                                                                                                                                          |
| GE             | Gigabit Ethernet, referring to the following MXP or TXP cards: MXP_MR_2.5G, MXPP_MR_2.5G, TXP_MR_2.5G, TXPP_MR_2.5G, TXP_MR_10E, TXP_MR_10G.                                                                                                                                                                       |
| GFP-FAC        | Generic framing procedure facility port, referring to all MXP and TXP cards.                                                                                                                                                                                                                                       |
| ISC            | Inter-service channel, referring to TXPP_MR_2.5G or TXP_MR_2.5G cards. For more information about ISC alarms, refer to the “Alarm Troubleshooting” chapter in the <i>Cisco ONS 15454 DWDM Troubleshooting Guide</i> .                                                                                              |
| ML1000         | An ML1000 Ethernet card (ML1000-2).                                                                                                                                                                                                                                                                                |
| ML100T         | An ML100 Ethernet card (ML100T-12).                                                                                                                                                                                                                                                                                |
| MLFX           | An ML100X-8 Ethernet card.                                                                                                                                                                                                                                                                                         |
| MLMR           | An ML-MR-10 Ethernet card.                                                                                                                                                                                                                                                                                         |
| MSUDC          | Multiplex section user data channel.                                                                                                                                                                                                                                                                               |
| NE             | The entire network element.                                                                                                                                                                                                                                                                                        |
| NE-SREF        | The timing status of the NE.                                                                                                                                                                                                                                                                                       |

Table 2-7 Alarm Logical Object Type Definitions (continued)

| Logical Object | Definition                                                                                                                                                                                                                                                                                                                                                                                                                                                                                                                                                                              |
|----------------|-----------------------------------------------------------------------------------------------------------------------------------------------------------------------------------------------------------------------------------------------------------------------------------------------------------------------------------------------------------------------------------------------------------------------------------------------------------------------------------------------------------------------------------------------------------------------------------------|
| OCH            | The optical channel, referring to dense wavelength division multiplexing (DWDM) cards. For more information about OCH alarms, refer to the “Alarm Troubleshooting” chapter in the <i>Cisco ONS 15454 DWDM Troubleshooting Guide</i> .                                                                                                                                                                                                                                                                                                                                                   |
| OCHNC-CONN     | The optical channel network connection, referring to DWDM cards. For more information about OCHNC-CONN alarms, refer to the “Alarm Troubleshooting” chapter in the <i>Cisco ONS 15454 DWDM Troubleshooting Guide</i> .                                                                                                                                                                                                                                                                                                                                                                  |
| OCH-TERM       | The optical channel termination node, referring to DWDM cards. For more information about most of the alarms on this object, refer to the “Alarm Troubleshooting” chapter of the <i>Cisco ONS 15454 DWDM Troubleshooting Guide</i> .<br><br><b>Note</b> The network element reports alarms or conditions on ingress ports of the card. Alarms detected at the internal ports (TERM side) will be ingress mapped to the MON side. The alarm profile entities of OCH-TERM, if available, should be changed to the same severity as the customized severity for a specific OCH-TERM alarm. |
| OCN            | An OC-N line on any OC-N card.                                                                                                                                                                                                                                                                                                                                                                                                                                                                                                                                                          |
| OMS            | Optical multiplex section.                                                                                                                                                                                                                                                                                                                                                                                                                                                                                                                                                              |
| OSC-RING       | Optical service channel ring. For more information about OSC-RING alarms, refer to the “Alarm Troubleshooting” chapter in the <i>Cisco ONS 15454 DWDM Troubleshooting Guide</i> .                                                                                                                                                                                                                                                                                                                                                                                                       |
| OTS            | Optical transport section. For more information about OTS alarms, refer to the “Alarm Troubleshooting” chapter in the <i>Cisco ONS 15454 DWDM Troubleshooting Guide</i> .                                                                                                                                                                                                                                                                                                                                                                                                               |
| PPM            | Pluggable port module (PPM), referring to OC192-XFP, MXP, TXP, and MRC cards. For more information about PPM alarms, refer to the “Alarm Troubleshooting” chapter in the <i>Cisco ONS 15454 DWDM Troubleshooting Guide</i> .                                                                                                                                                                                                                                                                                                                                                            |
| PWR            | Power equipment.                                                                                                                                                                                                                                                                                                                                                                                                                                                                                                                                                                        |
| RPRIF          | Interface for Resilient Packet Ring technology as defined in IEEE 802.17b. Also called RPR-IEEE.                                                                                                                                                                                                                                                                                                                                                                                                                                                                                        |
| SHELF          | The shelf assembly. For more information about most of the alarms on this object, refer to the “Alarm Troubleshooting” chapter of the <i>Cisco ONS 15454 DWDM Troubleshooting Guide</i> .                                                                                                                                                                                                                                                                                                                                                                                               |
| STSMON         | STS alarm detection at the monitor point (upstream from the cross-connect).<br><br><b>Note</b> The network element reports alarms or conditions on ingress ports of the card. Alarms detected at the internal ports (TERM side) will be ingress mapped to the MON side. The alarm profile entities of STSMON, if available, should be changed to the same severity as the customized severity for a specific STS alarm.                                                                                                                                                                 |
| STSTRM         | STS alarm detection at termination (downstream from the cross-connect).<br><br><b>Note</b> The network element reports alarms or conditions on ingress ports of the card. Alarms detected at the internal ports (TERM side) will be ingress mapped to the MON side. The alarm profile entities of STSTRM, if available, should be changed to the same severity as the customized severity for a specific STS alarm.                                                                                                                                                                     |

Table 2-7 Alarm Logical Object Type Definitions (continued)

| Logical Object | Definition                                                                                                                                                                                                                                                                                                                                                                                                             |
|----------------|------------------------------------------------------------------------------------------------------------------------------------------------------------------------------------------------------------------------------------------------------------------------------------------------------------------------------------------------------------------------------------------------------------------------|
| TLINK          | Traffic engineering (TE) link correlation.                                                                                                                                                                                                                                                                                                                                                                             |
| TRUNK          | The optical or DWDM card carrying the high-speed signal; referring to MXP or TXP cards. For more information about TRUNK alarms, refer to the “Alarm Troubleshooting” chapter in the <i>Cisco ONS 15454 DWDM Troubleshooting Guide</i> .                                                                                                                                                                               |
| VCG            | A virtual concatenation group of VTs.                                                                                                                                                                                                                                                                                                                                                                                  |
| VT-MON         | VT1 alarm detection at the monitor point (upstream from the cross-connect).<br><br><b>Note</b> The network element reports alarms or conditions on ingress ports of the card. Alarms detected at the internal ports (TERM side) will be ingress mapped to the MON side. The alarm profile entities of VT-MON, if available, should be changed to the same severity as the customized severity for a specific VT alarm. |
| VT-TERM        | VT1 alarm detection at termination (downstream from the cross-connect).<br><br><b>Note</b> The network element reports alarms or conditions on ingress ports of the card. Alarms detected at the internal ports (TERM side) will be ingress mapped to the MON side. The alarm profile entities of VT-TERM, if available, should be changed to the same severity as the customized severity for a specific VT alarm.    |

## 2.4 Alarm List by Logical Object Type

Table 2-8 lists all ONS 15454 alarms and logical objects as they are given in the system alarm profile. The list entries are organized by logical object name and then by alarm or condition name. Where appropriate, the alarm entries also contain troubleshooting procedures.

**Note**

In a mixed network containing different types of nodes (such as ONS 15310-CL, ONS 15454, and ONS 15600), the initially displayed alarm list in the Provisioning > Alarm Profiles > Alarm Profile Editor tab lists all conditions that are applicable to all nodes in the network. However, when you load the default severity profile from a node, only applicable alarms will display severity levels. Nonapplicable alarms can display “use default” or “unset.”

**Note**

In some cases this list does not follow alphabetical order, but it does reflect the order shown in CTC.

Table 2-8 Alarm List by Logical Object in Alarm Profile

|                          |                          |                           |
|--------------------------|--------------------------|---------------------------|
| 2R: ALS (NA)             | FC: FAILTOSW (NA)        | OCN: MANUAL-REQ-RING (NA) |
| 2R: AS-CMD (NA)          | FC: FC-DE-NES (MJ)       | OCN: MANUAL-REQ-SPAN (NA) |
| 2R: AS-MT (NA)           | FC: FC-NO-CREDITS (MJ)   | OCN: PRC-DUPID (MJ)       |
| 2R: FAILTOSW (NA)        | FC: FORCED-REQ-SPAN (NA) | OCN: RFI-L (NR)           |
| 2R: FORCED-REQ-SPAN (NA) | FC: GE-OOSYNC (CR)       | OCN: RING-ID-MIS (MJ)     |
| 2R: HI-LASERBIAS (MN)    | FC: HI-LASERBIAS (MN)    | OCN: RING-MISMATCH (MJ)   |

Table 2-8 Alarm List by Logical Object in Alarm Profile (continued)

|                             |                            |                            |
|-----------------------------|----------------------------|----------------------------|
| 2R: HI-RXPOWER (MN)         | FC: HI-RXPOWER (MN)        | OCN: RING-SW-EAST (NA)     |
| 2R: HI-TXPOWER (MN)         | FC: HI-TXPOWER (MN)        | OCN: RING-SW-WEST (NA)     |
| 2R: LO-RXPOWER (MN)         | FC: LO-RXPOWER (MN)        | OCN: SD-L (NA)             |
| 2R: LO-TXPOWER (MN)         | FC: LO-TXPOWER (MN)        | OCN: SF-L (NA)             |
| 2R: LOCKOUT-REQ (NA)        | FC: LOCKOUT-REQ (NA)       | OCN: SPAN-SW-EAST (NA)     |
| 2R: LOS (CR)                | FC: LPBKFACILITY (NA)      | OCN: SPAN-SW-WEST (NA)     |
| 2R: MANUAL-REQ-SPAN (NA)    | FC: LPBKTERMINAL (NA)      | OCN: SQUELCH (NA)          |
| 2R: SQUELCHED (NA)          | FC: MANUAL-REQ-SPAN (NA)   | OCN: SQUELCHED (NA)        |
| 2R: WKSWPR (NA)             | FC: OUT-OF-SYNC (MJ)       | OCN: SSM-DUS (NA)          |
| 2R: WTR (NA)                | FC: SIGLOSS (MJ)           | OCN: SSM-FAIL (MN)         |
| AICI-AEP: EQPT (CR)         | FC: SQUELCHED (NA)         | OCN: SSM-LNC (NA)          |
| AICI-AEP: MFGMEM (CR)       | FC: SYNCLOSS (MJ)          | OCN: SSM-OFF (NA)          |
| AICI-AIE: EQPT (CR)         | FC: WKSWPR (NA)            | OCN: SSM-PRC (NA)          |
| AICI-AIE: MFGMEM (CR)       | FC: WTR (NA)               | OCN: SSM-PRS (NA)          |
| AIP: INVMACADR (MJ)         | FCMR: AS-CMD (NA)          | OCN: SSM-RES (NA)          |
| AIP: MEA (CR)               | FCMR: AS-MT (NA)           | OCN: SSM-SDH-TN (NA)       |
| AIP: MFGMEM (CR)            | FCMR: FAPS (NA)            | OCN: SSM-SETS (NA)         |
| AOTS: ALS (NA)              | FCMR: FC-DE-NES (MJ)       | OCN: SSM-SMC (NA)          |
| AOTS: AMPLI-INIT (NA)       | FCMR: FC-NO-CREDITS (MJ)   | OCN: SSM-ST2 (NA)          |
| AOTS: APC-DISABLED (NA)     | FCMR: GFP-CSF (MJ)         | OCN: SSM-ST3 (NA)          |
| AOTS: APC-CORR-SKIPPED (MN) | FCMR: GFP-DE-MISMATCH (MJ) | OCN: SSM-ST3E (NA)         |
| AOTS: APC-OUT-OF-RANGE (MN) | FCMR: GFP-EX-MISMATCH (MJ) | OCN: SSM-ST4 (NA)          |
| AOTS: APC-WRONG-GAIN (NA)   | FCMR: GFP-LFD (MJ)         | OCN: SSM-STU (NA)          |
| AOTS: AS-CMD (NA)           | FCMR: GFP-NO-BUFFERS (MJ)  | OCN: SSM-TNC (NA)          |
| AOTS: AS-MT (NA)            | FCMR: GFP-UP-MISMATCH (MJ) | OCN: STS-SQUELCH-L (NA)    |
| AOTS: CASETEMP-DEG (MN)     | FCMR: LPBKFACILITY (NA)    | OCN: SYNC-FREQ (NA)        |
| AOTS: FIBERTEMP-DEG (MN)    | FCMR: LPBKTERMINAL (NA)    | OCN: TIM (CR)              |
| AOTS: GAIN-HDEG (MN)        | FCMR: PORT-MISMATCH (NA)   | OCN: TIM-MON (MN)          |
| AOTS: GAIN-HFAIL (CR)       | FCMR: SIGLOSS (MJ)         | OCN: TIM-S (CR)            |
| AOTS: GAIN-LDEG (MN)        | FCMR: SYNCLOSS (MJ)        | OCN: VT-SQUELCH-L (NA)     |
| AOTS: GAIN-LFAIL (CR)       | FCMR: TPTFAIL (MJ)         | OCN: WKSWPR (NA)           |
| AOTS: LASER-APR (NA)        | FUDC: AIS (NR)             | OCN: WTR (NA)              |
| AOTS: LASERBIAS-DEG (MN)    | FUDC: LOS (MN)             | OMS: APC-CORR-SKIPPED (MN) |
| AOTS: LASERBIAS-FAIL (MJ)   | G1000: AS-CMD (NA)         | OMS: APC-DISABLED (NA)     |
| AOTS: LASERTEMP-DEG (MN)    | G1000: AS-MT (NA)          | OMS: APC-OUT-OF-RANGE (MN) |
| AOTS: OPWR-HDEG (MN)        | G1000: CARLOSS (MJ)        | OMS: AS-CMD (NA)           |
| AOTS: OPWR-HFAIL (CR)       | G1000: LPBKFACILITY (NA)   | OMS: AS-MT (NA)            |

Table 2-8 Alarm List by Logical Object in Alarm Profile (continued)

|                       |                               |                              |
|-----------------------|-------------------------------|------------------------------|
| AOTS: OPWR-LDEG (MN)  | G1000: LPBKTERMINAL (NA)      | OMS: LOS-O (MN)              |
| AOTS: OPWR-LFAIL (CR) | G1000: TPTFAIL (MJ)           | OMS: LOS-P (CR)              |
| AOTS: OSRION (NA)     | GE: ALS (NA)                  | OMS: OPWR-HDEG (MN)          |
| AOTS: PARAM-MISM (NA) | GE: AS-CMD (NA)               | OMS: OPWR-HFAIL (CR)         |
| AOTS: VOA-HDEG (MN)   | GE: AS-MT (NA)                | OMS: OPWR-LDEG (MN)          |
| AOTS: VOA-HFAIL (CR)  | GE: CARLOSS (MJ)              | OMS: OPWR-LFAIL (CR)         |
| AOTS: VOA-LDEG (MN)   | GE: FAILTOSW (NA)             | OMS: PARAM-MISM (NA)         |
| AOTS: VOA-LFAIL (CR)  | GE: FORCED-REQ-SPAN (NA)      | OMS: PMI (NA)                |
| BIC: MEA (CR)         | GE: GE-OOSYNC (CR)            | OMS: VOA-HDEG (MN)           |
| BITS: AIS (NR)        | GE: HI-LASERBIAS (MN)         | OMS: VOA-HFAIL (CR)          |
| BITS: BPV (MN)        | GE: HI-RXPOWER (MN)           | OMS: VOA-LDEG (MN)           |
| BITS: HI-CCVOLT (NA)  | GE: HI-TXPOWER (MN)           | OMS: VOA-LFAIL (CR)          |
| BITS: LOF (MN)        | GE: LMP-FAIL (MN)             | OSC-RING: RING-ID-MIS (MJ)   |
| BITS: LOS (MN)        | GE: LMP-SD (MN)               | OTS: APC-CORR-SKIPPED (MN)   |
| BITS: SSM-DUS (NA)    | GE: LMP-SF (MN)               | OTS: APC-DISABLED (NA)       |
| BITS: SSM-FAIL (MN)   | GE: LMP-UNALLOC (NA)          | OTS: APC-OUT-OF-RANGE (MN)   |
| BITS: SSM-LNC (NA)    | GE: LO-RXPOWER (MN)           | OTS: AS-CMD (NA)             |
| BITS: SSM-OFF (NA)    | GE: LO-TXPOWER (MN)           | OTS: AS-MT (NA)              |
| BITS: SSM-PRC (NA)    | GE: LOCKOUT-REQ (NA)          | OTS: AWG-DEG (MN)            |
| BITS: SSM-PRS (NA)    | GE: LPBKFACILITY (NA)         | OTS: AWG-FAIL (CR)           |
| BITS: SSM-RES (NA)    | GE: LPBKTERMINAL (NA)         | OTS: AWG-OVERTEMP (CR)       |
| BITS: SSM-SDH-TN (NA) | GE: MANUAL-REQ-SPAN (NA)      | OTS: AWG-WARM-UP (NA)        |
| BITS: SSM-SETS (NA)   | GE: OUT-OF-SYNC (MJ)          | OTS: DCU-LOSS-FAIL (MN)      |
| BITS: SSM-SMC (NA)    | GE: SIGLOSS (MJ)              | OTS: LASERBIAS-DEG (MN)      |
| BITS: SSM-ST2 (NA)    | GE: SQUELCHED (NA)            | OTS: LOS (CR)                |
| BITS: SSM-ST3 (NA)    | GE: SYNCLOSS (MJ)             | OTS: LOS-O (MN)              |
| BITS: SSM-ST3E (NA)   | GE: WKSWPR (NA)               | OTS: LOS-P (CR)              |
| BITS: SSM-ST4 (NA)    | GE: WTR (NA)                  | OTS: MT-OCHNC (NA)           |
| BITS: SSM-STU (NA)    | GFP-FAC: AS-CMD (NA)          | OTS: OPWR-HDEG (MN)          |
| BITS: SSM-TNC (NA)    | GFP-FAC: AS-MT (NA)           | OTS: OPWR-HFAIL (CR)         |
| BITS: SYNC-FREQ (NA)  | GFP-FAC: GFP-CSF (MJ)         | OTS: OPWR-LDEG (MN)          |
| BPLANE: AS-CMD (NA)   | GFP-FAC: GFP-DE-MISMATCH (MJ) | OTS: OPWR-LFAIL (CR)         |
| BPLANE: MFGMEM (CR)   | GFP-FAC: GFP-EX-MISMATCH (MJ) | OTS: OSRION (NA)             |
| CE1000: AS-CMD (NA)   | GFP-FAC: GFP-LFD (MJ)         | OTS: PARAM-MISM (NA)         |
| CE1000: AS-MT (NA)    | GFP-FAC: GFP-NO-BUFFERS (MJ)  | OTS: PMI (NA)                |
| CE1000: CARLOSS (MJ)  | GFP-FAC: GFP-UP-MISMATCH (MJ) | OTS: SH-IL-VAR-DEG-HIGH (MN) |
| CE1000: GFP-CSF (MJ)  | ISC: ALS (NA)                 | OTS: SH-IL-VAR-DEG-LOW (MN)  |

Table 2-8 Alarm List by Logical Object in Alarm Profile (continued)

|                              |                              |                                  |
|------------------------------|------------------------------|----------------------------------|
| CE1000: GFP-EX-MISMATCH (MJ) | ISC: AS-CMD (NA)             | OTS: SHUTTER-OPEN (NA)           |
| CE1000: GFP-LFD (MJ)         | ISC: AS-MT (NA)              | OTS: SPAN-NOT-MEASURED (NA)      |
| CE1000: GFP-UP-MISMATCH (MJ) | ISC: CARLOSS (MJ)            | OTS: SPANLEN-OUT-OF-RANGE (MN)   |
| CE1000: LPBKFACILITY (NA)    | ISC: FAILTOSW (NA)           | OTS: VOA-HDEG (MN)               |
| CE1000: LPBKTERMINAL (NA)    | ISC: FORCED-REQ-SPAN (NA)    | OTS: VOA-HFAIL (CR)              |
| CE1000: TPTFAIL (MJ)         | ISC: GE-OOSYNC (CR)          | OTS: VOA-LDEG (MN)               |
| CE100T: AS-CMD (NA)          | ISC: HI-LASERBIAS (MN)       | OTS: VOA-LFAIL (CR)              |
| CE100T: AS-MT (NA)           | ISC: HI-RXPOWER (MN)         | PPM: AS-CMD (NA)                 |
| CE100T: CARLOSS (MJ)         | ISC: HI-TXPOWER (MN)         | PPM: AS-MT (NA)                  |
| CE100T: DATA-CRC (MJ)        | ISC: LO-RXPOWER (MN)         | PPM: EQPT (CR)                   |
| CE100T: GFP-CSF (MJ)         | ISC: LO-TXPOWER (MN)         | PPM: HI-LASERBIAS (MN)           |
| CE100T: GFP-LFD (MJ)         | ISC: LOCKOUT-REQ (NA)        | PPM: HI-LASERTEMP (MN)           |
| CE100T: GFP-UP-MISMATCH (MJ) | ISC: LOS (CR)                | PPM: HI-TXPOWER (MN)             |
| CE100T: LPBKFACILITY (NA)    | ISC: LPBKFACILITY (NA)       | PPM: IMPROPRMVL (CR)             |
| CE100T: LPBKTERMINAL (NA)    | ISC: LPBKTERMINAL (NA)       | PPM: LO-LASERBIAS (MN)           |
| CE100T: TPTFAIL (MJ)         | ISC: MANUAL-REQ-SPAN (NA)    | PPM: LO-LASERTEMP (MN)           |
| CEMR: AS-CMD (NA)            | ISC: OUT-OF-SYNC (NA)        | PPM: LO-TXPOWER (MN)             |
| CEMR: AS-MT (NA)             | ISC: SIGLOSS (MJ)            | PPM: MEA (CR)                    |
| CEMR: CARLOSS (MJ)           | ISC: SQUELCHED (NA)          | PPM: MFGMEM (CR)                 |
| CEMR: GFP-CSF (MJ)           | ISC: SYNCLOSS (MJ)           | PPM: NON-CISCO-PPM (MN)          |
| CEMR: GFP-LFD (MJ)           | ISC: WKSWPR (NA)             | PPM: PROV-MISMATCH (MN)          |
| CEMR: GFP-UP-MISMATCH (MJ)   | ISC: WTR (NA)                | PPM: UNQUAL-PPM (MN)             |
| CEMR: LPBKFACILITY (NA)      | ML1000: AS-CMD (NA)          | PWR: AS-CMD (NA)                 |
| CEMR: LPBKTERMINAL (NA)      | ML1000: AS-MT (NA)           | PWR: BAT-FAIL (MJ)               |
| CEMR: PORT-MISMATCH (MJ)     | ML1000: AUTONEG-RFI (MJ)     | PWR: EHBATVVG (MJ)               |
| CEMR: TPTFAIL (MJ)           | ML1000: CARLOSS (MJ)         | PWR: ELWBATVVG (MJ)              |
| CTRL: LMP-FAIL (MN)          | ML1000: DATA-CRC (MJ)        | PWR: HIBATVVG (MJ)               |
| DS1: AIS (NR)                | ML1000: FORCED-REQ (NA)      | PWR: LWBATVVG (MJ)               |
| DS1: AS-CMD (NA)             | ML1000: GFP-CSF (MJ)         | PWR: VOLT-MISM (NA)              |
| DS1: AS-MT (NA)              | ML1000: GFP-LFD (MJ)         | RPRIF: MAX-STATIONS (MJ)         |
| DS1: IDLE (NA)               | ML1000: GFP-UP-MISMATCH (MJ) | RPRIF: RSV-RT-EXCD-RINGLET0 (MJ) |
| DS1: LOF (MJ)                | ML1000: LINK-KEEPALIVE (CR)  | RPRIF: RSV-RT-EXCD-RINGLET1 (MJ) |
| DS1: LOS (MJ)                | ML1000: MAN-REQ (NA)         | RPRIF: RPR-PASSTHR (NA)          |
| DS1: LPBKDS1FE-CMD (NA)      | ML1000: RPR-SD (NA)          | RPRIF: RPR-PEER-MISS (MJ)        |
| DS1: LPBKFACILITY (NA)       | ML1000: RPR-SF (NA)          | RPRIF: RPR-PROT-ACTIVE (NA)      |



Table 2-8 Alarm List by Logical Object in Alarm Profile (continued)

|                          |                                |                                  |
|--------------------------|--------------------------------|----------------------------------|
| DS1: LPBKTERMINAL (NA)   | ML1000: RPR-SPAN-MISMATCH (MJ) | RPRIF: RPR-PROT-CONFIG-MISM (MJ) |
| DS1: RAI (NA)            | ML1000: RPRW (NA)              | RPRIF: RPR-RI-FAIL (MJ)          |
| DS1: RCVR-MISS (MJ)      | ML1000: TPTFAIL (MJ)           | SHELF: APC-DISABLED (NA)         |
| DS1: SD (NA)             | ML1000: WTR (NA)               | SHELF: AS-CMD (NA)               |
| DS1: SF (NA)             | ML100T: AS-CMD (NA)            | SHELF: AS-MT (NA)                |
| DS1: SSM-DUS (NA)        | ML100T: AS-MT (NA)             | SHELF: DUP-SHELF-ID (MJ)         |
| DS1: SSM-FAIL (MN)       | ML100T: CARLOSS (MJ)           | SHELF: MEA (MJ)                  |
| DS1: SSM-OFF (NA)        | ML100T: DATA-CRC (MJ)          | SHELF: SHELF-COMM-FAIL (MJ)      |
| DS1: SSM-PRS (NA)        | ML100T: FORCED-REQ (NA)        | STSMON: AIS-P (NR)               |
| DS1: SSM-RES (NA)        | ML100T: GFP-CSF (MJ)           | STSMON: AUTOSW-AIS (NR)          |
| DS1: SSM-SMC (NA)        | ML100T: GFP-LFD (MJ)           | STSMON: AUTOSW-LOP (NA)          |
| DS1: SSM-ST2 (NA)        | ML100T: GFP-UP-MISMATCH (MJ)   | STSMON: AUTOSW-PDI (NA)          |
| DS1: SSM-ST3 (NA)        | ML100T: LINK-KEEPALIVE (CR)    | STSMON: AUTOSW-SDBER (NA)        |
| DS1: SSM-ST3E (NA)       | ML100T: MAN-REQ (NA)           | STSMON: AUTOSW-SFBER (NA)        |
| DS1: SSM-ST4 (NA)        | ML100T: RPR-SD (NA)            | STSMON: AUTOSW-UNEQ (NA)         |
| DS1: SSM-STU (NA)        | ML100T: RPR-SF (NA)            | STSMON: ERFI-P-CONN (NR)         |
| DS1: SYNC-FREQ (NA)      | ML100T: RPR-SPAN-MISMATCH (MJ) | STSMON: ERFI-P-PAYLD (NR)        |
| DS1: TRMT (MJ)           | ML100T: RPRW (NA)              | STSMON: ERFI-P-SRVR (NR)         |
| DS1: TRMT-MISS (MJ)      | ML100T: TPTFAIL (MJ)           | STSMON: FAILTOSW-PATH (NA)       |
| DS1: TX-AIS (NR)         | ML100T: WTR (NA)               | STSMON: FORCED-REQ (NA)          |
| DS1: TX-IDLE (NA)        | MLFX: AS-CMD (NA)              | STSMON: LOCKOUT-REQ (NA)         |
| DS1: TX-LOF (NR)         | MLFX: AS-MT (NA)               | STSMON: LOM (CR)                 |
| DS1: TX-RAI (NA)         | MLFX: CARLOSS (MJ)             | STSMON: LOP-P (CR)               |
| DS3: AIS (NR)            | MLFX: DATA-CRC (MJ)            | STSMON: LPBKCRS (NA)             |
| DS3: AS-CMD (NA)         | MLFX: FORCED-REQ (NA)          | STSMON: MAN-REQ (NA)             |
| DS3: AS-MT (NA)          | MLFX: GFP-CSF (MJ)             | STSMON: PDI-P (NA)               |
| DS3: DS3-MISM (NA)       | MLFX: GFP-LFD (MJ)             | STSMON: PLM-P (CR)               |
| DS3: FE-AIS (NA)         | MLFX: GFP-UP-MISMATCH (MJ)     | STSMON: RFI-P (NR)               |
| DS3: FE-DS1-MULTLOS (NA) | MLFX: LINK-KEEPALIVE (CR)      | STSMON: ROLL (NA)                |
| DS3: FE-DS1-NSA (NA)     | MLFX: MAN-REQ (NA)             | STSMON: ROLL-PEND (NA)           |
| DS3: FE-DS1-SA (NA)      | MLFX: RPR-SD (NA)              | STSMON: SD-P (NA)                |
| DS3: FE-DS1-SNGLLOS (NA) | MLFX: RPR-SF (NA)              | STSMON: SF-P (NA)                |
| DS3: FE-DS3-NSA (NA)     | MLFX: RPR-SPAN-MISMATCH (MJ)   | STSMON: TIM-P (MN)               |
| DS3: FE-DS3-SA (NA)      | MLFX: RPRW (NA)                | STSMON: UNEQ-P (CR)              |
| DS3: FE-EQPT-NSA (NA)    | MLFX: TPTFAIL (MJ)             | STSMON: WKSWPR (NA)              |
| DS3: FE-IDLE (NA)        | MLFX: WTR (NA)                 | STSMON: WTR (NA)                 |

Table 2-8 Alarm List by Logical Object in Alarm Profile (continued)

|                           |                              |                               |
|---------------------------|------------------------------|-------------------------------|
| DS3: FE-LOF (NA)          | MLMR: AS-CMD (NA)            | STSTRM: AIS-P (NR)            |
| DS3: FE-LOS (NA)          | MLMR: AS-MT (NA)             | STSTRM: AS-MT-OOG (NA)        |
| DS3: INC-ISD (NA)         | MLMR: CARLOSS (MJ)           | STSTRM: ENCAP-MISMATCH-P (CR) |
| DS3: LOF (CR)             | MLMR: FORCED-REQ (NA)        | STSTRM: ERFI-P-CONN (NR)      |
| DS3: LOS (CR)             | MLMR: GFP-CSF (MJ)           | STSTRM: ERFI-P-PAYLD (NR)     |
| DS3: LPBKDS3FEAC (NA)     | MLMR: GFP-LFD (MJ)           | STSTRM: ERFI-P-SRVR (NR)      |
| DS3: LPBKDS3FEAC-CMD (NA) | MLMR: GFP-UP-MISMATCH (MJ)   | STSTRM: LCAS-CRC (NA)         |
| DS3: LPBKFACILITY (NA)    | MLMR: LINK-KEEPALIVE (CR)    | STSTRM: LCAS-RX-DNU (NA)      |
| DS3: LPBKTERMINAL (NA)    | MLMR: LPBKFACILITY (NA)      | STSTRM: LCAS-RX-FAIL (NA)     |
| DS3: RAI (NA)             | MLMR: LPBKTERMINAL (NA)      | STSTRM: LCAS-RX-GRP-ERR (NA)  |
| DS3: SD (NA)              | MLMR: MAN-REQ (NA)           | STSTRM: LCAS-TX-ADD (NA)      |
| DS3: SF (NA)              | MLMR: PORT-MISMATCH (MJ)     | STSTRM: LCAS-TX-DNU (NA)      |
| DS3: TX-AIS (NR)          | MLMR: RPR-SD (NA)            | STSTRM: LOF (CR)              |
| DS3: TX-RAI (NA)          | MLMR: RPR-SF (NA)            | STSTRM: LOM (CR)              |
| E1000F: AS-CMD (NA)       | MLMR: RPR-SPAN-MISMATCH (MJ) | STSTRM: LOP-P (CR)            |
| E1000F: CARLOSS (MJ)      | MLMR: TPTFAIL (MJ)           | STSTRM: LPBKCRS (NA)          |
| E100T: AS-CMD (NA)        | MLMR: WTR (NA)               | STSTRM: OOU-TPT (NA)          |
| E100T: CARLOSS (MJ)       | MSUDC: AIS (NR)              | STSTRM: PDI-P (NA)            |
| E1: AIS (NR)              | MSUDC: LOS (MN)              | STSTRM: PLM-P (CR)            |
| E1: AS-CMD (NA)           | NE-SREF: FRCDSWTOINT (NA)    | STSTRM: RFI-P (NR)            |
| E1: AS-MT (NA)            | NE-SREF: FRCDSWTOPRI (NA)    | STSTRM: ROLL (NA)             |
| E1: LOF (MJ)              | NE-SREF: FRCDSWTOSEC (NA)    | STSTRM: ROLL-PEND (NR)        |
| E1: LOS (MJ)              | NE-SREF: FRCDSWTOHIRD (NA)   | STSTRM: SD-P (NA)             |
| E1: LPBKFACILITY (NA)     | NE-SREF: FRNGSYNC (NA)       | STSTRM: SF-P (NA)             |
| E1: LPBKTERMINAL (NA)     | NE-SREF: FSTSYNC (NA)        | STSTRM: SQM (CR)              |
| E1: MS-DEG (NA)           | NE-SREF: HLDOVRSYNC (NA)     | STSTRM: TIM-P (CR)            |
| E1: MS-EXC (NA)           | NE-SREF: MANSWTOINT (NA)     | STSTRM: UNEQ-P (CR)           |
| E1: RAI (NA)              | NE-SREF: MANSWTOPRI (NA)     | TLINK: LMP-FAIL (MN)          |
| E1: RCVR-MISS (MJ)        | NE-SREF: MANSWTOSEC (NA)     | TRUNK: AIS (NR)               |
| E1: SSM-DUS (NA)          | NE-SREF: MANSWTOHIRD (NA)    | TRUNK: AIS-L (NR)             |
| E1: SSM-FAIL (MN)         | NE-SREF: SSM-LNC (NA)        | TRUNK: ALS (NA)               |
| E1: SSM-OFF (NA)          | NE-SREF: SSM-PRC (NA)        | TRUNK: AS-CMD (NA)            |
| E1: SSM-PRS (NA)          | NE-SREF: SSM-PRS (NA)        | TRUNK: AS-MT (NA)             |
| E1: SSM-RES (NA)          | NE-SREF: SSM-RES (NA)        | TRUNK: CARLOSS (MJ)           |
| E1: SSM-SMC (NA)          | NE-SREF: SSM-SDH-TN (NA)     | TRUNK: DSP-COMM-FAIL (MJ)     |
| E1: SSM-ST2 (NA)          | NE-SREF: SSM-SETS (NA)       | TRUNK: DSP-FAIL (MJ)          |
| E1: SSM-ST3 (NA)          | NE-SREF: SSM-SMC (NA)        | TRUNK: EOC (MN)               |

**Table 2-8 Alarm List by Logical Object in Alarm Profile (continued)**

|                              |                            |                             |
|------------------------------|----------------------------|-----------------------------|
| E1: SSM-ST3E (NA)            | NE-SREF: SSM-ST2 (NA)      | TRUNK: EOC-L (MN)           |
| E1: SSM-ST4 (NA)             | NE-SREF: SSM-ST3 (NA)      | TRUNK: FAILTOSW (NA)        |
| E1: SSM-STU (NA)             | NE-SREF: SSM-ST3E (NA)     | TRUNK: FAPS (NA)            |
| E1: SYNC-FREQ (NA)           | NE-SREF: SSM-ST4 (NA)      | TRUNK: FC-DE-NES (MJ)       |
| E1: TRMT (MJ)                | NE-SREF: SSM-STU (NA)      | TRUNK: FC-NO-CREDITS (MJ)   |
| E1: TRMT-MISS (MJ)           | NE-SREF: SSM-TNC (NA)      | TRUNK: FEC-MISM (MJ)        |
| E1: TX-AIS (NR)              | NE-SREF: SWTOPRI (NA)      | TRUNK: FORCED-REQ-SPAN (NA) |
| E1: TX-LOF (NR)              | NE-SREF: SWTOSEC (NA)      | TRUNK: GCC-EOC (MN)         |
| E1: TX-RAI (NA)              | NE-SREF: SWTOTHIRD (NA)    | TRUNK: GE-OOSYNC (CR)       |
| EC1: AIS-L (NR)              | NE-SREF: SYNCPRI (MJ)      | TRUNK: HELLO (MN)           |
| EC1: AS-CMD (NA)             | NE-SREF: SYNCSEC (MN)      | TRUNK: HI-LASERBIAS (MN)    |
| EC1: AS-MT (NA)              | NE-SREF: SYNCTHIRD (MN)    | TRUNK: HI-RXPOWER (MN)      |
| EC1: FE-FRCDWKSWPR-RING (NA) | NE: APC-DISABLED (NA)      | TRUNK: HI-TXPOWER (MN)      |
| EC1: FE-MANWKSWPR-RING (NA)  | NE: APC-DISABLED (NA)      | TRUNK: ILK-FAIL (CR)        |
| EC1: FORCED-REQ-SPAN (NA)    | NE: APC-END (NA)           | TRUNK: ISIS-ADJ-FAIL (MN)   |
| EC1: LOF (CR)                | NE: AS-CMD (NA)            | TRUNK: LO-RXPOWER (MN)      |
| EC1: LOS (CR)                | NE: AUD-LOG-LOSS (NA)      | TRUNK: LO-TXPOWER (MN)      |
| EC1: LPBKFACILITY (NA)       | NE: AUD-LOG-LOW (NA)       | TRUNK: LOCKOUT-REQ (NA)     |
| EC1: LPBKTERMINAL (NA)       | NE: DATAFLT (MN)           | TRUNK: LOF (CR)             |
| EC1: MANUAL-REQ-SPAN (NA)    | NE: DBOSYNC (MJ)           | TRUNK: LOM (CR)             |
| EC1: RFI-L (NR)              | NE: DUP-IPADDR (MN)        | TRUNK: LOS (CR)             |
| EC1: SD-L (NA)               | NE: DUP-NODENAME (MN)      | TRUNK: LOS-P (CR)           |
| EC1: SF-L (NA)               | NE: ETH-LINKLOSS (NA)      | TRUNK: LPBKFACILITY (NA)    |
| EC1: TIM-S (CR)              | NE: HITEMP (CR)            | TRUNK: LPBKTERMINAL (NA)    |
| EC1: WTR (NA)                | NE: I-HITEMP (CR)          | TRUNK: MANUAL-REQ-SPAN (NA) |
| ENVALRM: EXT (MN)            | NE: INTRUSION-PSWD (NA)    | TRUNK: ODUK-1-AIS-PM (NR)   |
| EQPT: ALS-DISABLED (NA)      | NE: LAN-POL-REV (NA)       | TRUNK: ODUK-2-AIS-PM (NR)   |
| EQPT: APC-DISABLED (NA)      | NE: SNTP-HOST (MN)         | TRUNK: ODUK-3-AIS-PM (NR)   |
| EQPT: AS-CMD (NA)            | NE: SYSBOOT (MJ)           | TRUNK: ODUK-4-AIS-PM (NR)   |
| EQPT: AS-MT (NA)             | NE: TEMP-MISM (NA)         | TRUNK: ODUK-AIS-PM (NR)     |
| EQPT: AUTORESET (MN)         | OCH-TERM: FDI (NA)         | TRUNK: ODUK-BDI-PM (NR)     |
| EQPT: BKUPMEMP (CR)          | OCH-TERM: OCHTERM-INC (NA) | TRUNK: ODUK-LCK-PM (NR)     |
| EQPT: CARLOSS (MJ)           | OCH-TERM: OPWR-HDEG (MN)   | TRUNK: ODUK-OCI-PM (NR)     |
| EQPT: CLDRESTART (NA)        | OCH-TERM: OPWR-LDEG (MN)   | TRUNK: ODUK-SD-PM (NA)      |
| EQPT: COMIOXC (CR)           | OCH-TERM: OPWR-LFAIL (CR)  | TRUNK: ODUK-SF-PM (NA)      |
| EQPT: COMM-FAIL (MN)         | OCH-TERM: PARAM-MISM (NA)  | TRUNK: ODUK-TIM-PM (MJ)     |
| EQPT: CONTBUS-A-18 (MN)      | —                          | TRUNK: OTUK-AIS (NR)        |

Table 2-8 Alarm List by Logical Object in Alarm Profile (continued)

|                                 |                             |                           |
|---------------------------------|-----------------------------|---------------------------|
| EQPT: CONTBUS-B-18 (MN)         | —                           | TRUNK: OTUK-BDI (NR)      |
| EQPT: CONTBUS-DISABLED (CR)     | —                           | TRUNK: OTUK-IAE (MN)      |
| EQPT: CONTBUS-IO-A (MN)         | —                           | TRUNK: OTUK-LOF (CR)      |
| EQPT: CONTBUS-IO-B (MN)         | OCH: APC-CORR-SKIPPED (MN)  | TRUNK: OTUK-SD (NA)       |
| EQPT: CPP-INCAPABLE (NA)        | OCH: APC-DISABLED (NA)      | TRUNK: OTUK-SF (NA)       |
| EQPT: CTNEQPT-MISMATCH (NA)     | OCH: APC-OUT-OF-RANGE (MN)  | TRUNK: OTUK-TIM (CR)      |
| EQPT: CTNEQPT-PBPROT (CR)       | OCH: AS-CMD (NA)            | TRUNK: OUT-OF-SYNC (MJ)   |
| EQPT: CTNEQPT-PBWORK (CR)       | OCH: AS-MT (NA)             | TRUNK: PROV-MISMATCH (MJ) |
| EQPT: EQPT (CR)                 | OCH: FDI (NA)               | TRUNK: PTIM (MJ)          |
| EQPT: EQPT-DIAG (CR)            | OCH: LOS-O (MN)             | TRUNK: RFI (NR)           |
| EQPT: ERROR-CONFIG (MN)         | OCH: LOS-P (CR)             | TRUNK: RFI-L (NR)         |
| EQPT: EXCCOL (MN)               | OCH: OPWR-HDEG (MN)         | TRUNK: SD (NA)            |
| EQPT: FAILTOSW (NA)             | OCH: OPWR-HFAIL (CR)        | TRUNK: SD-L (NA)          |
| EQPT: FAPS-CONFIG-MISMATCH (MN) | OCH: OPWR-LDEG (MN)         | TRUNK: SF (NA)            |
| EQPT: FORCED-REQ (NA)           | OCH: OPWR-LFAIL (CR)        | TRUNK: SF-L (NA)          |
| EQPT: FP-LINK-LOSS (MN)         | OCH: PARAM-MISM (NA)        | TRUNK: SIGLOSS (MJ)       |
| EQPT: FTA-MISMATCH (NA)         | OCH: PORT-FAIL (CR)         | TRUNK: SQUELCHED (NA)     |
| EQPT: HI-LASERBIAS (MN)         | OCH: TRAIL-SIGNAL-FAIL (NA) | TRUNK: SSM-DUS (NA)       |
| EQPT: HI-LASERTEMP (MN)         | OCH: VOA-HDEG (MN)          | TRUNK: SSM-FAIL (MN)      |
| EQPT: HI-TXPOWER (MN)           | OCH: VOA-HFAIL (CR)         | TRUNK: SSM-LNC (NA)       |
| EQPT: HITEMP (MN)               | OCH: VOA-LDEG (MN)          | TRUNK: SSM-OFF (NA)       |
| EQPT: IMPROPRMVL (CR)           | OCH: VOA-LFAIL (CR)         | TRUNK: SSM-PRC (NA)       |
| EQPT: INHSWPR (NA)              | OCHNC-CONN: OCHNC-INC (NA)  | TRUNK: SSM-PRS (NA)       |
| EQPT: INHSWWKG (NA)             | OCN: AIS-L (NR)             | TRUNK: SSM-RES (NA)       |
| EQPT: IOSCFGCOPY (NA)           | OCN: ALS (NA)               | TRUNK: SSM-SDH-TN (NA)    |
| EQPT: LO-LASERBIAS (MN)         | OCN: APS-INV-PRIM (MN)      | TRUNK: SSM-SETS (NA)      |
| EQPT: LO-LASERTEMP (MN)         | OCN: APS-PRIM-FAC (NA)      | TRUNK: SSM-SMC (NA)       |
| EQPT: LO-TXPOWER (MN)           | OCN: APS-PRIM-SEC-MISM (MN) | TRUNK: SSM-ST2 (NA)       |
| EQPT: LOCKOUT-REQ (NA)          | OCN: APSB (MN)              | TRUNK: SSM-ST3 (NA)       |
| EQPT: MAN-REQ (NA)              | OCN: APSC-IMP (MN)          | TRUNK: SSM-ST3E (NA)      |
| EQPT: MANRESET (NA)             | OCN: APSCDFLTK (MN)         | TRUNK: SSM-ST4 (NA)       |
| EQPT: MEA (CR)                  | OCN: APSCINCON (MN)         | TRUNK: SSM-STU (NA)       |
| EQPT: MEM-GONE (MJ)             | OCN: APSCM (MJ)             | TRUNK: SSM-TNC (NA)       |
| EQPT: MEM-LOW (MN)              | OCN: APSCNMIS (MJ)          | TRUNK: SYNC-FREQ (NA)     |
| EQPT: NO-CONFIG (NA)            | OCN: APSIMP (MN)            | TRUNK: SYNCLOSS (MJ)      |
| EQPT: OPEN-SLOT (NA)            | OCN: APSMM (MN)             | TRUNK: TIM (CR)           |

**Table 2-8 Alarm List by Logical Object in Alarm Profile (continued)**

|                               |                               |                               |
|-------------------------------|-------------------------------|-------------------------------|
| EQPT: PEER-NORESPONSE (MJ)    | OCN: AS-CMD (NA)              | TRUNK: TIM-MON (MN)           |
| EQPT: PROTNA (MN)             | OCN: AS-MT (NA)               | TRUNK: TRAIL-SIGNAL-FAIL (NA) |
| EQPT: PWR-FAIL-A (MN)         | OCN: AUTOLSROFF (CR)          | TRUNK: UNC-WORD (NA)          |
| EQPT: PWR-FAIL-B (MN)         | OCN: BLSR-SW-VER-MISM (MJ)    | TRUNK: UT-COMM-FAIL (MJ)      |
| EQPT: PWR-FAIL-RET-A (MN)     | OCN: BLSROSYNC (MJ)           | TRUNK: UT-FAIL (MJ)           |
| EQPT: PWR-FAIL-RET-B (MN)     | OCN: E-W-MISMATCH (MJ)        | TRUNK: WTR (NA)               |
| EQPT: RUNCFG-SAVENEED (NA)    | OCN: EOC (MN)                 | TRUNK: WVLMISMATCH (MJ)       |
| EQPT: SFTWDOWN (MN)           | OCN: EOC-L (MN)               | VCG: LOA (CR)                 |
| EQPT: SW-MISMATCH (NA)        | OCN: EXERCISE-RING-FAIL (NA)  | VCG: VCG-DEG (NA)             |
| EQPT: SWMTXMOD-PROT (CR)      | OCN: EXERCISE-SPAN-FAIL (NA)  | VCG: VCG-DOWN (NA)            |
| EQPT: SWMTXMOD-WORK (CR)      | OCN: EXTRA-TRAF-PREEMPT (MJ)  | VT-MON: AIS-V (NR)            |
| EQPT: WKSWPR (NA)             | OCN: FAILTOSW (NA)            | VT-MON: AUTOSW-AIS (NR)       |
| EQPT: WTR (NA)                | OCN: FAILTOSWR (NA)           | VT-MON: AUTOSW-LOP (NA)       |
| ESCON: ALS (NA)               | OCN: FAILTOSWS (NA)           | VT-MON: AUTOSW-PDI (NA)       |
| ESCON: AS-CMD (NA)            | OCN: FE-FRCDWKSWBK-SPAN (NA)  | VT-MON: AUTOSW-SDBER (NA)     |
| ESCON: AS-MT (NA)             | OCN: FE-FRCDWKSWPR-RING (NA)  | VT-MON: AUTOSW-SFBER (NA)     |
| ESCON: FAILTOSW (NA)          | OCN: FE-FRCDWKSWPR-SPAN (NA)  | VT-MON: AUTOSW-UNEQ (NA)      |
| ESCON: FORCED-REQ-SPAN (NA)   | OCN: FE-LOCKOUTOFPR-SPAN (NA) | VT-MON: FAILTOSW-PATH (NA)    |
| ESCON: HI-LASERBIAS (MN)      | OCN: FE-MANWKSWBK-SPAN (NA)   | VT-MON: FORCED-REQ (NA)       |
| ESCON: HI-RXPOWER (MN)        | OCN: FE-MANWKSWPR-RING (NA)   | VT-MON: LOCKOUT-REQ (NA)      |
| ESCON: HI-TXPOWER (MN)        | OCN: FE-MANWKSWPR-SPAN (NA)   | VT-MON: LOP-V (MJ)            |
| ESCON: LO-RXPOWER (MN)        | OCN: FE-SD-SPAN (NA)          | VT-MON: MAN-REQ (NA)          |
| ESCON: LO-TXPOWER (MN)        | OCN: FE-SDPRLF (MN)           | VT-MON: PLM-V (MJ)            |
| ESCON: LOCKOUT-REQ (NA)       | OCN: FE-SF-RING (NA)          | VT-MON: RFI-V (NR)            |
| ESCON: LOS (CR)               | OCN: FE-SF-SPAN (NA)          | VT-MON: ROLL (NA)             |
| ESCON: LPBKFACILITY (NA)      | OCN: FEPRLF (MN)              | VT-MON: ROLL-PEND (NA)        |
| ESCON: LPBKTERMINAL (NA)      | OCN: FORCED-REQ-RING (NA)     | VT-MON: SD-V (NA)             |
| ESCON: MANUAL-REQ-SPAN (NA)   | OCN: FORCED-REQ-SPAN (NA)     | VT-MON: SF-V (NA)             |
| ESCON: SIGLOSS (MJ)           | OCN: FULLPASSTHR-BI (NA)      | VT-MON: TIM-V (MJ)            |
| ESCON: SQUELCHED (NA)         | OCN: HELLO (MN)               | VT-MON: UNEQ-V (MJ)           |
| ESCON: WKSWPR (NA)            | OCN: HI-LASERBIAS (MN)        | VT-MON: WKSWPR (NA)           |
| ESCON: WTR (NA)               | OCN: HI-LASERTEMP (MN)        | VT-MON: WTR (NA)              |
| EXT-SREF: FRCDSWTOPRI (NA)    | OCN: HI-RXPOWER (MN)          | VT-TERM: AIS-V (NR)           |
| EXT-SREF: FRCDSWTOSEC (NA)    | OCN: HI-TXPOWER (MN)          | VT-TERM: AS-MT-OOG (NA)       |
| EXT-SREF: FRCDSWTOSECOND (NA) | OCN: ISIS-ADJ-FAIL (MN)       | VT-TERM: LCAS-CRC (NA)        |
| EXT-SREF: MANSWTOPRI (NA)     | OCN: KB-PASSTHR (NA)          | VT-TERM: LCAS-RX-DNU (NA)     |
| EXT-SREF: MANSWTOSEC (NA)     | OCN: KBYTE-APS-CHAN-FAIL (MN) | VT-TERM: LCAS-RX-FAIL (NA)    |

**Table 2-8 Alarm List by Logical Object in Alarm Profile (continued)**

|                            |                        |                               |
|----------------------------|------------------------|-------------------------------|
| EXT-SREF: MANSWTOHIRD (NA) | OCN: LASEREOL (MN)     | VT-TERM: LCAS-RX-GRP-ERR (NA) |
| EXT-SREF: SWTOPRI (NA)     | OCN: LKOUTPR-S (NA)    | VT-TERM: LCAS-TX-ADD (NA)     |
| EXT-SREF: SWTOSEC (NA)     | OCN: LMP-FAIL (MN)     | VT-TERM: LCAS-TX-DNU (NA)     |
| EXT-SREF: SWTOHIRD (NA)    | OCN: LMP-SD (MN)       | VT-TERM: LOM (MJ)             |
| EXT-SREF: SYNCPRI (MN)     | OCN: LMP-SF (MN)       | VT-TERM: LOP-V (MJ)           |
| EXT-SREF: SYNCSEC (MN)     | OCN: LMP-UNALLOC (NA)  | VT-TERM: OOU-TPT (NA)         |
| EXT-SREF: SYNCTHIRD (MN)   | OCN: LO-LASERBIAS (MN) | VT-TERM: PLM-V (MJ)           |
| FAN: EQPT-MISS (CR)        | OCN: LO-LASERTEMP (MN) | VT-TERM: RFI-V (NR)           |
| FAN: FAN (CR)              | OCN: LO-RXPOWER (MN)   | VT-TERM: ROLL (NA)            |
| FAN: MEA (CR)              | OCN: LO-TXPOWER (MN)   | VT-TERM: ROLL-PEND (NA)       |
| FAN: MFGMEM (CR)           | OCN: LOCKOUT-REQ (NA)  | VT-TERM: SD-V (NA)            |
| FC: ALS (NA)               | OCN: LOF (CR)          | VT-TERM: SF-V (NA)            |
| FC: AS-CMD (NA)            | OCN: LOS (CR)          | VT-TERM: SQM (MJ)             |
| FC: AS-MT (NA)             | OCN: LPBKFACILITY (NA) | VT-TERM: TIM-V (MJ)           |
| FC: CARLOSS (MJ)           | OCN: LPBKTERMINAL (NA) | VT-TERM: UNEQ-V (MJ)          |

## 2.5 Trouble Notifications

The ONS 15454 system reports trouble by utilizing standard alarm and condition characteristics, standard severities following the rules in Telcordia GR-253-CORE, and graphical user interface (GUI) state indicators. These notifications are described in the following paragraphs.

The ONS 15454 uses standard Telcordia categories to characterize levels of trouble. The system reports trouble notifications as alarms and status or descriptive notifications (if configured to do so) as conditions in the CTC Alarms window. Alarms typically signify a problem that the user needs to remedy, such as a loss of signal. Conditions do not necessarily require troubleshooting.

### 2.5.1 Alarm Characteristics

The ONS 15454 uses standard alarm entities to identify what is causing trouble. All alarms stem from hardware, software, environment, or operator-originated problems whether or not they affect service. Current alarms for the network, CTC session, node, or card are listed in the Alarms tab. (In addition, cleared alarms are also found in the History tab.)

### 2.5.2 Condition Characteristics

Conditions include any problem detected on an ONS 15454 shelf. They can include standing or transient notifications. A snapshot of all current raised, standing conditions on the network, node, or card can be retrieved in the CTC Conditions window or using TL1's set of RTRV-COND commands. (In addition, some but not all cleared conditions are also found in the History tab.)

For a comprehensive list of all conditions, refer to the *Cisco ONS SONET TLI Command Guide*. For more information about transient conditions, see [Chapter 3, "Transient Conditions."](#)

**Note**

When an entity is put in the OOS,MT administrative state, the ONS 15454 suppresses all standing alarms on that entity and alarms and events appear on the Conditions tab. You can change this behavior for the LPBKFACILITY and LPBKTERMINAL alarms. To display these alarms on the Alarms tab, set the NODE.general.ReportLoopbackConditionsOnOOS-MTPorts value to TRUE on the NE Defaults tab. For more information about changing NE defaults, refer to the “Maintain the Node” chapter in the *Cisco ONS 15454 Procedure Guide*.

## 2.5.3 Severities

The ONS 15454 uses Telcordia-devised standard severities for alarms and conditions: Critical (CR), Major (MJ), Minor (MN), Not Alarmed (NA) and Not Reported (NR). These are described below:

- A Critical (CR) alarm generally indicates severe, Service-Affecting (SA) trouble that needs immediate correction. Loss of traffic on an STS-1, which can hold 28 DS-1 circuits, would be a Critical (CR), Service-Affecting (SA) alarm.
- A Major (MJ) alarm is a serious alarm, but the trouble has less impact on the network. For example, loss of traffic on more than five DS-1 circuits is Critical (CR), but loss of traffic on one to four DS-1 circuits is Major (MJ).
- Minor (MN) alarms generally are those that do not affect service. For example, the automatic protection switching (APS) byte failure (APSB) alarm indicates that line terminating equipment (LTE) detects a byte failure on the signal that could prevent traffic from properly executing a traffic switch.
- Not Alarmed (NA) conditions are information indicators, such as for free-run synchronization state (FRNGSYNC) or a forced-switch to primary (FRCSWTOPRI) timing event. They could or could not require troubleshooting, as indicated in the entries.
- Not Reported (NR) conditions occur as a secondary result of another event. For example, the alarm indication signal (AIS), with severity NR, is inserted by a downstream node when an LOS (CR or MJ) alarm occurs upstream. These conditions do not in themselves require troubleshooting, but are to be expected in the presence of primary alarms.

Severities can be customized for an entire network or for single nodes, from the network level down to the port level by changing or downloading customized alarm profiles. These custom severities are subject to the standard severity-demoting rules given in Telcordia GR-474-CORE and shown in the “[2.5.4 Alarm Hierarchy](#)” section on page 2-33. Procedures for customizing alarm severities are located in the “Manage Alarms” chapter in the *Cisco ONS 15454 Procedure Guide*.

## 2.5.4 Alarm Hierarchy

All alarm, condition, and unreported event severities listed in this manual are default profile settings. However in situations when traffic is not lost, such as when the alarm occurs on protected ports or circuits, alarms having Critical (CR) or Major (MJ) default severities can be demoted to lower severities such as Minor (MN) or Non-Service-Affecting (NSA) as defined in Telcordia GR-474-CORE.

A path alarm can be demoted if a higher-ranking alarm is raised for the same object. For example, If a path trace identifier mismatch (TIM-P) is raised on a circuit path and then a loss of pointer on the path (LOP-P) is raised on the path, the LOP-P alarm stands and the TIM-P closes. The path alarm hierarchy used in the ONS 15454 system is shown in [Table 2-9](#).

**Table 2-9 Path Alarm Hierarchy**

| Priority | Condition Type |
|----------|----------------|
| Highest  | AIS-P          |
| —        | LOP-P          |
| —        | UNEQ-P         |
| Lowest   | TIM-P          |

Facility (port) alarms also follow a hierarchy, which means that lower-ranking alarms are closed by higher-ranking alarms. The facility alarm hierarchy used in the ONS 15454 is shown in [Table 2-10](#).

**Table 2-10 Facility Alarm Hierarchy**

| Priority | Condition Type |
|----------|----------------|
| Highest  | LOS            |
| —        | LOF            |
| —        | AIS-L          |
| —        | SF-L           |
| —        | SD-L           |
| —        | RFI-L          |
| —        | TIM-S          |
| —        | AIS-P          |
| —        | LOP-P          |
| —        | SF-P           |
| —        | SD-P           |
| —        | UNEQ-P         |
| —        | TIM-P          |
| Lowest   | PLM-P          |

Near-end failures and far-end failures follow different hierarchies. Near-end failures stand according to whether they are for the entire signal (LOS, LOF), facility (AIS-L), path (AIS-P, etc.) or VT (AIS-V, etc.). The full hierarchy for near-end failures is shown in [Table 2-11](#). This table is taken from Telcordia GR-253-CORE.

**Table 2-11 Near-End Alarm Hierarchy**

| Priority | Condition Type     |
|----------|--------------------|
| Highest  | LOS                |
| —        | LOF                |
| —        | AIS-L              |
| —        | AIS-P <sup>1</sup> |
| —        | LOP-P <sup>2</sup> |



**Table 2-11** *Near-End Alarm Hierarchy*

| Priority | Condition Type                                   |
|----------|--------------------------------------------------|
| —        | UNEQ-P                                           |
| —        | TIM-P                                            |
| —        | PLM-P                                            |
| —        | AIS-V <sup>1</sup>                               |
| —        | LOP-V <sup>2</sup>                               |
| —        | UNEQ-V                                           |
| —        | PLM-V                                            |
| Lowest   | DS-N AIS (if reported for outgoing DS-N signals) |

1. Although it is not defined as a defect or failure, all-ones STS pointer relay is also higher priority than LOP-P. Similarly, all-ones VT pointer relay is higher priority than LOP-V.
2. LOP-P is also higher priority than the far-end failure RFI-P, which does not affect the detection of any near-end failures. Similarly, LOP-V is higher priority than RFI-V.

The far-end failure alarm hierarchy is shown in [Table 2-12](#), as given in Telcordia GR-253-CORE.

**Table 2-12** *Far-End Alarm Hierarchy*

| Priority | Condition Type |
|----------|----------------|
| Highest  | RFI-L          |
| —        | RFI-P          |
| Lowest   | RFI-V          |

## 2.5.5 Service Effect

Service-Affecting (SA) alarms—those that interrupt service—could be Critical (CR), Major (MJ), or Minor (MN) severity alarms. Service-Affecting (SA) alarms indicate service is affected. Non-Service-Affecting (NSA) alarms always have a Minor (MN) default severity.

## 2.5.6 States

The Alarms or History tab State (ST) column indicate the disposition of the alarm or condition as follows:

- A raised (R) event is one that is active.
- A cleared (C) event is one that is no longer active.
- A transient (T) event is one that is automatically raised and cleared in CTC during system changes such as user login, logout, loss of connection to node view, etc. Transient events do not require user action. These are listed in [Chapter 3, “Transient Conditions.”](#)

## 2.6 Safety Summary

This section covers safety considerations designed to ensure safe operation of the ONS 15454. Personnel should not perform any procedures in this chapter unless they understand all safety precautions, practices, and warnings for the system equipment. Some troubleshooting procedures require installation or removal of cards; in these instances users should pay close attention to the following caution.

**Caution**

Hazardous voltage or energy could be present on the backplane when the system is operating. Use caution when removing or installing cards.

Some troubleshooting procedures require installation or removal of OC-192 cards; in these instances users should pay close attention to the following warnings.

**Warning**

**On the OC-192 card, the laser is on when the card is booted and the safety key is in the on position (labeled 1). The port does not have to be in service for the laser to be on. The laser is off when the safety key is off (labeled 0).** Statement 293

**Warning**

**Invisible laser radiation could be emitted from the end of the unterminated fiber cable or connector. Do not stare into the beam directly with optical instruments. Viewing the laser output with certain optical instruments (for example, eye loupes, magnifiers, and microscopes) within a distance of 100 mm could pose an eye hazard.** Statement 1056

**Warning**

**Use of controls, adjustments, or performing procedures other than those specified could result in hazardous radiation exposure.** Statement 1057

**Warning**

**Class 1 laser product.** Statement 1008

**Warning**

**Do not reach into a vacant slot or chassis while you install or remove a module or a fan. Exposed circuitry could constitute an energy hazard.** Statement 206

**Warning**

**The power supply circuitry for the equipment can constitute an energy hazard. Before you install or replace the equipment, remove all jewelry (including rings, necklaces, and watches). Metal objects can come into contact with exposed power supply wiring or circuitry inside the DSLAM equipment. This could cause the metal objects to heat up and cause serious burns or weld the metal object to the equipment.** Statement 207

## 2.7 Alarm Procedures

This section lists alarms alphabetically and includes some conditions commonly encountered when troubleshooting alarms. The severity, description, and troubleshooting procedure accompany each alarm and condition.

**Note**

When you check the status of alarms for cards, ensure that the alarm filter icon in the lower right corner of the GUI is not indented. If it is, click it to turn it off. When you are done checking for alarms, you can click the alarm filter icon again to turn filtering back on. For more information about alarm filtering, refer to the “Manage Alarms” chapter in the *Cisco ONS 15454 Procedure Guide*.

**Note**

When checking alarms, ensure that alarm suppression is not enabled on the card or port. For more information about alarm suppression, refer to the “Manage Alarms” chapter in the *Cisco ONS 15454 Procedure Guide*.

**Note**

When an entity is put in the OOS,MT administrative state, the ONS 15454 suppresses all standing alarms on that entity and alarms and events appear on the Conditions tab. You can change this behavior for the LPBKFACILITY and LPBKTERMINAL alarms. To display these alarms on the Alarms tab, set the NODE.general.ReportLoopbackConditionsOnPortsInOOS-MT value to TRUE on the NE Defaults tab. For more information about changing NE defaults, refer to the “Maintain the Node” chapter in the *Cisco ONS 15454 Procedure Guide*.

## 2.7.1 AIS

Default Severity: Not Reported (NR), Non-Service-Affecting (NSA)

SONET Logical Objects: BITS, DS1, DS3, E1, FUDC, MSUDC

DWDM Logical Object: TRUNK

The Alarm Indication Signal (AIS) condition indicates that this node is detecting an alarm indication signal in the incoming signal SONET overhead.

Generally, any AIS is a special SONET signal that communicates to the receiving node when the transmit node does not send a valid signal. AIS is not considered an error. It is raised by the receiving node on each input when it detects the AIS instead of a real signal. In most cases when this condition is raised, an upstream node is raising an alarm to indicate a signal failure; all nodes downstream from it only raise some type of AIS. This condition clears when you resolved the problem on the upstream node.

**Note**

ONS 15454 DS-3 terminal (inward) loopbacks do not transmit an AIS in the direction away from the loopback. Instead of AIS, a continuance of the signal transmitted into the loopback is provided. A DS3/EC1-48 card can be provisioned to transmit AIS for a terminal loopback.

### Clear the AIS Condition

- Step 1** Determine whether there are alarms on the upstream nodes and equipment, especially the “LOS (OCN)” alarm on page 2-165, or if there are out-of-service (OOS,MT or OOS,DSBLD) ports.
- Step 2** Clear the upstream alarms using the applicable procedures in this chapter.
- Step 3** If the condition does not clear, log into the Technical Support Website at <http://www.cisco.com/techsupport> for more information or call Cisco TAC 1 800 553-2447.

## 2.7.2 AIS-L

Default Severity: Not Reported (NR), Non-Service-Affecting (NSA)

SONET Logical Objects: EC1, OCN

DWDM Logical Object: TRUNK

The AIS Line condition indicates that this node is detecting line-level AIS in the incoming signal. This alarm is secondary to another alarm occurring simultaneously in an upstream node.

This condition can also be raised in conjunction with the “TIM-S” alarm on page 2-247 if AIS-L is enabled.

**Note**

---

ONS 15454 DS-3 terminal (inward) loopbacks do not transmit an AIS in the direction away from the loopback. Instead of AIS, a continuance of the signal transmitted into the loopback is provided. A DS3/EC1-48 card can be provisioned to transmit AIS for a terminal loopback.

---

### Clear the AIS-L Condition

- 
- Step 1** Complete the “Clear the AIS Condition” procedure on page 2-37.
- Step 2** If the condition does not clear, log into the Technical Support Website at <http://www.cisco.com/techsupport> for more information or call Cisco TAC 1 800 553-2447.
- 

## 2.7.3 AIS-P

Default Severity: Not Reported (NR), Non-Service-Affecting (NSA)

SONET Logical Objects: STSMON, STSTRM

The AIS Path condition means that this node is detecting AIS in the incoming path. This alarm is secondary to another alarm occurring simultaneously in an upstream node.

### Clear the AIS-P Condition

- 
- Step 1** Complete the “Clear the AIS Condition” procedure on page 2-37.
- Step 2** If the condition does not clear, log into the Technical Support Website at <http://www.cisco.com/techsupport> for more information or call Cisco TAC 1 800 553-2447.
- 

## 2.7.4 AIS-V

Default Severity: Not Reported (NR), Non-Service-Affecting (NSA)

SONET Logical Objects: VT-MON, VT-TERM

The AIS VT condition means that this node is detecting AIS in the incoming VT-level path.

See the “1.11.2 AIS-V on DS3XM-6 or DS3XM-12 Unused VT Circuits” section on page 1-135 for more information.

## Clear the AIS-V Condition

- 
- Step 1** Complete the “Clear the AIS Condition” procedure on page 2-37.
- Step 2** If the condition does not clear, log into the Technical Support Website at <http://www.cisco.com/techsupport> for more information or call Cisco TAC 1 800 553-2447.
- 

## 2.7.5 ALS

For information about this alarm or condition, refer to the “Alarm Troubleshooting” chapter in the *Cisco ONS 15454 DWDM Troubleshooting Guide*. This guide discusses all DWDM alarms.

## 2.7.6 AMPLI-INIT

For information about this alarm or condition, refer to the “Alarm Troubleshooting” chapter in the *Cisco ONS 15454 DWDM Troubleshooting Guide*. This guide discusses all DWDM alarms.

## 2.7.7 APC-CORR-SKIPPED

For information about this alarm or condition, refer to the “Alarm Troubleshooting” chapter in the *Cisco ONS 15454 DWDM Troubleshooting Guide*. This guide discusses all DWDM alarms.

## 2.7.8 APC-DISABLED

For information about this alarm or condition, refer to the “Alarm Troubleshooting” chapter in the *Cisco ONS 15454 DWDM Troubleshooting Guide*. This guide discusses all DWDM alarms.

## 2.7.9 APC-END

For information about this alarm or condition, refer to the “Alarm Troubleshooting” chapter in the *Cisco ONS 15454 DWDM Troubleshooting Guide*. This guide discusses all DWDM alarms.

## 2.7.10 APC-OUT-OF-RANGE

For information about this alarm or condition, refer to the “Alarm Troubleshooting” chapter in the *Cisco ONS 15454 DWDM Troubleshooting Guide*. This guide discusses all DWDM alarms.

## 2.7.11 APC-WRONG-GAIN

For information about this alarm or condition, refer to the “Alarm Troubleshooting” chapter in the *Cisco ONS 15454 DWDM Troubleshooting Guide*. This guide discusses all DWDM alarms.

## 2.7.12 APSB

Default Severity: Minor (MN), Non-Service-Affecting (NSA)

SONET Logical Object: OCN

The APS Channel Byte Failure alarm occurs when LTE detects protection switching byte failure or an invalid switching code in the incoming APS signal. Some older SONET not manufactured by Cisco send invalid APS codes if they are configured in a 1+1 protection group with newer SONET nodes, such as the ONS 15454. These invalid codes cause an APSB alarm on an ONS 15454.

- 
- Step 1** Use an optical test set to examine the incoming SONET overhead to confirm inconsistent or invalid K bytes. For specific procedures to use the test set equipment, consult the manufacturer. If corrupted K bytes are confirmed and the upstream equipment is functioning properly, the upstream equipment might not interoperate effectively with the ONS 15454.
  - Step 2** If the alarm does not clear and the overhead shows inconsistent or invalid K bytes, you could need to replace the upstream cards for protection switching to operate properly. Complete the [“Physically Replace a Traffic Card” procedure on page 2-274](#).
  - Step 3** If the alarm does not clear, log into the Technical Support Website at <http://www.cisco.com/techsupport> for more information or call Cisco TAC 1 800 553-2447.
- 

## 2.7.13 APSCDFLTK

Default Severity: Minor (MN), Non-Service-Affecting (NSA)

SONET Logical Object: OCN

The APS Default K Byte Received alarm occurs during bidirectional line switched ring (BLSR) provisioning or when a BLSR is not properly configured, for example, when a four-node BLSR has one node configured as a unidirectional path switched ring (UPSR). When this misconfiguration occurs, a node in a UPSR or 1+1 configuration does not send the two valid K1/K2 APS bytes anticipated by a system configured for BLSR. One of the bytes sent is considered invalid by the BLSR configuration. The K1/K2 byte is monitored by receiving equipment for link-recovery information.

Troubleshooting for APSCDFLTK is often similar to troubleshooting for the [“BLSROSYNC” alarm on page 2-58](#).

### Clear the APSCDFLTK Alarm

- 
- Step 1** Complete the [“Identify a BLSR Ring Name or Node ID Number” procedure on page 2-261](#) to verify that each node has a unique node ID number.
  - Step 2** Repeat [Step 1](#) for all nodes in the ring.

- Step 3** If two nodes have the same node ID number, complete the “[Change a BLSR Node ID Number](#)” procedure on [page 2-262](#) to change one node ID number so that each node ID is unique.
- Step 4** If the alarm does not clear, verify correct configuration of east port and west port optical fibers. (See the “[E-W-MISMATCH](#)” alarm on [page 2-90](#).) West port fibers must connect to east port fibers and east port fibers must connect to west port fibers. The “[Install Cards and Fiber-Optic Cable](#)” chapter in the *Cisco ONS 15454 Procedure Guide* provides procedures for fibering BLSRs.
- Step 5** If the alarm does not clear and the network is a four-fiber BLSR, ensure that each protect fiber is connected to another protect fiber and each working fiber is connected to another working fiber. The software does not report any alarm if a working fiber is incorrectly attached to a protect fiber.
- Step 6** If the alarm does not clear, complete the “[Verify Node Visibility for Other Nodes](#)” procedure on [page 2-262](#).
- Step 7** If nodes are not visible, complete the “[Verify or Create Node Section DCC Terminations](#)” procedure on [page 2-276](#) to ensure that section data communications channel (SDCC) terminations exist on each node.
- Step 8** If the alarm does not clear, log into the Technical Support Website at <http://www.cisco.com/techsupport> for more information or call Cisco TAC 1 800 553-2447.
- 

## 2.7.14 APSC-IMP

Default Severity: Minor (MN), Non-Service-Affecting (NSA)

SONET Logical Object: OCN

An Improper SONET APS Code alarm indicates three consecutive, identical frames containing:

- Unused code in bits 6 through 8 of byte K2.
- Codes that are irrelevant to the specific protection switching operation being requested.
- Requests that are irrelevant to the ring state of the ring (such as a span protection switch request in a two-fiber ring NE).
- ET code in K2 bits 6 through 8 received on the incoming span, but not sourced from the outgoing span.



**Note**

This alarm can occur on a VT tunnel when it does not have VT circuits provisioned on it. It can also occur when the exercise command or a lockout is applied to a span. An externally switched span does not raise this alarm because traffic is preempted.

---



**Note**

The APSC-IMP alarm may be raised on a BLSR or MS-SPRing when a drop connection is part of a cross-connect loopback.

---



**Note**

The APSC-IMP alarm may be momentarily raised on BLSR spans during PCA circuit creation or deletion across multiple nodes using CTC.

---

**Warning**

**Invisible laser radiation could be emitted from the end of the unterminated fiber cable or connector. Do not stare into the beam directly with optical instruments. Viewing the laser output with certain optical instruments (for example, eye loupes, magnifiers, and microscopes) within a distance of 100 mm could pose an eye hazard.** Statement 1056

**Warning**

**Use of controls, adjustments, or performing procedures other than those specified could result in hazardous radiation exposure.** Statement 1057

## Clear the APSC-IMP Alarm

- Step 1** Use an optical test set to determine the validity of the K byte signal by examining the received signal. For specific procedures to use the test set equipment, consult the manufacturer.

**Caution**

Always use the supplied electrostatic discharge wristband when working with a powered ONS 15454. Plug the wristband cable into the ESD jack located on the lower-right edge of the shelf assembly.

If the K byte is invalid, the problem lies with upstream equipment and not with the reporting ONS 15454. Troubleshoot the upstream equipment using the procedures in this chapter, as applicable. If the upstream nodes are not ONS 15454s, consult the appropriate user documentation.

- Step 2** If the K byte is valid, verify that each node has a ring name that matches the other node ring names. Complete the [“Identify a BLSR Ring Name or Node ID Number” procedure on page 2-261](#).
- Step 3** Repeat [Step 2](#) for all nodes in the ring.
- Step 4** If a node has a ring name that does not match the other nodes, make that node’s ring name identical to the other nodes. Complete the [“Change a BLSR Ring Name” procedure on page 2-261](#).
- Step 5** If the alarm does not clear, log into the Technical Support Website at <http://www.cisco.com/techsupport> for more information or call Cisco TAC 1 800 553-2447.

## 2.7.15 APSCINCON

Default Severity: Minor (MN), Non-Service-Affecting (NSA)

SONET Logical Object: OCN

An APS Inconsistent alarm means that an inconsistent APS byte is present. The SONET overhead contains K1/K2 APS bytes that notify receiving equipment, such as the ONS 15454, to switch the SONET signal from a working to a protect path when necessary. An inconsistent APS code occurs when three consecutive frames contain nonidentical APS bytes, which in turn give the receiving equipment conflicting commands about switching.

### Clear the APSCINCON Alarm

- Step 1** Look for other alarms, especially the [“LOS \(OCN\)” alarm on page 2-165](#), the [“LOF \(OCN\)” alarm on page 2-152](#), or the [“AIS” condition on page 2-37](#). Clearing these alarms clears the APSCINCON alarm.



- Step 2** If an APSINCON alarm occurs with no other alarms, log into the Technical Support Website at <http://www.cisco.com/techsupport> for more information or call Cisco TAC 1 800 553-2447.
- 

## 2.7.16 APSCM

Default Severity: Major (MJ), Service-Affecting (SA)

SONET Logical Object: OCN

The APS Channel Mismatch alarm occurs when the ONS 15454 expects a working channel but receives a protect channel. In many cases, the working and protect channels are crossed and the protect channel is active. If the fibers are crossed and the working line is active, the alarm does not occur. The APSCM alarm occurs only on the ONS 15454 when bidirectional protection is used on OC-N cards in a 1+1 protection group configuration. The APSCM alarm does not occur in an optimized 1+1 protection configuration.



**Warning**

**On the ONS 15454 OC-192 card, the laser is on when the card is booted and the safety key is in the on position (labeled 1). The port does not have to be in service for the laser to be on. The laser is off when the safety key is off (labeled 0).** Statement 293

---



**Warning**

**Invisible laser radiation could be emitted from the end of the unterminated fiber cable or connector. Do not stare into the beam directly with optical instruments. Viewing the laser output with certain optical instruments (for example, eye loupes, magnifiers, and microscopes) within a distance of 100 mm could pose an eye hazard.** Statement 1056

---



**Warning**

**Use of controls, adjustments, or performing procedures other than those specified could result in hazardous radiation exposure.** Statement 1057

---

## Clear the APSCM Alarm



**Caution**

Always use the supplied electrostatic discharge wristband when working with a powered ONS 15454. Plug the wristband cable into the ESD jack located on the lower-right edge of the shelf assembly.

---

- Step 1** Verify that the working-card channel fibers are physically connected directly to the adjoining node's working-card channel fibers.
- Step 2** If the fibers are correctly connected, verify that the protection-card channel fibers are physically connected directly to the adjoining node's protection-card channel fibers.
- Step 3** If the alarm does not clear, log into the Technical Support Website at <http://www.cisco.com/techsupport> for more information or call Cisco TAC 1 800 553-2447 in order to report a Service-Affecting (SA) problem.
-

## 2.7.17 APSCNMIS

Default Severity: Major (MJ), Service-Affecting (SA)

SONET Logical Object: OCN

The APS Node ID Mismatch alarm occurs when the source node ID contained in the incoming APS channel K2 byte is not present in the ring map. The APSCNMIS alarm could occur and clear when a BLSR is being provisioned. If so, you can disregard the temporary occurrence. If the APSCNMIS remains, the alarm clears when a K byte with a valid source node ID is received.

### Clear the APSCNMIS Alarm

- 
- Step 1** Complete the [“Identify a BLSR Ring Name or Node ID Number” procedure on page 2-261](#) to verify that each node has a unique node ID number.
  - Step 2** If the Node ID column contains any two nodes with the same node ID listed, record the repeated node ID.
  - Step 3** Click **Close** in the Ring Map dialog box.
  - Step 4** If two nodes have the same node ID number, complete the [“Change a BLSR Node ID Number” procedure on page 2-262](#) to change one node ID number so that each node ID is unique.



---

**Note** If the node names shown in the network view do not correlate with the node IDs, log into each node and click the **Provisioning > BLSR** tabs. The BLSR window shows the node ID of the login node.

---



---

**Note** Applying and removing a lockout on a span causes the ONS node to generate a new K byte. The APSCNMIS alarm clears when the node receives a K byte containing the correct node ID.

---

- Step 5** If the alarm does not clear, use the [“Initiate a Lockout on a BLSR Protect Span” procedure on page 2-269](#) to lock out the span.
  - Step 6** Complete the [“Clear a BLSR External Switching Command” procedure on page 2-270](#) to clear the lockout.
  - Step 7** If the alarm does not clear, log into the Technical Support Website at <http://www.cisco.com/techsupport> for more information or call Cisco TAC 1 800 553-2447 in order to report a Service-Affecting (SA) problem.
- 

## 2.7.18 APSIMP

Default Severity: Minor (MN), Non-Service-Affecting (NSA)

SONET Logical Object: OCN

The APS Invalid Code alarm occurs if a 1+1 protection group is not properly configured at both nodes to send or receive the correct APS byte. A node that is either configured for no protection or is configured for UPSR or BLSR protection does not send the right K2 APS byte anticipated by a system configured for 1+1 protection. The 1+1 protect port monitors the incoming K2 APS byte and raises this alarm if it does not receive the byte.

The alarm is superseded by an APSCM or APSMM alarm, but not by an AIS condition. It clears when the port receives a valid code for 10 ms.

## Clear the APSIMP Alarm

- 
- Step 1** Check the configuration of the other node in the 1+1 protection group. If the far end is not configured for 1+1 protection, create the group. For procedures, refer to the “Turn Up Node” chapter in the *Cisco ONS 15454 Procedure Guide*.
  - Step 2** If the other end of the group is properly configured or the alarm does not clear after you have provisioned the group correctly, verify that the working ports and protect ports are cabled correctly.
  - Step 3** Ensure that both protect ports are configured for SONET.
  - Step 4** If the alarm does not clear, log into the Technical Support Website at <http://www.cisco.com/techsupport> for more information or call Cisco TAC 1 800 553-2447.
- 

## 2.7.19 APS-INV-PRIM

Default Severity: Minor (MN), Non-Service Affecting (NSA)

SONET Logical Object: OCN

The Optimized 1+1 APS Primary Facility condition occurs on OC-N cards in an optimized 1+1 protection system if the incoming primary section header does not indicate whether it is primary or secondary.



### Note

---

APS-INV-PRIM is an informational condition and does not require troubleshooting. If the APS switch is related to other alarms, troubleshoot these alarms as necessary using the procedures in this chapter.

---

## 2.7.20 APSMM

Default Severity: Minor (MN), Non-Service-Affecting (NSA)

SONET Logical Object: OCN

An APS Mode Mismatch failure alarm occurs on OC-N cards when there is a mismatch of the protection switching schemes at the two ends of the span, such as being bidirectional at one end and unidirectional at the other. Each end of a span must be provisioned the same way: bidirectional and bidirectional, or unidirectional and unidirectional. APSMM can also occur if third-party equipment is provisioned as 1:N and the ONS 15454 is provisioned as 1+1.

If one end is provisioned for 1+1 protection switching and the other is provisioned for UPSR protection switching, an APSMM alarm occurs in the ONS 15454 that is provisioned for 1+1 protection switching.

## Clear the APSMM Alarm

- 
- Step 1** For the reporting ONS 15454, display node view and verify the protection scheme provisioning:
    - a. Click the **Provisioning > Protection** tabs.

- b. Click the 1+1 protection group configured for the OC-N cards.

The chosen protection group is the protection group optically connected (with data communications channel, or DCC, connectivity) to the far end.

- c. Click **Edit**.
- d. Record whether the Bidirectional Switching check box is checked.

**Step 2** Click **OK** in the Edit Protection Group dialog box.

**Step 3** Log into the far-end node and verify that the OC-N 1+1 protection group is provisioned.

**Step 4** Verify that the Bidirectional Switching check box matches the checked or unchecked condition of the box recorded in [Step 1](#). If not, change it to match.

**Step 5** Click **Apply**.

**Step 6** If the alarm does not clear, log into the Technical Support Website at <http://www.cisco.com/techsupport> for more information or call Cisco TAC 1 800 553-2447.

## 2.7.21 APS-PRIM-FAC

Default Severity: Not Alarmed (NA), Non-Service Affecting (NSA)

SONET Logical Object: OCN

The Optimized 1+1 APS Invalid Primary Section condition occurs on OC-N cards in an optimized 1+1 protection system if there is an APS status switch between the primary and secondary facilities to identify which port is primary.



### Note

APS-PRIM-FAC is an informational condition and does not require troubleshooting. If the APS switch is related to other alarms, troubleshoot these alarms as necessary using the procedures in this chapter.

### Clear the APS-PRIM-FAC Condition

**Step 1** This condition clears when the card receives a valid primary section indication (1 or 2).

**Step 2** If the alarm does not clear, log into the Technical Support Website at <http://www.cisco.com/techsupport> for more information or call Cisco TAC 1 800 553-2447.

## 2.7.22 APS-PRIM-SEC-MISM

Default Severity: Minor (MN), Non-Service Affecting (NSA)

SONET Logical Object: OCN

The Optimized 1+1 APS Primary Section Mismatch condition occurs on OC-N cards in an optimized 1+1 protection system if there is a mismatch between the primary section of the local node facility and the primary section of the remote-node facility.

## Clear the APS-PRIM-SEC-MISM Alarm

- 
- Step 1** Ensure that the local node and remote-node ports are correctly provisioned the same way. For more information about optimized 1+1 configurations, refer to the “Turn Up Node” chapter in the *Cisco ONS 15454 Procedure Guide*.
- Step 2** If the alarm does not clear, log into the Technical Support Website at <http://www.cisco.com/techsupport> for more information or call Cisco TAC 1 800 553-2447.
- 

## 2.7.23 AS-CMD

Default Severity: Not Alarmed (NA), Non-Service-Affecting (NSA)

SONET Logical Objects: BPLANE, CE1000, CE100T, DS1, DS3, E1, E1000F, E100T, EC1, EQPT, FCMR, G1000, GFP-FAC, ML1000, ML100T, MLFX, NE, OCN, PWR

DWDM Logical Objects: 2R, AOTS, ESCON, FC, GE, ISC, OCH, OMS, OTS, PPM, SHELF, TRUNK

The Alarms Suppressed by User Command condition applies to the network element (NE object), backplane, a single card, or a port on a card. It occurs when alarms are suppressed for that object and its subordinate objects. For example, suppressing alarms on a card also suppresses alarms on its ports.



---

**Note** For more information about suppressing alarms, refer to the “Manage Alarms” chapter in the *Cisco ONS 15454 Procedure Guide*.

---

## Clear the AS-CMD Condition

- 
- Step 1** For all nodes, in node view, click the **Conditions** tab.
- Step 2** Click **Retrieve**. If you have already retrieved conditions, look under the Object column and Eqpt Type column and note what entity the condition is reported against, such as a port, slot, or shelf.
- If the condition is reported against a slot and card, alarms were either suppressed for the entire card or for one of the ports. Note the slot number and continue with [Step 3](#).
  - If the condition is reported against the backplane, go to [Step 7](#).
  - If the condition is reported against the NE object, go to [Step 8](#).
- Step 3** Determine whether alarms are suppressed for a port and if so, raise the suppressed alarms:
- a. Double-click the card to open the card view.
  - b. Click the **Provisioning > Alarm Profiles > Alarm Behavior** tabs and complete one of the following substeps:
    - If the Suppress Alarms column check box is checked for a port row, deselect it and click **Apply**.
    - If the Suppress Alarms column check box is not checked for a port row, from the View menu choose **Go to Previous View**.
- Step 4** If the AS-CMD condition is reported for a card and not an individual port, in node view click the **Provisioning > Alarm Profiles > Alarm Behavior** tabs.

- Step 5** Locate the row number for the reported card slot.
- Step 6** Click the **Suppress Alarms** column check box to deselect the option for the card row.
- Step 7** If the condition is reported for the backplane, the alarms are suppressed for cards such as the ONS 15454 AIP that are not in the optical or electrical slots. To clear the alarm, complete the following steps:
- In node view, click the **Provisioning > Alarm Profiles > Alarm Behavior** tabs.
  - In the backplane row, uncheck the **Suppress Alarms** column check box.
  - Click **Apply**.
- Step 8** If the condition is reported for the shelf, cards and other equipment are affected. To clear the alarm, complete the following steps:
- In node view, click the **Provisioning > Alarm Profiles > Alarm Behavior** tabs if you have not already done so.
  - Click the **Suppress Alarms** check box located at the bottom of the window to deselect the option.
  - Click **Apply**.
- Step 9** If the condition does not clear, log into the Technical Support Website at <http://www.cisco.com/techsupport> for more information or call Cisco TAC 1 800 553-2447.
- 

## 2.7.24 AS-MT

Default Severity: Not Alarmed (NA), Non-Service-Affecting (NSA)

SONET Logical Objects: CE1000, CE100T, DS1, DS3, E1, EC1, EQPT, FCMR, G1000, GFP-FAC, ML1000, ML100T, MLFX, OCN

DWDM Logical Objects: 2R, AOTS, ESCON, FC, GE, ISC, OCH, OMS, OTS, PPM, SHELF, TRUNK

The Alarms Suppressed for Maintenance Command condition applies to OC-N and electrical cards and occurs when a port is placed in the Out-of-Service and Management, Maintenance (OOS-MA,MT) service state for loopback testing operations.

### Clear the AS-MT Condition

- Step 1** Complete the [“Clear an OC-N Card Facility or Terminal Loopback Circuit” procedure on page 2-276](#).
- Step 2** If the condition does not clear, log into the Technical Support Website at <http://www.cisco.com/techsupport> for more information or call Cisco TAC 1 800 553-2447.
- 

## 2.7.25 AS-MT-OOG

Default Severity: Not Alarmed (NA), Non-Service-Affecting (NSA)

SONET Logical Objects: STSTRM, VT-TERM

The Alarms Suppressed on an Out-Of-Group VCAT Member condition is raised on an STS or VT member of a VCAT group whenever the member is in the IDLE (AS-MT-OOG) admin state. This condition can be raised when a member is initially added to a group. In the IDLE (AS-MT-OOG) state, all other alarms for the STS or VT are suppressed.

The AS-MT-OOG condition clears when an STS or VT member transitions to a different state from IDLE (AS-MT-OOG) or when the member is removed completely from the VCAT group. The condition does not require troubleshooting unless it does not clear.

If the condition does not clear, log into the Technical Support Website at <http://www.cisco.com/techsupport> for more information or call Cisco TAC 1 800 553-2447.

## 2.7.26 AUD-LOG-LOSS

Default Severity: Not Alarmed (NA), Non-Service-Affecting (NSA)

SONET Logical Object: NE

The Audit Trail Log Loss condition occurs when the log is 100 percent full and the oldest entries are being replaced while new entries are generated. The log capacity is 640 entries. The log must be off-loaded using the following procedure to make room for more entries.

### Clear the AUD-LOG-LOSS Condition

- 
- Step 1** In node view, click the **Maintenance > Audit** tabs.
  - Step 2** Click **Retrieve**.
  - Step 3** Click **Archive**.
  - Step 4** In the Archive Audit Trail dialog box, navigate to the directory (local or network) where you want to save the file.
  - Step 5** Enter a name in the **File Name** field.  
You do not have to assign an extension to the file. It is readable in any application that supports text files, such as WordPad, Microsoft Word (imported), etc.
  - Step 6** Click **Save**.  
The 640 entries are saved in this file. New entries continue with the next number in the sequence, rather than starting over.
  - Step 7** If the alarm does not clear, log into the Technical Support Website at <http://www.cisco.com/techsupport> for more information or call Cisco TAC 1 800 553-2447.
- 

## 2.7.27 AUD-LOG-LOW

Default Severity: Not Alarmed (NA), Non-Service-Affecting (NSA)

SONET Logical Object: NE

The Audit Trail Log Low condition occurs when the audit trail log is 80 percent full.

**Note**

AUD-LOG-LOW is an informational condition and does not require troubleshooting.

## 2.7.28 AUTOLSROFF

Default Severity: Critical (CR), Service-Affecting (SA)

SONET Logical Object: OCN

The Auto Laser Shutdown alarm occurs when the OC-192 card temperature exceeds 194 degrees F (90 degrees C). The internal equipment automatically shuts down the OC-192 laser when the card temperature rises to prevent the card from self-destructing.

**Warning**

**On the ONS 15454 OC-192 card, the laser is on when the card is booted and the safety key is in the on position (labeled 1). The port does not have to be in service for the laser to be on. The laser is off when the safety key is off (labeled 0).** Statement 293

**Warning**

**Invisible laser radiation could be emitted from the end of the unterminated fiber cable or connector. Do not stare into the beam directly with optical instruments. Viewing the laser output with certain optical instruments (for example, eye loupes, magnifiers, and microscopes) within a distance of 100 mm could pose an eye hazard.** Statement 1056

**Warning**

**Use of controls, adjustments, or performing procedures other than those specified could result in hazardous radiation exposure.** Statement 1057

### Clear the AUTOLSROFF Alarm

**Step 1** View the temperature displayed on the ONS 15454 LCD front panel ([Figure 2-1](#)).

**Figure 2-1 Shelf LCD Panel**

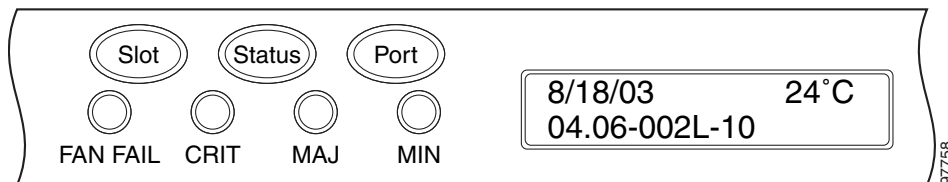

**Step 2** If the temperature of the shelf exceeds 194 degrees F (90 degrees C), the alarm should clear if you solve the ONS 15454 temperature problem. Complete the [“Clear the HITEMP Alarm” procedure on page 2-125](#).

**Step 3** If the temperature of the shelf is under 194 degrees F (90 degrees C), the HITEMP alarm is not the cause of the AUTOLSROFF alarm. Complete the [“Physically Replace a Traffic Card” procedure on page 2-274](#) for the OC-192 card.



- Step 4** If card replacement does not clear the alarm, call Cisco TAC 1 800 553-2447 to discuss the case and if necessary open a returned materials authorization (RMA) on the original OC-192 card.
- 

## 2.7.29 AUTONEG-RFI

Default Severity: Major (MJ), Service-Affecting (SA)

SONET Logical Object: ML1000

The autonegotiation remote fault indication (RFI) indicates that an ML1000 Gigabit Ethernet port cannot detect its far-end link partner. This is typically caused by a far-end port shutdown or a unidirectional fiber cut. The partner node is likely raising a CARLOSS alarm.

AUTONEG-RFI may also be caused by misconfigured autonegotiation parameters. This causes more of a soft failure as opposed to the “[CARLOSS \(ML1000, ML100T, MLFX\)](#)” alarm on page 2-66, which is typically caused by a failure like a loss of light or optical fiber. The alarm clears when the partner node is detected.



**Note**

The far end of an Ethernet link is usually a switch or router that does not use an ONS management system.

---

### Clear the AUTONEG-RFI Alarm

- Step 1** Check for the “[CARLOSS \(EQPT\)](#)” alarm on page 2-61 or the “[CARLOSS \(ML1000, ML100T, MLFX\)](#)” alarm on page 2-66 at the partner node. If the alarm exists there, follow the appropriate clearing procedure in this chapter.
- Step 2** If the alarm does not clear or if there is no far-end CARLOSS, check the near-end Gigabit Ethernet port autonegotiation settings:
- Double-click the ML1000 card to display the card view.
  - Click the upper IOS tab, then click **Open IOS Connection**.
  - In Privileged Executive mode, enter the following command:  

```
router# show interface gigabitethernet 0
```
  - View the command output and record the autonegotiation setting, such as the following example:  

```
Full-duplex, 1000Mb/s, Gbic not connected, Auto-negotiation
output flow-control is off, input flow-control is on
```
- Step 3** View the autonegotiation configuration for the partner node. If it is ONS equipment, follow the previous step for this node. If the node is different vendor client equipment, follow that equipment documentation to obtain the information.
- Step 4** If the alarm does not clear, check for any fiber breaks such as on the transmit cable from the partner node to the near-end node.
- Step 5** If the alarm does not clear, log into the Technical Support Website at <http://www.cisco.com/techsupport> for more information or call Cisco TAC 1 800 553-2447 to report a Service-Affecting (SA) problem.
-

## 2.7.30 AUTORESET

Default Severity: Minor (MN), Non-Service-Affecting (NSA)

SONET Logical Object: EQPT

The Automatic System Reset alarm occurs when you change an IP address or perform any other operation that causes an automatic card-level reboot. AUTORESET typically clears after a card reboots (up to ten minutes).

Resets performed during a software upgrade also prompt the condition. This condition clears automatically when the card finishes resetting. If the alarm does not clear, complete the following procedure.

### Clear the AUTORESET Alarm

- 
- Step 1** Determine whether there are additional alarms that could have triggered an automatic reset. If there are, troubleshoot these alarms using the applicable section of this chapter.
  - Step 2** If the card automatically resets more than once a month with no apparent cause, complete the [“Physically Replace a Traffic Card” procedure on page 2-274](#).
  - Step 3** If the alarm does not clear, log into the Technical Support Website at <http://www.cisco.com/techsupport> for more information or call Cisco TAC 1 800 553-2447.
- 

## 2.7.31 AUTOSW-AIS

Default Severity: Not Reported (NR), Non-Service-Affecting (NSA)

SONET Logical Objects: STSMON, VT-MON

The Automatic unidirectional path-switched ring (UPSR) Switch Caused by an AIS condition indicates that automatic UPSR protection switching occurred because of an AIS condition. If the UPSR is configured for revertive switching, it reverts to the working path after the fault clears. The AIS also clears when the upstream trouble is cleared.



#### Note

---

This condition is only reported if the path protection is set up for revertive switching.

---

Generally, any AIS is a special SONET signal that communicates to the receiving node when the transmit node does not send a valid signal. AIS is not considered an error. It is raised by the receiving node on each input when it detects the AIS instead of a real signal. In most cases when this condition is raised, an upstream node is raising an alarm to indicate a signal failure; all nodes downstream from it only raise some type of AIS. This condition clears when you resolved the problem on the upstream node.

### Clear the AUTOSW-AIS Condition

- 
- Step 1** Complete the [“Clear the AIS Condition” procedure on page 2-37](#).

- Step 2** If the condition does not clear, log into the Technical Support Website at <http://www.cisco.com/techsupport> for more information or call Cisco TAC 1 800 553-2447.
- 

## 2.7.32 AUTOSW-LOP (STSMON)

Default Severity: Not Alarmed (NA), Non-Service-Affecting (NSA)

SONET Logical Object: STSMON

The Automatic UPSR Switch Caused by LOP condition for the STS monitor (STSMON) indicates that automatic UPSR protection switching occurred because of the “LOP-P” alarm on page 2-155. If the UPSR is configured for revertive switching, it reverts to the working path after the fault clears.



**Note**

This condition is only reported if the path protection is set up for revertive switching.

---

### Clear the AUTOSW-LOP (STSMON) Condition

---

- Step 1** Complete the “[Clear the LOP-P Alarm](#)” procedure on page 2-156.
- Step 2** If the condition does not clear, log into the Technical Support Website at <http://www.cisco.com/techsupport> for more information or call Cisco TAC 1 800 553-2447.
- 

## 2.7.33 AUTOSW-LOP (VT-MON)

Default Severity: Not Alarmed (NA), Service-Affecting (SA)

SONET Logical Object: VT-MON

The AUTOSW-LOP alarm for the VT monitor (VT-MON) indicates that automatic UPSR protection switching occurred because of the “LOP-V” alarm on page 2-156. If the UPSR is configured for revertive switching, it reverts to the working path after the fault clears.



**Note**

This condition is only reported if the path protection is set up for revertive switching.

---

### Clear the AUTOSW-LOP (VT-MON) Condition

---

- Step 1** Complete the “[Clear the LOP-V Alarm](#)” procedure on page 2-156.
- Step 2** If the alarm does not clear, log into the Technical Support Website at <http://www.cisco.com/techsupport> for more information or call Cisco TAC 1 800 553-2447 in order to report a Service-Affecting (SA) problem.
-

## 2.7.34 AUTOSW-PDI

Default Severity: Not Alarmed (NA), Non-Service-Affecting (NSA)

SONET Logical Object: STSMON, VT-MON

The Automatic UPSR Switch Caused by Payload Defect Indication (PDI) condition indicates that automatic UPSR protection switching occurred because of a “PDI-P” alarm on page 2-194. If the UPSR is configured for revertive switching, it reverts to the working path after the fault clears.

**Note**

---

This condition is only reported if the path protection is set up for revertive switching.

---

### Clear the AUTOSW-PDI Condition

- 
- Step 1** Complete the “[Clear the PDI-P Condition](#)” procedure on page 2-195.
- Step 2** If the condition does not clear, log into the Technical Support Website at <http://www.cisco.com/techsupport> for more information or call Cisco TAC 1 800 553-2447.
- 

## 2.7.35 AUTOSW-SDBER

Default Severity: Not Alarmed (NA), Non-Service-Affecting (NSA)

Logical Object: STSMON, VT-MON

The Automatic UPSR Switch Caused by Signal Degrade Bit Error Rate (SDBER) condition indicates that a “SD-P” condition on page 2-221 caused automatic UPSR protection switching to occur. If the path protection is configured for revertive switching, the path protection reverts to the working path when the SD-P is resolved.

**Note**

---

This condition is only reported if the path protection is set up for revertive switching.

---

### Clear the AUTOSW-SDBER Condition

- 
- Step 1** Complete the “[Clear the SD-P Condition](#)” procedure on page 2-222.
- Step 2** If the condition does not clear, log into the Technical Support Website at <http://www.cisco.com/techsupport> for more information or call Cisco TAC 1 800 553-2447.
- 

## 2.7.36 AUTOSW-SFBER

Default Severity: Not Alarmed (NA), Non-Service-Affecting (NSA)

Logical Object: STSMON, VT-MON

The Automatic USPR Switch Caused by Signal Fail Bit Error Rate (SFBER) condition indicates that a “SF-P” condition on page 2-225 caused automatic UPSR protection switching to occur. If the path protection is configured for revertive switching, the path protection reverts to the working path when the SF-P is resolved.

**Note**

This condition is only reported if the path protection is set up for revertive switching.

## Clear the AUTOSW-SFBER Condition

- 
- Step 1** Complete the “Clear the SF-P Condition” procedure on page 2-225.
- Step 2** If the condition does not clear, log into the Technical Support Website at <http://www.cisco.com/techsupport> for more information or call Cisco TAC 1 800 553-2447.
- 

## 2.7.37 AUTOSW-UNEQ (STSMON)

Default Severity: Not Alarmed (NA), Non-Service-Affecting (NSA)

SONET Logical Object: STSMON

The Automatic UPSR Switch Caused by Unequipped condition indicates that an “UNEQ-P” alarm on page 2-253, caused automatic UPSR protection switching to occur. If the UPSR is configured for revertive switching, it reverts to the working path after the fault clears.

**Note**

This condition is only reported if the path protection is set up for revertive switching.

## Clear the AUTOSW-UNEQ (STSMON) Condition

- 
- Step 1** Complete the “Clear the UNEQ-P Alarm” procedure on page 2-253.
- Step 2** If the condition does not clear, log into the Technical Support Website at <http://www.cisco.com/techsupport> for more information or call Cisco TAC 1 800 553-2447.
- 

## 2.7.38 AUTOSW-UNEQ (VT-MON)

Default Severity: Minor (MN), Non-Service-Affecting (NSA)

SONET Logical Object: VT-MON

AUTOSW-UNEQ (VT-MON) indicates that the “UNEQ-V” alarm on page 2-255 caused automatic path protection switching to occur. If the path protection is configured for revertive switching, it reverts to the working path after the fault clears.

**Note**

This condition is only reported if the path protection is set up for revertive switching.

## Clear the AUTOSW-UNEQ (VT-MON) Condition

- 
- Step 1** Complete the “[Clear the UNEQ-V Alarm](#)” procedure on page 2-255.
- Step 2** If the alarm does not clear, log into the Technical Support Website at <http://www.cisco.com/techsupport> for more information or call Cisco TAC (1 800 553-2447) in order to report a Service-Affecting (SA) problem.
- 

## 2.7.39 AWG-DEG

For information about this alarm or condition, refer to the “Alarm Troubleshooting” chapter in the *Cisco ONS 15454 DWDM Troubleshooting Guide*. This guide discusses all DWDM alarms.

## 2.7.40 AWG-FAIL

For information about this alarm or condition, refer to the “Alarm Troubleshooting” chapter in the *Cisco ONS 15454 DWDM Troubleshooting Guide*. This guide discusses all DWDM alarms.

## 2.7.41 AWG-OVERTEMP

For information about this alarm or condition, refer to the “Alarm Troubleshooting” chapter in the *Cisco ONS 15454 DWDM Troubleshooting Guide*. This guide discusses all DWDM alarms.

## 2.7.42 AWG-WARM-UP

For information about this alarm or condition, refer to the “Alarm Troubleshooting” chapter in the *Cisco ONS 15454 DWDM Troubleshooting Guide*. This guide discusses all DWDM alarms.

## 2.7.43 BAT-FAIL

Default Severity: Major (MJ), Service-Affecting (SA)

SONET Logical Object: PWR

The Battery Fail alarm occurs when one of the two power supplies (A or B) is not detected. This could be because the supply is removed or is not operational. The alarm does not distinguish between the individual power supplies, so onsite information about the conditions is necessary for troubleshooting.

### Clear the BAT-FAIL Alarm

- 
- Step 1** At the site, determine which battery is not present or operational.
- Step 2** Remove the power cable from the faulty supply. For procedures, refer to the “Install the Shelf and Backplane Cable” chapter in the *Cisco ONS 15454 Procedure Guide*. Reverse the power cable installation procedure.

- Step 3** If the alarm does not clear, log into the Technical Support Website at <http://www.cisco.com/techsupport> for more information or call Cisco TAC 1 800 553-2447 in order to report a Service-Affecting (SA) problem.
- 

## 2.7.44 BKUPMEMP

Default Severity: Critical (CR), Service-Affecting (SA)

SONET Logical Object: EQPT

The Primary Nonvolatile Backup Memory Failure alarm refers to a problem with the TCC2/TCC2P flash memory. The alarm occurs when the TCC2/TCC2P is in use and has one of four problems:

- Flash manager fails to format a flash partition.
- Flash manager fails to write a file to a flash partition.
- Problem at the driver level.
- Code volume fails cyclic redundancy checking (CRC, a method to verify for errors in data transmitted to the TCC2/TCC2P).

The BKUPMEMP alarm can also cause the “EQPT” alarm on page 2-86. If the EQPT alarm is caused by BKUPMEMP, complete the following procedure to clear the BKUPMEMP and the EQPT alarm.



**Caution**

A software update on a standby TCC2/TCC2P can take up to 30 minutes.

---

### Clear the BKUPMEMP Alarm

- Step 1** Verify that both TCC2/TCC2Ps are powered and enabled by confirming lighted ACT/SBY LEDs on the TCC2/TCC2Ps.
- Step 2** Determine whether the active or standby TCC2/TCC2P has the alarm.
- Step 3** If both TCC2/TCC2Ps are powered and enabled, reset the TCC2/TCC2P where the alarm is raised. If the card is the active TCC2/TCC2P, complete the “[Reset an Active TCC2/TCC2P Card and Activate the Standby Card](#)” procedure on page 2-271. If the card is the standby TCC2/TCC2P:
- a. Right-click the standby TCC2/TCC2P in CTC.
  - b. Choose **Reset Card** from the shortcut menu.
  - c. Click **Yes** in the Are You Sure dialog box. The card resets, the FAIL LED blinks on the physical card.
  - d. Wait ten minutes to verify that the card you reset completely reboots.
- Step 4** If the TCC2/TCC2P you reset does not reboot successfully, or the alarm has not cleared, call Cisco TAC 1 800 553-2447. If the Cisco TAC technician tells you to reseat the card, complete the “[Remove and Reinsert \(Reseat\) the Standby TCC2/TCC2P Card](#)” procedure on page 2-273. If the Cisco TAC technician tells you to remove the card and reinstall a new one, follow the “[Physically Replace a Traffic Card](#)” procedure on page 2-274.
-

## 2.7.45 BLSROSYNC

Default Severity: Major (MJ), Service-Affecting (SA)

SONET Logical Object: OCN

The BLSR Out Of Synchronization alarm occurs is raised temporarily during a span upgrade, downgrade, or two-fiber to four-fiber mode upgrade and clears when the procedure is complete for all nodes on the ring. If the alarm does not clear, ensure that all maintenance procedures have completed for all nodes on the ring. If the alarm still does not clear, log into the Technical Support Website at <http://www.cisco.com/techsupport> for more information or call Cisco TAC 1 800 553-2447 in order to report a Service-Affecting (SA) problem.

## 2.7.46 BLSR-SW-VER-MISM

Default Severity: Major (MJ), Service-Affecting (SA)

SONET Logical Object: OCN

The BLSR Software Version Mismatch alarm is raised by the TCC2/TCC2P when it checks all software versions for all nodes in a ring and discovers a mismatch in versions.

### Clear the BLSR-SW-VER-MISM Alarm

- 
- Step 1** Clear the alarm by loading the correct software version on the TCC2/TCC2P with the incorrect load. To download software, refer to the release-specific software download document.
- Step 2** If the condition does not clear, log into the Technical Support Website at <http://www.cisco.com/techsupport> for more information or call Cisco TAC 1 800 553-2447 to report a Service-Affecting (SA) problem.
- 

## 2.7.47 BPV

Default Severity: Minor (MN), Non-Service-Affecting (NSA)

SONET Logical Object: BITS

The 64K Clock Bipolar Density Violation alarm is raised on the TCC2P card if there is a frequency variation in the 8K BITS clock.

The TCC2P card contains an 8K clock and a 64K clock. Each has some bipolar variation, which is normal. This alarm is raised on the 8K clock if that variation discontinues. The BPV alarm is demoted by an LOF or LOS against the BITS clock.



**Note**

---

This alarm is not raised on the TCC2 card.

---



## Clear the BPV Alarm

- 
- Step 1** Reestablishing a normal BITS input signal clears the alarm. Clear any alarms on the incoming signal or against the BITS timing sources.
- Step 2** If the alarm does not clear, log into the Technical Support Website at <http://www.cisco.com/techsupport> for more information or call Cisco TAC 1 800 553-2447 in order to report a Service-Affecting (SA) problem.
- 

## 2.7.48 CARLOSS (CE1000, CE100T)

Default Severity: Major (MJ), Service-Affecting (SA)

SONET Logical Objects: CE1000, CE100T

The Carrier Loss alarm is raised on CE-Series cards in Mapper mode when the port is In-Service (IS) state and if there is no carrier signal. Circuit need not be present to raise the alarm. In releases prior to 6.01 the Carrier Loss alarm is raised on CE-100T-8 cards in Mapper mode when there is a circuit failure due to link integrity. It does not get raised when a user simply puts the port in the In-Service and Normal (IS-NR) service state.

**Note**

For more information about Ethernet cards, refer to the *Cisco ONS 15454 and Cisco ONS 15454 SDH Ethernet Card Software Feature and Configuration Guide*.

---

## Clear the CARLOSS (CE1000, CE100T) Alarm

- 
- Step 1** Complete the “[Clear the CARLOSS \(G1000\) Alarm](#)” procedure on page 2-63. However, rather than checking for a TPTFAIL (G1000) at the end of the procedure, check for a “[TPTFAIL \(CE100T, CE1000\)](#)” alarm on page 2-248.
- Step 2** If the alarm does not clear, log into the Technical Support Website at <http://www.cisco.com/techsupport> for more information or call Cisco TAC 1 800 553-2447 in order to report a Service-Affecting (SA) problem.
- 

## 2.7.49 CARLOSS (E1000F, E100T)

Default Severity: Major (MJ), Service-Affecting (SA)

SONET Logical Objects: E1000F, E100T

A Carrier Loss alarm on the LAN E-Series Ethernet card is the data equivalent of the “[LOS \(OCN\)](#)” alarm on page 2-165. The Ethernet card has lost its link and is not receiving a valid signal. The most common causes of the CARLOSS alarm are a disconnected cable, an Ethernet Gigabit Interface Converter (GBIC) fiber connected to an optical card rather than an Ethernet device, or an improperly installed Ethernet card. Ethernet card ports must be enabled for CARLOSS to occur. CARLOSS is declared after no signal is received for approximately 2.5 seconds.

The CARLOSS alarm also occurs after a node database is restored. After restoration, the alarm clears in approximately 30 seconds after the node reestablishes Spanning Tree Protocol (STP).

**Note**

For more information about Ethernet cards, refer to the *Cisco ONS 15454 and Cisco ONS 15454 SDH Ethernet Card Software Feature and Configuration Guide*.

## Clear the CARLOSS (E1000F, E100T) Alarm

- Step 1** Verify that the fiber cable is properly connected and attached to the correct port. For more information about fiber connections and terminations, refer to the “Install Cards and Fiber-Optic Cable” chapter in the *Cisco ONS 15454 Procedure Guide*.

**Caution**

Always use the supplied electrostatic discharge wristband when working with a powered ONS 15454. Plug the wristband cable into the ESD jack located on the lower-right edge of the shelf assembly.

- Step 2** If the fiber cable is properly connected and attached to the port, verify that the cable connects the card to another Ethernet device and is not misconnected to an OC-N card. For more information about fiber connections and terminations, refer to the “Install Cards and Fiber-Optic Cable” chapter in the *Cisco ONS 15454 Procedure Guide*.
- Step 3** If no misconnection to an OC-N card exists, verify that the transmitting device is operational. If not, troubleshoot the device.
- Step 4** If the alarm does not clear, use an Ethernet test set to determine whether a valid signal is coming into the Ethernet port. For specific procedures to use the test set equipment, consult the manufacturer.
- Step 5** If a valid Ethernet signal is not present and the transmitting device is operational, replace the fiber cable connecting the transmitting device to the Ethernet port. To do this, refer to the “Install Cards and Fiber-Optic Cable” chapter in the *Cisco ONS 15454 Procedure Guide*.
- Step 6** If a valid Ethernet signal is present, complete the [“Remove and Reinsert \(Reseat\) Any Card” procedure on page 2-274](#) for the Ethernet card.
- Step 7** If the alarm does not clear, complete the [“Physically Replace a Traffic Card” procedure on page 2-274](#) for the Ethernet card.
- Step 8** If a CARLOSS alarm repeatedly appears and clears, use the following steps to examine the layout of your network to determine whether the Ethernet circuit is part of an Ethernet manual cross-connect.

An Ethernet manual cross-connect is used when another vendor’s equipment sits between ONS 15454 nodes, and the open systems interconnect/target identifier address resolution protocol (OSI/TARP)-based equipment does not allow tunneling of the ONS 15454 TCP/IP-based DCC. To circumvent a lack of continuous DCC, the Ethernet circuit is manually cross connected to an STS channel riding through the non-ONS network.

If the reporting Ethernet circuit is part of an Ethernet manual cross-connect, complete the following steps. The reappearing alarm could be a result of mismatched STS circuit sizes in the set up of the manual cross-connect. If the Ethernet circuit is not part of a manual cross-connect, the following steps do not apply.

- a. Right-click anywhere in the row of the CARLOSS alarm.
- b. Click **Select Affected Circuits** in the shortcut menu that appears.
- c. Record the information in the type and size columns of the highlighted circuit.

- d. From the examination of the layout of your network, determine which ONS 15454 and card and card are hosting the Ethernet circuit at the other end of the Ethernet manual cross-connect and complete the following substeps:
  - Log into the ONS 15454 at the other end of the Ethernet manual cross-connect.
  - Double-click the Ethernet card that is part of the Ethernet manual cross-connect.
  - Click the **Circuits** tab.
  - Record the information in the type and size columns of the circuit that is part of the Ethernet manual cross-connect. The Ethernet manual cross-connect circuit connects the Ethernet card to an OC-N card at the same node.
- e. Use the information you recorded to determine whether the two Ethernet circuits on each side of the Ethernet manual cross-connect have the same circuit size.

If one of the circuit sizes is incorrect, complete the [“Delete a Circuit” procedure on page 2-276](#) and reconfigure the circuit with the correct circuit size. For more information, refer to the “Create Circuits and VT Tunnels” chapter in the *Cisco ONS 15454 Procedure Guide*.

- Step 9** If the alarm does not clear, log into the Technical Support Website at <http://www.cisco.com/techsupport> for more information or call Cisco TAC 1 800 553-2447 in order to report a Service-Affecting (SA) problem.

## 2.7.50 CARLOSS (EQPT)

Default Severity: Major (MJ), Service-Affecting (SA)

SONET Logical Object: EQPT

A Carrier Loss on the LAN Equipment alarm generally occurs on OC-N cards when the ONS 15454 and the workstation hosting CTC do not have a TCP/IP connection. The problem involves the LAN or data circuit used by the RJ-45 (LAN) connector on the TCC2/TCC2P or the LAN backplane pin connection. This CARLOSS alarm does not involve an Ethernet circuit connected to an Ethernet port. The problem is in the connection and not CTC or the node.

On TXP\_MR\_10G, TXP\_MR\_2.5G, TXPP\_MR\_2.5G or MXP\_2.5G\_10G cards, CARLOSS is also raised against trunk ports when ITU-T G.709 monitoring is turned off.

A TXP\_MR\_2.5G card can raise a CARLOSS alarm when the payload is incorrectly configured for the 10 Gigabit Ethernet or 1 Gigabit Ethernet payload data types.



**Warning**

**Invisible laser radiation could be emitted from the end of the unterminated fiber cable or connector. Do not stare into the beam directly with optical instruments. Viewing the laser output with certain optical instruments (for example, eye loupes, magnifiers, and microscopes) within a distance of 100 mm could pose an eye hazard.** Statement 1056



**Warning**

**Use of controls, adjustments, or performing procedures other than those specified could result in hazardous radiation exposure.** Statement 1057

**Note**

For more information about provisioning MXP or TXP PPMs, refer to the “Provision Transponders and Muxponders” chapter of the *Cisco ONS 15454 DWDM Procedure Guide*. For more information about the cards themselves, refer to the *Cisco ONS 15454 DWDM Reference Manual*. For more information about MRC-12, MRC-4, and OC192-XFP/STM64-XFP cards, refer to the “Optical Cards” chapter in the *Cisco ONS 15454 Reference Manual*. For more information about Ethernet cards, refer to the “Ethernet Cards” chapter in the *Cisco ONS 15454 Reference Manual*.

## Clear the CARLOSS (EQPT) Alarm

- 
- Step 1** If the reporting card is an MXP or TXP card in an ONS 15454 node, verify the data rate configured on the pluggable port module (PPM):
- Double-click the reporting MXP or TXP card.
  - Click the **Provisioning > Pluggable Port Modules** tabs.
  - View the Pluggable Port Modules area port listing in the **Actual Equipment Type** column and compare this with the contents of the Selected PPM area Rate column for the MXP or TXP multirate port.
  - If the rate does not match the actual equipment, you must delete and recreate the selected PPM. Select the PPM, click **Delete**, then click **Create** and choose the correct rate for the port rate.
- Step 2** If the reporting card is an OC-N card, verify connectivity by pinging the ONS 15454 that is reporting the alarm by completing the [“1.9.8 Verify PC Connection to the ONS 15454 \(ping\)” procedure on page 1-119](#).
- Step 3** If the ping is successful, it demonstrates that an active TCP/IP connection exists. Restart CTC:
- Exit from CTC.
  - Reopen the browser.
  - Log into CTC.
- Step 4** Using optical test equipment, verify that proper receive levels are achieved. (For instructions to use optical test equipment, refer to the manufacturer documentation.)

**Caution**

Always use the supplied electrostatic discharge wristband when working with a powered ONS 15454. Plug the wristband cable into the ESD jack located on the lower-right edge of the shelf assembly.

- Step 5** Verify that the optical LAN cable is properly connected and attached to the correct port. For more information about fiber connections and terminations, refer to the “Install Cards and Fiber-Optic Cable” chapter in the *Cisco ONS 15454 Procedure Guide*.
- Step 6** If the fiber cable is properly connected and attached to the port, verify that the cable connects the card to another Ethernet device and is not misconnected to an OC-N card.
- Step 7** If you are unable to establish connectivity, replace the fiber cable with a new known-good cable. To do this, refer to the “Install Cards and Fiber-Optic Cable” chapter in the *Cisco ONS 15454 Procedure Guide*.
- Step 8** If you are unable to establish connectivity, perform standard network or LAN diagnostics. For example, trace the IP route, verify cable continuity, and troubleshoot any routers between the node and CTC. To verify cable continuity, follow site practices.

- Step 9** If the alarm does not clear, log into the Technical Support Website at <http://www.cisco.com/techsupport> for more information or call Cisco TAC 1 800 553-2447 in order to report a Service-Affecting (SA) problem.
- 

## 2.7.51 CARLOSS (FC)

For information about this alarm or condition, refer to the “Alarm Troubleshooting” chapter in the *Cisco ONS 15454 DWDM Troubleshooting Guide*. This guide discusses all DWDM alarms.

## 2.7.52 CARLOSS (G1000)

Default Severity: Major (MJ), Service-Affecting (SA)

SONET Logical Object: G1000

A Carrier Loss alarm on the LAN G-Series Ethernet card is the data equivalent of the “[LOS \(OCN\)](#)” alarm on [page 2-165](#). The Ethernet card has lost its link and is not receiving a valid signal.

CARLOSS on the G1000-4 card is caused by one of two situations:

- The G1000-4 port reporting the alarm is not receiving a valid signal from the attached Ethernet device. The CARLOSS can be caused by an improperly connected Ethernet cable or a problem with the signal between the Ethernet device and the G1000-4 port.
- If a problem exists in the end-to-end path (including possibly the far-end G1000-4 card), it causes the reporting card to turn off the Gigabit Ethernet transmitter. Turning off the transmitter typically causes the attached device to turn off its link laser, which results in a CARLOSS on the reporting G1000-4 card. The root cause is the problem in the end-to-end path. When the root cause is cleared, the far-end G1000-4 port turns the transmitter laser back on and clears the CARLOSS on the reporting card. If a turned-off transmitter causes the CARLOSS alarm, other alarms such as the “[TPTFAIL \(G1000\)](#)” alarm on [page 2-249](#) or OC-N alarms or conditions on the end-to-end path normally accompany the CARLOSS (G1000) alarm.

Refer to the *Cisco ONS 15454 Reference Manual* for a description of the G1000-4 card’s end-to-end Ethernet link integrity capability. Also see the “[TRMT](#)” alarm on [page 2-251](#) for more information about alarms that occur when a point-to-point circuit exists between two cards.

Ethernet card ports must be enabled for CARLOSS to occur. CARLOSS is declared after no signal is received for approximately 2.5 seconds.



**Note**

For more information about Ethernet cards, refer to the *Cisco ONS 15454 and Cisco ONS 15454 SDH Ethernet Card Software Feature and Configuration Guide*.

---

## Clear the CARLOSS (G1000) Alarm

- Step 1** Verify that the fiber cable is properly connected and attached to the correct port. For more information about fiber connections and terminations, refer to the “Install Cards and Fiber-Optic Cable” chapter in the *Cisco ONS 15454 Procedure Guide*.

**Caution**

Always use the supplied electrostatic discharge wristband when working with a powered ONS 15454. Plug the wristband cable into the ESD jack located on the lower-right edge of the shelf assembly.

- Step 2** If the fiber cable is correctly connected and attached, verify that the cable connects the card to another Ethernet device and is not misconnected to an OC-N card.
- Step 3** If no misconnection to the OC-N card exists, verify that the attached transmitting Ethernet device is operational. If not, troubleshoot the device.
- Step 4** Verify that optical receive levels are within the normal range. The correct specifications are listed in the [“1.12.3 OC-N Card Transmit and Receive Levels”](#) section on page 1-145.
- Step 5** If the alarm does not clear, use an Ethernet test set to determine whether a valid signal is coming into the Ethernet port. For specific procedures to use the test set equipment, consult the manufacturer.
- Step 6** If a valid Ethernet signal is not present and the transmitting device is operational, replace the fiber cable connecting the transmitting device to the Ethernet port. To do this, refer to the “Install Cards and Fiber-Optic Cable” chapter in the *Cisco ONS 15454 Procedure Guide*.
- Step 7** If the alarm does not clear, and link autonegotiation is enabled on the port but the autonegotiation process fails, the card turns off its transmitter laser and reports a CARLOSS alarm. If link autonegotiation has been enabled for the port, determine whether there are conditions that could cause autonegotiation to fail:
- a. Confirm that the attached Ethernet device has autonegotiation enabled and is configured for compatibility with the asymmetric flow control on the card.
  - b. Confirm that the attached Ethernet device configuration allows reception of flow control frames.
- Step 8** If the alarm does not clear, disable and reenable the Ethernet port to attempt to remove the CARLOSS condition. (The autonegotiation process restarts.)
- Step 9** If the alarm does not clear and the [“TPTFAIL \(G1000\)”](#) alarm on page 2-249 is also reported, complete the [“Clear the TPTFAIL \(G1000\) Alarm”](#) procedure on page 2-249. If the TPTFAIL alarm is not raised, continue to the next step.

**Note**

When the CARLOSS and the TPTFAIL alarms are reported, the reason for the condition could be the G1000-4 card's end-to-end link integrity feature taking action on a remote failure indicated by the TPTFAIL alarm.

- Step 10** If the TPTFAIL alarm was not raised, determine whether a terminal (inward) loopback has been provisioned on the port:
- a. In node view, click the card to go to card view.
  - b. Click the **Maintenance > Loopback** tabs.
  - c. If the service state is listed as OOS-MA,LPBK&MT, a loopback is provisioned. Go to [Step 11](#).
- Step 11** If a loopback was provisioned, complete the [“Clear Other Electrical Card or Ethernet Card Loopbacks”](#) procedure on page 2-278.
- On the G1000-4, provisioning a terminal (inward) loopback causes the transmit laser to turn off. If an attached Ethernet device detects the loopback as a loss of carrier, the attached Ethernet device shuts off the transmit laser to the G1000-4 card. Terminating the transmit laser could raise the CARLOSS alarm because the loopbacked G1000-4 port detects the termination.
- If the does not have a loopback condition, continue to [Step 12](#).

**Step 12** If a CARLOSS alarm repeatedly appears and clears, the reappearing alarm could be a result of mismatched STS circuit sizes in the setup of the manual cross-connect. Perform the following steps if the Ethernet circuit is part of a manual cross-connect:



**Note** An ONS 15454 Ethernet manual cross-connect is used when another vendor's equipment sits between ONS nodes, and the OSI/TARP-based equipment does not allow tunneling of the ONS 15454 TCP/IP-based DCC. To circumvent a lack of continuous DCC, the Ethernet circuit is manually cross connected to an STS channel riding through the non-ONS network.

- a. Right-click anywhere in the row of the CARLOSS alarm.
  - b. Right-click or left-click **Select Affected Circuits** in the shortcut menu that appears.
  - c. Record the information in the type and size columns of the highlighted circuit.
  - d. Examine the layout of your network and determine which ONS 15454 and card are hosting the Ethernet circuit at the other end of the Ethernet manual cross-connect and complete the following substeps:
    - Log into the node at the other end of the Ethernet manual cross-connect.
    - Double-click the Ethernet card that is part of the Ethernet manual cross-connect.
    - Click the **Circuits** tab.
    - Record the information in the type and size columns of the circuit that is part of the Ethernet manual cross-connect. The cross-connect circuit connects the Ethernet card to an OC-N card at the same node.
  - e. Determine whether the two Ethernet circuits on each side of the Ethernet manual cross-connect have the same circuit size from the circuit size information you recorded.
  - f. If one of the circuit sizes is incorrect, complete the [“Delete a Circuit” procedure on page 2-276](#) and reconfigure the circuit with the correct circuit size. Refer to the “Create Circuits and VT Tunnels” chapter in the *Cisco ONS 15454 Procedure Guide* for detailed procedures to create circuits.
- Step 13** If a valid Ethernet signal is present, complete the [“Remove and Reinsert \(Reseat\) Any Card” procedure on page 2-274](#).
- Step 14** If the alarm does not clear, complete the [“Physically Replace a Traffic Card” procedure on page 2-274](#) for the Ethernet card.
- Step 15** If the alarm does not clear, log into the Technical Support Website at <http://www.cisco.com/techsupport> for more information or call Cisco TAC 1 800 553-2447 in order to report a Service-Affecting (SA) problem.

## 2.7.53 CARLOSS (GE)

For information about this alarm or condition, refer to the “Alarm Troubleshooting” chapter in the *Cisco ONS 15454 DWDM Troubleshooting Guide*. This guide discusses all DWDM alarms.

## 2.7.54 CARLOSS (ISC)

For information about this alarm or condition, refer to the “Alarm Troubleshooting” chapter in the *Cisco ONS 15454 DWDM Troubleshooting Guide*. This guide discusses all DWDM alarms.



## 2.7.55 CARLOSS (ML1000, ML100T, MLFX)

Default Severity: Major (MJ), Service-Affecting (SA)

SONET Logical Objects: ML1000, ML100T, MLFX

A Carrier Loss alarm on an ML-Series Ethernet card is the data equivalent of the “[LOS \(OCN\)](#)” alarm on page 2-165. The Ethernet port has lost its link and is not receiving a valid signal.

A CARLOSS alarm occurs when the Ethernet port has been configured from the Cisco IOS command line interface (CLI) as a no-shutdown port and one of the following problems also occurs:

- The cable is not properly connected to the near or far port.
- Autonegotiation is failing (which raises the “[AUTONEG-RFI](#)” alarm on page 2-51).
- The speed (10/100 ports only) is set incorrectly.



### Note

For information about provisioning ML-Series Ethernet cards from the Cisco IOS interface, refer to the *Cisco ONS 15454 and Cisco ONS 15454 SDH Ethernet Card Software Feature and Configuration Guide*.

## Clear the CARLOSS (ML1000, ML100T, MLFX) Alarm

- 
- Step 1** Verify that the LAN cable is properly connected and attached to the correct port on the ML-Series card and on the peer Ethernet port. For more information about fiber connections and terminations, refer to the “Install Cards and Fiber-Optic Cable” chapter in the *Cisco ONS 15454 Procedure Guide*.
- Step 2** If the alarm does not clear, verify that autonegotiation is set properly on the ML-Series card port and the peer Ethernet port.
- Step 3** If the alarm does not clear, verify that the speed is set properly on the ML-Series card port and the peer Ethernet port if you are using 10/100 ports.
- Step 4** If the alarm does not clear, the Ethernet signal is not valid, but the transmitting device is operational, replace the LAN cable connecting the transmitting device to the Ethernet port.
- Step 5** If the alarm does not clear, disable and reenble the Ethernet port by performing a “shutdown” and then a “no shutdown” on the Cisco IOS CLI as in the following example:
- ```
router(config)# shut
router(config)# no shut
```
- This action restarts autonegotiation.
- Step 6** If the alarm does not clear, complete the “[Create the Facility Loopback on the Source DS-1, DS-3, DS3N-12, DS3i-N-12, or EC1 Port](#)” procedure on page 1-10 and test the loopback.
- Step 7** If the problem persists with the loopback installed, complete the “[Remove and Reinsert \(Reseat\) Any Card](#)” procedure on page 2-274.
- Step 8** If the alarm does not clear, complete the “[Physically Replace a Traffic Card](#)” procedure on page 2-274.
- Step 9** If the alarm does not clear, log into the Technical Support Website at <http://www.cisco.com/techsupport> for more information or call Cisco TAC 1 800 553-2447 in order to report a Service-Affecting (SA) problem.
-

2.7.56 CARLOSS (TRUNK)

For information about this alarm or condition, refer to the “Alarm Troubleshooting” chapter in the *Cisco ONS 15454 DWDM Troubleshooting Guide*. This guide discusses all DWDM alarms.

2.7.57 CASETEMP-DEG

For information about this alarm or condition, refer to the “Alarm Troubleshooting” chapter in the *Cisco ONS 15454 DWDM Troubleshooting Guide*. This guide discusses all DWDM alarms.

2.7.58 CLDRESTART

Default Severity: Not Alarmed (NA), Non-Service-Affecting (NSA)

SONET Logical Object: EQPT

The Cold Restart condition occurs when a card is physically removed and inserted, replaced, or when the ONS 15454 power is initialized.

Clear the CLDRESTART Condition

-
- Step 1** Complete the “[Remove and Reinsert \(Reseat\) the Standby TCC2/TCC2P Card](#)” procedure on [page 2-273](#).
 - Step 2** If the condition fails to clear after the card reboots, complete the “[Remove and Reinsert \(Reseat\) Any Card](#)” procedure on [page 2-274](#).
 - Step 3** If the condition does not clear, complete the “[Physically Replace a Traffic Card](#)” procedure on [page 2-274](#) for the card.
 - Step 4** If the condition does not clear, log into the Technical Support Website at <http://www.cisco.com/techsupport> for more information or call Cisco TAC 1 800 553-2447.
-

2.7.59 COMIOXC

Default Severity: Critical (CR), Service-Affecting (SA)

SONET Logical Object: EQPT

The Input/Output Slot To Cross-Connect Communication Failure alarm is caused by the XC10G or XC-VXC-10G cross-connect card when there is a communication failure for a traffic slot.

Clear the COMIOXC Alarm

-
- Step 1** Complete the “[Reset a Traffic Card in CTC](#)” procedure on [page 2-271](#) on the card in which the alarm is reported. For the LED behavior, see the “[2.8.2 Typical Traffic Card LED Activity During Reset](#)” section on [page 2-260](#).

- Step 2** Verify that the reset is complete and error-free and that no new related alarms appear in CTC. A green ACT/SBY LED indicates an active card. An amber ACT/SBY LED indicates a standby card.
 - Step 3** If the CTC reset does not clear the alarm, move traffic off the reporting cross-connect card. Complete the “[Side Switch the Active and Standby Cross-Connect Cards](#)” procedure on page 2-272.
 - Step 4** Complete the “[Remove and Reinsert \(Reseat\) Any Card](#)” procedure on page 2-274 on the card in which the alarm is reported.
 - Step 5** If the alarm does not clear, complete the “[Physically Replace an In-Service Cross-Connect Card](#)” procedure on page 2-274 for the reporting cross-connect card or complete the “[Physically Replace a Traffic Card](#)” procedure on page 2-274 on the card in which the alarm is reported.
 - Step 6** If the alarm does not clear, log into the Technical Support Website at <http://www.cisco.com/techsupport> for more information or call Cisco TAC 1 800 553-2447 in order to report a Service-Affecting (SA) problem.
-

2.7.60 COMM-FAIL

Default Severity: Minor (MN), Non-Service-Affecting (NSA)

SONET Logical Object: EQPT

The Plug-In Module (card) Communication Failure indicates that there is a communication failure between the TCC2/TCC2P and the traffic card. The failure could indicate a broken card interface.

Clear the COMM-FAIL Alarm

- Step 1** Complete the “[Reset a Traffic Card in CTC](#)” procedure on page 2-271 for the reporting card.
 - Step 2** If the alarm does not clear, complete the “[Physically Replace a Traffic Card](#)” procedure on page 2-274 for the card.
 - Step 3** If the condition does not clear, log into the Technical Support Website at <http://www.cisco.com/techsupport> for more information or call Cisco TAC 1 800 553-2447.
-

2.7.61 CONTBUS-A-18

Default Severity: Minor (MN), Non-Service-Affecting (NSA)

SONET Logical Object: EQPT

A Communication Failure from Controller Slot to Controller Slot alarm for the TCC2/TCC2P slot to TCC2/TCC2P slot occurs when the main processor on the TCC2/TCC2P in the first slot (TCC A) loses communication with the coprocessor on the same card. This applies to the TCC2/TCC2P in Slot 7.

Clear the CONTBUS-A-18 Alarm

- Step 1** Complete the “[Remove and Reinsert \(Reseat\) the Standby TCC2/TCC2P Card](#)” procedure on page 2-273 to make the TCC2/TCC2P in Slot 11 active.

- Step 2** Wait approximately 10 minutes for the TCC2/TCC2P in Slot 7 to reset as the standby TCC2/TCC2P. Verify that the ACT/SBY LED is correctly illuminated before proceeding to the next step. A green ACT/SBY LED indicates an active card. An amber ACT/SBY LED indicates a standby card.
- Step 3** Position the cursor over the TCC2/TCC2P in Slot 11 and complete the [“Reset an Active TCC2/TCC2P Card and Activate the Standby Card” procedure on page 2-271](#) to return the card to the active state.
- Step 4** If the reset card has not rebooted successfully, or the alarm has not cleared, call Cisco TAC (1-800-553-2447). If the Cisco TAC technician tells you to reseat the card, complete the [“Reset an Active TCC2/TCC2P Card and Activate the Standby Card” procedure on page 2-271](#). If the Cisco TAC technician tells you to remove the card and reinstall a new one, follow the [“Physically Replace a Traffic Card” procedure on page 2-274](#).
-

2.7.62 CONTBUS-B-18

Default Severity: Minor (MN), Non-Service-Affecting (NSA)

SONET Logical Object: EQPT

A Communication Failure from Controller Slot to Controller Slot alarm for the TCC2/TCC2P slot to TCC2/TCC2P slot occurs when the main processor on the TCC2/TCC2P in the second slot (TCC B) loses communication with the coprocessor on the same card. This applies to the Slot 11 TCC2/TCC2P.

Clear the CONTBUS-B-18 Alarm

- Step 1** Complete the [“Reset an Active TCC2/TCC2P Card and Activate the Standby Card” procedure on page 2-271](#) to make the Slot 7 TCC2/TCC2P active.
- Step 2** Wait approximately 10 minutes for the Slot 11 TCC2/TCC2P to reset as the standby TCC2/TCC2P. Verify that the ACT/SBY LED is correctly illuminated before proceeding to the next step. A green ACT/SBY LED indicates an active card. An amber ACT/SBY LED indicates a standby card.
- Step 3** Position the cursor over the Slot 7 TCC2/TCC2P and complete the [“Reset an Active TCC2/TCC2P Card and Activate the Standby Card” procedure on page 2-271](#) to return the Slot 11 TCC2/TCC2P to the active state.
- Step 4** If the reset card has not rebooted successfully, or the alarm has not cleared, call Cisco TAC (1-800-553-2447). If the Cisco TAC technician tells you to reseat the card, complete the [“Remove and Reinsert \(Reseat\) the Standby TCC2/TCC2P Card” procedure on page 2-273](#). If the Cisco TAC technician tells you to remove the card and reinstall a new one, follow the [“Physically Replace a Traffic Card” procedure on page 2-274](#).
-

2.7.63 CONTBUS-DISABLED

Default Severity: Critical (CR), Service-Affecting (SA)

SONET Logical Object: EQPT

The CONTBUS-DISABLED alarm is a function of the enhanced cell bus verification feature. This alarm occurs when a defective card is installed in the shelf assembly or when a card already installed in the shelf assembly becomes defective (that is, the card fails the enhanced cell bus verification test). The

alarm persists as long as the defective card remains in the chassis. When the card is removed, CONTBUS-DISABLED will remain raised for a one-minute wait time. This wait time is designed as a guard period so that the system can distinguish this outage from a briefer card reset communication outage.

If no card is reinserted into the original slot during the wait time, the alarm clears. After this time, a different, non-defective card (not the original card) should be inserted.

When CONTBUS-DISABLED is raised, no message-oriented communication is allowed to or from this slot to the TCC2/TCC2P (thus avoiding node communication failure).

Caution

CONTBUS-DISABLED clears only when the faulty card is removed for one minute. If any card at all is reinserted before the one-minute guard period expires, the alarm does not clear.

CONTBUS-DISABLED overrides the “[IMPROPRMVL](#)” alarm on page 2-128 during the one-minute wait period, but afterward IMPROPRMVL can be raised because it is no longer suppressed. IMPROPRMVL is raised after CONTBUS-DISABLED clears if the card is in the node database. If CONTBUS-DISABLED has cleared but IMPROPRMVL is still active, inserting a card will clear the IMPROPRMVL alarm.

Clear the CONTBUS-DISABLED Alarm

-
- Step 1** If the IMPROPRMVL alarm is raised, complete the “[Physically Replace a Traffic Card](#)” procedure on page 2-274. (For general information about card installation, refer to the “Install Cards and Fiber-Optic Cable” chapter in the *Cisco ONS 15454 Procedure Guide*.)
- Step 2** If the alarm does not clear, log into the Technical Support Website at <http://www.cisco.com/techsupport> for more information or call Cisco TAC 1 800 553-2447 to report a Service-Affecting (SA) problem.
-

2.7.64 CONTBUS-IO-A

Default Severity: Minor (MN), Non-Service-Affecting (NSA)

SONET Logical Object: EQPT

A TCCA to Shelf A Slot Communication Failure alarm occurs when the active Slot 7 TCC2/TCC2P (TCC A) has lost communication with another card in the shelf. The other card is identified by the Object column in the CTC alarm window.

The CONTBUS-IO-A alarm can appear briefly when the ONS 15454 switches to the protect TCC2/TCC2P. In the case of a TCC2/TCC2P protection switch, the alarm clears after the other cards establish communication with the newly active TCC2/TCC2P. If the alarm persists, the problem lies with the physical path of communication from the TCC2/TCC2P to the reporting card. The physical path of communication includes the TCC2/TCC2P, the other card, and the backplane.

Clear the CONTBUS-IO-A Alarm

-
- Step 1** Ensure that the reporting card is physically present in the shelf. Record the card type. Click the **Inventory** tab and view the Eqpt Type column to reveal the provisioned type.

If the actual card type and the provisioned card type do not match, see the “[MEA \(EQPT\)](#)” alarm on [page 2-183](#) for the reporting card.

- Step 2** If the alarm object is any single card slot other than the standby Slot 11 TCC2/TCC2P, perform a CTC reset of the object card. Complete the “[Reset a Traffic Card in CTC](#)” procedure on [page 2-271](#). For the LED behavior, see the “[2.8.2 Typical Traffic Card LED Activity During Reset](#)” section on [page 2-260](#).
- Step 3** If the alarm object is the standby Slot 11 TCC2/TCC2P, complete the “[Reset a Traffic Card in CTC](#)” procedure on [page 2-271](#) for it. The procedure is similar.
- Wait ten minutes to verify that the card you reset completely reboots and becomes the standby card. (A reset standby card remains standby.)
- If CONTBUS-IO-A is raised on several cards at the same time, complete the “[Reset an Active TCC2/TCC2P Card and Activate the Standby Card](#)” procedure on [page 2-271](#).
- Wait ten minutes to verify that the card you reset completely reboots and becomes the standby card.
- Step 4** Verify that the reset is complete and error-free and that no new related alarms appear in CTC. A green ACT/SBY LED indicates an active card. An amber ACT/SBY LED indicates a standby card.
- Step 5** If the CTC reset does not clear the alarm, complete the “[Remove and Reinsert \(Reseat\) Any Card](#)” procedure on [page 2-274](#) for the reporting card.
- Step 6** If the reset card has not rebooted successfully, or the alarm has not cleared, call Cisco TAC 1 800 553-2447. If the Cisco TAC technician tells you to reseat the card, complete the “[Remove and Reinsert \(Reseat\) the Standby TCC2/TCC2P Card](#)” procedure on [page 2-273](#). If the Cisco TAC technician tells you to remove the card and reinstall a new one, follow the “[Physically Replace a Traffic Card](#)” procedure on [page 2-274](#).
-

2.7.65 CONTBUS-IO-B

Default Severity: Minor (MN), Non-Service-Affecting (NSA)

SONET Logical Object: EQPT

A TCC B to Shelf Communication Failure alarm occurs when the active Slot 11 TCC2/TCC2P (TCC B) has lost communication with another card in the shelf. The other card is identified by the Object column in the CTC alarm window.

The CONTBUS-IO-B alarm could appear briefly when the ONS 15454 switches to the protect TCC2/TCC2P. In the case of a TCC2/TCC2P protection switch, the alarm clears after the other cards establish communication with the newly active TCC2/TCC2P. If the alarm persists, the problem lies with the physical path of communication from the TCC2/TCC2P to the reporting card. The physical path of communication includes the TCC2/TCC2P, the other card, and the backplane.

Clear the CONTBUS-IO-B Alarm

- Step 1** Ensure that the reporting card is physically present in the shelf. Record the card type. Click the **Inventory** tab and view the Eqpt Type column to reveal the provisioned type.
- If the actual card type and the provisioned card type do not match, see the “[MEA \(EQPT\)](#)” alarm on [page 2-183](#) for the reporting card.

- Step 2** If the alarm object is any single card slot other than the standby Slot 7 TCC2/TCC2P, perform a CTC reset of the object card. Complete the [“Reset a Traffic Card in CTC” procedure on page 2-271](#). For the LED behavior, see the [“2.8.2 Typical Traffic Card LED Activity During Reset” section on page 2-260](#).
- Step 3** If the alarm object is the standby Slot 7 TCC2/TCC2P, complete the [“Reset a Traffic Card in CTC” procedure on page 2-271](#) for it. The procedure is similar.
- Wait ten minutes to verify that the card you reset completely reboots and becomes the standby card. (A reset standby card remains standby.)
- Step 4** If CONTBUS-IO-B is raised on several cards at the same time, complete the [“Reset an Active TCC2/TCC2P Card and Activate the Standby Card” procedure on page 2-271](#).
- Wait ten minutes to verify that the card you reset completely reboots and becomes the standby card.
- Step 5** Verify that the reset is complete and error-free and that no new related alarms appear in CTC. A green ACT/SBY LED indicates an active card. An amber ACT/SBY LED indicates a standby card.
- Step 6** If the CTC reset does not clear the alarm, complete the [“Remove and Reinsert \(Reseat\) Any Card” procedure on page 2-274](#) for the reporting card.
- Step 7** If the reset card has not rebooted successfully, or the alarm has not cleared, call Cisco TAC 1 800 553-2447. If the Cisco TAC technician tells you to reseat the card, complete the [“Remove and Reinsert \(Reseat\) the Standby TCC2/TCC2P Card” procedure on page 2-273](#). If the Cisco TAC technician tells you to remove the card and reinstall a new one, follow the [“Physically Replace a Traffic Card” procedure on page 2-274](#).

2.7.66 CPP-INCAPABLE

Default Severity: Not Alarmed (NA), Non-Service-Affecting (NSA)

SONET Logical Object: EQPT

The Card Port Protection Incapable alarm indicates that the ML-MR-10 card or port is unable to provide protection. This condition occurs when the Resilient Packet Ring (RPR) interface on the ML-MR-10 card is down, or when the CPP peer slot number is not configured from the Cisco IOS command line interface.



Note

For information about provisioning ML-MR-10 Ethernet cards from the Cisco IOS interface, refer to the *Cisco ONS 15454 and Cisco ONS 15454 SDH Ethernet Card Software Feature and Configuration Guide*.

Clear the CPP-INCAPABLE Alarm

- Step 1** Ensure that the RPR interface is not in the administratively shutdown state.
- Step 2** Ensure that the RPR interface is in the line protocol UP state.
- Step 3** Ensure that the CPP peer slot is configured in Cisco IOS under the protection group configuration.
- Step 4** If the condition does not clear, log into the Technical Support Website at <http://www.cisco.com/techsupport> for more information or call Cisco TAC 1 800 553-2447.

2.7.67 CTNEQPT-MISMATCH

Default Severity: Not Alarmed (NA), Non-Service-Affecting (NSA)

SONET Logical Object: EQPT

The Connection Equipment Mismatch condition is raised when there is a mismatch between the cross-connect card pre-provisioned in the slot and the card actually installed in the shelf. For example, one type of cross-connect card could be pre-provisioned in Slot 10, but another could be physically installed. It can also be caused by a card that is mismatched with the card. For example, CTNEQPT-MISMATCH is raised when an XCVT card is replaced with a XC10G card.

Cisco does not support configurations of unmatched cross-connect cards in Slot 8 and Slot 10, although this situation could briefly occur during the upgrade process.

The cross-connect card you are replacing should not be the active card. (It can be in SBY state or otherwise not in use.)



Note

During an upgrade, this condition occurs and is raised as its default severity, Not Alarmed (NA). However, after the upgrade has occurred, if you wish to change the condition's severity so that it is Not Reported (NR), you can do this by modifying the alarm profile used at the node. For more information about modifying alarm severities, refer to the "Manage Alarms" chapter in the *Cisco ONS 15454 Procedure Guide*.

Clear the CTNEQPT-MISMATCH Condition

-
- Step 1** Determine what kind of card is pre-provisioned in the slot:
- In node view, click the **Inventory** tab.
 - View the information for the slot in the **Eqpt Type** and **Actual Eqpt Type** columns.
The Eqpt Type column contains the equipment that is provisioned in the slot. The Actual Eqpt Type contains the equipment that is physically present in the slot. For example, Slot 8 could be provisioned for an XCVT card, which is shown in the Eqpt Type column, but an XC10G XC10G card could be physically present in the slot. The XC10G would be shown in the Actual Eqpt Type column.
- Step 2** Complete the "[Physically Replace a Traffic Card](#)" procedure on page 2-274 for the mismatched card.
- Step 3** If the condition does not clear, log onto <http://www.cisco.com/techsupport> for more information or call Cisco TAC 1 800 553-2447.
-

2.7.68 CTNEQPT-PBPROT

Default Severity: Critical (CR), Service-Affecting (SA)

SONET Logical Object: EQPT

The Interconnection Equipment Failure Protect Cross-Connect Card Payload Bus Alarm indicates a failure of the main payload between the protect ONS 15454 Slot 10 XC10G card and the reporting traffic card. The cross-connect card and the reporting card are no longer communicating through the backplane. The problem exists in the cross-connect card and the reporting traffic card, or the TCC2/TCC2P and the backplane.

**Note**

This alarm automatically raises and clears when the Slot 8 XC10G card is reseated.

**Caution**

A software update on a standby TCC2/TCC2P can take up to 30 minutes.

Clear the CTNEQPT-PBPROT Alarm

- Step 1** If all traffic cards show CTNEQPT-PBPROT alarm, complete the following steps:
- Complete the [“Remove and Reinsert \(Reseat\) the Standby TCC2/TCC2P Card”](#) procedure on page 2-273 for the standby TCC2/TCC2P.
 - If the reseat fails to clear the alarm, complete the [“Physically Replace a Traffic Card”](#) procedure on page 2-274 for the standby TCC2/TCC2P.

**Caution**

Do not physically reseat an active TCC2/TCC2P. Doing so disrupts traffic.

- Step 2** If not all cards show the alarm, perform a CTC reset on the standby XC10G card. Complete the [“Reset a Traffic Card in CTC”](#) procedure on page 2-271. For the LED behavior, see the [“2.8.2 Typical Traffic Card LED Activity During Reset”](#) section on page 2-260.
- Step 3** Verify that the reset is complete and error-free and that no new related alarms appear in CTC. A green ACT/SBY LED indicates an active card. An amber ACT/SBY LED indicates a standby card.
- If the cross-connect reset is not complete and error-free or if the TCC2/TCC2P reboots automatically, call Cisco TAC 1 800 553-2447.
- Step 4** If the alarm does not clear, complete the [“Remove and Reinsert \(Reseat\) Any Card”](#) procedure on page 2-274 for the standby OC-192 card.
- Step 5** Determine whether the card is an active card or standby card in a protection group. Click the node view **Maintenance > Protection** tabs, then click the protection group. The cards and their status are displayed in the list.
- Step 6** If the reporting traffic card is the active card in the protection group, complete the [“Initiate a 1:1 Card Switch Command”](#) procedure on page 2-265. After you move traffic off the active card, or if the reporting card is standby, continue with the following steps.
- Step 7** Complete the [“Reset a Traffic Card in CTC”](#) procedure on page 2-271 on the reporting card. For the LED behavior, see the [“2.8.2 Typical Traffic Card LED Activity During Reset”](#) section on page 2-260.
- Step 8** Verify that the reset is complete and error-free and that no new related alarms appear in CTC. A green ACT/SBY LED indicates an active card. An amber ACT/SBY LED indicates a standby card.
- Step 9** If the alarm does not clear, complete the [“Remove and Reinsert \(Reseat\) Any Card”](#) procedure on page 2-274 for the reporting card.
- Step 10** Complete the [“Initiate a 1:1 Card Switch Command”](#) procedure on page 2-265 to switch traffic back.

- Step 11** If the alarm does not clear, complete the [“Physically Replace a Traffic Card” procedure on page 2-274](#) for the reporting traffic card.
- Step 12** If the alarm does not clear, log into the Technical Support Website at <http://www.cisco.com/techsupport> for more information or call Cisco TAC 1 800 553-2447 in order to report a Service-Affecting (SA) problem.

2.7.69 CTNEQPT-PBWORK

Default Severity: Critical (CR), Service-Affecting (SA)

SONET Logical Object: EQPT

The Interconnection Equipment Failure Working Cross-Connect Card Payload Bus alarm indicates a failure in the main payload bus between the ONS 15454 Slot 8 XC10G card and the reporting traffic card. The cross-connect card and the reporting card are no longer communicating through the backplane. The problem exists in the cross-connect card and the reporting traffic card, or the TCC2/TCC2P and the backplane.



Note

This alarm automatically raises and clears when the ONS 15454 Slot 10 XC10G card is reset.

Clear the CTNEQPT-PBWORK Alarm

- Step 1** If all traffic cards show CTNEQPT-PBWORK alarm, complete the following steps:
- Complete the [“Reset an Active TCC2/TCC2P Card and Activate the Standby Card” procedure on page 2-271](#) for the active TCC2/TCC2P and then complete the [“Remove and Reinsert \(Reseat\) the Standby TCC2/TCC2P Card” procedure on page 2-273](#).
 - If the reseat fails to clear the alarm, complete the [“Physically Replace a Traffic Card” procedure on page 2-274](#) for the TCC2/TCC2P.



Caution

Always use the supplied electrostatic discharge wristband when working with a powered ONS 15454. Plug the wristband cable into the ESD jack located on the lower-right edge of the shelf assembly.



Caution

Do not physically reseat an active TCC2/TCC2P; it disrupts traffic.

- Step 2** If all cards do not show the alarm, complete the [“Side Switch the Active and Standby Cross-Connect Cards” procedure on page 2-272](#) for the active XC10G card.
- Step 3** Complete the [“Reset a Traffic Card in CTC” procedure on page 2-271](#) for the reporting card. For the LED behavior, see the [“2.8.2 Typical Traffic Card LED Activity During Reset” section on page 2-260](#).
- Step 4** Verify that the reset is complete and error-free and that no new related alarms appear in CTC. A green ACT/SBY LED indicates an active card. An amber ACT/SBY LED indicates a standby card.
- Step 5** If the alarm does not clear, complete the [“Remove and Reinsert \(Reseat\) Any Card” procedure on page 2-274](#) for the standby cross-connect card.

- Step 6** If the alarm does not clear and the reporting traffic card is the active card in the protection group, complete the [“Initiate a 1:1 Card Switch Command” procedure on page 2-265](#). If the card is standby, or if you have moved traffic off the active card, proceed with the following steps.
- Step 7** Complete the [“Reset a Traffic Card in CTC” procedure on page 2-271](#) for the reporting card. For the LED behavior, see the [“2.8.2 Typical Traffic Card LED Activity During Reset” section on page 2-260](#).
- Step 8** Verify that the reset is complete and error-free and that no new related alarms appear in CTC. A green ACT/SBY LED indicates an active card. An amber ACT/SBY LED indicates a standby card.
- Step 9** If the CTC reset does not clear the alarm, complete the [“Remove and Reinsert \(Reseat\) Any Card” procedure on page 2-274](#) for the reporting card.
- Step 10** If you switched traffic, complete the [“Initiate a 1:1 Card Switch Command” procedure on page 2-265](#) to revert the traffic.
- Step 11** If the alarm does not clear, complete the [“Physically Replace a Traffic Card” procedure on page 2-274](#) for the OC-192 card.
- Step 12** If the alarm does not clear, complete the [“Physically Replace a Traffic Card” procedure on page 2-274](#) for the reporting traffic card.
- Step 13** If the alarm does not clear, log into the Technical Support Website at <http://www.cisco.com/techsupport> for more information or call Cisco TAC 1 800 553-2447 in order to report a Service-Affecting (SA) problem.

2.7.70 DATA-CRC

Default Severity: Major (MJ), Service-Affecting (SA)

SONET Logical Objects: CE100T, ML100T, ML1000, MLFX

The data cyclic redundancy check (CRC) Bad Packet Count Exceeds Threshold alarm indicates that Cisco proprietary ring-wrapping (RPR) has been triggered for an ML-Series card in high-level data link (HDLC) mode, but no SONET or data-level alarm is raised along with the [“RPRW” alarm on page 2-216](#) to indicate the failure.

In a typical scenario that triggers Cisco proprietary RPR protection, the errored node raises RPRW, and SONET or data errors such as the [“TPTFAIL \(ML100T, ML1000, MLFX\)” alarm on page 2-250](#). If, however, a packet-over-SONET (POS) port is placed in down administrative state, the card will raise an RPRW without raising any SONET B3 bit alarms or data alarms. The DATA-CRC alarm accompanies this instance of RPRW to indicate the signal interruption.

Clear the DATA-CRC Alarm

- Step 1** Determine whether the [“RPRW” alarm on page 2-216](#), is raised on the ring. If so, clear it using the appropriate trouble-clearing procedure in this chapter.
- Step 2** If the DATA-CRC alarm does not clear, check whether the alarmed card POS port is in the Down administrative state:
- Double-click the ML-Series card to display the card view.
 - Click the **Provisioning > POS Ports** tabs.

- c. View the port's setting in the Admin State column. If it is Down, verify that both POS ports are properly configured. Refer to the *Cisco ONS 15454 and Cisco ONS 15454 SDH Ethernet Card Software Feature and Configuration Guide* for configuration information.
- Step 3** If the alarm does not clear, log into the Technical Support Website at <http://www.cisco.com/techsupport> for more information or call Cisco TAC 1 800 553-2447 in order to report a Service-Affecting (SA) problem.
-

2.7.71 DATAFLT

Default Severity: Minor (MN), Non-Service-Affecting (NSA)

SONET Logical Object: NE

The Software Data Integrity Fault alarm occurs when the TCC2/TCC2P exceeds its flash memory capacity.



Caution

When the system reboots, the last configuration entered is not saved.

Clear the DATAFLT Alarm

- Step 1** Complete the [“Reset an Active TCC2/TCC2P Card and Activate the Standby Card” procedure on page 2-271](#).
- Step 2** If the alarm does not clear, log into the Technical Support Website at <http://www.cisco.com/techsupport> for more information or call Cisco TAC 1 800 553-2447.
-

2.7.72 DBOSYNC

Default Severity: Major (MJ), Service-Affecting (SA)

SONET Logical Object: NE

The Standby Database Out Of Synchronization alarm occurs when the standby TCC2/TCC2P database does not synchronize with the active database on the active TCC2/TCC2P.



Caution

If you reset the active TCC2/TCC2P while this alarm is raised, you lose current provisioning.

Clear the DBOSYNC Alarm

- Step 1** Save a backup copy of the active TCC2/TCC2P database. Refer to the “Maintain the Node” chapter in the *Cisco ONS 15454 Procedure Guide* for procedures.
- Step 2** Make a minor provisioning change to the active database to see if applying a provisioning change clears the alarm:
- a. In node view, click the **Provisioning > General > General** tabs.

- b. In the Description field, make a small change such as adding a period to the existing entry.

The change causes a database write but does not affect the node state. The write could take up to a minute.

- Step 3** If the alarm does not clear, log into the Technical Support Website at <http://www.cisco.com/techsupport> for more information or call Cisco TAC 1 800 553-2447.
-

2.7.73 DCU-LOSS-FAIL

For information about this alarm or condition, refer to the “Alarm Troubleshooting” chapter in the *Cisco ONS 15454 DWDM Troubleshooting Guide*. This guide discusses all DWDM alarms.

2.7.74 DISCONNECTED

Default Severity: Minor (MN), Non-Service-Affecting (NSA)

SONET Logical Object: SYSTEM

The Disconnected alarm is raised when CTC has been disconnected from the node. The alarm clears when CTC reconnects to the node.

Clear the DISCONNECTED Alarm

-
- Step 1** Restart CTC.

- Step 2** If the alarm does not clear, log into the Technical Support Website at <http://www.cisco.com/techsupport> for more information or call TAC (1-800-553-2447).
-

2.7.75 DS3-MISM

Default Severity: Not Alarmed (NA), Non-Service-Affecting (NSA)

SONET Logical Object: DS3

The DS-3 Frame Format Mismatch condition indicates a frame format mismatch on a signal transiting the ONS 15454 DS3XM-6, DS3XM-12, or DS3/EC1-48 card. The condition occurs when the provisioned line type and incoming signal frame format type do not match. For example, if the line type for a DS3XM-6 card is set to C Bit and the incoming signal frame format is detected as M13, then the ONS 15454 reports a DS3-MISM condition.

Clear the DS3-MISM Condition

-
- Step 1** Display the CTC card view for the reporting DS3E-12, DS3I-12, DS3XM-6, DS3XM-12, or DS3/EC1-48 card.

- Step 2** Click the **Provisioning > Line** tabs.

- Step 3** For the row on the appropriate port, verify that the Line Type column is set to match the expected incoming signal (C Bit or M13).
- Step 4** If the Line Type field does not match the expected incoming signal, select the correct Line Type in the drop-down list.
- Step 5** Click **Apply**.
- Step 6** If the condition does not clear after the user verifies that the provisioned line type matches the expected incoming signal, use an optical test set to verify that the actual signal coming into the ONS 15454 matches the expected incoming signal. For specific procedures to use the test set equipment, consult the manufacturer.
- Step 7** If the condition does not clear, log into the Technical Support Website at <http://www.cisco.com/techsupport> for more information or call Cisco TAC 1 800 553-2447.
-

2.7.76 DSP-COMM-FAIL

For information about this alarm or condition, refer to the “Alarm Troubleshooting” in the *Cisco ONS 15454 DWDM Troubleshooting Guide*. This guide discusses all DWDM alarms.

2.7.77 DSP-FAIL

For information about this alarm or condition, refer to the “Alarm Troubleshooting” chapter in the *Cisco ONS 15454 DWDM Troubleshooting Guide*. This guide discusses all DWDM alarms.

2.7.78 DUP-IPADDR

Default Severity: Minor (MN), Non-Service Affecting (NSA)

SONET Logical Object: NE

The Duplicate IP Address alarm indicates that the alarmed node IP address is already in use within the same DCC area. When this happens, CTC no longer reliably connects to either node. Depending on how the packets are routed, CTC could connect to either node (having the same IP address). If CTC has connected to both nodes before they shared the same address, it has two distinct NodeModel instances (keyed by the node ID portion of the MAC address).

Clear the DUP-IPADDR Alarm

- Step 1** Isolate the alarmed node from the other node having the same address:
- Connect to the alarmed node using the Craft port on the TCC2/TCC2P card.
 - Begin a CTC session.
 - In the login dialog window, uncheck the **Network Discovery** check box.
- Step 2** In node view, click the **Provisioning > Network > General** tabs.
- Step 3** In the IP Address field, change the IP address to a unique number.
- Step 4** Click **Apply**.

- Step 5** Restart any CTC sessions that are logged into either of the duplicate IP addresses. (For procedures to log in or log out, refer to the “Connect the PC and Log Into the GUI” chapter in the *Cisco ONS 15454 Procedure Guide*.
- Step 6** If the alarm does not clear, log into the Technical Support Website at <http://www.cisco.com/techsupport> for more information or call Cisco TAC 1 800 553-2447.
-

2.7.79 DUP-NODENAME

Default Severity: Minor (MN), Non-Service-Affecting (NSA)

SONET Logical Object: NE

The Duplicate Node Name alarm indicates that the alarmed node alphanumeric name is already being used within the same DCC area.

Clear the DUP-NODENAME Alarm

- Step 1** In node view, click the **Provisioning > General > General** tabs.
- Step 2** In the Node Name/TID field, enter a unique name for the node.
- Step 3** Click **Apply**.
- Step 4** If the alarm does not clear, log into the Technical Support Website at <http://www.cisco.com/techsupport> for more information or call Cisco TAC 1 800 553-2447.
-

2.7.80 DUP-SHELF-ID

For information about this alarm or condition, refer to the “Alarm Troubleshooting” chapter in the *Cisco ONS 15454 DWDM Troubleshooting Guide*. This guide discusses all DWDM alarms.

2.7.81 EHIBATVG

Default Severity: Major (MJ), Service-Affecting (SA)

SONET Logical Object: PWR

The Extreme High Voltage Battery alarm occurs in a –48 VDC environment when a battery lead input voltage exceeds the extreme high power threshold. This threshold, with a default value of –56.5 VDC, is user-provisionable. The alarm remains raised until the voltage remains under the threshold for 120 seconds.

Clear the EHIBATVG Alarm

- Step 1** The problem is external to the ONS 15454. Troubleshoot the power source supplying the battery leads.

- Step 2** If the alarm does not clear, log into the Technical Support Website at <http://www.cisco.com/techsupport> for more information or call Cisco TAC 1 800 553-2447 in order to report a Service-Affecting (SA) problem.
-

2.7.82 ELWBATVG

Default Severity: Major (MJ), Service-Affecting (SA)

SONET Logical Object: PWR

The Extreme Low Voltage Battery alarm occurs in a –48 VDC environment when a battery lead input voltage falls below the extreme low power threshold. This threshold, with a default value of –40.5 VDC, is user-provisionable. The alarm remains raised until the voltage remains over the threshold for 120 seconds.

Clear the ELWBATVG Alarm

- Step 1** The problem is external to the ONS 15454. Troubleshoot the power source supplying the battery leads.
- Step 2** If the alarm does not clear, log into the Technical Support Website at <http://www.cisco.com/techsupport> for more information or call Cisco TAC 1 800 553-2447 in order to report a Service-Affecting (SA) problem.
-

2.7.83 ENCAP-MISMATCH-P

Default Severity: Critical (CR), Service-Affecting (SA)

SONET Logical Object: STSTRM

The Encapsulation C2 Byte Mismatch Path alarm applies to ML-Series Ethernet cards or the CE-1000 card. It occurs when the first three following conditions are met and one of the last two is false:

- The received C2 byte is not 0x00 (unequipped).
- The received C2 byte is not a PDI value.
- The received C2 does not match the expected C2.
- The expected C2 byte is not 0x01 (equipped unspecified).
- The received C2 byte is not 0x01 (equipped unspecified).

(This is in contrast to the “PLM-P” alarm on page 2-196, which must meet all five criteria.) For an ENCAP-MISMATCH-P to be raised, there is a mismatch between the received and expected C2 byte, with either the expected byte or received byte value being 0x01.

For example, an ENCAP-MISMATCH-P alarm is raised if a circuit created between two ML-Series or two CE-1000 cards has generic framing procedure (GFP) framing provisioned on one end and HDLC framing with LEX encapsulation provisioned on the other. The GFP framing card transmits and expects a C2 byte of 0x1B, while the HDLC framing card transmits and expects a C2 byte of 0x01.

A mismatch between the transmit and receive cards on any of the following parameters can cause the alarm:

- Mode (HDLC, GFP-F)
- Encapsulation (LEX, HDLC, PPP)
- CRC size (16 or 32)
- Scrambling state (on or off)

This alarm is demoted by a “PLM-P” condition on page 2-196 or a “PLM-V” condition on page 2-197.

**Note**

By default, an ENCAP-MISMATCH-P alarm causes an ML-Series or CE-1000 card data link to go down. This behavior can be modified using the command line interface (CLI) command in interface configuration mode: **no pos trigger defect encap**.

**Note**

For more information about the ML-Series or CE-1000 Ethernet cards, refer to the *Cisco ONS 15454 and Cisco ONS 15454 SDH Ethernet Card Software Feature and Configuration Guide*.

Clear the ENCAP-MISMATCH-P Alarm

-
- Step 1** Ensure that the correct framing mode is in use on the receive card:
- In node view, double-click the receive ML-Series or CE-1000 card to open the card view.
 - Click the **Provisioning > Card** tabs.
 - In the Mode drop-down list, ensure that the same mode (GFP or HDLC) is selected. If it is not, choose it and click **Apply**.
- Step 2** Ensure that the correct framing mode is in use on the transmit card, and that it is identical to the receiving card:
- In node view, double-click the transmit ML-Series or CE-1000 card to open the card view.
 - Click the **Provisioning > Card** tabs.
 - In the Mode drop-down list, ensure that the same mode (GFP or HDLC) is selected. If it is not, choose it and click **Apply**.
- Step 3** If the alarm does not clear, use the CLI to ensure that the remaining settings are correctly configured on the ML-Series or CE-1000 card:
- Encapsulation
 - CRC size
 - Scrambling state
- To open the interface, click the **IOS** tab and click **Open IOS Command Line Interface (CLI)**. Refer to the *Cisco ONS 15454 and Cisco ONS 15454 SDH Ethernet Card Software Feature and Configuration Guide* entries on all three of these topics to obtain the full configuration command sequences.
- Step 4** If the alarm does not clear, log into the Technical Support Website at <http://www.cisco.com/techsupport> for more information or call Cisco TAC 1 800 553-2447 in order to report a Service-Affecting (SA) problem.
-

2.7.84 EOC

Default Severity: Minor (MN), Non-Service-Affecting (NSA)

SONET Logical Object: OCN

DWDM Logical Object: TRUNK

The SONET DCC Termination Failure alarm occurs when the ONS 15454 loses its DCC. Although this alarm is primarily SONET, it can apply to DWDM. For example, the OSCM card can raise this alarm on its OC-3 section overhead.

The SDCC consists of three bytes, D1 through D3, in the SONET overhead. The bytes convey information about operation, administration, maintenance, and provisioning (OAM&P). The ONS 15454 uses the DCC on the SONET section layer to communicate network management information.



Warning

On the ONS 15454 OC-192 card, the laser is on when the card is booted and the safety key is in the on position (labeled 1). The port does not have to be in service for the laser to be on. The laser is off when the safety key is off (labeled 0). Statement 293



Warning

Invisible laser radiation could be emitted from the end of the unterminated fiber cable or connector. Do not stare into the beam directly with optical instruments. Viewing the laser output with certain optical instruments (for example, eye loupes, magnifiers, and microscopes) within a distance of 100 mm could pose an eye hazard. Statement 1056



Warning

Use of controls, adjustments, or performing procedures other than those specified could result in hazardous radiation exposure. Statement 1057



Note

If a circuit shows a partial state when this alarm is raised, the logical circuit is in place. The circuit is able to carry traffic when the connection issue is resolved. You do not need to delete the circuit when troubleshooting this alarm.

Clear the EOC Alarm

- Step 1** If the “[LOS \(OCN\)](#)” alarm on [page 2-165](#) is also reported, complete the “[Clear the LOS \(OCN\) Alarm](#)” procedure on [page 2-166](#).



Caution

Always use the supplied electrostatic discharge wristband when working with a powered ONS 15454. Plug the wristband cable into the ESD jack located on the lower-right edge of the shelf assembly.

- Step 2** If the “[SF-L](#)” condition on [page 2-224](#) is reported, complete the “[Clear the SF-L Condition](#)” procedure on [page 2-224](#).

- Step 3** If the alarm does not clear on the reporting node, verify the physical connections between the cards and that the fiber-optic cables are configured to carry SDCC traffic. For more information about fiber connections and terminations, refer to the “[Install Cards and Fiber-Optic Cable](#)” chapter in the *Cisco ONS 15454 Procedure Guide*.

If the physical connections are correct and configured to carry DCC traffic, ensure that both ends of the fiber span have in-service (IS-NR) ports. Verify that the ACT/SBY LED on each card is green.

Step 4 When the LEDs on the cards are correctly illuminated, complete the [“Verify or Create Node Section DCC Terminations” procedure on page 2-276](#) to verify that the DCC is provisioned for the ports at both ends of the fiber span.

Step 5 Repeat [Step 4](#) at the adjacent nodes.

Step 6 If DCC is provisioned for the ends of the span, verify that the port is active and in service:

- a. Confirm that the card shows a green LED in CTC or on the physical card.
A green ACT/SBY LED indicates an active card. An amber ACT/SBY LED indicates a standby card.
- b. To determine whether the port is in service, double-click the card in CTC to open the card view.
- c. Click the **Provisioning > Line** tabs.
- d. Verify that the Admin State column lists the port as **IS**.
- e. If the Admin State column lists the port as OOS,MT or OOS,DSBLD, click the column and click **IS** in the drop-down list. Click **Apply**.



Note If a port in the IS admin state does not receive a signal, the LOS alarm is raised and the port service state transitions to OOS-AU,FLT.

Step 7 For all nodes, if the card is in service, use an optical test set to determine whether signal failures are present on fiber terminations. For specific procedures to use the test set equipment, consult the manufacturer.



Caution Using an optical test set can disrupt service on the OC-N card. It could be necessary to manually switch traffic carrying circuits over to a protection path. Refer to the [“2.9.2 Protection Switching, Lock Initiation, and Clearing” section on page 2-262](#) for commonly used switching procedures.

Step 8 If no signal failures exist on terminations, measure power levels to verify that the budget loss is within the parameters of the receiver. See the [“1.12.3 OC-N Card Transmit and Receive Levels” section on page 1-145](#) for non-DWDM card levels and refer to the *Cisco ONS 15454 DWDM Reference Manual* for DWDM card levels.

Step 9 If budget loss is within parameters, ensure that fiber connectors are securely fastened and properly terminated. For more information refer to the “Install Cards and Fiber-Optic Cable” chapter in the *Cisco ONS 15454 Procedure Guide*.

Step 10 If fiber connectors are properly fastened and terminated, complete the [“Reset an Active TCC2/TCC2P Card and Activate the Standby Card” procedure on page 2-271](#).

Wait ten minutes to verify that the card you reset completely reboots and becomes the standby card.

Resetting the active TCC2/TCC2P switches control to the standby TCC2/TCC2P. If the alarm clears when the ONS 15454 node switches to the standby TCC2/TCC2P, the user can assume that the previously active card is the cause of the alarm.

Step 11 If the TCC2/TCC2P reset does not clear the alarm, delete the problematic SDCC termination:

- a. From the **View menu in card view**, choose **Go to Previous View** if you have not already done so.
- b. Click the **Provisioning > Comm Channels > SDCC** tabs.
- c. Highlight the problematic DCC termination.

- d. Click **Delete**.
 - e. Click **Yes** in the Confirmation Dialog box.
- Step 12** Recreate the SDCC termination. Refer to the “Turn Up Network” chapter in the *Cisco ONS 15454 Procedure Guide* for procedures.
- Step 13** Verify that both ends of the DCC have been recreated at the optical ports.
- Step 14** If the alarm has not cleared, call Cisco TAC 1 800 553-2447. If the Cisco TAC technician tells you to reseal the card, complete the [“Remove and Reinsert \(Reseat\) the Standby TCC2/TCC2P Card” procedure on page 2-273](#). If the Cisco TAC technician tells you to remove the card and reinstall a new one, follow the [“Physically Replace a Traffic Card” procedure on page 2-274](#).

2.7.85 EOC-L

Default Severity: Minor (MN), Non-Service-Affecting (NSA) for OCN

SONET Logical Object: OCN

DWDM Logical Object: TRUNK

The Line DCC (LDCC) Termination Failure alarm occurs when the ONS 15454 loses its line data communications channel (LDCC) termination. In DWDM configurations, for example, the OSCM card can raise this alarm on its OC-3 line overhead.

The LDCC consists of nine bytes, D4 through D12, in the SONET overhead. The bytes convey information about OAM&P. The ONS 15454 uses the LDCCs on the SONET line layer to communicate network management information.



Warning

On the OC-192 card, the laser is on when the card is booted and the safety key is in the on position (labeled 1). The port does not have to be in service for the laser to be on. The laser is off when the safety key is off (labeled 0). Statement 293



Warning

Invisible laser radiation could be emitted from the end of the unterminated fiber cable or connector. Do not stare into the beam directly with optical instruments. Viewing the laser output with certain optical instruments (for example, eye loupes, magnifiers, and microscopes) within a distance of 100 mm could pose an eye hazard. Statement 1056



Warning

Use of controls, adjustments, or performing procedures other than those specified could result in hazardous radiation exposure. Statement 1057



Note

If a circuit shows a partial status when the [“EOC” alarm on page 2-83](#), or EOC-L is raised, it occurs when the logical circuit is in place. The circuit is able to carry traffic when the DCC termination issue is resolved. You do not need to delete the circuit when troubleshooting this alarm.

Clear the EOC-L Alarm

-
- Step 1** Complete the [“Clear the EOC Alarm” procedure on page 2-83](#).
- Step 2** If the alarm has not cleared, call Cisco TAC 1 800 553-2447. If the Cisco TAC technician tells you to reseat the card, complete the [“Remove and Reinsert \(Reseat\) the Standby TCC2/TCC2P Card” procedure on page 2-273](#). If the Cisco TAC technician tells you to remove the card and reinstall a new one, follow the [“Physically Replace a Traffic Card” procedure on page 2-274](#).
-

2.7.86 EQPT

Default Severity: Critical (CR), Service-Affecting (SA)

SONET Logical Objects: AICI-AEP, AICI-AIE, EQPT

DWDM Logical Object: PPM

An Equipment Failure alarm indicates that a hardware failure has occurred on the reporting card. If the EQPT alarm occurs with a BKUPMEMP alarm, refer to the [“BKUPMEMP” alarm on page 2-57](#). The BKUPMEMP procedure also clears the EQPT alarm.

This alarm is also invoked if a diagnostic circuit detects a card application-specific integrated circuit (ASIC) failure. In this case, if the card is part of a protection group, an APS switch occurs. If the card is the protect card, switching is inhibited and a [“PROTNA” alarm on page 2-199](#) is raised. The standby path generates a path-type alarm.

Clear the EQPT Alarm

-
- Step 1** If traffic is active on the alarmed port, you could need to switch traffic away from it. See the [“2.9.2 Protection Switching, Lock Initiation, and Clearing” section on page 2-262](#) for commonly used traffic-switching procedures.
- Step 2** Complete the [“Reset a Traffic Card in CTC” procedure on page 2-271](#) for the reporting card. For LED behavior, see the [“2.8.2 Typical Traffic Card LED Activity During Reset” section on page 2-260](#).
- Step 3** Verify that the reset is complete and error-free and that no new related alarms appear in CTC. Verify the LED status. A green ACT/SBY LED indicates an active card. An amber ACT/SBY LED indicates a standby card.
- Step 4** If the CTC reset does not clear the alarm, complete the [“Remove and Reinsert \(Reseat\) Any Card” procedure on page 2-274](#) for the reporting card.
- Step 5** If the physical reseat of the card fails to clear the alarm, complete the [“Physically Replace a Traffic Card” procedure on page 2-274](#) for the reporting card.
- Step 6** If the alarm does not clear, log into the Technical Support Website at <http://www.cisco.com/techsupport> for more information or call Cisco TAC 1 800 553-2447 in order to report a Service-Affecting (SA) problem.
-

2.7.87 EQPT-DIAG

Default Severity: Critical (CR), Service-Affecting (SA)

SONET Logical Object: EQPT

An Equipment-Diagnostic Failure alarm indicates that a software or hardware failure has occurred on the reporting card. This alarm can be raised against a traffic card or a cross-connect card.

Clear the EQPT-DIAG Alarm

-
- Step 1** If traffic is active on the alarmed card, you could need to switch traffic away from it. Refer to the [“2.9.2 Protection Switching, Lock Initiation, and Clearing”](#) section on page 2-262 for procedures.
 - Step 2** Complete the [“Remove and Reinsert \(Reseat\) Any Card”](#) procedure on page 2-274 for the alarmed card
 - Step 3** If the alarm does not clear, complete the [“Physically Replace a Traffic Card”](#) procedure on page 2-274 if it is raised against a traffic card, or complete the [“Physically Replace an In-Service Cross-Connect Card”](#) procedure on page 2-274 if the alarm is raised against the cross-connect card.
 - Step 4** If the alarm does not clear, log into the Technical Support Website at <http://www.cisco.com/techsupport> for more information or call Cisco TAC 1 800 553-2447.
-

2.7.88 EQPT-MISS

Default Severity: Critical (CR), Service-Affecting (SA)

SONET Logical Object: FAN

The Replaceable Equipment or Unit Missing alarm is reported against the fan-tray assembly unit. It indicates that the replaceable fan-tray assembly is missing or not fully inserted. It could also indicate that the ribbon cable connecting the AIP to the system board is bad.



Caution

Always use the supplied electrostatic discharge wristband when working with a powered ONS 15454. Plug the wristband cable into the ESD jack located on the lower-right edge of the shelf assembly.

Clear the EQPT-MISS Alarm

-
- Step 1** If the alarm is reported against the fan, verify that the fan-tray assembly is present.
 - Step 2** If the fan-tray assembly is present, complete the [“Replace the Fan-Tray Assembly”](#) procedure on page 2-281.
 - Step 3** If no fan-tray assembly is present, obtain a fan-tray assembly and refer to the [“Install the Fan-Tray Assembly,”](#) procedure in the *Cisco ONS 15454 Procedure Guide*.
 - Step 4** If the alarm does not clear, replace the ribbon cable from the AIP to the system board with a known-good ribbon cable.

- Step 5** If the alarm does not clear, log into the Technical Support Website at <http://www.cisco.com/techsupport> for more information or call Cisco TAC 1 800 553-2447 in order to report a Service-Affecting (SA) problem.
-

2.7.89 ERFI-P-CONN

Default Severity: Not Reported (NR), Non-Service-Affecting (NSA)

SONET Logical Objects: STSMON, STSTRM

The Three-Bit (Enhanced) Remote Failure Indication (ERFI) Path Connectivity condition is triggered on DS-1, DS-3, or VT circuits when the “UNEQ-P” alarm on page 2-253 and the “TIM-P” alarm on page 2-246 are raised on the transmission signal.

Clear the ERFI-P-CONN Condition

- Step 1** Complete the “Clear the UNEQ-P Alarm” procedure on page 2-253. This should clear the ERFI condition.
- Step 2** If the condition does not clear, log into the Technical Support Website at <http://www.cisco.com/techsupport> for more information or call Cisco TAC 1 800 553-2447.
-

2.7.90 ERFI-P-PAYLD

Default Severity: Not Reported (NR), Non-Service-Affecting (NSA)

SONET Logical Objects: STSMON, STSTRM

The Three-Bit ERFI Path Payload condition is triggered on DS-1, DS-3, or VT circuits when the “PLM-P” alarm on page 2-196 is raised on the transmission signal.

Clear the ERFI-P-PAYLD Condition

- Step 1** Complete the “Clear the PLM-P Alarm” procedure on page 2-197. This should clear the ERFI condition.
- Step 2** If the condition does not clear, log into the Technical Support Website at <http://www.cisco.com/techsupport> for more information or call Cisco TAC 1 800 553-2447.
-

2.7.91 ERFI-P-SRVR

Default Severity: Not Reported (NR), Non-Service-Affecting (NSA)

SONET Logical Objects: STSMON, STSTRM

The Three-Bit ERFI Path Server condition is triggered on DS-1, DS-3, or VT circuits when the “AIS-P” condition on page 2-38 or the “LOP-P” alarm on page 2-155 is raised on the transmission signal.

Clear the ERFI-P-SRVR Condition

-
- Step 1** Complete the “[Clear the LOP-P Alarm](#)” procedure on page 2-156. This should clear the ERFI condition.
- Step 2** If the condition does not clear, log into the Technical Support Website at <http://www.cisco.com/techsupport> for more information or call Cisco TAC 1 800 553-2447.
-

2.7.92 ERROR-CONFIG

Default Severity: Minor (MN), Non-Service-Affecting (NSA)

SONET Logical Object: EQPT

The Error in Startup Configuration alarm applies to the ML-Series Ethernet cards. These cards process startup configuration files line by line. If one or more lines cannot be executed, the error causes the ERROR-CONFIG alarm. ERROR-CONFIG is not caused by hardware failure.

The typical reasons for an errored startup file are:

- The user stored the configuration for one type of ML-Series card in the database and then installed another type in its slot.
- The configuration file contained a syntax error on one of the lines.
- The user stored the configuration for the ML-Series card and then changed the card mode from RPR-IEEE mode to another mode, or vice versa.



Note

For information about provisioning the ML-Series Ethernet cards from the Cisco IOS interface, refer to the *Cisco ONS 15454 and Cisco ONS 15454 SDH Ethernet Card Software Feature and Configuration Guide*.

Clear the ERROR-CONFIG Alarm

-
- Step 1** If you have a different type of ML-Series card specified in the startup configuration file than what you have installed, create the correct startup configuration.
- Follow the card provisioning instructions in the *Cisco ONS 15454 and Cisco ONS 15454 SDH Ethernet Card Software Feature and Configuration Guide*.
- Step 2** Upload the configuration file to the TCC2/TCC2P:
- a. In node view, right-click the ML-Series card graphic.
 - b. Choose **IOS Startup Config** from the shortcut menu.
 - c. Click **Local > TCC** and navigate to the file location in the Open dialog box.
- Step 3** Complete the “[Reset a Traffic Card in CTC](#)” procedure on page 2-271.
- Step 4** If the alarm does not clear or if your configuration file was correct according to the installed card, start a Cisco IOS CLI for the card:
- a. Right click the ML-Series card graphic in node view.
 - b. Choose **Open IOS Connection** from the shortcut menu.



Note Open IOS Connection is not available unless the ML-Series card is physically installed in the shelf.

Follow the card provisioning instructions in the *Cisco ONS 15454 and Cisco ONS 15454 SDH Ethernet Card Software Feature and Configuration Guide* to correct the errored configuration file line.

Step 5 Execute the CLI command:

```
router(config)#copy run start
```

The command copies the new card configuration into the database and clears the alarm.

Step 6 If the alarm does not clear, log into the Technical Support Website at <http://www.cisco.com/techsupport> for more information or call Cisco TAC 1 800 553-2447.

2.7.93 ETH-LINKLOSS

Default Severity: Not Alarmed (NA), Non-Service-Affecting (NSA)

SONET Logical Object: NE

The Rear Panel Ethernet Link Removed condition, if enabled in the network defaults, is raised under the following conditions:

- The `node.network.general.AlarmMissingBackplaneLAN` field in NE default is enabled.
- The node is configured as a gateway network element (GNE).
- The backplane LAN cable is removed.



Note For more information about Ethernet cards, refer to the *Cisco ONS 15454 and Cisco ONS 15454 SDH Ethernet Card Software Feature and Configuration Guide*.

Clear the ETH-LINKLOSS Condition

Step 1 To clear this condition, reconnect the backplane LAN cable. Refer to the “Install the Shelf and Backplane Cable” chapter in the *Cisco ONS 15454 Procedure Guide* for procedures to install this cable.

Step 2 If the condition does not clear, log into the Technical Support Website at <http://www.cisco.com/techsupport> for more information or call Cisco TAC 1 800 553-2447.

2.7.94 E-W-MISMATCH

Default Severity: Major (MJ), Service-Affecting (SA)

SONET Logical Object: OCN

A Procedural Error Misconnect East/West Direction alarm occurs during BLSR setup, or when nodes in a ring have slots misconnected. An east slot can be misconnected to another east slot, or a west slot can be misconnected to another west slot. In most cases, the user did not connect the fibers correctly or the

ring provisioning plan was flawed. You can physically reconnect the cable to the correct slots to clear the E-W-MISMATCH alarm. Alternately, you can delete and recreate the span in CTC to change the west line and east line designations. The CTC method clears the alarm, but could change the traditional east-west node connection pattern of the ring.

**Note**

The E-W-MISMATCH alarm also appears during the initial set up of a ring with its east-west slots configured correctly. If the alarm appears during the initial setup, the alarm clears itself shortly after the ring setup is complete.

**Note**

The lower-numbered slot at a node is traditionally labeled the west slot and the higher numbered slot is labeled the east slot. For example, Slot 6 is west and Slot 12 is east.

**Note**

The physical switch procedure is the recommend method of clearing the E-W-MISMATCH alarm. The physical switch method reestablishes the logical pattern of connection in the ring. However, you can also use CTC to recreate the span and identify the misconnected slots as east and west. The CTC method is useful when the misconnected node is not geographically near the troubleshooter.

Clear the E-W-MISMATCH Alarm with a Physical Switch

- Step 1** Diagram the ring setup, including nodes and spans, on a piece of paper or white board.
- Step 2** In node view, click **View > Go to Network View**.
- Step 3** Click the circuit and click **Edit**. The network map detailed view window appears. This window contains the node name, slot, and port for each end of each span.
- Step 4** Label each of the nodes on the diagram with the same name that appears on the network map.
- Step 5** Label the span ends on the diagram with the same information. For example, with Node 1/Slot 12/Port 1—Node 2/Slot 6/Port 1 (2F BLSR OC48, ring name=0), label the end of the span that connects Node 1 and Node 2 at the Node 1 end as Slot 12/Port 1. Label the Node 2 end of that same span Slot 6/Port 1.
- Step 6** Repeat Steps 4 and 5 for each span on your diagram.
- Step 7** Label the highest slot at each node east and the lowest slot at each node west.
- Step 8** Examine the diagram. You should see a clockwise pattern of west slots connecting to east slots for each span. Refer to the “Install Cards and Fiber-Optic Cable” chapter in the *Cisco ONS 15454 Procedure Guide* for more information about cabling the system.
- Step 9** If any span has an east-to-east or west-to-west connection, physically switching the fiber connectors from the card that does not fit the pattern to the card that continues the pattern should clear the alarm.

**Warning**

On the OC-192 card, the laser is on when the card is booted and the safety key is in the on position (labeled 1). The port does not have to be in service for the laser to be on. The laser is off when the safety key is off (labeled 0). Statement 293

**Warning**

Invisible laser radiation could be emitted from the end of the unterminated fiber cable or connector. Do not stare into the beam directly with optical instruments. Viewing the laser output with certain optical instruments (for example, eye loupes, magnifiers, and microscopes) within a distance of 100 mm could pose an eye hazard. Statement 1056

**Warning**

Use of controls, adjustments, or performing procedures other than those specified could result in hazardous radiation exposure. Statement 1057

- Step 10** If the alarm does not clear, log into the Technical Support Website at <http://www.cisco.com/techsupport> for more information or call Cisco TAC 1 800 553-2447 in order to report a Service-Affecting (SA) problem.

Clear the E-W-MISMATCH Alarm in CTC

- Step 1** Log into the misconnected node. A misconnected node has both ring fibers connecting it to its neighbor nodes misconnected.
- Step 2** Click the **Maintenance > BLSR** tabs.
- Step 3** From the row of information for the fiber span, complete the “[Identify a BLSR Ring Name or Node ID Number](#)” procedure on page 2-261 to identify the node ID, ring name, and the slot and port in the East Line column and West Line column. Record the above information.
- Step 4** Click **View > Go to Network View**.
- Step 5** Delete and recreate the BLSR:
- a. Click the **Provisioning > BLSR** tabs.
 - b. Click the row from [Step 3](#) to select it and click **Delete**.
 - c. Click **Create**.
 - d. Fill in the ring name and node ID from the information collected in [Step 3](#).
 - e. Click **Finish**.
- Step 6** Display node view and click the **Maintenance > BLSR** tabs.
- Step 7** Change the West Line field to the slot you recorded for the East Line in [Step 3](#).
- Step 8** Change the East Line field to the slot you recorded for the West Line in [Step 3](#).
- Step 9** Click **OK**.
- Step 10** If the alarm does not clear, log into the Technical Support Website at <http://www.cisco.com/techsupport> for more information or call Cisco TAC 1 800 553-2447 in order to report a Service-Affecting (SA) problem.

2.7.95 EXCCOL

Default Severity: Minor (MN), Non-Service-Affecting (NSA)

SONET Logical Object: EQPT

The Excess Collisions on the LAN alarm indicates that too many collisions are occurring between data packets on the network management LAN, and communications between the ONS 15454 and CTC could be affected. The network management LAN is the data network connecting the workstation running the CTC software to the TCC2/TCC2P. The problem causing the alarm is external to the ONS 15454.

Troubleshoot the network management LAN connected to the TCC2/TCC2P for excess collisions. You might need to contact the system administrator of the network management LAN to accomplish the following steps.

Clear the EXCCOL Alarm

-
- Step 1** Verify that the network device port connected to the TCC2/TCC2P has a flow rate set to 10 Mb, half-duplex.
 - Step 2** If the port has the correct flow rate and duplex setting, troubleshoot the network device connected to the TCC2/TCC2P and the network management LAN.
 - Step 3** If the alarm does not clear, log into the Technical Support Website at <http://www.cisco.com/techsupport> for more information or call Cisco TAC 1 800 553-2447.
-

2.7.96 EXERCISE-RING-FAIL

Default Severity: Not Alarmed (NA), Non-Service-Affecting (NSA)

SONET Logical Object: OCN

The Exercise Ring command issues ring protection switching of the requested channel without completing the actual bridge and switch. The EXERCISE-RING-FAIL condition is raised if the command was issued and accepted but the exercise did not take place.



Note

If the exercise command gets rejected due to the existence of a higher-priority condition in the ring, EXERCISE-RING-FAIL is Not Reported (NR).

Clear the EXERCISE-RING-FAIL Condition

-
- Step 1** Look for and clear, if present, the “[LOF \(OCN\)](#)” alarm on page 2-152, the “[LOS \(OCN\)](#)” alarm on page 2-165, or a BLSR alarm.
 - Step 2** Complete the “[Initiate an Exercise Ring Switch on a BLSR](#)” procedure on page 2-269.
 - Step 3** If the condition does not clear, log into the Technical Support Website at <http://www.cisco.com/techsupport> for more information or call Cisco TAC 1 800 553-2447.
-

2.7.97 EXERCISE-SPAN-FAIL

Default Severity: Not Alarmed (NA), Non-Service-Affecting (NSA)

SONET Logical Object: OCN

The Exercise Span command issues span switching of the requested channel without completing the actual bridge and switch. The EXERCISE-SPAN-FAIL condition is raised if the command was issued and accepted but the exercise did not take place.



Note

If the exercise command gets rejected due to the existence of a higher-priority condition in the span or ring, EXERCISE-SPAN-FAIL is Not Reported (NR).

Clear the EXERCISE-SPAN-FAIL Condition

-
- Step 1** Look for and clear, if present, the “LOF (OCN)” alarm on page 2-152, the “LOS (OCN)” alarm on page 2-165, or a BLSR alarm.
 - Step 2** Complete the “Initiate an Exercise Ring Switch on a BLSR” procedure on page 2-269.
 - Step 3** If the condition does not clear, log into the Technical Support Website at <http://www.cisco.com/techsupport> for more information or call Cisco TAC 1 800 553-2447.
-

2.7.98 EXT

Default Severity: Minor (MN), Non-Service-Affecting (NSA)

SONET Logical Object: ENVALRM

A Failure Detected External to the NE alarm occurs because an environmental alarm is present. For example, a door could be open or flooding could have occurred.

Clear the EXT Alarm

-
- Step 1** In node view double-click the AIC-I card to open the card view.
 - Step 2** Double-click the **Maintenance > External Alarms** tab.
 - Step 3** Follow your standard operating procedure to remedy environmental conditions that cause alarms. The alarm clears when the situation is remedied.
 - Step 4** If the alarm does not clear, log into the Technical Support Website at <http://www.cisco.com/techsupport> for more information or call Cisco TAC 1 800 553-2447.
-

2.7.99 EXTRA-TRAF-PREEMPT

Default Severity: Major (MJ), Service-Affecting (SA)

SONET Logical Object: OCN

An Extra Traffic Preempted alarm occurs on OC-N cards in two-fiber and four-fiber BLSRs when low-priority traffic directed to the protect system has been preempted by a working system protection switch.

Clear the EXTRA-TRAF-PREEMPT Alarm

-
- Step 1** Verify that the protection switch has occurred by checking the Conditions tab.
- Step 2** If a ring switch has occurred, clear the ring switch on the working system by following the appropriate alarm in this chapter. For more information about protection switches, refer to the “[2.9.2 Protection Switching, Lock Initiation, and Clearing](#)” section on page 2-262 or the “Maintain the Node” chapter in the *Cisco ONS 15454 Procedure Guide*.
- Step 3** If the alarm occurred on a four-fiber BLSR and the span switch occurred on this OC-N, clear the span switch on the working system.
- Step 4** If the alarm does not clear, log into the Technical Support Website at <http://www.cisco.com/techsupport> for more information or call Cisco TAC 1 800 553-2447 in order to report a Service-Affecting (SA) problem.
-

2.7.100 FAILTOSW

Default Severity: Not Alarmed (NA), Non-Service-Affecting (NSA)

SONET Logical Objects: EQPT, OCN

DWDM Logical Objects: 2R, ESCON, FC, GE, ISC, TRUNK

The Failure to Switch to Protection Facility condition occurs when a working or protect electrical or optical facility switches to its companion port by using a MANUAL command. For example, if you attempt to manually switch traffic from an unused protect port to an in-service working port, the switch will fail (because traffic is already present on the working port) and you will see the FAILTOSW condition.

Clear the FAILTOSW Condition

-
- Step 1** Look up and troubleshoot the higher-priority alarm. Clearing the higher-priority condition frees the card and clears the FAILTOSW.



Note A higher-priority alarm is an alarm raised on the working DS-N card using the 1:N card protection group. The working DS-N card is reporting an alarm but not reporting a FAILTOSW condition.

- Step 2** If the condition does not clear, replace the working electrical or optical card that is reporting the higher-priority alarm by following the “[Physically Replace a Traffic Card](#)” procedure on page 2-274. This card is the working electrical or optical card using the protect card and not reporting FAILTOSW. Replacing the working electrical or optical card that is reporting the higher-priority alarm allows traffic to revert to the working slot and the card reporting the FAILTOSW to switch to the protect card.
- Step 3** If the condition does not clear, log into the Technical Support Website at <http://www.cisco.com/techsupport> for more information or call Cisco TAC 1 800 553-2447.
-

2.7.101 FAILTOSW-PATH

Default Severity: Not Alarmed (NA), Non-Service-Affecting (NSA)

SONET Logical Objects: STSMON, VT-MON

The Fail to Switch to Protection Path condition occurs when the working circuit does not switch to the protection circuit on a UPSR. Common causes of the FAILTOSW-PATH alarm include a missing or defective protect port, a lockout set on one of the UPSR nodes, or path-level alarms that would cause a UPSR switch to fail including the “AIS-P” condition on page 2-38, the “LOP-P” alarm on page 2-155, the “SD-P” condition on page 2-221, the “SF-P” condition on page 2-225, and the “UNEQ-P” alarm on page 2-253.

The “LOF (OCN)” alarm on page 2-152, the “LOS (OCN)” alarm on page 2-165, the “SD-L” condition on page 2-221, or the “SF-L” condition on page 2-224 can also occur on the failed path.

Clear the FAILTOSW-PATH Condition in a UPSR Configuration

- Step 1** Look up and clear the higher-priority alarm. Clearing this alarm frees the standby card and clears the FAILTOSW-PATH condition. If the “AIS-P” condition on page 2-38, the “LOP-P” alarm on page 2-155, the “UNEQ-P” alarm on page 2-253, the “SF-P” condition on page 2-225, the “SD-P” condition on page 2-221, the “LOF (OCN)” alarm on page 2-152, the “LOS (OCN)” alarm on page 2-165, the “SD-L” condition on page 2-221, or the “SF-L” condition on page 2-224 are also occurring on the reporting port, complete the applicable alarm clearing procedure.



Note A higher-priority alarm is an alarm raised on the working electrical card using the 1:N card protection group. The working DS-N card is reporting an alarm but not reporting a FAILTOSW condition.

- Step 2** If the condition does not clear, replace the active OC-N card that is reporting the higher-priority alarm. Complete the “Physically Replace a Traffic Card” procedure on page 2-274. Replacing the active OC-N card that is reporting the higher-priority alarm allows traffic to revert to the active slot. Reverting frees the standby card, which can then take over traffic from the card reporting the lower-priority alarm and the FAILTOSW-PATH condition.
- Step 3** If the condition does not clear, log into the Technical Support Website at <http://www.cisco.com/techsupport> for more information or call Cisco TAC 1 800 553-2447.

2.7.102 FAILTOSWR

Default Severity: Not Alarmed (NA), Non-Service-Affecting (NSA)

SONET Logical Object: OCN

The Fail to Switch to Protection Ring condition occurs when a ring switch did not complete because of internal APS problems.

FAILTOSWR clears in any of the following situations:

- A physical card pull of the active TCC2/TCC2P (done under Cisco TAC supervision).
- A node power cycle.

- A higher-priority event such as an external switch command.
- The next ring switch succeeds.
- The cause of the APS switch (such as the “SD-L” condition on page 2-221 or the “SF-L” condition on page 2-224) clears.



Warning

On the OC-192 card, the laser is on when the card is booted and the safety key is in the on position (labeled 1). The port does not have to be in service for the laser to be on. The laser is off when the safety key is off (labeled 0). Statement 293



Warning

Invisible laser radiation could be emitted from the end of the unterminated fiber cable or connector. Do not stare into the beam directly with optical instruments. Viewing the laser output with certain optical instruments (for example, eye loupes, magnifiers, and microscopes) within a distance of 100 mm could pose an eye hazard. Statement 1056



Warning

Use of controls, adjustments, or performing procedures other than those specified could result in hazardous radiation exposure. Statement 1057

Clear the FAILTOSWR Condition in a BLSR Configuration

- Step 1** Perform the Exercise Ring command on the reporting card:
- Click the **Maintenance > BLSR** tabs.
 - Click the row of the affected ring under the West Switch column.
 - Select **Exercise Ring** in the drop-down list.
- Step 2** If the condition does not clear, from the view menu, choose **Go to Network View**.
- Step 3** Look for alarms on OC-N cards that make up the ring or span and troubleshoot these alarms.
- Step 4** If clearing other alarms does not clear the FAILTOSWR condition, log into the near-end node.
- Step 5** Click the **Maintenance > BLSR** tabs.
- Step 6** Record the OC-N cards listed under West Line and East Line. Ensure that these OC-N cards and ports are active and in service:
- Verify the LED status: A green ACT/SBY LED indicates an active card. An amber ACT/SBY LED indicates a standby card.
 - Double-click the card in CTC to open the card view.
 - Click the **Provisioning > Line** tabs.
 - Verify that the Admin State column lists the port as IS.
 - If the Admin State column lists the port as OOS,MT or OOS,DSBLD, click the column and choose **IS**. Click **Apply**.

**Note**

If a port in the IS admin state does not receive a signal, the LOS alarm is raised and the port service state transitions to OOS-AU,FLT.

- Step 7** If the OC-N cards are active and in service, verify fiber continuity to the ports on the recorded cards. To verify fiber continuity, follow site practices.
- Step 8** If fiber continuity to the ports is good, use an optical test set to verify that a valid signal exists on the line. For specific procedures to use the test set equipment, consult the manufacturer. Test the line as close to the receiving card as possible.

**Caution**

Using an optical test set disrupts service on the OC-N card. It could be necessary to manually switch traffic carrying circuits over to a protection path. Refer to the [“2.9.2 Protection Switching, Lock Initiation, and Clearing”](#) section on page 2-262 for commonly used switching procedures.

- Step 9** If the signal is valid, clean the fiber according to site practice. If no site practice exists, complete the procedure in the “Maintain the Node” chapter in the *Cisco ONS 15454 Procedure Guide*.
- Step 10** If cleaning the fiber does not clear the condition, verify that the power level of the optical signal is within the OC-N card receiver specifications. The [“1.12.3 OC-N Card Transmit and Receive Levels”](#) section on page 1-145 lists these specifications.
- Step 11** Repeat Steps 7 through 10 for any other ports on the card.
- Step 12** If the optical power level for all OC-N cards is within specifications, complete the [“Physically Replace a Traffic Card”](#) procedure on page 2-274 for the protect standby OC-N card.
- Step 13** If the condition does not clear after you replace the BLSR cards on the node one by one, repeat Steps 4 through 12 for each of the nodes in the ring.
- Step 14** If the condition does not clear, log into the Technical Support Website at <http://www.cisco.com/techsupport> for more information or call Cisco TAC 1 800 553-2447.

2.7.103 FAILTOSWS

Default Severity: Not Alarmed (NA), Non-Service-Affecting (NSA)

SONET Logical Object: OCN

The Failure to Switch to Protection Span condition signals an APS span switch failure. For a four-fiber BLSR, a failed span switch initiates a ring switch. If the ring switch occurs, the FAILTOSWS condition does not appear. If the ring switch does not occur, the FAILTOSWS condition appears. FAILTOSWS clears when one of the following situations occurs:

- A physical card pull of the active TCC2/TCC2P done under Cisco TAC supervision.
- A node power cycle.
- A higher-priority event such as an external switch command occurs.
- The next span switch succeeds.
- The cause of the APS switch (such as the [“SD-L”](#) condition on page 2-221 or the [“SF-L”](#) condition on page 2-224) clears.

Clear the FAILTOSWS Condition

- Step 1** Perform the Exercise Span command on the reporting card:
- a. Click the **Maintenance > BLSR** tabs.

- b. Determine whether the card you would like to exercise is the west card or the east card.
- c. Click the row of the affected span under the East Switch or West Switch column.
- d. Select **Exercise Span** in the drop-down list.

- Step 2** If the condition does not clear, from the view menu, choose **Go to Network View**.
- Step 3** Look for alarms on OC-N cards that make up the ring or span and troubleshoot these alarms.
- Step 4** If clearing other alarms does not clear the FAILTOSWS condition, log into the near-end node.
- Step 5** Click the **Maintenance > BLSR** tabs.
- Step 6** Record the OC-N cards listed under West Line and East Line. Ensure that these OC-N cards are active and in service:
- a. Verify the LED status: A green ACT/SBY LED indicates an active card. An amber ACT/SBY LED indicates a standby card.
 - b. To determine whether the OC-N port is in service, double-click the card in CTC to open the card view.
 - c. Click the **Provisioning > Line** tabs.
 - d. Verify that the Admin State column lists the port as IS.
 - e. If the Admin State column lists the port as OOS,MT or OOS,DSBLD, click the column and choose **IS**. Click **Apply**.



Note If a port in the IS admin state does not receive a signal, the LOS alarm is raised and the port service state transitions to OOS-AU,FLT.

- Step 7** If the OC-N cards are active and in service, verify fiber continuity to the ports on the recorded cards. To verify fiber continuity, follow site practices.
- Step 8** If fiber continuity to the ports is good, use an optical test set to verify that a valid signal exists on the line. For specific procedures to use the test set equipment, consult the manufacturer. Test the line as close to the receiving card as possible.



Caution Using an optical test set disrupts service on the OC-N card. It could be necessary to manually switch traffic carrying circuits over to a protection path. Refer to the [“2.9.2 Protection Switching, Lock Initiation, and Clearing”](#) section on page 2-262 for commonly used switching procedures.

- Step 9** If the signal is valid, clean the fiber according to site practice. If no site practice exists, complete the procedure in the “Maintain the Node” chapter in the *Cisco ONS 15454 Procedure Guide*.
- Step 10** If cleaning the fiber does not clear the condition, verify that the power level of the optical signal is within the OC-N card receiver specifications. The [“1.12.3 OC-N Card Transmit and Receive Levels”](#) section on page 1-145 lists these specifications.
- Step 11** Repeat Steps 7 through 10 for any other ports on the card.
- Step 12** If the optical power level for all OC-N cards is within specifications, complete the [“Physically Replace a Traffic Card”](#) procedure on page 2-274 for the protect standby OC-N card.
- Step 13** If the condition does not clear after you replace the BLSR cards on the node one by one, follow Steps 4 through 12 for each of the nodes in the ring.

- Step 14** If the condition does not clear, log into the Technical Support Website at <http://www.cisco.com/techsupport> for more information or call Cisco TAC 1 800 553-2447.
-

2.7.104 FAN

Default Severity: Critical (CR), Service-Affecting (SA)

SONET Logical Object: FAN

The Fan Failure alarm indicates a problem with the fan-tray assembly. When the fan-tray assembly is not fully functional, the temperature of the ONS 15454 can rise above its normal operating range.

The fan-tray assembly contains six fans and needs a minimum of five working fans to properly cool the shelf. However, even with five working fans, the fan-tray assembly could need replacement because a sixth working fan is required for extra protection against overheating.



Caution

Always use the supplied electrostatic discharge wristband when working with a powered ONS 15454. Plug the wristband cable into the ESD jack located on the lower-right edge of the shelf assembly.

Clear the FAN Alarm

-
- Step 1** Determine whether the air filter needs replacement. Complete the “[Inspect, Clean, and Replace the Reusable Air Filter](#)” procedure on page 2-279.
- Step 2** If the filter is clean, complete the “[Remove and Reinsert a Fan-Tray Assembly](#)” procedure on page 2-280.
- Step 3** If the fan does not run or the alarm persists, complete the “[Replace the Fan-Tray Assembly](#)” procedure on page 2-281. The fan should run immediately when correctly inserted.
- Step 4** If the replacement fan-tray assembly does not operate correctly, log into the Technical Support Website at <http://www.cisco.com/techsupport> for more information or call Cisco TAC to report a Service-Affecting (SA) problem 1 800 553-2447.
-

2.7.105 FAPS

Default Severity: Not Alarmed (NA), Non-Service-Affecting (NSA)

SONET Logical Object: FCMR

DWDM Logical Objects: TRUNK

The Fast Automatic Protection Switching condition is applicable to GEXP/10GEXP cards. This condition occurs when the protection port, on the master card, switches from blocking to forwarding state.

Clear the FAPS Alarm

-
- Step 1** When the cause of switching disappears, the protection port switches from the forwarding to the blocking state, and the FAPS alarm clears.
- Step 2** If the alarm does not clear even after the protection port switches back to the blocking state, log into the Technical Support Website at <http://www.cisco.com/techsupport> for more information or call Cisco TAC (1 800 553-2447).
-

2.7.106 FAPS-CONFIG-MISMATCH

For information about this alarm or condition, refer to the “Alarm Troubleshooting” chapter in the *Cisco ONS 15454 DWDM Troubleshooting Guide*. This guide discusses all DWDM alarms.

2.7.107 FC-DE-NES

Default Severity: Major (MJ), Service-Affecting (SA)

SONET Logical Object: FCMR

DWDM Logical Objects: FC, TRUNK

The Fiber Channel Distance Extension Function Not Established condition occurs when the Fiber Channel client setup or distance extension configuration is incorrect.

Clear the FC-DE-NES Alarm

-
- Step 1** Ensure that the FC client setup and distance extension configuration is correct.
- Step 2** If the condition does not clear, log into the Technical Support Website at <http://www.cisco.com/techsupport> for more information or call Cisco TAC (1 800 553-2447).
-

2.7.108 FC-NO-CREDITS

Default Severity: Major (MJ), Service-Affecting (SA)

SONET Logical Object: FCMR

DWDM Logical Objects: FC, TRUNK

The Fibre Channel Distance Extension Credit Starvation alarm occurs on storage access networking (SAN) Fibre Channel/Fiber Connectivity (FICON) FC_MR-4 cards when the congestion prevents the generic framing procedure (GFP) transmitter from sending frames to the FC_MR-4 card port. For example, the alarm can be raised when an operator configures a card to autodetect framing credits but the card is not connected to an interoperable FC-SW-standards-based Fibre Channel/FICON port.

FC-NO-CREDITS is raised only if transmission is completely prevented. (If traffic is slowed but still passing, this alarm is not raised.) The alarm is raised in conjunction with the GFP-NO-BUFFERS alarm. For example, if the FC-NO-CREDITS alarm is generated at an FC_MR-4 data port, a GFP-NO-BUFFERS alarm could be raised at the upstream remote FC_MR-4 data port.

Clear the FC-NO-CREDITS Alarm

Step 1 If the port is connected to a Fibre Channel/FICON switch, make sure it is configured for interoperation mode using the manufacturer's instructions.

Step 2 If the port is not connected to a switch, turn off Autodetect Credits:

- a. Double-click the FC_MR-4 card.
- b. Click **Provisioning > Port > General**.
- c. Under Admin State, click the cell and choose **OOS,MT**.
- d. Click **Apply**.
- e. Click the **Provisioning > Port > Distance Extension** tabs.
- f. Uncheck the **Autodetect Credits** column check box.
- g. Click **Apply**.
- h. Click **Provisioning > Port > General**.
- i. Under Admin State, click the cell and choose **IS**.
- j. Click **Apply**.



Note If a port in the IS admin state does not receive a signal, the LOS alarm is raised and the port service state transitions to OOS-AU,FLT.

Step 3 Program the Credits Available value based on the buffers available on the connected equipment:



Note The NumCredits must be provisioned to a value smaller than or equal to the receive buffers or credits available on the connected equipment.

- a. Double-click the FC_MR-4 card.
- b. Click the **Provisioning > Port > Distance Extension** tabs.
- c. Enter a new value in the Credits Available column.
- d. Click **Apply**.

Step 4 If the condition does not clear, log into the Technical Support Website at <http://www.cisco.com/techsupport> for more information or call Cisco TAC 1 800 553-2447 to report a Service-Affecting (SA) problem.

2.7.109 FDI

For information about this alarm or condition, refer to the “Alarm Troubleshooting” chapter in the *Cisco ONS 15454 DWDM Troubleshooting Guide*. This guide discusses all DWDM alarms.

2.7.110 FE-AIS

Default Severity: Not Alarmed (NA), Non-Service-Affecting (NSA)

SONET Logical Object: DS3

The Far-End AIS condition occurs when an AIS has occurred at the far-end node. FE-AIS usually occurs in conjunction with a downstream LOS alarm (see the “[LOS \(OCN\)](#)” alarm on page 2-165).

Generally, any AIS is a special SONET signal that communicates to the receiving node when the transmit node does not send a valid signal. AIS is not considered an error. It is raised by the receiving node on each input when it detects the AIS instead of a real signal. In most cases when this condition is raised, an upstream node is raising an alarm to indicate a signal failure; all nodes downstream from it only raise some type of AIS. This condition clears when you resolved the problem on the upstream node.

Clear the FE-AIS Condition

-
- Step 1** Complete the “[Clear the AIS Condition](#)” procedure on page 2-37.
- Step 2** If the condition does not clear, log into the Technical Support Website at <http://www.cisco.com/techsupport> for more information or call Cisco TAC 1 800 553-2447.
-

2.7.111 FEC-MISM

For information about this alarm or condition, refer to the “Alarm Troubleshooting” chapter in the *Cisco ONS 15454 DWDM Troubleshooting Guide*. This guide discusses all DWDM alarms.

2.7.112 FE-DS1-MULTLOS

Default Severity: Not Alarmed (NA), Non-Service-Affecting (NSA)

SONET Logical Object: DS3

The Far-End Multiple DS-1 LOS Detected condition occurs when multiple DS-1 signals are lost on a far-end DS-1 card.

The prefix FE means the main alarm is occurring at the far-end node and not at the node reporting the FE-DS1-MULTLOS condition. Troubleshoot the FE alarm or condition by troubleshooting the main alarm at its source. The secondary alarms or conditions clear when the main alarm clears.

Clear the FE-DS1-MULTLOS Condition

-
- Step 1** To troubleshoot an FE condition, determine which node and card link directly to the card reporting the FE condition. For example, an ONS 15454 FE condition on a card in Slot 12 of Node 1 could relate to a main alarm from a card in Slot 6 of Node 2.
 - Step 2** Log into the node that links directly to the card reporting the FE condition.
 - Step 3** Clear the main alarm. Refer to the appropriate alarm section in this chapter for troubleshooting instructions.
 - Step 4** If the condition does not clear, log into the Technical Support Website at <http://www.cisco.com/techsupport> for more information or call Cisco TAC 1 800 553-2447.
-

2.7.113 FE-DS1-NSA

Default Severity: Not Alarmed (NA), Non-Service-Affecting (NSA)

SONET Logical Object: DS3

The Far End DS-1 Equipment Failure Non-Service-Affecting (NSA) condition occurs when a far-end DS-1 equipment failure occurs, but does not affect service because the port is protected and traffic is able to switch to the protect port.

Clear the FE-DS1-NSA Condition

-
- Step 1** To troubleshoot an FE condition, determine which node and card link directly to the card reporting the FE alarm. For example, an alarm from a card in an ONS 15454 Slot 12 of Node 1 could link to an alarm from a card in Slot 6 of Node 2.
 - Step 2** Log into the node that links directly to the card reporting the FE condition.
 - Step 3** Clear the main alarm. Refer to the appropriate alarm section in this chapter for troubleshooting instructions.
 - Step 4** If the condition does not clear, log into the Technical Support Website at <http://www.cisco.com/techsupport> for more information or call Cisco TAC 1 800 553-2447.
-

2.7.114 FE-DS1-SA

Default Severity: Not Alarmed (NA), Non-Service-Affecting (NSA)

SONET Logical Object: DS3

The Far End DS-1 Equipment Failure Service Affecting condition occurs when there is a far-end equipment failure on a DS-1 card that affects service because traffic is unable to switch to the protect port.

Clear the FE-DS1-SA Condition

-
- Step 1** To troubleshoot an FE condition, determine which node and card link directly to the card reporting the FE alarm. For example, an alarm from a card in Slot 12 of Node 1 could link to an alarm from a card in Slot 6 of Node 2.
 - Step 2** Log into the node that links directly to the card reporting the FE condition.
 - Step 3** Clear the main alarm. Refer to the appropriate alarm section in this chapter for troubleshooting instructions.
 - Step 4** If the condition does not clear, log into the Technical Support Website at <http://www.cisco.com/techsupport> for more information or call Cisco TAC 1 800 553-2447.
-

2.7.115 FE-DS1-SNGLLOS

Default Severity: Not Alarmed (NA), Non-Service-Affecting (NSA)

SONET Logical Object: DS3

The Far-End Single DS-1 LOS condition occurs when a single DS-1 signal is lost on far-end DS-1 equipment (within a DS3). Signal loss also causes the “[LOS \(OCN\)](#)” alarm on page 2-165.

Clear the FE-DS1-SNGLLOS Condition

-
- Step 1** To troubleshoot an FE condition, determine which node and card link directly to the card reporting the FE condition. For example, an FE condition on a card in Slot 12 of Node 1 could link to an alarm from a card in Slot 6 of Node 2.
 - Step 2** Log into the node that links directly to the card reporting the FE condition.
 - Step 3** Clear the main alarm. Refer to the appropriate alarm section in this chapter for troubleshooting instructions.
 - Step 4** If the condition does not clear, log into the Technical Support Website at <http://www.cisco.com/techsupport> for more information or call Cisco TAC 1 800 553-2447.
-

2.7.116 FE-DS3-NSA

Default Severity: Not Alarmed (NA), Non-Service-Affecting (NSA)

SONET Logical Object: DS3

The Far End DS-3 Equipment Failure Non-Service-Affecting (NSA) condition occurs when a far-end ONS 15454 DS-3 equipment failure occurs in C-bit framing mode, but does not affect service because the port is protected and traffic is able to switch to the protect port.

Clear the FE-DS3-NSA Condition

-
- Step 1** To troubleshoot an FE condition, determine which node and card link directly to the card reporting the FE alarm. For example, an alarm from a card in Slot 12 of Node 1 could link to an alarm from a card in Slot 6 of Node 2.
 - Step 2** Log into the node that links directly to the card reporting the FE condition.
 - Step 3** Clear the main alarm. Refer to the appropriate alarm section in this chapter for troubleshooting instructions.
 - Step 4** If the condition does not clear, log into the Technical Support Website at <http://www.cisco.com/techsupport> for more information or call Cisco TAC 1 800 553-2447.
-

2.7.117 FE-DS3-SA

Default Severity: Not Alarmed (NA), Non-Service-Affecting (NSA)

SONET Logical Object: DS3

The Far End DS-3 Equipment Failure Service Affecting condition occurs when there is a far-end equipment failure on an ONS 15454 DS-3 card in C-bit framing mode that affects service because traffic is unable to switch to the protect port.

Clear the FE-DS3-SA Condition

-
- Step 1** To troubleshoot an FE condition, determine which node and card link directly to the card reporting the FE alarm. For example, an alarm from a card in Slot 12 of Node 1 could link to an alarm from a card in Slot 6 of Node 2.
 - Step 2** Log into the node that links directly to the card reporting the FE condition.
 - Step 3** Clear the main alarm. Refer to the appropriate alarm section in this chapter for troubleshooting instructions.
 - Step 4** If the condition does not clear, log into the Technical Support Website at <http://www.cisco.com/techsupport> for more information or call Cisco TAC 1 800 553-2447.
-

2.7.118 FE-EQPT-NSA

Default Severity: Not Alarmed (NA), Non-Service-Affecting (NSA)

SONET Logical Object: DS3

The Far End Common Equipment Failure condition occurs when a Non-Service-Affecting (NSA) equipment failure is detected on far-end DS-3 equipment.

Clear the FE-EQPT-NSA Condition

-
- Step 1** To troubleshoot an FE condition, determine which node and card link directly to the card reporting the FE condition. For example, an FE condition on a card in Slot 12 of Node 1 could relate to a main alarm from a card in Slot 6 of Node 2.
 - Step 2** Log into the node that links directly to the card reporting the FE condition.
 - Step 3** Clear the main alarm. Refer to the appropriate alarm section in this chapter for troubleshooting instructions.
 - Step 4** If the condition does not clear, log into the Technical Support Website at <http://www.cisco.com/techsupport> for more information or call Cisco TAC 1 800 553-2447.
-

2.7.119 FE-FRCDWKSWBK-SPAN

Default Severity: Not Alarmed (NA), Non-Service-Affecting (NSA)

SONET Logical Object: OCN

The Far End Forced Switch Back to Working—Span condition is raised on a far-end 1+1 protect port when it is Force switched to the working port.



Note

WKSWBK-type conditions apply only to nonrevertive circuits.

Clear the FE-FRCDWKSWBK-SPAN Condition

-
- Step 1** Complete the [“Clear a 1+1 Force or Manual Switch Command” procedure on page 2-264](#) for the far-end port.
 - Step 2** If the condition does not clear, log into the Technical Support Website at <http://www.cisco.com/techsupport> for more information or call Cisco TAC 1 800 553-2447.
-

2.7.120 FE-FRCDWKSWPR-RING

Default Severity: Not Alarmed (NA), Non-Service-Affecting (NSA)

SONET Logical Object: EC1, OCN

The Far End Ring Working Facility Forced to Switch to Protection condition occurs from a far-end node when a BLSR is forced from working to protect using the Force Ring command. This condition is only visible on the network view Conditions tab.

Clear the FE-FRCDWKSWPR-RING Condition

-
- Step 1** To troubleshoot an FE condition, determine which node and card link directly to the card reporting the FE alarm. For example, an FE-AIS condition from the OC-48 card in Slot 12 of Node 1 could link to the main AIS condition from an OC-48 card in Slot 6 of Node 2.
 - Step 2** Log into the node that links directly to the card reporting the FE condition.
 - Step 3** Clear the main alarm.
 - Step 4** If the FE-FRCDWKSWPR-RING condition does not clear, complete the [“Clear a BLSR External Switching Command” procedure on page 2-270](#).
 - Step 5** If the condition does not clear, log into the Technical Support Website at <http://www.cisco.com/techsupport> for more information or call Cisco TAC 1 800 553-2447.
-

2.7.121 FE-FRCDWKSWPR-SPAN

Default Severity: Not Alarmed (NA), Non-Service-Affecting (NSA)

SONET Logical Object: OCN

The Far End Working Facility Forced to Switch to Protection Span condition occurs from a far-end node when a span on a four-fiber BLSR is forced from working to protect using the Force Span command. This condition is only visible on the network view Conditions tab. The port where the Force Switch occurred is indicated by an “F” on the network view detailed circuit map. This condition is accompanied by WKSWPR.

Clear the FE-FRCDWKSWPR-SPAN Condition

-
- Step 1** To troubleshoot an FE condition, determine which node and card link directly to the card reporting the FE alarm. For example, an FE-AIS condition from the OC-48 card in Slot 12 of Node 1 could link to the main AIS condition from an OC-48 card in Slot 6 of Node 2.
 - Step 2** Log into the node that links directly to the card reporting the FE condition.
 - Step 3** Clear the main alarm.
 - Step 4** If the FE-FRCDWKSWPR-SPAN condition does not clear, complete the [“Clear a BLSR External Switching Command” procedure on page 2-270](#).
 - Step 5** If the condition does not clear, log into the Technical Support Website at <http://www.cisco.com/techsupport> for more information or call Cisco TAC 1 800 553-2447.
-

2.7.122 FE-IDLE

Default Severity: Not Alarmed (NA), Non-Service-Affecting (NSA)

SONET Logical Object: DS3

The Far End Idle condition occurs when a far-end node detects an idle DS-3 signal in C-bit framing mode.

Clear the FE-IDLE Condition

-
- Step 1** To troubleshoot the FE condition, determine which node and card link directly to the card reporting the FE condition. For example, an FE condition on a card in Slot 12 of Node 1 could relate to a main alarm from a card in Slot 6 of Node 2.
 - Step 2** Log into the node that links directly to the card reporting the FE condition.
 - Step 3** Clear the main alarm by clearing the protection switch. See the “[2.9.2 Protection Switching, Lock Initiation, and Clearing](#)” section on page 2-262 for commonly used traffic-switching procedures.
 - Step 4** If the condition does not clear, log into the Technical Support Website at <http://www.cisco.com/techsupport> for more information or call Cisco TAC 1 800 553-2447.
-

2.7.123 FE-LOCKOUTOFPR-SPAN

Default Severity: Not Alarmed (NA), Non-Service-Affecting (NSA)

SONET Logical Object: OCN

The Far-End Lock Out of Protection Span condition occurs when a BSLR span is locked out of the protection system from a far-end node using the Lockout Protect Span command. This condition is only seen on the network view Conditions tab and is accompanied by LKOUTPR-S. The port where the lockout originated is marked by an “L” on the network view detailed circuit map.

Clear the FE-LOCKOUTOFPR-SPAN Condition

-
- Step 1** To troubleshoot an FE condition, determine which node and card link directly to the card reporting the FE alarm. For example, an FE-AIS condition from the OC-48 card in Slot 12 of Node 1 could link to the main AIS condition from an OC-48 card in Slot 6 of Node 2.
 - Step 2** Log into the node that links directly to the card reporting the FE condition.
 - Step 3** Ensure there is no lockout set. Complete the “[Clear a BLSR External Switching Command](#)” procedure on page 2-270.
 - Step 4** If the condition does not clear, log into the Technical Support Website at <http://www.cisco.com/techsupport> for more information or call Cisco TAC 1 800 553-2447.
-

2.7.124 FE-LOF

Default Severity: Not Alarmed (NA), Non-Service-Affecting (NSA)

SONET Logical Object: DS3

The Far End LOF condition occurs when a far-end node reports the “[LOF \(DS3\)](#)” alarm on page 2-150 in C-bit framing mode.

Clear the FE-LOF Condition

-
- Step 1** To troubleshoot an FE condition, determine which node and card link directly to the card reporting the FE condition. For example, an FE condition on a card in Slot 12 of Node 1 could relate to a main alarm from a card in Slot 6 of Node 2.
 - Step 2** Log into the node that links directly to the card reporting the FE condition.
 - Step 3** Complete the [“Clear the LOF \(DS1\) Alarm” procedure on page 2-149](#). It also applies to FE-LOF.
 - Step 4** If the condition does not clear, log into the Technical Support Website at <http://www.cisco.com/techsupport> for more information or call Cisco TAC 1 800 553-2447.
-

2.7.125 FE-LOS

Default Severity: Not Alarmed (NA), Non-Service-Affecting (NSA)

SONET Logical Object: DS3

The Far End LOS condition occurs in C-bit framing mode when a far-end node reports the [“LOS \(DS3\)” alarm on page 2-160](#).

Clear the FE-LOS Condition

-
- Step 1** To troubleshoot the FE condition, determine which node and card link directly to the card reporting the FE condition. For example, an FE condition on a card in Slot 12 of Node 1 could relate to a main alarm from a card in Slot 6 of Node 2.
 - Step 2** Log into the node that links directly to the card reporting the FE condition.
 - Step 3** Complete the [“Clear the LOS \(DS1\) Alarm” procedure on page 2-159](#).
 - Step 4** If the condition does not clear, log into the Technical Support Website at <http://www.cisco.com/techsupport> for more information or call Cisco TAC 1 800 553-2447.
-

2.7.126 FE-MANWKSWBK-SPAN

Default Severity: Not Alarmed (NA), Non-Service-Affecting (NSA)

SONET Logical Object: OCN

The Far End Manual Switch Back to Working—Span condition occurs when a far-end span with a Manual switch reverts to working.



Note

WKSWBK-type conditions such as FE-MANWKSWBK-SPAN apply only to nonrevertive spans.

Clear the FE-MANWKSWBK-SPAN Condition

-
- Step 1** To troubleshoot the FE condition, determine which node and card link directly to the card reporting the FE condition. For example, an FE condition on a card in Slot 12 of Node 1 could relate to a main alarm from a card in Slot 6 of Node 2.
 - Step 2** Log into the node that links directly to the card reporting the FE condition.
 - Step 3** Complete the [“Clear a BLSR External Switching Command” procedure on page 2-270](#).
 - Step 4** If the condition does not clear, log into the Technical Support Website at <http://www.cisco.com/techsupport> for more information or call Cisco TAC 1 800 553-2447.
-

2.7.127 FE-MANWKSWPR-RING

Default Severity: Not Alarmed (NA), Non-Service-Affecting (NSA)

SONET Logical Object: EC1, OCN

The Far End Ring Manual Switch of Working Facility to Protect condition occurs when a BLSR working ring is switched from working to protect at a far-end node using the Manual Ring command.

Clear the FE-MANWKSWPR-RING Condition

-
- Step 1** To troubleshoot an FE condition, determine which node and card link directly to the card reporting the FE alarm. For example, an FE-AIS condition from the OC-48 card in Slot 12 of Node 1 could link to the main AIS condition from an OC-48 card in Slot 6 of Node 2.
 - Step 2** Log into the node that links directly to the card reporting the FE condition.
 - Step 3** Complete the [“Clear a BLSR External Switching Command” procedure on page 2-270](#).
 - Step 4** If the condition does not clear, log into the Technical Support Website at <http://www.cisco.com/techsupport> for more information or call Cisco TAC 1 800 553-2447.
-

2.7.128 FE-MANWKSWPR-SPAN

Default Severity: Not Alarmed (NA), Non-Service-Affecting (NSA)

SONET Logical Object: OCN

The Far-End Span Manual Switch Working Facility to Protect condition occurs when a four-fiber BLSR span is switched from working to protect at the far-end node using the Manual Span command. This condition is only visible on the network view Conditions tab and is accompanied by WKSWPR. The port where the Manual Switch occurred is indicated by an “M” on the network view detailed circuit map.

Clear the FE-MANWKSWPR-SPAN Condition

-
- Step 1** To troubleshoot an FE condition, determine which node and card link directly to the card reporting the FE alarm. For example, an FE-AIS condition from the OC-48 card in Slot 12 of Node 1 could link to the main AIS condition from an OC-48 card in Slot 6 of Node 2.
 - Step 2** Log into the node that links directly to the card reporting the FE condition.
 - Step 3** Complete the “[Clear a BLSR External Switching Command](#)” procedure on page 2-270.
 - Step 4** If the condition does not clear, log into the Technical Support Website at <http://www.cisco.com/techsupport> for more information or call Cisco TAC 1 800 553-2447.
-

2.7.129 FEPRLF

Default Severity: Minor (MN), Non-Service-Affecting (NSA)

SONET Logical Object: OCN

The Far End Protection Line Failure alarm occurs when an APS channel “[SF-L](#)” condition on page 2-224 occurs on the protect card coming into the node.



Note

The FEPRLF alarm occurs when bidirectional protection is used on optical cards in a 1+1 protection group configuration or four-fiber BLSR configuration.

Clear the FEPRLF Alarm on a Four-Fiber BLSR

-
- Step 1** To troubleshoot the FE alarm, determine which node and card link directly to the card reporting the FE alarm. For example, an FE condition on a card in Slot 12 of Node 1 could relate to a main alarm from a card in Slot 6 of Node 2.
 - Step 2** Log into the node that links directly to the card reporting the FE condition.
 - Step 3** Clear the main alarm. Refer to the appropriate alarm section in this chapter in this chapter for procedures.
 - Step 4** If the alarm does not clear, log into the Technical Support Website at <http://www.cisco.com/techsupport> for more information or call Cisco TAC 1 800 553-2447.
-

2.7.130 FIBERTEMP-DEG

For information about this alarm or condition, refer to the “Alarm Troubleshooting” chapter in the *Cisco ONS 15454 DWDM Troubleshooting Guide*. This guide discusses all DWDM alarms.

2.7.131 FORCED-REQ

Default Severity: Not Alarmed (NA), Non-Service-Affecting (NSA)

SONET Logical Objects: EQPT, ML1000, ML100T, MLFX, STSMON, VT-MON

The Force Switch Request on Facility or Port condition occurs when you enter the Force command on a port to force traffic from a working port to a protect port or protection span (or from a protect port to a working port or span). You do not need to clear the condition if you want the Force switch to remain.

FORCED-REQ is raised for an IEEE 802.17b-based RPR span if the force was requested in the Cisco IOS CLI using the “rpr-ieee protection request force-switch {east | west}” command. It clears from the IEEE 802.17b-based RPR span when you remove the switch in the CLI. For the IEEE 802.17b-based RPR interface, FORCED-REQ is suppressed by the “RPR-PASSTHR” alarm on page 2-210. It also suppresses the following alarms:

- MAN-REQ, page 179
- RPR-SF, page 215
- RPR-SD, page 214
- WTR, page 259

Clear the FORCED-REQ Condition

-
- Step 1** If the condition is raised on a SONET entity, complete the “[Clear a 1+1 Force or Manual Switch Command](#)” procedure on page 2-264.
- Step 2** If the condition is raised on an IEEE-802.17b-based RPR span, enter the following command in the CLI in RPR-IEEE interface configuration mode:
- ```
router(config-if)#no rpr-ieee protection request force-switch {east | west}
```
- Step 3** If the condition does not clear, log into the Technical Support Website at <http://www.cisco.com/techsupport> for more information or call Cisco TAC 1 800 553-2447.
- 

## 2.7.132 FORCED-REQ-RING

Default Severity: Not Alarmed (NA), Non-Service-Affecting (NSA)

SONET Logical Object: OCN

The Force Switch Request Ring condition applies to optical trunk cards when the Force Ring command is applied to BLSRs to move traffic from working to protect. This condition is visible on the network view Alarms, Conditions, and History tabs and is accompanied by the “[WKSWPR](#)” alarm on page 2-258. The port where the FORCE RING command originated is marked with an “F” on the network view detailed circuit map.

## Clear the FORCED-REQ-RING Condition

- 
- Step 1** Complete the “[Clear a BLSR External Switching Command](#)” procedure on page 2-270.
- Step 2** If the condition does not clear, log into the Technical Support Website at <http://www.cisco.com/techsupport> for more information or call Cisco TAC 1 800 553-2447.
-

## 2.7.133 FORCED-REQ-SPAN

Default Severity: Not Alarmed (NA), Non-Service-Affecting (NSA)

SONET Logical Object: EC1, OCN

DWDM Logical Objects: 2R, ESCON, FC, GE, ISC, TRUNK

The Force Switch Request Span condition can apply to optical trunk cards in two-fiber or four-fiber BLSRs when the Force Span command is applied to a BLSR SPAN to force traffic from working to protect or from protect to working. This condition appears on the network view Alarms, Conditions, and History tabs. The port where the FORCE SPAN command was applied is marked with an “F” on the network view detailed circuit map.

FORCED-REQ can be raised in 1+1 facility protection groups. If traffic is present on a working port and you use the FORCE command to prevent it from switching to the protect port (indicated by “FORCED TO WORKING”), FORCED-REQ-SPAN indicates this force switch. In this case, the force is affecting not only the facility, but the span.

### Clear the FORCED-REQ-SPAN Condition

- 
- Step 1** Complete the “[Clear a BLSR External Switching Command](#)” procedure on page 2-270.
- Step 2** If the condition does not clear, log into the Technical Support Website at <http://www.cisco.com/techsupport> for more information or call Cisco TAC 1 800 553-2447.
- 

## 2.7.134 FP-LINK-LOSS

Default Severity: Minor (MN), Non-Service-Affecting (NSA)

SONET Logical Object: EQPT

The Front Port Link Loss condition occurs when a LAN cable is not connected to the front port of the TCC2/TCC2P card.

### Clear the FP-LINK-LOSS Condition

- 
- Step 1** Connect a LAN cable to the front port of the TCC2/TCC2P card.
- Step 2** If the condition does not clear, log into the Technical Support Website at <http://www.cisco.com/techsupport> for more information or call Cisco TAC 1 800 553-2447.
- 

## 2.7.135 FRCDSWTOINT

Default Severity: Not Alarmed (NA), Non-Service-Affecting (NSA)

SONET Logical Object: NE-SREF

The Force Switch to Internal Timing condition occurs when the user issues a FORCE command to switch to an internal timing source.



**Note**

---

FRCDSWTOINT is an informational condition and does not require troubleshooting.

---

## 2.7.136 FRCDSWTOPRI

Default Severity: Not Alarmed (NA), Non-Service-Affecting (NSA)

SONET Logical Objects: EXT-SREF, NE-SREF

The Force Switch to Primary Timing Source condition occurs when the user issues a FORCE command to switch to the primary timing source.

**Note**

---

FRCDSWTOPRI is an informational condition and does not require troubleshooting.

---

## 2.7.137 FRCDSWTOSEC

Default Severity: Not Alarmed (NA), Non-Service-Affecting (NSA)

SONET Logical Objects: EXT-SREF, NE-SREF

The Force Switch to Second Timing Source condition occurs when the user issues a FORCE command to switch to the second timing source.

**Note**

---

FRCDSWTOSEC is an informational condition and does not require troubleshooting.

---

## 2.7.138 FRCDSWTOHIRD

Default Severity: Not Alarmed (NA), Non-Service-Affecting (NSA)

SONET Logical Objects: EXT-SREF, NE-SREF

The Force Switch to Third Timing Source condition occurs when the user issues a Force command to switch to a third timing source.

**Note**

---

FRCDSWTOHIRD is an informational condition and does not require troubleshooting.

---

## 2.7.139 FRNGSYNC

Default Severity: Not Alarmed (NA), Non-Service-Affecting (NSA)

SONET Logical Object: NE-SREF

The Free Running Synchronization Mode condition occurs when the reporting ONS 15454 is in free-run synchronization mode. External timing sources have been disabled and the node is using its internal clock, or the node has lost its designated building integrated timing supply (BITS) timing source. After the 24-hour holdover period expires, timing slips could begin to occur on an ONS 15454 node relying on an internal clock.

**Note**

---

If the ONS 15454 is configured to operate from its internal clock, disregard the FRNGSYNC condition.

---

## Clear the FRNGSYNC Condition

- 
- Step 1** If the ONS 15454 is configured to operate from an external timing source, verify that the BITS timing source is valid. Common problems with a BITS timing source include reversed wiring and bad timing cards. Refer to the “Timing” chapter in the *Cisco ONS 15454 Reference Manual* for more information.
- Step 2** If the BITS source is valid, clear alarms related to the failures of the primary and secondary reference sources, such as the “SYNCPRI” alarm on page 2-242 and the “SYNCSEC” alarm on page 2-242.
- Step 3** If the condition does not clear, log into the Technical Support Website at <http://www.cisco.com/techsupport> for more information or call Cisco TAC 1 800 553-2447.
- 

## 2.7.140 FSTSYNC

Default Severity: Not Alarmed (NA), Non-Service-Affecting (NSA)

SONET Logical Object: NE-SREF

A Fast Start Synchronization Mode condition occurs when the node is choosing a new timing reference. The previous timing reference has failed.

The FSTSYNC alarm disappears after approximately 30 seconds. If the condition does not clear, log into the Technical Support Website at <http://www.cisco.com/techsupport> for more information or call Cisco TAC 1 800 553-2447.

**Note**

---

FSTSYNC is an informational condition. It does not require troubleshooting.

---

## 2.7.141 FTA-MISMATCH

For information about this alarm or condition, refer to the “Alarm Troubleshooting” chapter in the *Cisco ONS 15454 DWDM Troubleshooting Guide*. This guide discusses all DWDM alarms.

## 2.7.142 FULLPASSTHR-BI

Default Severity: Not Alarmed (NA), Non-Service-Affecting (NSA)

SONET Logical Object: OCN

The Bidirectional Full Pass-Through Active condition occurs on a nonswitching node in a BLSR when the protect channels on the node are active and carrying traffic and there is a change in the receive K byte from No Request.

## Clear the FULLPASSTHR-BI Condition

- 
- Step 1** Complete the “[Clear a BLSR External Switching Command](#)” procedure on page 2-270.
- Step 2** If the condition does not clear, log into the Technical Support Website at <http://www.cisco.com/techsupport> for more information or call Cisco TAC 1 800 553-2447.
- 

## 2.7.143 GAIN-HDEG

For information about this alarm or condition, refer to the “Alarm Troubleshooting” chapter in the *Cisco ONS 15454 DWDM Troubleshooting Guide*. This guide discusses all DWDM alarms.

## 2.7.144 GAIN-HFAIL

For information about this alarm or condition, refer to the “Alarm Troubleshooting” chapter in the *Cisco ONS 15454 DWDM Troubleshooting Guide*. This guide discusses all DWDM alarms.

## 2.7.145 GAIN-LDEG

For information about this alarm or condition, refer to the “Alarm Troubleshooting” chapter in the *Cisco ONS 15454 DWDM Troubleshooting Guide*. This guide discusses all DWDM alarms.

## 2.7.146 GAIN-LFAIL

For information about this alarm or condition, refer to the “Alarm Troubleshooting” chapter in the *Cisco ONS 15454 DWDM Troubleshooting Guide*. This guide discusses all DWDM alarms.

## 2.7.147 GCC-EOC

For information about this alarm or condition, refer to the “Alarm Troubleshooting” chapter in the *Cisco ONS 15454 DWDM Troubleshooting Guide*. This guide discusses all DWDM alarms.

## 2.7.148 GE-OOSYNC

For information about this alarm or condition, refer to the “Alarm Troubleshooting” chapter in the *Cisco ONS 15454 DWDM Troubleshooting Guide*. This guide discusses all DWDM alarms.

## 2.7.149 GFP-CSF

Default Severity: Major (MJ), Service-Affecting (SA)

SONET Logical Objects: CE1000, CE100T, FCMR, GFP-FAC, ML1000, ML100T, MLFX

The GFP Client Signal Fail Detected alarm is a secondary alarm raised on local GFP data ports when a remote Service-Affecting (SA) alarm causes invalid data transmission. The alarm is raised locally on FC\_MR-4, ML100T, ML1000, ML100X-8, MXP\_MR\_25G, and MXPP\_MR\_25G GFP data ports and does not indicate that a Service-Affecting (SA) failure is occurring at the local site, but that a CARLOSS, LOS, or SYNCLOSS alarm caused by an event such as a pulled receive cable is affecting a remote data port's transmission capability. This alarm can be demoted when a facility loopback is placed on the FC\_MR-4 port.

**Note**

For more information about provisioning MXP or TXP cards, refer to the *Cisco ONS 15454 DWDM Reference Manual*. For more information about Ethernet cards, refer to the *Cisco ONS 15454 and Cisco ONS 15454 SDH Ethernet Card Software Feature and Configuration Guide*.

## Clear the GFP-CSF Alarm

- 
- Step 1** Clear the Service-Affecting (SA) alarm at the remote data port.
- Step 2** If the GFP-CSF alarm does not clear, log into the Technical Support Website at <http://www.cisco.com/techsupport> for more information or call Cisco TAC 1 800 553-2447 to report a Service-Affecting (SA) problem.
- 

## 2.7.150 GFP-DE-MISMATCH

Default Severity: Major (MJ), Service-Affecting (SA)

SONET Logical Objects: FCMR, GFP-FAC

The GFP Fibre Channel Distance Extension Mismatch alarm indicates that a port configured for Distance Extension is connected to a port that is not operating in Cisco's proprietary Distance Extension mode. It is raised on Fibre Channel and FICON card GFP ports supporting distance extension. The alarm occurs when distance extension is enabled on one side of the transport but not on the other. To clear, distance extension must be enabled on both ports connected by a circuit.

**Note**

For more information about Ethernet cards, refer to the *Cisco ONS 15454 and Cisco ONS 15454 SDH Ethernet Card Software Feature and Configuration Guide*.

## Clear the GFP-DE-MISMATCH Alarm

- 
- Step 1** Ensure that the distance extension protocol is configured correctly on both sides:
- a. Double-click the card to open the card view.
  - b. Click the **Provisioning > Port > General** tabs.
  - c. Under Admin State, click the cell and choose **OOS,MT**.
  - d. Click **Apply**.
  - e. Click the **Provisioning > Port > Distance Extension** tabs.
  - f. Check the check box in the **Enable Distance Extension** column.

- g. Click **Apply**.
- h. Click the **Provisioning > Port > General** tabs.
- i. Under Admin State, click the cell and choose **IS**.
- j. Click **Apply**.



---

**Note** If ports managed into IS admin state are not receiving signals, the LOS alarm is either raised or remains, and the port service state transitions to OOS-AU,FLT.

---

- Step 2** If the GFP-DE-MISMATCH alarm does not clear, log into the Technical Support Website at <http://www.cisco.com/techsupport> for more information or call Cisco TAC 1 800 553-2447 to report a Service-Affecting (SA) problem.
- 

## 2.7.151 GFP-EX-MISMATCH

Default Severity: Major (MJ), Service-Affecting (SA)

SONET Logical Objects: CE1000, FCMR, GFP-FAC

The GFP Extension Header Mismatch alarm is raised on Fibre Channel/FICON cards when it receives frames with an extension header that is not null. The alarm occurs when a provisioning error causes all GFP frames to be dropped for 2.5 seconds.

Ensure that both end ports are sending a null extension header for a GFP frame. The FC\_MR-4 card always sends a null extension header, so if the equipment is connected to other vendors' equipment, those need to be provisioned appropriately.



---

**Note** For more information about Ethernet cards, refer to the *Cisco ONS 15454 and Cisco ONS 15454 SDH Ethernet Card Software Feature and Configuration Guide*.

---

### Clear the GFP-EX-MISMATCH Alarm

- Step 1** Ensure that the vendor equipment is provisioned to send a null extension header in order to interoperate with the FC\_MR-4 card. (The FC\_MR-4 card always sends a null extension header.)
- Step 2** If the GFP-EX-MISMATCH alarm does not clear, log into the Technical Support Website at <http://www.cisco.com/techsupport> for more information or call Cisco TAC 1 800 553-2447 to report a Service-Affecting (SA) problem.
- 

## 2.7.152 GFP-LFD

Default Severity: Major (MJ), Service-Affecting (SA)

SONET Logical Objects: CE1000, CE100T, FCMR, GFP-FAC, ML1000, ML100T, MLFX

The GFP Loss of Frame Delineation alarm applies to Fibre Channel, FICON GFP, and Ethernet ports. This alarm occurs if there is a faulty SONET connection, if SONET path errors cause GFP header errors in the check sum calculated over payload length (PLI/chech) combination, or if the GFP source port sends an invalid PLI/chech combination. This loss causes traffic stoppage.

**Note**

For more information about Ethernet cards, refer to the *Cisco ONS 15454 and Cisco ONS 15454 SDH Ethernet Card Software Feature and Configuration Guide*.

## Clear the GFP-LFD Alarm

- 
- Step 1** Look for and clear any associated SONET path errors such as LOS or AIS-L originating at the transmit node.
- Step 2** If the GFP-LFD alarm does not clear, log into the Technical Support Website at <http://www.cisco.com/techsupport> for more information or call Cisco TAC 1 800 553-2447 to report a Service-Affecting (SA) problem.
- 

## 2.7.153 GFP-NO-BUFFERS

Default Severity: Major (MJ), Service-Affecting (SA)

SONET Logical Objects: FCMR, GFP-FAC

The GFP Fibre Channel Distance Extension Buffer Starvation alarm is raised on Fibre Channel/FICON card ports supporting GFP and the distance extension protocol when the GFP transmitter cannot send GFP frames due to lack of remote GFP receiver buffers. This occurs when the remote GFP-T receiver experiences congestion and is unable to send frames over the Fibre Channel/FICON link.

This alarm could be raised in conjunction with the “[FC-NO-CREDITS](#)” alarm on page 2-101. For example, if the FC-NO-CREDITS alarm is generated at an FC\_MR-4 data port, a GFP-NO-BUFFERS alarm could be raised at the upstream remote FC\_MR-4 data port.

**Note**

For more information about Ethernet cards, refer to the *Cisco ONS 15454 and Cisco ONS 15454 SDH Ethernet Card Software Feature and Configuration Guide*.

## Clear the GFP-NO-BUFFERS Alarm

- 
- Step 1** Complete the “[Clear the FC-NO-CREDITS Alarm](#)” procedure on page 2-102.
- Step 2** If the GFP-CSF alarm does not clear, log into the Technical Support Website at <http://www.cisco.com/techsupport> for more information or call Cisco TAC (1 800 553-2447) to report a Service-Affecting (SA) problem.
-

## 2.7.154 GFP-UP-MISMATCH

Default Severity: Major (MJ), Service-Affecting (SA)

SONET Logical Objects: CE1000, CE100T, FCMR, GFP-FAC, ML1000, ML100T, MLFX

The GFP User Payload Mismatch is raised against Fibre Channel/FICON ports supporting GFP. It occurs when the received frame user payload identifier (UPI) does not match the transmitted UPI and all frames are dropped. The alarm is caused by a provisioning error, such as the port media type not matching the remote port media type. For example, the local port media type could be set to Fibre Channel—1 Gbps ISL or Fibre Channel—2 Gbps ISL and the remote port media type could be set to FICON—1 Gbps ISL or FICON—2 Gbps ISL.

**Note**

For more information about Ethernet cards, refer to the *Cisco ONS 15454 and Cisco ONS 15454 SDH Ethernet Card Software Feature and Configuration Guide*.

### Clear the GFP-UP-MISMATCH Alarm

- 
- Step 1** Ensure that the transmit port and receive port are identically provisioned for distance extension by completing the following steps:
- Double-click the card to open the card view.
  - Click the **Provisioning > Port > Distance Extension** tabs.
  - Check the check box in the **Enable Distance Extension** column.
  - Click **Apply**.
- Step 2** Ensure that both ports are set for the correct media type. For each port, complete the following steps:
- Double-click the card to open the card view (if you are not already in card view).
  - Click the **Provisioning > Port > General** tabs.
  - Choose the correct media type (**Fibre Channel - 1Gbps ISL**, **Fibre Channel - 2 Gbps ISL**, **FICON - 1 Gbps ISL**, or **FICON - 2 Gbps ISL**) from the drop-down list.
  - Click **Apply**.
- Step 3** If the GFP-UP-MISMATCH alarm does not clear, log into the Technical Support Website at <http://www.cisco.com/techsupport> for more information or call Cisco TAC 1 800 553-2447 to report a Service-Affecting (SA) problem.
- 

## 2.7.155 HELLO

Default Severity: Minor (MN), Non-Service-Affecting (NSA)

SONET Logical Object: OCN

DWDM Logical Object: TRUNK

The Open Shortest Path First (OSPF) Hello alarm is raised when the two end nodes cannot bring an OSPF neighbor up to the full state. Typically, this problem is caused by an area ID mismatch, and/or an OSPF HELLO packet loss over the DCC.

## Clear the HELLO Alarm

---

- Step 1** Ensure that the area ID is correct on the missing neighbor:
- In node view, click the **Provisioning > Network > OSPF** tabs.
  - Ensure that the IP address in the Area ID column matches the other nodes.
  - If the address does not match, click the incorrect cell and correct it.
  - Click **Apply**.
- Step 2** If the alarm does not clear, log into the Technical Support Website at <http://www.cisco.com/techsupport> for more information or call Cisco TAC 1 800 553-2447.
- 

## 2.7.156 HIBATVG

Default Severity: Major (MJ), Service-Affecting (SA)

SONET Logical Object: PWR

The High Voltage Battery alarm occurs in a –48 VDC environment when a battery lead input voltage exceeds the high power threshold. This threshold, with a default value of –52 VDC, is user-provisionable. The alarm remains raised until the voltage remains under the threshold for 120 seconds. (For information about changing this threshold, refer to the “Turn Up Node” chapter in the *Cisco ONS 15454 Procedure Guide*.)

## Clear the HIBATVG Alarm

---

- Step 1** The problem is external to the ONS 15454. Troubleshoot the power source supplying the battery leads.
- Step 2** If the alarm does not clear, log into the Technical Support Website at <http://www.cisco.com/techsupport> for more information or call Cisco TAC 1 800 553-2447 in order to report a Service-Affecting (SA) problem.
- 

## 2.7.157 HI-CCVOLT

Default Severity: Not Alarmed (NA), Non-Service-Affecting (NSA)

SONET Logical Object: BITS

The 64K Composite Clock High NE Voltage alarm occurs when the 64K signal peak voltage exceeds 1.1 VDC.

## Clear the HI-CCVOLT Condition

---

- Step 1** Lower the source voltage to the clock.
- Step 2** If the condition does not clear, add more cable length or add a 5 dBm attenuator to the cable.



- Step 3** If the alarm does not clear, log into the Technical Support Website at <http://www.cisco.com/techsupport> for more information or call Cisco TAC 1 800 553-2447 in order to report a Service-Affecting (SA) problem.
- 

## 2.7.158 HI-LASERBIAS

Default Severity: Minor (MN), Non-Service-Affecting (NSA)

SONET Logical Objects: EQPT, OCN

DWDM Logical Objects: 2R, ESCON, FC, GE, ISC, PPM, TRUNK

The Equipment High Transmit Laser Bias Current alarm is raised against TXP\_MR\_10G, TXP\_MR\_2.5G, TXPP\_MR\_2.5G, TXP\_MR\_10E, MXP\_2.5G\_10G, MRC-12, MRC-4, and OC192-XFP card laser performance. The alarm indicates that the card laser has reached the maximum laser bias tolerance.

Laser bias typically starts at about 30 percent of the manufacturer maximum laser bias specification and increases as the laser ages. If the HI-LASERBIAS alarm threshold is set at 100 percent of the maximum, the laser usability has ended. If the threshold is set at 90 percent of the maximum, the card is still usable for several weeks or months before it needs to be replaced.



### Note

For more information about provisioning MXP or TXP PPMs, refer to the “Provision Transponders and Muxponders” chapter of the *Cisco ONS 15454 DWDM Procedure Guide*. For more information about the cards themselves, refer to the *Cisco ONS 15454 DWDM Reference Manual*.

---

## Clear the HI-LASERBIAS Alarm

- Step 1** Complete the “[Clear the LASEREOL Alarm](#)” procedure on page 2-138, which can include replacing the card. Replacement is not urgent and can be scheduled during a maintenance window.



### Caution

Removing an active card can cause a traffic hit. To avoid this, perform an external switch if a switch has not already occurred. See the “[2.9.2 Protection Switching, Lock Initiation, and Clearing](#)” section on page 2-262 for commonly used traffic-switching procedures.

---

- Step 2** If the alarm does not clear, log into the Technical Support Website at <http://www.cisco.com/techsupport> for more information or call Cisco TAC 1 800 553-2447.
- 

## 2.7.159 HI-LASERTEMP

Default Severity: Minor (MN), Non-Service-Affecting (NSA)

SONET Logical Objects: EQPT, OCN

DWDM Logical Object: PPM

The Equipment High Laser Optical Transceiver Temperature alarm applies to the TXP and MXP cards. HI-LASERTEMP occurs when the internally measured transceiver temperature exceeds the card setting by 35.6 degrees F (2 degrees C). A laser temperature change affects the transmitted wavelength.

When the TXP or MXP card raises this alarm, the laser is automatically shut off. The “LOS (OCN)” alarm on page 2-165 is raised at the far-end node and the “DUP-IPADDR” alarm on page 2-79 is raised at the near end.

**Note**

For more information about provisioning MXP or TXP PPMs, refer to the “Provision Transponder and Muxponder Cards” chapter of the *Cisco ONS 15454 DWDM Procedure Guide*. For more information about the cards themselves, refer to the *Cisco ONS 15454 DWDM Reference Manual*.

## Clear the HI-LASERTEMP Alarm

- 
- Step 1** In node view, double-click the TXP or MXP card to open the card view.
  - Step 2** Click the **Performance > Optics PM > Current Values** tabs.
  - Step 3** Verify the card laser temperature levels. Maximum, minimum, and average laser temperatures are shown in the Current column entries in the Laser Temp rows.
  - Step 4** Complete the “Reset a Traffic Card in CTC” procedure on page 2-271 for the MXP or TXP card.
  - Step 5** If the alarm does not clear, complete the “Physically Replace a Traffic Card” procedure on page 2-274 for the reporting MXP or TXP card.
  - Step 6** If the alarm does not clear, log into the Technical Support Website at <http://www.cisco.com/techsupport> for more information or call Cisco TAC 1 800 553-2447.
- 

## 2.7.160 HI-RXPOWER

Default Severity: Minor (MN), Non-Service-Affecting (NSA)

SONET Logical Object: OCN

DWDM Logical Objects: 2R, ESCON, FC, GE, ISC, TRUNK

The Equipment High Receive Power alarm is an indicator of the optical signal power that is transmitted to the TXP\_MR\_10G, TXP\_MR\_2.5G, TXPP\_MR\_2.5G, TXP\_MR\_10E, MXP\_2.5G\_10G, MRC-12, MRC-4, or OC192-XFP card. HI-RXPOWER occurs when the measured optical power of the received signal exceeds the threshold. The threshold value is user-provisionable.

**Note**

For more information about MXP or TXP cards, refer to the *Cisco ONS 15454 DWDM Reference Manual*.

**Note**

When you upgrade a node to Software Release 6.0 or later, this enables received optical power PMs for the OC3-8, OC192-SR, OC192-IR, OC192-ITU, OC-192-XFP, MRC-12, and MRC25G-4 cards. The newly enabled HI-RXPOWER and LO-RXPOWER alarms require that you initialize a site-accepted optical power (OPRO) nominal value after the upgrade. (To do this, refer to the procedure in the “Turn

Up a Node” chapter in the *Cisco ONS 15454 Procedure Guide*.) When you apply the value change, CTC uses the new OPR0 value to calculate PM percentage values. If you do not change the nominal value, the HI-RXPOWER or LO-RXPOWER may be raised in response to the unmodified setting.

## Clear the HI-RXPOWER Alarm

- 
- Step 1** Find out whether gain (the amplification power) of any amplifiers has been changed. This change also causes channel power to need adjustment.
- Step 2** Find out whether channels have been dropped from the fiber. Increasing or decreasing channels can affect power. If channels have been dropped, the power levels of all channels have to be adjusted.
-  **Note** If the card is part of an amplified DWDM system, dropping channels on the fiber affects the transmission power of each channel more than it would in an unamplified system.
- 
- Step 3** At the transmit end of the errored circuit, decrease the transmit power level within safe limits.
- Step 4** If neither of these problems cause the HI-RXPOWER alarm, there is a slight possibility that another wavelength is drifting on top of the alarmed signal. In this case, the receiver gets signals from two transmitters at the same time and data alarms would be present. If wavelengths are drifting, the data is garbled and receive power increases by about +3 dBm.
- Step 5** If the alarm does not clear, add fiber attenuators to the receive ports. Start with low-resistance attenuators and use stronger ones as needed, depending on factors such as the transmission distance, according to standard practice.
- Step 6** If the alarm does not clear and no faults are present on the other port(s) of the transmit or receive card, use a known-good loopback cable to complete the “[1.6.1 Perform a Facility Loopback on a Source-Node FC\\_MR Port](#)” procedure on page 1-94 and test the loopback.
- Step 7** If a port is bad and you need to use all the port bandwidth, complete the “[Physically Replace a Traffic Card](#)” procedure on page 2-274. If the port is bad but you can move the traffic to another port, replace the card at the next available maintenance window.
- Step 8** If the alarm does not clear, log into the Technical Support Website at <http://www.cisco.com/techsupport> for more information or call Cisco TAC 1 800 553-2447.
- 

## 2.7.161 HITEMP

Default Severity: Critical (CR), Service-Affecting (SA) for NE; Default Severity: Minor (MN), Non-Service-Affecting (NSA) for EQPT

SONET Logical Objects: EQPT, NE

The High Temperature alarm occurs when the temperature of the ONS 15454 is above 122 degrees F (50 degrees C).

## Clear the HITEMP Alarm

- 
- Step 1** View the temperature displayed on the ONS 15454 LCD front panel ([Figure 2-2](#)).

Figure 2-2 Shelf LCD Panel

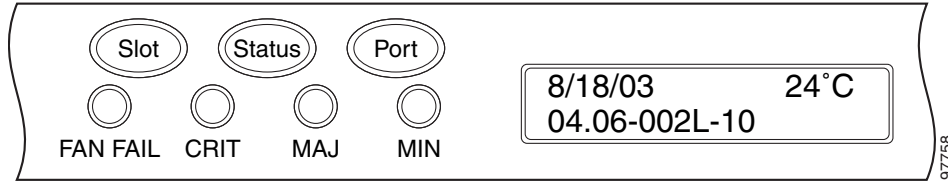

- Step 2** Verify that the environmental temperature of the room is not abnormally high.
- Step 3** If the room temperature is not abnormal, physically ensure that nothing prevents the fan-tray assembly from passing air through the ONS 15454 shelf.
- Step 4** If airflow is not blocked, physically ensure that blank faceplates fill the ONS 15454 shelf empty slots. Blank faceplates help airflow.
- Step 5** If faceplates fill the empty slots, determine whether the air filter needs replacement. Refer to the [“Inspect, Clean, and Replace the Reusable Air Filter” procedure on page 2-279](#).
- Step 6** If the fan does not run or the alarm persists, complete the [“Replace the Fan-Tray Assembly” procedure on page 2-281](#).



**Note** The fan should run immediately when correctly inserted.

- Step 7** If the replacement fan-tray assembly does not operate correctly, log into the Technical Support Website at <http://www.cisco.com/techsupport> for more information or call Cisco TAC to report a Service-Affecting (SA) problem 1 800 553-2447 if it applies to the NE, or a Non-Service-Affecting (NSA) problem if it applies to equipment.

## 2.7.162 HI-TXPOWER

Default Severity: Minor (MN), Non-Service-Affecting (NSA)

SONET Logical Objects: EQPT, OCN

DWDM Logical Objects: 2R, ESCON, FC, GE, ISC, PPM, TRUNK

The Equipment High Transmit Power alarm is an indicator on the TXP\_MR\_E, TXP\_MR\_10G, TXP\_MR\_2.5G, TXPP\_MR\_2.5G, MXP\_2.5G\_10G, MRC-12, MRC-4, or OC192-XFP card transmitted optical signal power. HI-TXPOWER occurs when the measured optical power of the transmitted signal exceeds the threshold.



**Note** For more information about provisioning MXP or TXP PPMs, refer to the “Provision Transponders and Muxponders” chapter of the *Cisco ONS 15454 DWDM Procedure Guide*. For more information about the cards themselves, refer to the *Cisco ONS 15454 DWDM Reference Manual*.

### Clear the HI-TXPOWER Alarm

- Step 1** In node view, double-click the card view for the TXP\_MR\_10E, TXP\_MR\_10G, TXP\_MR\_2.5G, TXPP\_MR\_2.5G, MXP\_2.5G\_10G, or OC192-XFP card.

- Step 2** Click the **Provisioning > Optics Thresholds > Current Values** tabs.
- Step 3** Decrease (change toward the negative direction) the OPT-HIGH column value by 0.5 dBm.
- Step 4** If the card transmit power setting cannot be lowered without disrupting the signal, complete the “[Physically Replace a Traffic Card](#)” section on page 2-274.
- Step 5** If the alarm does not clear, log into the Technical Support Website at <http://www.cisco.com/techsupport> for more information or call Cisco TAC 1 800 553-2447.
- 

## 2.7.163 HLDVRSYNC

Default Severity: Not Alarmed (NA), Non-Service-Affecting (NSA)

SONET Logical Object: NE-SREF

The Holdover Synchronization Mode condition is caused by loss of the primary and second timing references in the node. Timing reference loss occurs when line coding on the timing input is different from the configuration on the node, and it often occurs during the selection of a new node reference clock. The condition clears when primary or second timing is reestablished. After the 24-hour holdover period expires, timing slips could begin to occur on an ONS 15454 relying on an internal clock.

### Clear the HLDVRSYNC Condition

---

- Step 1** Clear additional alarms that relate to timing, such as:
- [2.7.139 FRNGSYNC](#), page 2-115
  - [2.7.140 FSTSYNC](#), page 2-116
  - [2.7.198 LOF \(BITS\)](#), page 2-148
  - [2.7.215 LOS \(BITS\)](#), page 2-158
  - [2.7.262 MANSWTOINT](#), page 2-179
  - [2.7.263 MANSWTOPRI](#), page 2-180
  - [2.7.264 MANSWTOSEC](#), page 2-180
  - [2.7.265 MANSWTOTHIRD](#), page 2-180
  - [2.7.401 SWTOPRI](#), page 2-239
  - [2.7.402 SWTOSEC](#), page 2-240
  - [2.7.403 SWTOTHIRD](#), page 2-240
  - [2.7.404 SYNC-FREQ](#), page 2-240
  - [2.7.406 SYNCPRI](#), page 2-242
  - [2.7.407 SYNCSEC](#), page 2-242
  - [2.7.408 SYNCTHIRD](#), page 2-243
- Step 2** Reestablish a primary and secondary timing source according to local site practice. If none exists, refer to the “Change Node Settings” chapter in the *Cisco ONS 15454 Procedure Guide*.

- Step 3** If the condition does not clear, log into the Technical Support Website at <http://www.cisco.com/techsupport> for more information or call Cisco TAC 1 800 553-2447 in order to report a Service-Affecting (SA) problem.
- 

## 2.7.164 I-HITEMP

Default Severity: Critical (CR), Service-Affecting (SA)

SONET Logical Object: NE

The Industrial High Temperature alarm occurs when the temperature of the ONS 15454 is above 149 degrees F (65 degrees C) or below –40 degrees F (–40 degrees C). This alarm is similar to the HITEMP alarm but is used for the industrial environment. If this alarm is used, you can customize your alarm profile to ignore the lower-temperature HITEMP alarm.

### Clear the I-HITEMP Alarm

- Step 1** Complete the “[Clear the HITEMP Alarm](#)” procedure on page 2-125.
- Step 2** If the alarm does not clear, log into the Technical Support Website at <http://www.cisco.com/techsupport> for more information or call TAC (1-800-553-2447) in order to report a Service-Affecting (SA) problem.
- 

## 2.7.165 ILK-FAIL

For information about this alarm or condition, refer to the “Alarm Troubleshooting” chapter in the *Cisco ONS 15454 DWDM Troubleshooting Guide*. This guide discusses all DWDM alarms.

## 2.7.166 IMPROPRMVL

Default Severity: Critical (CR), Service-Affecting (SA)

SONET Logical Object: EQPT

DWDM Logical Object: PPM

The Improper Removal equipment alarm occurs when a card is physically removed from its slot before it is deleted from CTC. The card does not need to be in service to cause the IMPROPRMVL alarm; it only needs to be recognized by CTC. The alarm does not appear if you delete the card from CTC before you physically remove the card from the node. It can also occur if the card is inserted into a slot but is not fully plugged into the backplane. For PPMs, the alarm occurs if you provision a PPM but no physical module is inserted on the port.



#### Caution

Do not remove a card during a card reboot. If CTC begins to reboot a card before you remove the card, allow the card to finish rebooting. After the card reboots, delete the card in CTC again and physically remove the card before it begins to reboot.

---

**Note**

CTC gives the user approximately 15 seconds to physically remove the card before CTC begins a card reboot.

**Note**

It can take up to 30 minutes for software to be updated on a standby TCC2/TCC2P.

## Clear the IMPROPRMVL Alarm

**Step 1** In node view, right-click the card reporting the IMPROPRMVL.

**Step 2** Choose **Delete** from the shortcut menu.

**Note**

CTC does not allow you to delete the reporting card if the card is in service, does have circuits mapped to it, is paired in a working protection scheme, has DCC enabled, or is used as a timing reference.

**Step 3** If any ports on the card are in service, place them out of service (OOS,MT):

**Caution**

Before placing a port out of service (OOS,MT or OOS,DSBLD), ensure that no live traffic is present.

- a. In node view, double-click the reporting card to open the card view.
- b. Click the **Provisioning > Line** tab.
- c. Click the Admin State column of any in-service (IS) ports.
- d. Choose **OOS,MT** to take the ports out of service.

**Step 4** If a circuit has been mapped to the card, complete the [“Delete a Circuit” procedure on page 2-276](#).

**Caution**

Before deleting the circuit, ensure that the circuit does not carry live traffic.

**Step 5** If the card is paired in a protection scheme, delete the protection group:

- a. Click **View > Go to Previous View** to return to node view.
- b. If you are already in node view, click the **Provisioning > Protection** tabs.
- c. Click the protection group of the reporting card.
- d. Click **Delete**.

**Step 6** If the card is provisioned for DCC, delete the DCC provisioning:

- a. Click the ONS 15454 **Provisioning > Comm Channels > SDCC** tabs.
- b. Click the slots and ports listed in DCC terminations.
- c. Click **Delete** and click **Yes** in the dialog box that appears.

**Step 7** If the card is used as a timing reference, change the timing reference:

- a. Click the **Provisioning > Timing > General** tabs.
- b. Under NE Reference, click the drop-down arrow for **Ref-1**.

- c. Change Ref-1 from the listed OC-N card to **Internal Clock**.
- d. Click **Apply**.

**Step 8** If the alarm does not clear, log into the Technical Support Website at <http://www.cisco.com/techsupport> for more information or call Cisco TAC 1 800 553-2447 in order to report a Service-Affecting (SA) problem.

---

## 2.7.167 INCOMPATIBLE-SEND-PDIP

Default Severity: Minor (MN), Non-Service-Affecting (NSA)

SONET Logical Object: SYSTEM

The Incompatible Software alarm is raised when the PDIP provisioning on CTC differs from the provisioning on the host node.

### Clear the INCOMPATIBLE-SEND-PDIP Alarm

---

**Step 1** Reconfigure the send-PDI-P-alarm capability in CTC to align with the host node settings.

**Step 2** If the alarm does not clear, log into the Technical Support Website at <http://www.cisco.com/techsupport> for more information or call TAC (1-800-553-2447).

---

## 2.7.168 INCOMPATIBLE-SW

Default Severity: Minor (MN), Non-Service-Affecting (NSA)

SONET Logical Object: SYSTEM

The Incompatible Software alarm is raised when CTC cannot connect to the NE due to incompatible versions of software between CTC and the NE. The alarm is cleared by restarting CTC in order to redownload the CTC jar files from the NE.

### Clear the INCOMPATIBLE-SW Alarm

---

**Step 1** Restart the CTC application.

**Step 2** If the alarm does not clear, log into the Technical Support Website at <http://www.cisco.com/techsupport> for more information or call TAC (1-800-553-2447).

---

## 2.7.169 INC-ISD

Default Severity: Not Alarmed (NA), Non-Service-Affecting (NSA)

SONET Logical Object: DS3



The DS-3 Idle condition indicates that the DS-3 card is receiving an idle signal, meaning that the payload of the signal contains a repeating pattern of bits. The INC-ISD condition occurs when the transmitting port has an OOS-MA,MT service state. It is resolved when the OOS-MA,MT state ends.

**Note**

INC-ISD is a condition and not an alarm. It is for information only and does not require troubleshooting.

## 2.7.170 INHSWPR

Default Severity: Not Alarmed (NA), Non-Service-Affecting (NSA)

SONET Logical Object: EQPT

The Inhibit Switch To Protect Request on Equipment condition occurs on traffic cards when the ability to switch to protect has been disabled. If the card is part of a 1:1 or 1+1 protection scheme, traffic remains locked onto the working system. If the card is part of a 1:N protection scheme, traffic can be switched between working cards when the switch to protect is disabled.

### Clear the INHSWPR Condition

- 
- Step 1** If the condition is raised against a 1+1 port, complete the [“Initiate a 1+1 Manual Switch Command” section on page 2-263](#).
  - Step 2** If the condition is raised against a 1:1 card, complete the [“Initiate a 1:1 Card Switch Command” procedure on page 2-265](#) to switch it back.
  - Step 3** If the condition does not clear, log into the Technical Support Website at <http://www.cisco.com/techsupport> for more information or call Cisco TAC 1 800 553-2447.
- 

## 2.7.171 INHSWWKG

Default Severity: Not Alarmed (NA), Non-Service-Affecting (NSA)

SONET Logical Object: EQPT

The Inhibit Switch To Working Request on Equipment condition occurs on traffic cards when the ability to switch to working has been disabled. If the card is part of a 1:1 or 1+1 protection scheme, traffic remains locked onto the protect system. If the card is part of a 1:N protection scheme, traffic can be switched between protect cards when the switch to working is disabled.

### Clear the INHSWWKG Condition

- 
- Step 1** If the condition is raised against a 1+1 port, complete the [“Initiate a 1+1 Manual Switch Command” section on page 2-263](#).
  - Step 2** If it is raised against a 1:1 card, complete the [“Initiate a 1:1 Card Switch Command” procedure on page 2-265](#) to switch traffic back.

- Step 3** If the condition does not clear, log into the Technical Support Website at <http://www.cisco.com/techsupport> for more information or call Cisco TAC 1 800 553-2447.
- 

## 2.7.172 INTRUSION-PSWD

Default Severity: Not Alarmed (NA), Non-Service-Affecting (NSA)

SONET Logical Object: NE

The Security Intrusion Incorrect Password condition occurs after a user attempts a provisionable (by Superuser) number of unsuccessful logins, a login with an expired password, or an invalid password. The alarmed user is locked out of the system, and INTRUSION-PSWD condition is raised. This condition is only shown in Superuser login sessions, not in login sessions for lower-level users. The INTRUSION-PSWD condition is automatically cleared when a provisionable lockout timeout expires, or it can be manually cleared in CTC by the Superuser if the lockout is permanent.

### Clear the INTRUSION-PSWD Condition

---

- Step 1** Click the **Provisioning > Security > Users** tabs.
- Step 2** Click **Clear Security Intrusion Alarm**.
- Step 3** If the condition does not clear, log into the Technical Support Website at <http://www.cisco.com/techsupport> for more information or call Cisco TAC 1 800 553-2447.
- 

## 2.7.173 INVMACADR

Default Severity: Major (MJ), Non-Service Affecting (NSA)

SONET Logical Object: AIP

The Equipment Failure Invalid MAC Address alarm occurs when the ONS 15454 MAC address is invalid. Each ONS 15454 has a unique, permanently assigned MAC address. The address resides on an AIP EEPROM. The TCC2/TCC2P reads the address value from the AIP chip during boot-up and keeps this value in its synchronous dynamic RAM (SDRAM).

Under normal circumstances, the read-only MAC address can be viewed in the Provisioning/Network tab in CTC.

The ONS 15454 uses both IP and MAC addresses for circuit routing. When an INVMACADR alarm exists on a node, you see a PARTIAL circuit in the CTC circuit status column. The circuit works and is able to carry traffic, but CTC cannot logically display the circuit end-to-end information.

An invalid MAC address can be caused when:

- There is a read error from the AIP during bootup; in this case, the reading TCC2/TCC2P uses the default MAC address (00-10-cf-ff-ff-ff).
- There is a read error occurring on one of the redundant TCC2/TCC2Ps that read the address from the AIP; these cards read the address independently and could therefore each read different address values.
- An AIP component failure causes a read error.

- The ribbon cable connecting the AIP card to the backplane is bad.

## Clear the INVMACADR Alarm

- 
- Step 1** Check for any outstanding alarms that were raised against the active and standby TCC2/TCC2P and resolve them.
- Step 2** If the alarm does not clear, determine whether the LCD display on the fan tray ([Figure 2-2 on page 2-126](#)) is blank or if the text is garbled. If so, proceed to [Step 8](#). If not, continue with [Step 3](#).
- Step 3** At the earliest maintenance window, reset the standby TCC2/TCC2P:



**Note** The reset requires approximately five minutes. Do not perform any other step until the reset is complete.

- Log into a node on the network. If you are already logged in, continue with [Step b](#).
- Identify the active TCC2/TCC2P.  
A green ACT/SBY LED indicates an active card. An amber ACT/SBY LED indicates a standby card.
- Right-click the standby TCC2/TCC2P in CTC.
- Choose **Reset Card** from the shortcut menu.
- Click **Yes** in the Are You Sure dialog box.  
The card resets, the FAIL LED blinks on the physical card, and connection to the node is lost. CTC switches to network view.
- Verify that the reset is complete and error-free, and that no new related alarms appear in CTC. A green ACT/SBY LED indicates an active card. An amber ACT/SBY LED indicates a standby card.
- Double-click the node and ensure that the reset TCC2/TCC2P is still in standby mode and that the other TCC2/TCC2P is active.  
A green ACT/SBY LED indicates an active card. An amber ACT/SBY LED indicates a standby card.
- Ensure that no new alarms associated with this reset appear in the CTC Alarms window.

If the standby TCC2/TCC2P fails to boot into standby mode and reloads continuously, the AIP is probably defective. In this case, the standby TCC2/TCC2P is unsuccessfully attempting to read the EEPROM located on the AIP. The TCC2/TCC2P reloads until it reads the EEPROM. Proceed to [Step 8](#).

- Step 4** If the standby TCC2/TCC2P rebooted successfully into standby mode, complete the [“Remove and Reinsert \(Reseat\) the Standby TCC2/TCC2P Card” procedure on page 2-273](#).  
Resetting the active TCC2/TCC2P causes the standby TCC2/TCC2P to become active. The standby TCC2/TCC2P keeps a copy of the chassis MAC address. If its stored MAC address is valid, the alarm should clear.
- Step 5** After the reset, note whether or not the INVMACADR alarm has cleared or is still present.
- Step 6** Complete the [“Reset an Active TCC2/TCC2P Card and Activate the Standby Card” procedure on page 2-271](#) again to place the standby TCC2/TCC2P back into active mode.  
After the reset, note whether or not the INVMACADR alarm has cleared or is still present. If the INVMACADR alarm remains standing through both TCC2/TCC2P resets, this indicates that the AIP is probably defective. Proceed to [Step 8](#).  
If the INVMACADR was raised during one TCC2/TCC2P reset and cleared during the other, the TCC2/TCC2P that was active while the alarm was raised needs to be replaced. Continue with [Step 7](#).

- Step 7** If the faulty TCC2/TCC2P is currently in standby mode, complete the “[Physically Replace a Traffic Card](#)” procedure on page 2-274 for this card. If the faulty TCC2/TCC2P is currently active, during the next available maintenance window complete the “[Reset an Active TCC2/TCC2P Card and Activate the Standby Card](#)” procedure on page 2-271 and then complete the “[Physically Replace a Traffic Card](#)” procedure on page 2-274.



---

**Note** If the replacement TCC2/TCC2P is loaded with a different software version from the current TCC2/TCC2P, the card bootup could take up to 30 minutes. During this time, the card LEDs flicker between Fail and Act/Sby as the active TCC2/TCC2P version software is copied to the new standby card.

---

- Step 8** Open a case with Cisco TAC (1 800 553-2447) for assistance with determining the node’s previous MAC address.
- Step 9** Replace the ribbon cable between the system board and the AIP with a known-good cable.
- Step 10** If the alarm persists, complete the “[Replace the Alarm Interface Panel](#)” procedure on page 2-282.
- Step 11** If the alarm does not clear, log into the Technical Support Website at <http://www.cisco.com/techsupport> for more information or call Cisco TAC 1 800 553-2447.
- 

## 2.7.174 IOSCFGCOPY

Default Severity: Not Alarmed (NA), Non-Service-Affecting (NSA)

SONET Logical Object: EQPT

The IOS Configuration Copy in Progress condition occurs on ML-Series Ethernet cards when a Cisco IOS startup configuration file is being uploaded or downloaded to or from an ML-Series card. (This condition is very similar to the “[SFTWDOWN](#)” condition on page 2-225 but it applies to ML-Series Ethernet cards rather than to the TCC2/TCC2P.)

The condition clears after the copy operation is complete. (If it does not complete correctly, the “[NO-CONFIG](#)” condition on page 2-188 could be raised.)



---

**Note** IOSCFGCOPY is an informational condition.

---



---

**Note** For more information about the ML-Series Ethernet cards, refer to the *Cisco ONS 15454 and Cisco ONS 15454 SDH Ethernet Card Software Feature and Configuration Guide*.

---

## 2.7.175 ISIS-ADJ-FAIL

Default Severity: Minor (MN), Non-Service-Affecting (NSA)

SONET Logical Object: OCN

The Open System Interconnection (OSI) Intermediate System to Intermediate-System (IS-IS) Adjacency Failure alarm is raised by an intermediate system (node routing IS Level 1 or Level 1 and 2) when no IS or end system (ES) adjacency is established on a point-to-point subnet. The Intermediate-System Adjacency Failure alarm is not supported by ES. It is also not raised by IS for disabled routers.

The alarm is typically caused by a misconfigured router manual area adjacency (MAA) address. For more information about IS-IS OSI routing and MAA configuration, refer to the “Management Network Connectivity” chapter in the *Cisco ONS 15454 Reference Manual*. For more information about configuring OSI, refer to the “Turn Up Node” chapter in the *Cisco ONS 15454 Procedure Guide*.

## Clear the ISIS-ADJ-FAIL Alarm

- 
- Step 1** Ensure that both ends of the communication channel are using the correct Layer 2 protocol and settings (LAPD or PPP). To do this, complete the following steps:
- At the local node, in node view, click the **Provisioning > Comm Channels > SDCC** tabs.
  - Click the row of the circuit. Click **Edit**.
  - In the Edit SDCC termination dialog box, view and record the following selections: Layer 2 protocol (LAPD or PPP); Mode radio button selection (AITS or UITS); Role radio button selection (Network or User); MTU value; T200 value, and T203 selections.
  - Click **Cancel**.
  - Login to the remote node and follow the same steps, also recording the same information for this node.
- Step 2** If both nodes do not use the same Layer 2 settings, you will have to delete the incorrect termination and recreate it. To delete it, click the termination and click **Delete**. To recreate it, refer to the “Turn Up Node” chapter in the *Cisco ONS 15454 Procedure Guide* for the procedure.
- Step 3** If the nodes use PPP Layer 2, complete the “[Clear the EOC Alarm](#)” procedure on page 2-83. If the alarm does not clear, go to [Step 7](#).
- Step 4** If both nodes use the LAPD Layer 2 protocol but have different Mode settings, change the incorrect node’s entry by clicking the correct setting radio button in the Edit SDCC termination dialog box and clicking **OK**.
- Step 5** If the Layer 2 protocol and Mode settings are correct, ensure that one node is using the Network role and the other has the User role. If not (that is, if both have the same mode settings), correct the incorrect one by clicking the correct radio button in the Edit SDCC termination dialog box and clicking **OK**.
- Step 6** If the Layer 2, Mode, and Role settings are correct, compare the MTU settings for each node. If one is incorrect, choose the correct value in the Edit SDCC dialog box and click **OK**.
- Step 7** If all of the preceding settings are correct, ensure that OSI routers are enabled for the communications channels at both ends:
- Click **Provisioning > OSI > Routers > Setup** tabs.
  - View the router entry under the **Status** column. If the status is Enabled, check the other end.
  - If the Status is Disabled, click the router entry and click **Edit**.
  - Check the **Enabled** check box and click **OK**.
- Step 8** If the routers on both ends are enabled and the alarm still has not cleared, ensure that both ends of the communications channel have a common MAA:
- Click the **Provisioning > OSI > Routers > Setup** tabs.
  - Record the primary MAA and secondary MAAs, if configured.



### Tip

You can record long strings of information such as the MAA address by using the CTC export and print functions. Export it by choosing File > Export > html. Print it by choosing File > Print.

- c. Log into the other node and record the primary MAA and secondary MAAs, if configured.
- d. Compare this information. There should be at least one common primary or secondary MAA in order to establish an adjacency.
- e. If there is no common MAA, one must be added to establish an adjacency. Refer to the “Turn Up Node” chapter in the *Cisco ONS 15454 Procedure Guide* for procedures.

**Step 9** If the alarm does not clear, log into the Technical Support Website at <http://www.cisco.com/techsupport> for more information or call Cisco TAC 1 800 553-2447.

---

## 2.7.176 KB-PASSTHR

Default Severity: Not Alarmed (NA), Non-Service-Affecting (NSA)

SONET Logical Object: OCN

The K Bytes Pass Through Active condition occurs on a nonswitching node in a BLSR when the protect channels on the node are not active and the node is in K Byte pass-through state. It also occurs when a BLSR ring is being exercised using the Exercise Ring command.

### Clear the KB-PASSTHR Condition

---

**Step 1** Complete the “[Clear a BLSR External Switching Command](#)” procedure on page 2-270.

**Step 2** If the condition does not clear, log into the Technical Support Website at <http://www.cisco.com/techsupport> for more information or call Cisco TAC 1 800 553-2447.

---

## 2.7.177 KBYTE-APS-CHAN-FAIL

Default Severity: Minor (MN), Non-Service Affecting (NSA)

SONET Logical Object: OCN

The APS Channel Failure alarm is raised when a span is provisioned for different APS channels on each side. For example, the alarm is raised if K3 is selected on one end and F1, E2, or Z2 is selected on the other end.

This alarm is also raised during checksum failure if the K1 and K2 bytes are overwritten by test equipment. It is not raised in bidirectional full pass-through or K-byte pass-through states. The alarm is overridden by the “[AIS-P](#)” alarm on page 2-38, the “[LOF \(OCN\)](#)” alarm on page 2-152, the “[LOS \(OCN\)](#)” alarm on page 2-165 or the “[SF-P](#)” alarm on page 2-225.

### Clear the KBYTE-APS-CHAN-FAIL Alarm

---

**Step 1** The alarm is most frequently raised due to mismatched span provisioning. In this case, reprovision one side of the span with the same parameters. To do this, refer to the “Turn Up Network” chapter in the *Cisco ONS 15454 Procedure Guide*.

- Step 2** If the error is not caused by misprovisioning, it is due to checksum errors within an OC-N, cross-connect, or TCC2/TCC2P. In this case, complete the “[Side Switch the Active and Standby Cross-Connect Cards](#)” procedure on page 2-272 to allow CTC to resolve the issue.
- Step 3** If third-party equipment is involved, ensure that it is configured for the same APS channel as the Cisco ONS equipment.
- Step 4** If the alarm does not clear, log into the Technical Support Website at <http://www.cisco.com/techsupport> for more information or call Cisco TAC 1 800 553-2447.
- 

## 2.7.178 LAN-POL-REV

Default Severity: Not Alarmed (NA), Non-Service-Affecting (NSA)

SONET Logical Object: NE

The LAN Connection Polarity Reversed condition is not raised in shelves that contain TCC2 cards. It is raised during a software upgrade when the card detects that a connected Ethernet cable has reversed receive wire pairs. The card automatically compensates for this reversal, but LAN-POL-REV stays active.



**Note**

For more information about Ethernet cards, refer to the *Cisco ONS 15454 and Cisco ONS 15454 SDH Ethernet Card Software Feature and Configuration Guide*.

---

### Clear the LAN-POL-REV Condition

- Step 1** Replace the connected Ethernet cable with a cable that has the correct pinout. For correct pin mapping, refer to the “Maintain the Node” chapter in the *Cisco ONS 15454 Procedure Guide*.
- Step 2** If the alarm does not clear, log into the Technical Support Website at <http://www.cisco.com/techsupport> for more information or call Cisco TAC 1 800 553-2447.
- 

## 2.7.179 LASER-APR

For information about this alarm or condition, refer to the “Alarm Troubleshooting” chapter in the *Cisco ONS 15454 DWDM Troubleshooting Guide*. This guide discusses all DWDM alarms.

## 2.7.180 LASERBIAS-DEG

For information about this alarm or condition, refer to the “Alarm Troubleshooting” chapter in the *Cisco ONS 15454 DWDM Troubleshooting Guide*. This guide discusses all DWDM alarms.

## 2.7.181 LASERBIAS-FAIL

For information about this alarm or condition, refer to the “Alarm Troubleshooting” chapter in the *Cisco ONS 15454 DWDM Troubleshooting Guide*. This guide discusses all DWDM alarms.

## 2.7.182 LASEREOL

Default Severity: Minor (MN), Non-Service-Affecting (NSA)

SONET Logical Object: OCN

The Laser Approaching End of Life alarm applies to TXP\_MR\_10G, TXP\_MR\_2.5G, TXPP\_MR\_2.5G, TXP\_MR\_10E, and MXP\_2.5G\_10G cards. It is typically accompanied by the “[HI-LASERBIAS](#)” alarm on page 2-123. It is an indicator that the laser in the card must be replaced. How soon the replacement must happen depends upon the HI-LASERBIAS alarm’s threshold. If the threshold is set under 100 percent, the laser replacement can usually be done during a maintenance window. But if the HI-LASERBIAS threshold is set at 100 percent and is accompanied by data errors, LASEREOL indicates the card must be replaced sooner.



**Note**

For more information about MXP or TXP cards, refer to the *Cisco ONS 15454 DWDM Reference Manual*.

### Clear the LASEREOL Alarm

- 
- Step 1** Complete the “[Physically Replace a Traffic Card](#)” procedure on page 2-274.
  - Step 2** If the alarm does not clear, log into the Technical Support Website at <http://www.cisco.com/techsupport> for more information or call Cisco TAC 1 800 553-2447.
- 

## 2.7.183 LASERTEMP-DEG

For information about this alarm or condition, refer to the “Alarm Troubleshooting” chapter in the *Cisco ONS 15454 DWDM Troubleshooting Guide*. This guide discusses all DWDM alarms.

## 2.7.184 LCAS-CRC

Default Severity: Not Alarmed (NA), Non-Service-Affecting (NSA)

SONET Logical Objects: STSTRM, VT-TERM

The Link Capacity Adjustment Scheme (LCAS) Control Word CRC Failure condition is raised against ML-Series Ethernet cards and CE-series cards. It occurs when there is an equipment, path, or provisioning error on the virtual concatenation group (VCG) that causes consecutive 2.5 second CRC failures in the LCAS control word.

Transmission errors would be reflected in CV-P, ES-P, or SES-P performance monitoring statistics. If these errors do not exist, an equipment failure is indicated.

If LCAS is not supported on the peer node, the condition does not clear.



LCAS-CRC can also occur if the VCG source node is not LCAS-enabled, but the receiving node does have the capability enabled. Both source and destination nodes must have LCAS enabled. Otherwise, the LCAS-CRC condition persists on the VCG.

**Note**

For more information about the ML-Series Ethernet cards, refer to the *Cisco ONS 15454 and Cisco ONS 15454 SDH Ethernet Card Software Feature and Configuration Guide*.

## Clear the LCAS-CRC Condition

- 
- Step 1** Look for and clear any associated equipment failures, such as the EQPT alarm, on the receive node or transmit node.
- Step 2** Look for and clear any bit error rate alarms at the transmit node.
- Step 3** If no equipment or SONET path errors exist, ensure that the remote node has LCAS enabled on the circuit:
- In node view, click the **Circuits** tab.
  - Choose the VCAT circuit and click **Edit**.
  - In the Edit Circuit window, click the **General** tab.
  - Verify that the Mode column says **LCAS**.
- Step 4** If the column does not say LCAS, complete the [“Delete a Circuit” procedure on page 2-276](#) and recreate it in LCAS mode using the instructions in the *Cisco ONS 15454 and Cisco ONS 15454 SDH Ethernet Card Software Feature and Configuration Guide*.
- Step 5** If the condition does not clear, log into the Technical Support Website at <http://www.cisco.com/techsupport> for more information or call Cisco TAC 1 800 553-2447.
- 

## 2.7.185 LCAS-RX-DNU

Default Severity: Major (MJ), Service-Affecting (SA)

SONET Logical Objects: STSTRM, VT-TERM

The LCAS VCG Member Receive-Side-In Do Not Use condition is raised on CE-MR-10 cards and ML-MR-10 Ethernet cards when the receive side of an LCAS VCG member is in the do-not use state. For a unidirectional failure, this condition is only raised at the source node.

The node reporting this condition likely reports an [“RFI-P” alarm on page 2-205](#) and [“RFI-V” alarm on page 2-206](#) for CE-MR-10, and [“RFI-P” alarm on page 2-205](#) for ML-MR-10.

**Note**

For more information about the CE-MR-10 and ML-MR-10 Ethernet cards, refer to the *Cisco ONS 15454 and Cisco ONS 15454 SDH Ethernet Card Software Feature and Configuration Guide*.

## Clear the LCAS-RX-DNU Condition

- 
- Step 1** Look for any SONET failures, such as the RFI-P and RFI-V alarms, on the source node. If any are present, clear them using the relevant procedures in this chapter.
- Step 2** If the condition does not clear, log into the Technical Support Website at <http://www.cisco.com/techsupport> for more information or call Cisco TAC 1 800 553-2447.
- 

## 2.7.186 LCAS-RX-FAIL

Default Severity: Not Alarmed (NA), Non-Service-Affecting (NSA)

SONET Logical Objects: STSTRM, VT-TERM

The LCAS VCG Member Receive-Side-In Fail condition is raised against CE-series cards, FC\_MR-4 cards and ML-Series Ethernet cards with LCAS-enabled VCG.

LCAS VCGs treat failures unidirectionally, meaning that failures of the transmit or receive points occur independently of each other. The LCAS-RX-FAIL condition can occur on the receive side of an LCAS VCG member for the following reasons:

- SONET path failure (a unidirectional failure as seen by the receive side)
- VCAT member is set out of group at the transmit side, but is set in group at the receive side
- VCAT member does not exist at the transmit side but does exist and is in group at the receive side

The condition can be raised during provisioning operations on LCAS VCGs but should clear when the provisioning is completed.

Software-enabled LCAS VCGs treat failure bidirectionally, meaning that both directions of a VCG member are considered failed if either transmit or receive fails. The LCAS-RX-FAIL condition is raised on these VCG members when a member receive side fails due to a SONET path failure.



**Note**

For more information about the ML-Series Ethernet cards, refer to the *Cisco ONS 15454 and Cisco ONS 15454 SDH Ethernet Card Software Feature and Configuration Guide*.



**Note**

ML-Series cards are LCAS-enabled. ML-Series and FC\_MR-4 cards are SW-LCAS enabled.

## Clear the LCAS-RX-FAIL Condition

- 
- Step 1** Check for and clear any line or path alarms (typically ending in “-L” or “-P”).
- Step 2** If the condition does not clear, log into the Technical Support Website at <http://www.cisco.com/techsupport> for more information or call Cisco TAC 1 800 553-2447.
-

## 2.7.187 LCAS-RX-GRP-ERR

Default Severity: Major (MJ), Service-Affecting (SA)

SONET Logical Objects: STSTRM, VT-TERM

The LCAS Sink Group Error condition is raised against ML-MR-10 and CE-MR-10 Ethernet cards. This condition is raised if the LCAS member sink has a group error.

### Clear the LCAS-RX-GRP-ERR Condition

- 
- Step 1** Clear any LCAS member sink group errors.
- Step 2** If the condition does not clear, log into the Technical Support Website at <http://www.cisco.com/techsupport> for more information or call Cisco TAC 1 800 553-2447.
- 

## 2.7.188 LCAS-TX-ADD

Default Severity: Not Alarmed (NA), Non-Service-Affecting (NSA)

SONET Logical Objects: STSTRM, VT-TERM

The LCAS VCG Member Transmit-Side-In Add State condition is raised against ML-Series Ethernet and CE-series cards when the transmit side of an LCAS VCG member is in the add state. The condition clears after provisioning is completed. The remote likely reports a path condition such as the “AIS-P” condition on page 2-38 or the “UNEQ-P” alarm on page 2-253



---

**Note** LCAS-TX-ADD is an informational condition and does not require troubleshooting.

---



---

**Note** For more information about the ML-Series Ethernet cards, refer to the *Cisco ONS 15454 and Cisco ONS 15454 SDH Ethernet Card Software Feature and Configuration Guide*.

---

## 2.7.189 LCAS-TX-DNU

Default Severity: Not Alarmed (NA), Non-Service-Affecting (NSA)

SONET Logical Objects: STSTRM, VT-TERM

The LCAS VCG Member Transmit-Side-In Do Not Use condition is raised on FC\_MR-4 cards, ML-Series Ethernet cards, and CE-series cards when the transmit side of an LCAS VCG member is in the do-not use state. For a unidirectional failure, this condition is only raised at the source node. The LCAS-TX-DNU condition is raised when the cable is unplugged.

The node reporting this condition likely reports an “RFI-P” alarm on page 2-205, and the remote node likely reports a path alarm such as the “AIS-P” alarm on page 2-38 or the “UNEQ-P” alarm on page 2-253.



---

**Note** LCAS-TX-DNU is an informational condition and does not require troubleshooting.

---

**Note**

For more information about the ML-Series Ethernet cards, refer to the *Cisco ONS 15454 and Cisco ONS 15454 SDH Ethernet Card Software Feature and Configuration Guide*.

## 2.7.190 LINK-KEEPALIVE

Default Severity: Critical (CR), Non-Service-Affecting (NSA)

SONET Logical Objects: ML1000, ML100T, MLFX, OCN

The LINK-KEEPALIVE alarm indicates that a span is not receiving a defined number of keep-alive messages on the ML card's IEEE 802.17b-based interface or Cisco proprietary RPR interface within allotted keep-alive timeout period. Although this alarm defaults to a Critical (CR) severity, it can be downgraded if the span is protected.

A LINK-KEEPALIVE alarm causes the “RPR-SF” alarm on page 2-215 to be raised also. LINK-KEEPALIVE is suppressed by the “RPR-PASSTHR” alarm on page 2-210. This alarm clears when a defined number of consecutive keep-alive messages is received on the interface.

**Note**

In the Cisco IOS CLI “show ons alarms” command display, this alarm is called KEEP-ALIVE-FAIL.

**Note**

The GFP-UP-MISMATCH, GFP-CSF, GFP-LFD, and TPTFAIL alarms suppress the LINK-KEEPALIVE alarm even though the LINK-KEEPALIVE alarm has higher severity than the other alarms. The GFP alarms are promoted because the LINK-KEEPALIVE alarm information is contained within a GFP frame. The TPTFAIL alarm is promoted because it is a layer 1 alarm while LINK-KEEPALIVE is a layer 2 alarm.

### Clear the LINK-KEEPALIVE Alarm

- Step 1** Verify that no SONET or GFP circuit alarms that could impact Ethernet data traffic are present. If any are present, clear them using the relevant procedures in this chapter.
- Step 2** Verify that the “DATA-CRC” alarm on page 2-76 is not present. If it is present, complete the trouble-clearing procedure.
- Step 3** Verify that the keep-alive timer on this IEEE RPR 802.17b-based station has the same value as its neighboring RPR-IEEE stations.
- Step 4** If the alarm does not clear, log into the Technical Support Website at <http://www.cisco.com/techsupport> for more information or call Cisco TAC 1 800 553-2447.

## 2.7.191 LKOUTPR-S

Default Severity: Not Alarmed (NA), Non-Service-Affecting (NSA)

SONET Logical Object: OCN

The Lockout of Protection Span condition occurs when span traffic is locked out of a protect span using the Lockout of Protect command. This condition is visible on the network view Alarms, Conditions, and History tabs after the lockout has occurred and accompanies the “FE-LOCKOUTOFPR-SPAN” alarm on page 2-109. The port where the lockout originated is marked by an “L” on the network view detailed circuit map.

## Clear the LKOUTPR-S Condition

- 
- Step 1** Complete the “[Clear a BLSR External Switching Command](#)” procedure on page 2-270.
- Step 2** If the condition does not clear, log into the Technical Support Website at <http://www.cisco.com/techsupport> for more information or call Cisco TAC 1 800 553-2447.
- 

## 2.7.192 LMP-FAIL

Default Severity: Minor (MN), Non-Service-Affecting (NSA)

SONET Logical Objects: CLIENT, CTRL, TLINK

The Link Management Protocol Fail alarm is raised by the TCC2/TCC2P card when an LMP control channel fails or when there is a traffic engineering (TE) link correlation error. When the alarm is raised against a control channel, it uses a control channel (CTRLx) AID. When the alarm is raised against a TE link, a TE link AID (TLINKx) is used.

The alarm clears when the control channel or TE link is restored.



**Note** LMP-FAIL occurs independently of the condition hierarchy between the “[LMP-SD](#)” alarm on page 2-144, the “[LMP-SF](#)” alarm on page 2-145, or the “[LMP-UNALLOC](#)” alarm on page 2-146.



**Note** When the LMP-FAIL alarm is reported against a control channel (CTRLx) AID, it only refers to control channel failure. It does not directly indicate data link or traffic engineering link status.



**Note** When the LMP-FAIL alarm is reported against a TE link AID (TLINKx), it refers only to TE link status, not to control channel or data link status.

## Clear the LMP-FAIL Alarm

- 
- Step 1** Verify the AID (CTRLx or TLINKx) of the alarm.
- Step 2** If the alarm is against the control channel AID, this is caused by mismatched control channel parameters between the near-end ONS 15454 and the far-end node (which may be another vendor’s equipment). Complete the following steps:
- a. Determine whether both near-end and far-end sides of the control channel are in the IS administrative state:

- Click the **Provisioning > Comm Channels > LMP > Control Channel** tabs and view the Admin State column content for the channel.
  - If the status does not say IS, change it and click **Apply**.
- b.** Determine whether the near-end node LMP configuration contains the far-end node's IP address as its remote node IP. Also verify that the near-end node's LMP configuration uses the LMP node ID as its own remote node ID. If one or more of these values is incorrect, enter it correctly.
- c.** Determine whether the far-end node LMP configuration contains the near-end node's IP address as its remote node IP. Also verify that the far-end node's LMP configuration uses the LMP node ID as its own remote node ID. If one or more of these values is incorrect, enter it correctly.
- d.** Verify that the far-end node is using the near-end node's IP address as its remote node IP address, and that the far end is also using the LMP node ID as its remote node ID. Update the far end's values if they are incorrect.
- Step 3** If instead the alarm is raised against the TE link AID, complete the following steps:
- a.** Determine whether both near-end and far-end sides of the TE link are in the IS administrative state. If either end is currently down, update its administrative state to IS:
- Click the **Provisioning > Comm Channels > LMP > TE link** tab.
  - If the status does not say IS, change it and click **Apply**.
- b.** Determine whether the near-end node's remote TE link ID matches the far-end node's local TE link ID. If the near-end node's remote value is incorrect, enter it correctly.
- c.** Determine whether the far-end node's remote TE link ID corresponds to the near-end node's local TE link ID. If the far-end node's remote value is incorrect, enter it correctly.
- Step 4** If the alarm does not clear, log into the Technical Support Website at <http://www.cisco.com/techsupport> for more information or call Cisco TAC 1 800 553-2447.
- 

## 2.7.193 LMP-SD

Default Severity:Not Alarmed (NA), Non-Service-Affecting (NSA)

SONET Logical Object: OCN

DWDM Logical Object: GE

The LMP Data Link Signal Degrade condition occurs for when the TCC2/TCC2P receives an LMP link summary or channel status message that the control channel is not available from the far end, so the data link level of service is not guaranteed. The degrade range is provisionable.

LMP-SD clears when the TCC2/TCC2P receives a link summary or channel status message reporting that the data link is in the Signal Okay (OK) state.

LMP-SD is part of an alarm hierarchy that includes the “LMP-SF” alarm on page 2-145 and the “LMP-UNALLOC” alarm on page 2-146. The hierarchy is as follows: If LMP-UNALLOC is raised, LMP-SF and LMP-SD are suppressed. If LMP-SF is raised, it suppresses LMP-SD. LMP-SF and LMP-UNALLOC both suppress near-end LOS-type alarms for DWDM clients. LMP-SD, however, does not suppress LOS alarms.

This condition clears when the far-end trouble has been cleared.

## Clear the LMP-SD Condition

- Step 1** Look for and clear any of the following alarms in [Table 2-13](#) and [Table 2-14](#) occurring on the far-end port. Refer to the *Cisco ONS 15454 DWDM Troubleshooting Guide, R7.x* for DWDM trunk ([Table 2-13](#)) and client ([Table 2-14](#)) alarm trouble-clearing procedures.

**Table 2-13 Transponder Trunk Alarms that Cause LMP-SD**

| Trunk Port Alarm | LMP Failure | Direction |
|------------------|-------------|-----------|
| SD               | SD          | Tx        |
| OTUK-SD          | SD          | Tx        |
| ODUK-SD-PM       | SD          | Tx        |
| ODUK-SD-TCM1     | SD          | Tx        |
| ODUK-SD-TCM2     | SD          | Tx        |

**Table 2-14 Transponder Client Alarm that Causes LMP-SD**

| Client Port Alarm | LMP Failure | Direction |
|-------------------|-------------|-----------|
| SD                | SD          | Rx        |

- Step 2** If the LMP-SD condition does not clear, log into the Technical Support Website at <http://www.cisco.com/techsupport> for more information or call Cisco TAC 1 800 553-2447.

## 2.7.194 LMP-SF

Default Severity:Not Alarmed (NA), Non-Service-Affecting (NSA)

SONET Logical Object: OCN

DWDM Logical Object: GE

The LMP Data Link Signal Fail condition notifies the near-end user of a far-end problem (and thus is NSA for the near end). The near-end's TCC2/TCC2P receives an LMP link summary or channel status message that the data link service has failed. The signal fail threshold is provisionable.

LMP-SF clears when the TCC2/TCC2P receives a link summary or channel status message reporting that the data link is in the Signal Okay (OK) state.

LMP-SF is part of an alarm hierarchy that includes the “[LMP-SD](#)” alarm on page 2-144 and the “[LMP-UNALLOC](#)” alarm on page 2-146. The hierarchy is as follows: If LMP-UNALLOC is raised, LMP-SF and LMP-SD are suppressed. If LMP-SF is raised, it suppresses LMP-SD. LMP-SF and LMP-UNALLOC both suppress near-end LOS-type alarms for DWDM clients, but LMP-SD does not suppress LOS-type alarms.

This condition clears when the far-end trouble has been cleared.

## Clear the LMP-SF Condition

- Step 1** Look for and clear any of the following alarms in [Table 2-15](#), [Table 2-16](#), or [Table 2-17](#) occurring on the far-end port. The card alarms are located in this chapter. The *Cisco ONS 15454 DWDM Troubleshooting Guide, R7.x* contains trouble-clearing procedures for DWDM trunk ([Table 2-16](#)) and client ([Table 2-17](#)) alarms.

**Table 2-15** *Transponder Card Alarms that Cause LMP-SF*

| Card Alarm                           | LMP Failure | Direction |
|--------------------------------------|-------------|-----------|
| <a href="#">EQPT, page 86</a>        | SF          | Tx        |
| <a href="#">IMPROPRMVL, page 128</a> | SF          | Tx        |

**Table 2-16** *Transponder Trunk Alarms that Cause LMP-SF*

| Trunk Port Alarm | LMP Failure | Direction |
|------------------|-------------|-----------|
| LOS              | SF          | Tx        |
| OTUK-LOF         | SF          | Tx        |
| OTUK-AIS         | SF          | Tx        |
| LOM              | SF          | Tx        |
| OTUK-SF          | SF          | Tx        |
| ODUK-SF-PM       | SF          | Tx        |
| ODUK-SF-TCM1     | SF          | Tx        |
| ODUK-SF-TCM2 SF  | SF          | Tx        |
| FEC-MISM         | SF          | Tx        |

**Table 2-17** *Transponder Client Alarms that Cause LMP-SF*

| Client Alarm | LMP Failure | Direction |
|--------------|-------------|-----------|
| LOS          | SF          | Rx        |
| SIGLOSS      | SF          | Rx        |
| SYNCLOSS     | SF          | Rx        |
| CARLOSS      | SF          | Rx        |
| LOF          | SF          | Rx        |

- Step 2** If the condition does not clear, log into the Technical Support Website at <http://www.cisco.com/techsupport> for more information or call Cisco TAC 1 800 553-2447.

## 2.7.195 LMP-UNALLOC

Default Severity:Not Alarmed (NA), Non-Service-Affecting (NSA)



SONET Logical Object: OCN

DWDM Logical Object: GE

The LMP Data Link Unallocated condition is raised when the TCC2/TCC2P receives an LMP link summary or channel status message reporting that the data link is unallocated for data traffic. The condition clears when the data link is allocated and sends an LMP link summary or channel status message to this effect. If a data link has the LMP-UNALLOC alarm raised against it, this should suppress all other alarms on the client port, since the far-end node is not using the errored port. (Consequently you do not have to clear any alarms on the far-end node's unused port.)

LMP-UNALLOC is part of an alarm hierarchy that includes the “LMP-SD” alarm on page 2-144 and the “LMP-SF” alarm on page 2-145. The hierarchy is as follows: If LMP-UNALLOC is raised, LMP-SF and LMP-SD are suppressed. If LMP-SF is raised, it suppresses LMP-SD. LMP-SF and LMP-UNALLOC both suppress near-end LOS-type DWDM client alarms, but LMP-SD does not.

In most cases, this condition is an informational notice at the near-end node that the far-end port is not being utilized. If, however, the far-end port should be allocated for traffic, log into the Technical Support Website at <http://www.cisco.com/techsupport> for more information or call Cisco TAC 1 800 553-2447.

## 2.7.196 LOA

Default Severity: Critical (CR), Service-Affecting (SA)

SONET Logical Object: VCG

The Loss of Alignment on a VCG is a VCAT member alarm. (VCAT member circuits are independent circuits that are concatenated from different time slots into a higher-rate signal.) The alarm occurs when members of a VCG travel over different paths in the network (due to initial operator provisioning or to protection or restoration events) and the differential delays between the paths cannot be recovered by terminating hardware buffers.

### Clear the LOA Alarm

- 
- Step 1** In network view, click the **Circuits** tab.
  - Step 2** Click the alarmed VCG and then click **Edit**.
  - Step 3** In the Edit Circuit window, view the source and destination circuit slots, ports, and STSs.
  - Step 4** Identify whether the STS travels across different fibers. If it does, complete the “[Delete a Circuit](#)” procedure on page 2-276.
  - Step 5** Recreate the circuit using the procedure in the “Create Circuits and VT Tunnels” chapter in the *Cisco ONS 15454 Procedure Guide*.
  - Step 6** If the alarm does not clear, log into the Technical Support Website at <http://www.cisco.com/techsupport> for more information or call Cisco TAC 1 800 553-2447 in order to report a Service-Affecting (SA) problem.
- 

## 2.7.197 LOCKOUT-REQ

Default Severity: Not Alarmed (NA), Non-Service-Affecting (NSA)

SONET Logical Objects: EQPT, OCN, STSMON, VT-MON

DWDM Logical Objects: 2R, ESCON, FC, GE, ISC, TRUNK

The Lockout Switch Request on Facility or Equipment condition occurs when a user initiates a lockout switch request for an OC-N port in a 1+1 facility protection group. This can be accomplished by locking traffic onto the working port with the LOCK ON command (thus locking it off the protect port), or locking it off the protect port with the LOCK OUT command. In either case, the protect port will show “Lockout of Protection,” and the Conditions window will show the LOCKOUT-REQ condition.

A lockout prevents protection switching. Clearing the lockout again allows protection switching and clears the LOCKOUT-REQ condition.

## Clear the LOCKOUT-REQ Condition

- 
- Step 1** Complete the “[Clear a Lock-On or Lockout Command](#)” procedure on page 2-265.
- Step 2** If the condition does not clear, log into the Technical Support Website at <http://www.cisco.com/techsupport> for more information or call Cisco TAC 1 800 553-2447.
- 

## 2.7.198 LOF (BITS)

Default Severity: Minor (MN), Non-Service-Affecting (NSA)

SONET Logical Object: BITS

The Loss of Frame (LOF) BITS alarm occurs when a port on the TCC2/TCC2P BITS input detects an LOF on the incoming BITS timing reference signal. LOF indicates that the receiving ONS 15454 has lost frame delineation in the incoming data.



### Note

The procedure assumes that the BITS timing reference signal is functioning properly. It also assumes the alarm is not appearing during node turn-up.

---

## Clear the LOF (BITS) Alarm

- 
- Step 1** Verify that the line framing and line coding match between the BITS input and the TCC2/TCC2P:
- a. In node or card view, note the slot and port reporting the alarm.
  - b. Find the coding and framing formats of the external BITS timing source. The formats should be in the user documentation for the external BITS timing source or on the timing source itself.
  - c. Click the **Provisioning > Timing > BITS Facilities** tabs.
  - d. Verify that the Coding setting matches the coding of the BITS timing source, either B8ZS or AMI.
  - e. If the coding does not match, click **Coding** and choose the appropriate coding from the drop-down list.
  - f. Verify that Framing matches the framing of the BITS timing source, either ESF or SF (D4).
  - g. If the framing does not match, click **Framing** and choose the appropriate framing from the drop-down list.

**Note**

---

On the timing subtab, the B8ZS coding field is normally paired with ESF in the Framing field and the AMI coding field is normally paired with SF (D4) in the Framing field.

---

- Step 2** If the alarm does not clear when the line framing and line coding match between the BITS input and the TCC2/TCC2P, complete the [“Physically Replace a Traffic Card” procedure on page 2-274](#) for the TCC2/TCC2P.
- Step 3** If the alarm does not clear, log into the Technical Support Website at <http://www.cisco.com/techsupport> for more information or call Cisco TAC 1 800 553-2447 in order to report a Service-Affecting (SA) problem.
- 

## 2.7.199 LOF (DS1)

Default Severity: Major (MJ), Service-Affecting (SA)

SONET Logical Object: DS1

The DS-1 LOF alarm indicates that the receiving ONS 15454 has lost frame delineation in an incoming DS-1 data stream.

### Clear the LOF (DS1) Alarm

- Step 1** Verify that the line framing and line coding match between the DS1 port and the signal source:
- In CTC, note the slot and port reporting the alarm.
  - Find the coding and framing formats of the signal source for the card reporting the alarm. You could need to contact your network administrator for the format information.
  - Display the card view of the reporting card.
  - Click the **Provisioning > Line** tabs.
  - Verify that the line type of the reporting port matches the line type of the signal source (DS4 and DS4, unframed and unframed, or ESF and ESF). If the signal source line type does not match the reporting port, click the **Line Type** cell to reveal a drop-down list and choose the matching type.
  - Verify that the reporting Line Coding matches the signal source line coding (AMI and AMI or B8ZS and B8ZS). If the signal source line coding does not match the reporting port, click the **Line Coding** cell and choose the correct type from the drop-down list.
  - Click **Apply**.

**Note**

---

On the Line tab, the B8ZS coding field is normally paired with ESF in the Framing field. AMI coding is normally paired with SF (D4) in the Framing field.

---

**Note**

---

When you replace a card with the identical type of card, you do not need to make any changes to the database.

---

- Step 2** If the alarm does not clear, log into the Technical Support Website at <http://www.cisco.com/techsupport> for more information or call Cisco TAC 1 800 553-2447 in order to report a Service-Affecting (SA) problem.
- 

## 2.7.200 LOF (DS3)

Default Severity: Critical (CR), Service-Affecting (SA)

SONET Logical Object: DS3

The DS-3 LOF alarm indicates that the receiving ONS 15454 has lost frame delineation in the incoming DS-3 data stream on DS3XM-6, DS3XM-12, or add DS3/EC1-48 cards. The framing of the transmitting equipment could be set to a format that differs from the receiving system. On DS3XM cards, the alarm occurs only on cards with the provisionable framing format set to C Bit or M13 and not on cards with the provisionable framing format is set to unframed.

### Clear the LOF (DS3) Alarm

- Step 1** Change the line type of the non-ONS equipment attached to the reporting card to C Bit:
- a. Display the card view of the reporting card.
  - b. Click the **Provisioning > Line** tabs.
  - c. Verify that the line type of the reporting port matches the line type of the signal source.
  - d. If the signal source line type does not match the reporting port, click **Line Type** and choose **C Bit** from the drop-down list.
  - e. Click **Apply**.
- Step 2** If the alarm does not clear, log into the Technical Support Website at <http://www.cisco.com/techsupport> for more information or call Cisco TAC 1 800 553-2447 in order to report a Service-Affecting (SA) problem.
- 

## 2.7.201 LOF (E1)

Default Severity: Major (MJ), Service-Affecting (SA)

SONET Logical Object: E1

The E1 LOF alarm appears on the DS1/E1-56 card when the card is placed in All E1 mode. It indicates that the receiving ONS 15454 has lost frame delineation in an incoming E1 data stream. The transmitting equipment could possibly have its framing set to a format that differs from the receiving node. For more information about the DS1/E1-56 card, refer to the “Electrical Cards” chapter in the *Cisco ONS 15454 Reference Manual*.



**Note**

The DS1/E1-56 card only carries an E1 signal within an STS-3c/VT2 circuit.

---

## Clear the LOF (E1) Alarm

- Step 1** Verify that the line framing and line coding match between the DS1/E1-56 port and the signal source:
- In CTC, note the slot and port reporting the alarm.
  - Find the coding and framing formats of the signal source for the card reporting the alarm. You could need to contact your network administrator for this information.
  - Double-click the DS1/E1-56 card to open the card view.
  - Click the **Provisioning > Line** tabs.
  - Verify that the line type of the reporting port matches the line type (E1\_MF, E1\_CRCMF, AUTOFRAMED, UNFRAMED) of the signal source. If the signal source line type does not match the reporting port, click the **Line Type** cell to reveal a drop-down list and choose the matching type.
  - Verify that the reporting Line Coding matches the signal source line coding. If the signal source line coding does not match the reporting port, click the **Line Coding** cell and choose the correct type from the drop-down list.
  - Click **Apply**.



**Note** When you replace a card with the identical type of card, you do not need to make any changes to the database.

- Step 2** If the alarm does not clear, log into the Technical Support Website at <http://www.cisco.com/techsupport> for more information or call Cisco TAC 1 800 553-2447 in order to report a Service-Affecting (SA) problem.

## 2.7.202 LOF (EC1)

Default Severity: Critical (CR), Service-Affecting (SA)

SONET Logical Object: EC1

The EC1/EC1-12 LOF alarm occurs when a port on the reporting EC1/EC1-12 or DS3/EC1-48 card has an LOF condition. LOF indicates that the receiving ONS 15454 has lost frame delineation in the incoming data. LOF occurs when the SONET overhead loses a valid framing pattern for 3 milliseconds. Receiving two consecutive valid A1/A2 framing patterns clears the alarm.

## Clear the LOF (EC1) Alarm

- Step 1** Verify cabling continuity to the port reporting the alarm. To verify cable continuity, follow site practices.



**Caution** Always use the supplied electrostatic discharge wristband when working with a powered ONS 15454. Plug the wristband cable into the ESD jack located on the lower-right edge of the shelf assembly.

- Step 2** If cabling continuity is good, clean the fiber according to site practice. If no site practice exists, complete the procedure in the “Maintain the Node” chapter in the *Cisco ONS 15454 Procedure Guide*.

- Step 3** If the alarm does not clear, see the loopback procedures in [Chapter 1, “General Troubleshooting”](#) to isolate the fault causing the LOF alarm.
- Step 4** If the alarm does not clear, or if you need assistance conducting network troubleshooting tests, call Cisco TAC to report a Service-Affecting (SA) problem 1 800 553-2447.

## 2.7.203 LOF (OCN)

Default Severity: Critical (CR), Service-Affecting (SA)

SONET Logical Object: OCN

The LOF alarm occurs when a port on the reporting card has an LOF condition. It can also occur on ONS 15454 MXP\_2.5G\_10G, TXP\_MR\_10G, TXP\_MR\_2.5G, TXP\_MR\_10E, or TXPP\_MR\_2.5G cards reporting LOF. The alarm indicates that the receiving ONS 15454 has lost frame delineation in the incoming data. LOF occurs when the SONET overhead loses a valid framing pattern for 3 milliseconds. Receiving two consecutive valid A1/A2 framing patterns clears the alarm.

When the alarm is raised on an OC-N card, it is sometimes an indication that the OC-N card expects a specific line rate and the input line rate source does not match the input line rate of the optical receiver.



**Note**

For information about MXP or TXP cards, refer to the *Cisco ONS 15454 DWDM Reference Manual*.

### Clear the LOF (OCN) Alarm

- Step 1** Verify cabling continuity to the port reporting the alarm.



**Caution**

Always use the supplied electrostatic discharge wristband when working with a powered ONS 15454. Plug the wristband cable into the ESD jack located on the lower-right edge of the shelf assembly. To verify cable continuity, follow site practices.

- Step 2** If cabling continuity is good, clean the fiber according to site practice. If no site practice exists, complete the procedure in the “Maintain the Node” chapter of the *Cisco ONS 15454 Procedure Guide*.
- Step 3** If the alarm does not clear, see the loopback procedures in [Chapter 1, “General Troubleshooting”](#) to isolate the fault causing the LOF alarm.
- Step 4** If the alarm does not clear, or if you need assistance conducting network troubleshooting tests, call Cisco TAC to report a Service-Affecting (SA) problem 1 800 553-2447.

## 2.7.204 LOF (STSTRM)

Default Severity: Critical (CR), Service-Affecting (SA)

SONET Logical Object: STSTRM

A Loss of Frame alarm for an STS circuit termination indicates that the LOF has occurred at the terminating point of the circuit (such as an OC-N port). It is similar to the “[LOF \(OCN\)](#)” alarm on [page 2-152](#).

## Clear the LOF (STSTRM) Alarm

---

- Step 1** Complete the “[Clear the LOF \(OCN\) Alarm](#)” procedure on [page 2-152](#).
- Step 2** If the alarm does not clear, log into the Technical Support Website at <http://www.cisco.com/techsupport> for more information or call Cisco TAC 1 800 553-2447 in order to report a Service-Affecting (SA) problem.
- 

## 2.7.205 LOF (TRUNK)

For information about this alarm or condition, refer to the “Alarm Troubleshooting” chapter in the *Cisco ONS 15454 DWDM Troubleshooting Guide*. This guide discusses all DWDM alarms.

## 2.7.206 LOGBUFR90

Default Severity: Minor (MN), Non-Service-Affecting (NSA)

SONET Logical Object: SYSTEM

The Log Buffer Over 90 alarm indicates that the per-NE queue of incoming alarm, event, or update capacity of 5000 entries is over 90% full. LOGBUFR90 will clear if CTC recovers. If it does not clear, the LOGBUFROVFL alarm occurs.



**Note**

LOGBUFR90 is an informational alarm and does not require troubleshooting.

---

## 2.7.207 LOGBUFROVFL

Default Severity: Minor (MN), Non-Service-Affecting (NSA)

SONET Logical Object: SYSTEM

The Log Buffer Overflow alarm indicates that the CTC per-NE queue of incoming alarm, event, or updates, which has a capacity of 5000 entries, has overflowed. This happens only very rarely; if the alarm does occur, you must restart the CTC session. If this alarm occurs, it is likely that some updates are missing.

## Clear the LOGBUFROVFL Alarm

---

- Step 1** Restart the CTC session.

- Step 2** If the alarm does not clear, log into the Technical Support Website at <http://www.cisco.com/techsupport> for more information or call TAC (1-800-553-2447).
- 

## 2.7.208 LO-LASERBIAS

Default Severity: Minor (MN), Non-Service-Affecting (NSA)

SONET Logical Objects: EQPT, OCN

DWDM Logical Object: PPM

The Equipment Low Transmit Laser Bias Current alarm is raised against the TXP and MXP card laser performance. The alarm indicates that the card laser has reached the minimum laser bias tolerance.

If the LO-LASERBIAS alarm threshold is set at 0 percent (the default), the laser's usability has ended. If the threshold is set at 5 percent to 10 percent, the card is still usable for several weeks or months before you need to replace it.



**Note**

For more information about provisioning MXP or TXP PPMs, refer to the “Provision Transponders and Muxponders” chapter of the *Cisco ONS 15454 DWDM Procedure Guide*. For more information about the cards themselves, refer to the *Cisco ONS 15454 DWDM Reference Manual*.

---

### Clear the LO-LASERBIAS Alarm

- Step 1** Complete the [“Physically Replace a Traffic Card” procedure on page 2-274](#).
- Step 2** If the alarm does not clear, log into the Technical Support Website at <http://www.cisco.com/techsupport> for more information or call Cisco TAC 1 800 553-2447.
- 

## 2.7.209 LO-LASERTEMP

Default Severity: Minor (MN), Non-Service-Affecting (NSA)

SONET Logical Objects: EQPT, OCN

DWDM Logical Object: PPM

The Equipment Low Laser Optical Transceiver Temperature alarm applies to the TXP and MXP cards. LO-LASERTEMP occurs when the internally measured transceiver temperature falls below the card setting by 35.6 degrees F or 2 degrees C. A laser temperature change affects the transmitted wavelength. (Two degrees Celsius is equivalent to about 200 picometers in the wavelength.)

When the TXP or MXP card raises this alarm, the laser is automatically shut off. The [“LOS \(OCN\)” alarm on page 2-165](#) is raised at the far-end node and the [“DUP-IPADDR” alarm on page 2-79](#) is raised at the near end. To verify the card laser temperature level, double-click the card in node view and click the **Performance > Optics PM > Current Values** tabs. Maximum, minimum, and average laser temperatures are shown in the Current column entries in the Laser Temp rows.



**Note**

For more information about provisioning MXP or TXP PPMs, refer to the “Provision Transponder and Muxponder Cards” chapter of the *Cisco ONS 15454 DWDM Procedure Guide*. For more information about the cards themselves, refer to the *Cisco ONS 15454 DWDM Reference Manual*.

## Clear the LO-LASERTEMP Alarm

- 
- Step 1** Complete the “[Reset a Traffic Card in CTC](#)” procedure on page 2-271 for the reporting MXP or TXP card.
- Step 2** If the alarm does not clear, complete the “[Physically Replace a Traffic Card](#)” procedure on page 2-274 for the reporting MXP or TXP card.
- Step 3** If the alarm does not clear, log into the Technical Support Website at <http://www.cisco.com/techsupport> for more information or call Cisco TAC 1 800 553-2447.
- 

## 2.7.210 LOM

Default Severity: Critical (CR), Service-Affecting (SA) for STSMON, STSTRM, TRUNK;  
Major (MJ) for VT-TERM

SONET Logical Objects: STSMON, STSTRM, VT-TERM

DWDM Logical Object: TRUNK

The Optical Transport Unit (OTU) Loss of Multiframe is a VCAT member alarm. (VCAT member circuits are independent circuits that are concatenated from different time slots into a higher-rate signal.) The alarm applies to OCN ports when the Multi Frame Alignment Signal (MFAS) overhead field is errored for more than five frames and persists for more than 3 milliseconds.

**Note**

Optical cards do not recognize the LOM. The system redirects the LOM alarm to the incoming side so any optical card can display this alarm as a TERM alarm.

## Clear the LOM Alarm

To clear the alarm, log into the Technical Support Website at <http://www.cisco.com/techsupport> for more information or call Cisco TAC 1 800 553-2447 in order to report a Service-Affecting (SA) problem.

## 2.7.211 LOP-P

Default Severity: Critical (CR), Service-Affecting (SA)

SONET Logical Objects: STSMON, STSTRM

A Loss of Pointer Path alarm indicates that the SONET path pointer in the overhead has been lost. LOP occurs when valid H1/H2 pointer bytes are missing from the overhead. Receiving equipment monitors the H1/H2 pointer bytes to locate the SONET payload. An LOP-P alarm occurs when eight, nine, or ten consecutive frames do not have valid pointer values. The alarm clears when three consecutive valid pointers are received.

The LOP-P alarm can occur when the received payload does not match the provisioned payload. The alarm is caused by a circuit type mismatch on the concatenation facility. For example, if an STS-1 is sent across a circuit provisioned for STS-3c, an LOP-P alarm occurs.

For the FC\_MR-4 card, an LOP-P is raised if a port is configured for a SONET signal but receives an SONET signal instead. (This information is contained in the H1 byte bits 5 and 6.)

## Clear the LOP-P Alarm



### Caution

Always use the supplied electrostatic discharge wristband when working with a powered ONS 15454. Plug the wristband cable into the ESD jack located on the lower-right edge of the shelf assembly.

- 
- Step 1** In node view, click the **Circuits** tab and view the alarmed circuit.
- Step 2** Verify the circuit size listed in the Size column. If the size is different from what is expected, such as an STS3c instead of an STS1, this causes the alarm.
- Step 3** If you have been monitoring the circuit with optical test equipment, a mismatch between the provisioned circuit size and the size expected by the test set can cause this alarm. For specific procedures to use the test set equipment, consult the manufacturer. Ensure that the test set monitoring is set up for the same size as the circuit provisioning.
- Refer to the manufacturer's instructions for test-set use.
- Step 4** If the error is not due to an incorrectly configured test set, the error is in the provisioned CTC circuit size. Complete the [“Delete a Circuit” procedure on page 2-276](#).
- Step 5** Recreate the circuit for the correct size. For procedures, refer to the “Create Circuits and VT Tunnels” chapter in the *Cisco ONS 15454 Procedure Guide*.
- Step 6** If the alarm does not clear, log into the Technical Support Website at <http://www.cisco.com/techsupport> for more information or call Cisco TAC 1 800 553-2447 in order to report a Service-Affecting (SA) problem.
- 

## 2.7.212 LOP-V

Default Severity: Major (MJ), Service-Affecting (SA)

SONET Logical Objects: VT-MON, VT-TERM

The LOP VT alarm indicates a loss of pointer at the VT level.

The LOP-V alarm can occur when the received payload does not match the provisioned payload. LOP-V is caused by a circuit size mismatch on the concatenation facility.

## Clear the LOP-V Alarm

- 
- Step 1** Complete the [“Clear the LOP-P Alarm” procedure on page 2-156](#).

**Caution**

Always use the supplied electrostatic discharge wristband when working with a powered ONS 15454. Plug the wristband cable into the ESD jack located on the lower-right edge of the shelf assembly.

**Step 2**

If the alarm does not clear, log into the Technical Support Website at <http://www.cisco.com/techsupport> for more information or call Cisco TAC 1 800 553-2447 in order to report a Service-Affecting (SA) problem.

## 2.7.213 LO-RXPOWER

Default Severity: Minor (MN), Non-Service-Affecting (NSA)

SONET Logical Object: OCN

DWDM Logical Objects: 2R, ESCON, FC, GE, ISC, TRUNK

The Equipment Low Receive Power alarm is an indicator for TXP\_MR\_10G, TXP\_MR\_2.5G, TXPP\_MR\_2.5G, TXP\_MR\_10E, MXP\_2.5G\_10G, MRC-12, MRC-4, and OC192-XFP card received optical signal power. LO-RXPOWER occurs when the measured optical power of the received signal falls below the threshold value, which is user-provisionable.

**Note**

For more information about MXP or TXP cards, refer to the *Cisco ONS 15454 DWDM Reference Manual*.

**Note**

When you upgrade a node to Software Release 6.0 or later, this enables received optical power PMs for the OC3-8, OC192-SR, OC192-IR, OC192-ITU, OC-192-XFP, MRC-12, and MRC25G-4 cards. The newly enabled HI-RXPOWER and LO-RXPOWER alarms require that you initialize a site-accepted optical power (OPR0) nominal value after the upgrade. (To do this, refer to the procedure in the “Turn Up a Node” chapter in the *Cisco ONS 15454 Procedure Guide*.) When you apply the value change, CTC uses the new OPR0 value to calculate PM percentage values. If you do not change the nominal value, the HI-RXPOWER or LO-RXPOWER may be raised in response to the unmodified setting.

### Clear the LO-RXPOWER Alarm

**Step 1**

At the transmit end of the errored circuit, increase the transmit power level within safe limits.

**Step 2**

Find out whether new channels have been added to the fiber. Up to 32 channels can be transmitted on the same fiber, but the number of channels affects power. If channels have been added, power levels of all channels need to be adjusted.

**Note**

If the card is part of an amplified DWDM system, adding channels on the fiber affects the transmission power of each channel more than it would in an unamplified system.

**Step 3**

Find out whether gain (the amplification power) of any amplifiers has been changed. Changing amplification also causes channel power to need adjustment.

- Step 4** If the alarm does not clear, remove any receive fiber attenuators or replace them with lower-resistance attenuators.
- Step 5** If the alarm does not clear, inspect and clean the receive and transmit node fiber connections according to site practice. If no site practice exists, complete the procedure in the “Maintain the Node” chapter in the *Cisco ONS 15454 Procedure Guide*.
- Step 6** If the alarm does not clear, ensure that the fiber is not broken or damaged by testing it with an optical test set. If no test set is available, use the fiber for a facility (line) loopback on a known-good port. The error reading you get is not as precise, but you generally know whether the fiber is faulty. For specific procedures to use the test set equipment, consult the manufacturer.
- Step 7** If the alarm does not clear, and no faults are present on the other port(s) of the transmit or receive card, do a facility loopback on the transmit and receive ports with known-good loopback cable. Complete the “1.4.1 Perform a Facility Loopback on a Source-Node Optical Port” procedure on page 1-48 or the “1.4.4 Perform a Facility Loopback on an Intermediate-Node Optical Port” procedure on page 1-57 to test the loopback.
- Step 8** If a port is bad and you need to use all the port bandwidth, complete the “Physically Replace a Traffic Card” procedure on page 2-274. If the port is bad but you can move the traffic to another port, replace the card at the next available maintenance window.
- Step 9** If no ports are shown bad and the alarm does not clear, log into the Technical Support Website at <http://www.cisco.com/techsupport> for more information or call Cisco TAC 1 800 553-2447.

## 2.7.214 LOS (2R)

For information about this alarm or condition, refer to the “Alarm Troubleshooting” chapter in the *Cisco ONS 15454 DWDM Troubleshooting Guide*. This guide discusses all DWDM alarms.

## 2.7.215 LOS (BITS)

Default Severity: Minor (MN), Non-Service-Affecting (NSA)

SONET Logical Object: BITS

The LOS (BITS) alarm indicates that the TCC2/TCC2P has an LOS from the BITS timing source. The LOS (BITS) means the BITS clock or the connection to it failed.

### Clear the LOS (BITS) Alarm



#### Caution

Always use the supplied electrostatic discharge wristband when working with a powered ONS 15454. Plug the wristband cable into the ESD jack located on the lower-right edge of the shelf assembly.

- Step 1** Verify the wiring connection from the BITS clock pin fields on the ONS 15454 backplane to the timing source.
- Step 2** If wiring is good, verify that the BITS clock is operating properly.

- Step 3** If the alarm does not clear, log into the Technical Support Website at <http://www.cisco.com/techsupport> for more information or call Cisco TAC 1 800 553-2447 in order to report a Service-Affecting (SA) problem.
- 

## 2.7.216 LOS (DS1)

Default Severity: Major (MJ), Service-Affecting (SA)

SONET Logical Object: DS1

A LOS (DS1) alarm for a DS-1 port occurs when the port on the card is in service but no signal is being received. A cabling issue or a configuration issue could cause this alarm. If an upstream equipment failure causes a transmission failure, the LOS (DS1) will likely be demoted by a card-level alarm (to the DS1/E1-56).

### Clear the LOS (DS1) Alarm



**Caution**

Always use the supplied electrostatic discharge wristband when working with a powered ONS 15454. Plug the wristband cable into the ESD jack located on the lower-right edge of the shelf assembly.

---

- Step 1** Verify that the fiber cable is properly connected and attached from the correct transmitting port to the correct receiving port. For more information about fiber connections and terminations, refer to the “Install Cards and Fiber-Optic Cable” chapter in the *Cisco ONS 15454 Procedure Guide*.
- Step 2** Clean the cable ends using site practices or, if none exists, complete the procedure in the “Maintain the Node” chapter of the *Cisco ONS 15454 Procedure Guide*.
- Step 3** If the alarm is raised on a DS1/E1-56 card, verify that the card is placed in the correct service mode by completing the following steps:
- Double-click the card to open the card view.
  - Click the **Provisioning > Card** tabs.
  - Verify that the **Operating Mode** column says All DS1 for your errored circuit.
- Step 4** For any other DS-1 or DS-3 card, consult site records to determine whether the port raising the alarm has been assigned.
- Step 5** If the port is not currently assigned, place the port out of service using the following steps:
- Double-click the card to open the card view.
  - For a DS-1 card, click the **Maintenance > Loopback** tabs. For a DS-1 line on a DS3XM-6 or DS3XM-12 card, click the **Maintenance > DS1** tabs.
  - Under Admin State, click **OOS,DSBLD**.
  - Click **Apply**.
- Step 6** For any card, if the port is assigned, verify that the correct one is in service:
- To confirm this physically, confirm that the LED is correctly illuminated on the physical card.  
A green ACT/SBY LED indicates an active card. An amber ACT/SBY LED indicates a standby card.

- b. To determine this virtually, double-click the card in CTC to open the card view and complete the following substeps:
- Click the **Provisioning > Line** tabs.
  - Verify that the Admin State column lists the port as IS.
  - If the Admin State column lists the port as OOS,MT or OOS,DSBLD, click the column and choose **IS**. Click **Apply**.



---

**Note** If ports managed into IS admin state are not receiving signals, the LOS alarm is either raised or remains, and the port service state transitions to OOS-AU,FLT.

---

- Step 7** Use a test set to confirm that a valid signal exists on the line. Test the line as close to the receiving card as possible. For specific procedures to use the test set equipment, consult the manufacturer.
- Step 8** Ensure that the transmit and receive outputs from the DSx patch panel to your equipment are properly connected. For more information about cable connections and terminations, refer to the “Install Cards and Fiber-Optic Cable” chapter in the *Cisco ONS 15454 Procedure Guide*.
- Step 9** If there is a valid signal but the alarm does not clear, replace the electrical connector on the ONS 15454.
- Step 10** If a valid electrical signal is not present and the transmitting device is operational, replace the fiber cable connecting the transmitting device to the Ethernet port. To do this, refer to the “Install Cards and Fiber-Optic Cable” chapter in the *Cisco ONS 15454 Procedure Guide*.
- Step 11** Repeat Steps 1 to 10 for any other port on the card that reports the LOS.
- Step 12** If the alarm does not clear, check for any card-level alarm that could affect this port.
- Step 13** If the alarm does not clear, complete the [“Physically Replace a Traffic Card” procedure on page 2-274](#) for the reporting card.
- Step 14** If the alarm does not clear, log into the Technical Support Website at <http://www.cisco.com/techsupport> for more information or call Cisco TAC 1 800 553-2447 in order to report a Service-Affecting (SA) problem.
- 

## 2.7.217 LOS (DS3)

Default Severity: Critical (CR), Service-Affecting (SA)

SONET Logical Object: DS3

The LOS (DS3) for a DS-3 port occurs when the port on a DS3XM-6, DS3XM-12, or DS3/EC1-48 card is in service but no signal is being received. The alarm is caused by incorrect or dirty cabling, a fiber break, or upstream equipment failure.



---

**Note** If a circuit shows a partial status when this alarm is raised, the logical circuit is in place. The circuit is able to carry traffic when the connection issue is resolved. You do not need to delete the circuit when troubleshooting this alarm.

---

## Clear the LOS (DS3) Alarm

- Step 1** Check for any upstream failures in the transmitting equipment.
- Step 2** Verify that the cable is properly connected from the transmitting port and attached to the correct receiving port at the node with the LOS. For more information about fiber connections and terminations, refer to the “Install Cards and Fiber-Optic Cable” chapter in the *Cisco ONS 15454 Procedure Guide*.



### Caution

Always use the supplied electrostatic discharge wristband when working with a powered ONS 15454. Plug the wristband cable into the ESD jack located on the lower-right edge of the shelf assembly.

- Step 3** Clean the cable ends using site practices or, if none exists, complete the procedure in the “Maintain the Node” chapter in the *Cisco ONS 15454 Procedure Guide*.
- Step 4** Consult site records to determine whether the port raising the alarm has been assigned.
- Step 5** If the port is not currently assigned, place the port out of service using the following steps:
- a. Double-click the card to open the card view.
  - b. Click the **Maintenance > DS3** tabs.
  - c. Under Admin State, click **OOS,DSBLD**.
  - d. Click **Apply**.
- Step 6** If the port is assigned, verify that the correct one is in service:
- a. To confirm this physically, confirm that the LED is correctly illuminated on the physical card.  
A green ACT/SBY LED indicates an active card. An amber ACT/SBY LED indicates a standby card.
  - b. To determine this virtually, double-click the card in CTC to open the card view and complete the following substeps:
    - Click the **Provisioning > Line** tabs.
    - Verify that the Admin State column lists the port as IS.
    - If the Admin State column lists the port as OOS,MT or OOS,DSBLD, click the column and choose **IS**. Click **Apply**.



### Note

If ports managed into IS admin state are not receiving signals, the LOS alarm is either raised or remains, and the port service state transitions to OOS-AU,FLT.

- Step 7** Use a test set to confirm that a valid signal exists on the line. Test the line as close to the receiving card as possible. (For specific procedures to use the test set equipment, consult the manufacturer.)
- Step 8** Ensure that the transmit and receive outputs from the DSx patch panel to your equipment are properly connected. For more information about cable connections and terminations, refer to the “Install Cards and Fiber-Optic Cable” chapter in the *Cisco ONS 15454 Procedure Guide*.
- Step 9** If there is a valid signal but the alarm does not clear, replace the electrical connector on the ONS 15454.
- Step 10** If the test set shows signal errors but the cabling is correctly installed and the transmitting device is operational, the existing cabling could still be faulty. Use the test set to locate the bad cable and replace it. To do this, refer to the “Install Cards and Fiber-Optic Cable” chapter in the *Cisco ONS 15454 Procedure Guide*.
- Step 11** Repeat Steps 1 to 10 for any other port on the card that reports the LOS.

- Step 12** If the alarm does not clear, complete the “[Physically Replace a Traffic Card](#)” procedure on page 2-274 for the reporting card.
- Step 13** If the alarm does not clear, log into the Technical Support Website at <http://www.cisco.com/techsupport> for more information or call Cisco TAC 1 800 553-2447 in order to report a Service-Affecting (SA) problem.

## 2.7.218 LOS (E1)

Default Severity: Major (MJ), Service-Affecting (SA)

SONET Logical Object: E1

An LOS (E1) alarm for a DS1/E1-56 card port occurs when the card is placed in All E1 mode and is in service, but the alarmed port is not receiving a signal due to a physical or provisioning problem. The physical causes for the alarm could be incorrectly connected or faulty cabling. The software causes could be improperly configured card or circuit size.

For more information about the DS1/E1-56 card, refer to the “Electrical Cards” chapter in the *Cisco ONS 15454 Reference Manual*.

### Clear the LOS (E1) Alarm



#### Caution

Always use the supplied electrostatic discharge wristband when working with a powered ONS 15454. Plug the wristband cable into the ESD jack located on the lower-right edge of the shelf assembly.

- Step 1** Verify that the cable is properly connected and attached to the correct port. For more information about connecting cable, refer to the “Install Cards and Fiber-Optic Cable” chapter in the *Cisco ONS 15454 Procedure Guide*. Also refer to site records for your specific cabling scheme.
- Step 2** Ensure that the transmit and receive outputs from the patch panel to your equipment are properly connected. For more information about cable connections and terminations, refer to the “Install Cards and Fiber-Optic Cable” chapter in the *Cisco ONS 15454 Procedure Guide*.
- Step 3** Clean the cable using your site practices. If none exists, complete the procedure in the “Maintain the Node” chapter in the *Cisco ONS 15454 Procedure Guide*.
- Step 4** Confirm that the card is properly provisioned to carry the E1 payload:
- a. Double-click the card to open the card view.
  - b. Click the **Provisioning > Card** tabs.
  - c. Under the **Operating Mode** column, you should see “All E1.” If you see “All DS1,” click the drop-down to change it and click **Apply**.
- Step 5** Use a test set to confirm that a valid E1 signal exists on the line. Test the line as close to the receiving card as possible. (For specific procedures to use the test set equipment, consult the manufacturer.) If the test set shows errors, the cabling could still be faulty despite being correctly installed. Use the tester to isolate the bad section of cable and replace it. Refer to the “Install Cards and Fiber-Optic Cable” chapter in the *Cisco ONS 15454 Procedure Guide* for procedures.
- Step 6** Repeat Steps 1 to 5 for any other port on the card that reports the LOS (E1).
- Step 7** If the alarm does not clear, look for any card-level alarm that could cause this alarm.



- Step 8** If the alarm does not clear, complete the “[Physically Replace a Traffic Card](#)” procedure on page 2-274 for the reporting card.
- Step 9** If the alarm does not clear, log into the Technical Support Website at <http://www.cisco.com/techsupport> for more information or call Cisco TAC 1 800 553-2447 in order to report a Service-Affecting (SA) problem.
- 

## 2.7.219 LOS (EC1)

Default Severity: Critical (CR), Service-Affecting (SA)

SONET Logical Object: EC1

LOS on an EC1/EC1-12 or DS3/EC1-48 port occurs when a SONET receiver detects an all-zero pattern for 10 microseconds or longer. An LOS (EC1) most likely means that the upstream transmitter has failed. If an EC1 LOS alarm is not accompanied by additional alarms, a cabling problem (such as an incorrect attachment, fiber cut, or other fiber error) usually causes this alarm. The condition clears when the problem is corrected, allowing two consecutive valid frames to be received.



### Note

If a circuit shows a partial status when this alarm is raised, the logical circuit is in place. The circuit is able to carry traffic when the connection issue is resolved. You do not need to delete the circuit when troubleshooting this alarm.

---

## Clear the LOS (EC1) Alarm



### Caution

Always use the supplied electrostatic discharge wristband when working with a powered ONS 15454. Plug the wristband cable into the ESD jack located on the lower-right edge of the shelf assembly.

---

- Step 1** Check for any upstream equipment failures that could cause the LOS (EC1) in this node.
- Step 2** If there is no cause upstream, verify cabling continuity from the transmitting port to the receiving port reporting LOS (EC1). To verify cable continuity, follow site practices.
- If the continuity is good, clean the fiber according to site practice. If none exists, complete the procedure in the “Maintain the Node” chapter in the *Cisco ONS 15454 Procedure Guide*.
- Step 3** If the cabling is good, verify that the correct EC1-12 port is in service:
- Confirm that the LED is correctly lit on the physical card.  
A green ACT/SBY LED indicates an active card. An amber ACT/SBY LED indicates a standby card.
  - To determine whether the port is in service, double-click the card in CTC to open the card view.
  - Click the **Provisioning > Line** tabs.
  - Verify that the Admin State column lists the port as IS.
  - If the Admin State column lists the port as OOS,MT or OOS,DSBLD, click the column and choose **IS**. Click **Apply**.

**Note**

If ports managed into IS admin state are not receiving signals, the LOS alarm is either raised or remains, and the port service state transitions to OOS-AU,FLT.

- 
- Step 4** If the correct port is in service, use an optical test set to confirm that a valid signal exists on the line. For specific procedures to use the test set equipment, consult the manufacturer. Test the line as close to the receiving card as possible.
- Step 5** If the signal is valid, ensure that the transmit and receive outputs from the patch panel to your equipment are properly connected. For more information about fiber connections and terminations, refer to the “Install Cards and Fiber-Optic Cable” chapter in the *Cisco ONS 15454 Procedure Guide*.
- Step 6** If a valid signal exists but the alarm does not clear, replace the cable connector on the ONS 15454.
- Step 7** Repeat Steps 2 through 6 for any other port on the card that reports the LOS (EC1).
- Step 8** If the alarm does not clear, the cabling could still be faulty despite correct attachments. Use the test set to locate the bad cable and replace it using the “Install Cards and Fiber-Optic Cable” chapter in the *Cisco ONS 15454 Procedure Guide*.
- Step 9** If the alarm does not clear, look for any card-level alarm that could cause this port alarm.
- Step 10** If the alarm does not clear, complete the [“Physically Replace a Traffic Card” procedure on page 2-274](#) for the reporting card.
- Step 11** If the alarm does not clear, log into the Technical Support Website at <http://www.cisco.com/techsupport> for more information or call Cisco TAC 1 800 553-2447 in order to report a Service-Affecting (SA) problem.
- 

## 2.7.220 LOS (ESCON)

For information about this alarm or condition, refer to the “Alarm Troubleshooting” chapter in the *Cisco ONS 15454 DWDM Troubleshooting Guide*. This guide discusses all DWDM alarms.

## 2.7.221 LOS (FUDC)

Default Severity: Minor (MN), Non-Service Affecting (NSA)

SONET Logical Object: FUDC

The LOS (FUDC) alarm is raised if there is a UDC circuit created on an AIC-I UDC port but the port is not receiving signal input. The downstream node has an AIS condition raised against the AIC-I port transmitting the UDC. FUDC refers to the 64-kb user data channel using the F1 byte.

### Clear the LOS (FUDC) Alarm

- 
- Step 1** Verify cable continuity to the AIC-I UDC port. To verify cable continuity, follow site practices.
- Step 2** Verify that there is a valid input signal using a test set. For specific procedures to use the test set equipment, consult the manufacturer.
- Step 3** If there is a valid signal, clean the fiber according to site practice. If no site practice exists, complete the procedure in the “Maintain the Node” chapter in the *Cisco ONS 15454 Procedure Guide*.

- Step 4** If the alarm does not clear, verify that the UDC is provisioned:
- At the network view, click the **Provisioning > Overhead Circuits** tabs.
  - If no UDC circuit exists, create one. Refer to the “Create Circuits and VT Tunnels” chapter in the *Cisco ONS 15454 Procedure Guide*.
  - If a user data circuit exists (shown as User Data F1 under the Type column), check the source and destination ports. These must be located on AIC-I cards to function.
- Step 5** If the alarm does not clear, look for and troubleshoot any other alarm that could identify the source of the problem.
- Step 6** If no other alarms exist that could be the source of the LOS (FUDC), or if clearing another alarm did not clear the LOS, complete the [“Physically Replace a Traffic Card” procedure on page 2-274](#) for the reporting card.
- Step 7** If the alarm does not clear, log into the Technical Support Website at <http://www.cisco.com/techsupport> for more information or call Cisco TAC 1 800 553-2447.
- 

## 2.7.222 LOS (ISC)

For information about this alarm or condition, refer to the “Alarm Troubleshooting” chapter in the *Cisco ONS 15454 DWDM Troubleshooting Guide*. This guide discusses all DWDM alarms.

## 2.7.223 LOS (MSUDC)

The LOS (MSUDC) alarm is not used in this platform in this release. It is reserved for future development.

## 2.7.224 LOS (OCN)

Default Severity: Critical (CR), Service-Affecting (SA)

SONET Logical Object: OCN

An LOS alarm on an OC-N port occurs when a SONET receiver detects an all-zero pattern for 10 microseconds or longer. An LOS alarm means the upstream transmitter has failed. If an OC-N LOS alarm is not accompanied by additional alarms, a fiber break is usually the cause of the alarm. It clears when two consecutive valid frames are received.



Warning

**On the OC-192 card, the laser is on when the card is booted and the safety key is in the on position (labeled 1). The port does not have to be in service for the laser to be on. The laser is off when the safety key is off (labeled 0).** Statement 293

---



Warning

**Invisible laser radiation could be emitted from the end of the unterminated fiber cable or connector. Do not stare into the beam directly with optical instruments. Viewing the laser output with certain optical instruments (for example, eye loupes, magnifiers, and microscopes) within a distance of 100 mm could pose an eye hazard.** Statement 1056

---

**Warning**

**Use of controls, adjustments, or performing procedures other than those specified could result in hazardous radiation exposure.** Statement 1057

**Note**

If a circuit shows a partial status when this alarm is raised, the logical circuit is in place. The circuit is able to carry traffic when the connection issue is resolved. You do not need to delete the circuit when troubleshooting this alarm.

## Clear the LOS (OCN) Alarm

**Caution**

Always use the supplied electrostatic discharge wristband when working with a powered ONS 15454. Plug the wristband cable into the ESD jack located on the lower-right edge of the shelf assembly.

**Step 1** Using site practices, verify fiber continuity to the port.

**Step 2** If the cabling is good, verify that the correct port is in service:

- a. Confirm that the LED is correctly illuminated on the physical card.  
A green ACT/SBY LED indicates an active card. An amber ACT/SBY LED indicates a standby card.
- b. To determine whether the OC-N port is in service, double-click the card in CTC to open the card view.
- c. Click the **Provisioning > Line** tabs.
- d. Verify that the Admin State column lists the port as IS.
- e. If the Admin State column lists the port as OOS,MT or OOS,DSBLD, click the column and choose **IS**.
- f. Click **Apply**.

**Note**

If ports managed into IS admin state are not receiving signals, the LOS alarm is either raised or remains, and the port service state transitions to OOS-AU,FLT.

**Step 3** If the correct port is in service, clean the fiber according to site practice. If no site practice exists, complete the procedure in the “Maintain the Node” chapter of the *Cisco ONS 15454 Procedure Guide*.

**Step 4** If the alarm does not clear, verify that the power level of the optical signal is within the OC-N card receiver specifications. The “[1.12.3 OC-N Card Transmit and Receive Levels](#)” section on [page 1-145](#) lists these specifications for each OC-N card. For DWDM cards, refer to the *Cisco ONS 15454 DWDM Reference Manual* for levels.

**Step 5** If the optical power level is within specifications, use an optical test set to verify that a valid signal exists on the line. For specific procedures to use the test set equipment, consult the manufacturer. Test the line as close to the receiving card as possible.

**Step 6** If a valid signal exists, replace the connector on the backplane.

**Step 7** Repeat Steps 1 to 6 for any other port on the card reporting the LOS (OC-N).

**Step 8** If the alarm does not clear, look for and troubleshoot any other alarm that could identify the source of the problem.

- Step 9** If no other alarms exist that could be the source of the LOS, or if clearing an alarm did not clear the LOS, complete the “[Physically Replace a Traffic Card](#)” procedure on page 2-274 for the reporting card.
- Step 10** If the alarm does not clear, log into the Technical Support Website at <http://www.cisco.com/techsupport> for more information or call Cisco TAC 1 800 553-2447 in order to report a Service-Affecting (SA) problem.
- 

## 2.7.225 LOS (OTS)

For information about this alarm or condition, refer to the “Alarm Troubleshooting” chapter in the *Cisco ONS 15454 DWDM Troubleshooting Guide*. This guide discusses all DWDM alarms.

## 2.7.226 LOS (TRUNK)

For information about this alarm or condition, refer to the “Alarm Troubleshooting” chapter in the *Cisco ONS 15454 DWDM Troubleshooting Guide*. This guide discusses all DWDM alarms.

## 2.7.227 LOS-0

For information about this alarm or condition, refer to the “Alarm Troubleshooting” chapter in the *Cisco ONS 15454 DWDM Troubleshooting Guide*. This guide discusses all DWDM alarms.

## 2.7.228 LOS-P (OCH)

For information about this alarm or condition, refer to the “Alarm Troubleshooting” chapter in the *Cisco ONS 15454 DWDM Troubleshooting Guide*. This guide discusses all DWDM alarms.

## 2.7.229 LOS-P (OMS, OTS)

For information about this alarm or condition, refer to the “Alarm Troubleshooting” chapter in the *Cisco ONS 15454 DWDM Troubleshooting Guide*. This guide discusses all DWDM alarms.

## 2.7.230 LOS-P (TRUNK)

For information about this alarm or condition, refer to the “Alarm Troubleshooting” chapter in the *Cisco ONS 15454 DWDM Troubleshooting Guide*. This guide discusses all DWDM alarms.

## 2.7.231 LO-TXPOWER

Default Severity: Minor (MN), Non-Service-Affecting (NSA)

SONET Logical Objects: EQPT, OCN

DWDM Logical Objects: 2R, ESCON, FC, GE, ISC, PPM

The Equipment Low Transmit Power alarm is an indicator for the TXP\_MR\_10G, TXP\_MR\_2.5G, TXPP\_MR\_2.5G, TXP\_MR\_10E, MXP\_2.5G\_10G, MRC-12, MRC-4, and OC192-XFP card transmitted optical signal power. LO-TXPOWER occurs when the measured optical power of the transmitted signal falls under the threshold. The threshold value is user-provisionable.

**Note**

For more information about provisioning MXP or TXP PPMs, refer to the “Provision Transponders and Muxponders” chapter of the *Cisco ONS 15454 DWDM Procedure Guide*. For more information about the cards themselves, refer to the *Cisco ONS 15454 DWDM Reference Manual*.

## Clear the LO-TXPOWER Alarm

- 
- Step 1** Display the TXP\_MR\_10G, TXP\_MR\_2.5G, TXPP\_MR\_2.5G, TXP\_MR\_10E, MXP\_2.5G\_10G, or OC192-XFP card view.
  - Step 2** Click the **Provisioning > Optics Thresholds > Current Values** tabs.
  - Step 3** Increase the TX Power Low column value by 0.5 dBm.
  - Step 4** If the card transmit power setting cannot be increased without affecting the signal, complete the [“Physically Replace a Traffic Card” procedure on page 2-274](#).
  - Step 5** If no ports are shown bad and the alarm does not clear, log into the Technical Support Website at <http://www.cisco.com/techsupport> for more information or call Cisco TAC 1 800 553-2447.
- 

## 2.7.232 LPBKCRS

Default Severity: Not Alarmed (NA), Non-Service-Affecting (NSA)

SONET Logical Objects: STSMON, STSTRM

The Loopback Cross-Connect condition indicates that there is a software cross-connect loopback active between the optical cards. A cross-connect loopback test occurs below line speed and does not affect traffic.

For more information on loopbacks, see the [“1.4 Troubleshooting Optical Circuit Paths With Loopbacks” section on page 1-47](#).

**Note**

Cross-connect loopbacks occur below line speed. They do not affect traffic.

## Clear the LPBKCRS Condition

- 
- Step 1** To remove the loopback cross-connect condition, double-click the optical card in CTC to open the card view.
  - Step 2** Complete the [“Clear an OC-N Card Cross-Connect \(XC\) Loopback Circuit” procedure on page 2-277](#).
  - Step 3** If the condition does not clear, log into the Technical Support Website at <http://www.cisco.com/techsupport> for more information or call Cisco TAC 1 800 553-2447.
-

## 2.7.233 LPBKDS3FEAC

Default Severity: Not Alarmed (NA), Non-Service-Affecting (NSA)

SONET Logical Object: DS3

A Loopback Due to FEAC Command DS-3 condition occurs when a DS3XM-6, DS3XM-12, DS3-12E, or DS3/EC1-48 port loopback signal is received in C-bit framing mode from the far-end node because of an FEAC command. An FEAC command is often used with loopbacks. LPBKDS3FEAC is only reported by these DS cards. DS3XM-6, DS3XM-12, and DS3/EC1-48 cards generate and report FEAC alarms or conditions, but a DS3-12E card only reports FEAC alarms or conditions.



**Caution**

---

CTC permits loopbacks on an in-service (IS) circuit. Loopbacks are Service-Affecting (SA).

---



**Note**

---

LPBKDS3FEAC is an informational condition and does not require troubleshooting.

---

### Clear the LPBKDS3FEAC Condition

- 
- Step 1** In node view, double-click the DS-3 card to open the card view.
  - Step 2** Click the **Maintenance > DS3** tabs.
  - Step 3** Click the cell for the port in the Send Code column and click **No Code** from the drop-down list.
  - Step 4** If the condition does not clear, log into the Technical Support Website at <http://www.cisco.com/techsupport> for more information or call Cisco TAC 1 800 553-2447.
- 

## 2.7.234 LPBKDS3FEAC-CMD

Default Severity: Not Alarmed (NA), Non-Service-Affecting (NSA)

SONET Logical Object: DS3

The DS-3 Loopback Command Sent To Far End condition occurs on the near-end node when you send a DS-3 FEAC loopback on DS3XM-6, DS3XM-12, or DS3/EC1-48 cards. For more information about FEAC loopbacks, see the “[1.3 Troubleshooting DS3XM-6 or DS3XM-12 Card Electrical Paths With FEAC Loopbacks](#)” section on page 1-45.



**Note**

---

LPBKDS3FEAC-CMD is an informational condition and does not require troubleshooting.

---

## 2.7.235 LPBKFACILITY (CE1000, CE100T)

Default Severity: Not Alarmed (NA), Non-Service-Affecting (NSA)

SONET Logical Objects: CE1000, CE100T

A Loopback Facility condition on a CE-Series port occurs when a software facility (line) loopback is active for a port on the card.

**Note**

For information about troubleshooting Ethernet circuits with loopbacks, refer to the [“1.5 Troubleshooting Ethernet Circuit Paths With Loopbacks”](#) section on page 1-68.

**Note**

For more information about Ethernet cards, refer to the *Cisco ONS 15454 and Cisco ONS 15454 SDH Ethernet Card Software Feature and Configuration Guide*.

## Clear the LPBKFACILITY (CE1000, CE100T) Condition

- 
- Step 1** Complete the [“Clear Other Electrical Card or Ethernet Card Loopbacks”](#) procedure on page 2-278.
- Step 2** If the condition does not clear, log into the Technical Support Website at <http://www.cisco.com/techsupport> for more information or call Cisco TAC 1 800 553-2447.
- 

## 2.7.236 LPBKFACILITY (DS1, DS3)

Default Severity: Not Alarmed (NA), Non-Service-Affecting (NSA)

SONET Logical Objects: DS1, DS3

A Loopback Facility condition on a DS-1 or DS-3 port occurs when a software facility (line) loopback is active for the reporting DS3XM-6 card, DS3XM-12 card, a DS1/E1-56 card operating in All DS1 mode, or a DS3/EC1-48 card.

For information about troubleshooting electrical circuits with loopbacks, refer to the [“1.2 Troubleshooting Electrical Circuit Paths With Loopbacks”](#) section on page 1-9.

**Note**

CTC permits loopbacks to be performed on an in-service (IS) circuit. Performing a loopback is Service-Affecting (SA). If you did not perform a lockout or Force switch to protect traffic, the LPBKFACILITY condition can be accompanied by a more serious alarms such as the [“LOS \(DS1\)”](#) alarm on page 2-159, or the [“LOS \(DS3\)”](#) alarm on page 2-160.

**Note**

ONS 15454 DS-3 terminal (inward) loopbacks do not transmit an [“AIS”](#) alarm on page 2-37, in the direction away from the loopback. Instead of AIS, a continuance of the signal transmitted into the loopback is provided. A DS3/EC1-48 card can be provisioned to transmit AIS for a terminal loopback if desired.

## Clear the LPBKFACILITY (DS1, DS3) Condition

- 
- Step 1** Complete the [“Clear a DS3XM-6, DS3XM-12, or DS3E-12 Card Loopback Circuit”](#) procedure on page 2-277.



- Step 2** If the condition does not clear, log into the Technical Support Website at <http://www.cisco.com/techsupport> for more information or call Cisco TAC 1 800 553-2447.
- 

## 2.7.237 LPBKFACILITY (E1)

Default Severity: Not Alarmed (NA), Non-Service-Affecting (NSA)

SONET Logical Object: E1

A Loopback Facility on an E1 port condition occurs when a software facility (line) loopback is active for a DS1/E1-56 card port operating in All E1 mode.

For information about troubleshooting electrical circuits with loopbacks, refer to the “1.2 Troubleshooting Electrical Circuit Paths With Loopbacks” section on page 1-9.



**Note**

CTC permits loopbacks to be performed on an in-service (IS) circuit. Performing a loopback is Service-Affecting (SA). If you did not perform a lockout or Force switch to protect traffic, the LPBKFACILITY condition can be accompanied by a more serious alarms such as LOS.

---



**Note**

E1 facility (line) loopbacks transmit an AIS in the direction away from the loopback, but this is provisionable.

---

## Clear the LPBKFACILITY (E1) Condition

- Step 1** Complete the “[Clear Other Electrical Card or Ethernet Card Loopbacks](#)” procedure on page 2-278.
- Step 2** If the condition does not clear, log into the Technical Support Website at <http://www.cisco.com/techsupport> for more information or call Cisco TAC 1 800 553-2447.
- 

## 2.7.238 LPBKFACILITY (EC1)

Default Severity: Not Alarmed (NA), Non-Service-Affecting (NSA)

SONET Logical Object: EC1

A Loopback Facility condition on an EC-1 port occurs when a software facility (line) loopback is active for a port on the reporting EC1/EC1-12 or DS3/EC1-48 card.

For information about troubleshooting electrical circuits with loopbacks, refer to the “1.2 Troubleshooting Electrical Circuit Paths With Loopbacks” section on page 1-9.



**Caution**

CTC permits loopbacks on an in-service (IS) circuit. Loopbacks are Service-Affecting (SA).

---

## Clear the LPBKFACILITY (EC1) Condition

- 
- Step 1** Complete the [“Clear Other Electrical Card or Ethernet Card Loopbacks”](#) procedure on page 2-278.
- Step 2** If the condition does not clear, log into the Technical Support Website at <http://www.cisco.com/techsupport> for more information or call Cisco TAC 1 800 553-2447.
- 

## 2.7.239 LPBKFACILITY (ESCON)

For information about this alarm or condition, refer to the “Alarm Troubleshooting” chapter in the *Cisco ONS 15454 DWDM Troubleshooting Guide*. This guide discusses all DWDM alarms.

## 2.7.240 LPBKFACILITY (FC)

For information about this alarm or condition, refer to the “Alarm Troubleshooting” chapter in the *Cisco ONS 15454 DWDM Troubleshooting Guide*. This guide discusses all DWDM alarms.

## 2.7.241 LPBKFACILITY (FCMR)

Default Severity: Not Alarmed (NA), Non-Service-Affecting (NSA)

SONET Logical Object: FCMR

A Loopback Facility for FCMR condition occurs when a facility loopback is provisioned on an FC\_MR-4 card.

For information about troubleshooting these circuits with loopbacks, refer to the [“1.6 Troubleshooting FC\\_MR Circuit Paths With Loopbacks”](#) section on page 1-94.

## Clear the LPBKFACILITY (FCMR) Condition

- 
- Step 1** Complete the [“Clear an MXP, TXP, or FC\\_MR-4 Card Loopback Circuit”](#) procedure on page 2-278.
- Step 2** If the condition does not clear, log into the Technical Support Website at <http://www.cisco.com/techsupport> for more information or call Cisco TAC 1 800 553-2447.
- 

## 2.7.242 LPBKFACILITY (G1000)

Default Severity: Not Alarmed (NA), Non-Service-Affecting (NSA)

SONET Logical Object: G1000

A Loopback Facility condition for the G1000 object occurs when a software facility (line) loopback is active for a port on the reporting G-Series Ethernet card.

For information about troubleshooting Ethernet circuits with loopbacks, refer to the [“1.5 Troubleshooting Ethernet Circuit Paths With Loopbacks”](#) section on page 1-68.

**Caution**

CTC permits loopbacks on an in-service (IS) circuit. Loopbacks are Service-Affecting (SA).

**Note**

For more information about Ethernet cards, refer to the *Cisco ONS 15454 and Cisco ONS 15454 SDH Ethernet Card Software Feature and Configuration Guide*.

## Clear the LPBKFACILITY (G1000) Condition

- Step 1** Complete the “[Clear Other Electrical Card or Ethernet Card Loopbacks](#)” procedure on page 2-278.
- Step 2** If the condition does not clear, log into the Technical Support Website at <http://www.cisco.com/techsupport> for more information or call Cisco TAC 1 800 553-2447.

## 2.7.243 LPBKFACILITY (GE)

For information about this alarm or condition, refer to the “Alarm Troubleshooting” chapter in the *Cisco ONS 15454 DWDM Troubleshooting Guide*. This guide discusses all DWDM alarms.

## 2.7.244 LPBKFACILITY (ISC)

For information about this alarm or condition, refer to the “Alarm Troubleshooting” chapter in the *Cisco ONS 15454 DWDM Troubleshooting Guide*. This guide discusses all DWDM alarms.

## 2.7.245 CLPBKFACILITY (OCN)

Default Severity: Not Alarmed (NA), Non-Service-Affecting (NSA)

SONET Logical Object: OCN

A Loopback Facility condition for an OC-N port occurs when a software facility (line) loopback is active for a port on the reporting OC-N card.

For information about troubleshooting optical circuits with loopbacks, refer to the “[1.4 Troubleshooting Optical Circuit Paths With Loopbacks](#)” section on page 1-47.

**Note**

OC-3 facility loopbacks do not transmit an AIS in the direction away from the loopback. Instead of AIS, a continuance of the signal transmitted to the loopback is provided.

**Caution**

CTC permits loopbacks on an in-service (IS) circuit. Loopbacks are Service-Affecting (SA).

**Caution**

Before performing a facility (line) loopback on an OC-N card, ensure that the card contains at least two DCC paths to the node where the card is installed. A second DCC path provides a nonlooped path to log into the node after the loopback is applied, thus enabling you to remove the facility loopback. Ensuring a second DCC is not necessary if you are directly connected to the ONS 15454 containing the loopback OC-N.

**Clear the LPBKFACILITY (OCN) Condition**

- 
- Step 1** Complete the “[Clear an OC-N Card Facility or Terminal Loopback Circuit](#)” procedure on page 2-276.
- Step 2** If the condition does not clear, log into the Technical Support Website at <http://www.cisco.com/techsupport> for more information or call Cisco TAC 1 800 553-2447.
- 

**2.7.246 LPBKFACILITY (TRUNK)**

For information about this alarm or condition, refer to the “Alarm Troubleshooting” chapter in the *Cisco ONS 15454 DWDM Troubleshooting Guide*. This guide discusses all DWDM alarms.

**2.7.247 LPBKTERMINAL (CE1000, CE100T)**

Default Severity: Not Alarmed (NA), Non-Service-Affecting (NSA)

SONET Logical Objects: CE1000, CE100T,

A Loopback Terminal condition on a CE-Series port occurs when a software terminal loopback is active for a port on the card.

**Note**

For information about troubleshooting Ethernet circuits with loopbacks, refer to the “[1.5 Troubleshooting Ethernet Circuit Paths With Loopbacks](#)” section on page 1-68.

**Note**

For more information about Ethernet cards, refer to the *Cisco ONS 15454 and Cisco ONS 15454 SDH Ethernet Card Software Feature and Configuration Guide*.

**Clear the LPBKTERMINAL (CE1000, CE100T) Condition**

- 
- Step 1** Complete the “[Clear Other Electrical Card or Ethernet Card Loopbacks](#)” procedure on page 2-278.
- Step 2** If the condition does not clear, log into the Technical Support Website at <http://www.cisco.com/techsupport> for more information or call Cisco TAC 1 800 553-2447.
-

## 2.7.248 LPBKTERMINAL (DS1, DS3)

Default Severity: Not Alarmed (NA), Non-Service-Affecting (NSA)

SONET Logical Objects: DS1, DS3

A Loopback Terminal condition for a DS-1 or DS-3 occurs when a software terminal (inward) loopback is active for a DS1 or DS3 port on the reporting DS3XM-6, DS3XM-12, or DS3/EC1-48 card. DS-1 and DS-3 terminal loopbacks do not typically return an AIS signal, but you can provision one for the DS3/EC1-48 card.

For information about troubleshooting electrical circuits with loopbacks, refer to the [“1.3 Troubleshooting DS3XM-6 or DS3XM-12 Card Electrical Paths With FEAC Loopbacks”](#) section on page 1-45.

### Clear the LPBKTERMINAL (DS1, DS3) Condition

- 
- Step 1** Complete the [“Clear a DS3XM-6, DS3XM-12, or DS3E-12 Card Loopback Circuit”](#) procedure on page 2-277.
- Step 2** If the condition does not clear, log into the Technical Support Website at <http://www.cisco.com/techsupport> for more information or call Cisco TAC 1 800 553-2447.
- 

## 2.7.249 LPBKTERMINAL (E1)

Default Severity: Not Alarmed (NA), Non-Service-Affecting (NSA)

SONET Logical Object: E1

A Loopback Terminal condition for an E-1 signal on a DS1/E1-56 card occurs when the card is operating in All E1 mode and a software terminal (inward) loopback is active for a port.

For information about troubleshooting electrical circuits with loopbacks, refer to the [“1.3 Troubleshooting DS3XM-6 or DS3XM-12 Card Electrical Paths With FEAC Loopbacks”](#) section on page 1-45.

### Clear the LPBKTERMINAL (E1) Condition

- 
- Step 1** Complete the [“Clear Other Electrical Card or Ethernet Card Loopbacks”](#) procedure on page 2-278.
- Step 2** If the condition does not clear, log into the Technical Support Website at <http://www.cisco.com/techsupport> for more information or call Cisco TAC 1 800 553-2447.
- 

## 2.7.250 LPBKTERMINAL (EC1)

Default Severity: Not Alarmed (NA), Non-Service-Affecting (NSA)

SONET Logical Object: EC1

A Loopback Terminal condition on an EC-1 signal occurs when a software terminal (inward) loopback is active for a port on the reporting EC1/EC1-12 or DS3/EC1-48 card.

For information about troubleshooting electrical circuits with loopbacks, refer to the “1.2 Troubleshooting Electrical Circuit Paths With Loopbacks” section on page 1-9.

**Caution**

CTC permits loopbacks on an in-service (IS) circuit. Loopbacks are Service-Affecting (SA).

## Clear the LPBKTERMINAL (EC1) Condition

- 
- Step 1** Complete the “[Clear Other Electrical Card or Ethernet Card Loopbacks](#)” procedure on page 2-278.
- Step 2** If the condition does not clear, log into the Technical Support Website at <http://www.cisco.com/techsupport> for more information or call Cisco TAC 1 800 553-2447.
- 

## 2.7.251 LPBKTERMINAL (ESCON)

For information about this alarm or condition, refer to the “Alarm Troubleshooting” chapter in the *Cisco ONS 15454 DWDM Troubleshooting Guide*. This guide discusses all DWDM alarms.

## 2.7.252 LPBKTERMINAL (FC)

For information about this alarm or condition, refer to the “Alarm Troubleshooting” chapter in the *Cisco ONS 15454 DWDM Troubleshooting Guide*. This guide discusses all DWDM alarms.

## 2.7.253 LPBKTERMINAL (FCMR)

Default Severity: Not Alarmed (NA), Non-Service-Affecting (NSA)

SONET Logical Object: FCMR

A Loopback Terminal for FCMR condition occurs when a terminal loopback is provisioned on an FC\_MR-4 card.

For information about troubleshooting these circuits with loopbacks, refer to the “1.6 Troubleshooting FC\_MR Circuit Paths With Loopbacks” section on page 1-94.

## Clear the LPBKTERMINAL (FCMR) Condition

- 
- Step 1** Complete the “[Clear an MXP, TXP, or FC\\_MR-4 Card Loopback Circuit](#)” procedure on page 2-278.
- Step 2** If the condition does not clear, log into the Technical Support Website at <http://www.cisco.com/techsupport> for more information or call Cisco TAC 1 800 553-2447.
-

## 2.7.254 LPBKTERMINAL (G1000)

Default Severity: Not Alarmed (NA), Non-Service-Affecting (NSA)

SONET Logical Object: G1000

A Loopback Terminal condition for the G1000 occurs when a software terminal (inward) loopback is active for a port on the reporting G-Series Ethernet card.

When a port in terminal (inward) loopback, its outgoing signal is redirected into the receive direction on the same port, and the externally received signal is ignored. On the G1000-4 card, the outgoing signal is not transmitted; it is only redirected in the receive direction.

For more information about troubleshooting Ethernet circuits, refer to the “[1.5 Troubleshooting Ethernet Circuit Paths With Loopbacks](#)” section on page 1-68.

**Caution**

CTC permits loopbacks on an in-service (IS) circuit. Loopbacks are Service-Affecting (SA).

**Note**

For more information about Ethernet cards, refer to the *Cisco ONS 15454 and Cisco ONS 15454 SDH Ethernet Card Software Feature and Configuration Guide*.

### Clear the LPBKTERMINAL (G1000) Condition

- Step 1** Complete the “[Clear Other Electrical Card or Ethernet Card Loopbacks](#)” procedure on page 2-278.
- Step 2** If the condition does not clear, log into the Technical Support Website at <http://www.cisco.com/techsupport> for more information or call Cisco TAC 1 800 553-2447.

## 2.7.255 LPBKTERMINAL (GE)

For information about this alarm or condition, refer to the “Alarm Troubleshooting” chapter in the *Cisco ONS 15454 DWDM Troubleshooting Guide*. This guide discusses all DWDM alarms.

## 2.7.256 LPBKTERMINAL (ISC)

For information about this alarm or condition, refer to the “Alarm Troubleshooting” chapter in the *Cisco ONS 15454 DWDM Troubleshooting Guide*. This guide discusses all DWDM alarms.

## 2.7.257 LPBKTERMINAL (OCN)

Default Severity: Not Alarmed (NA), Non-Service-Affecting (NSA)

SONET Logical Object: OCN

A Loopback Terminal condition for an OC-N port occurs when a software terminal (inward) loopback is active for a port on the reporting card.

**Note**

---

OC-N terminal loopbacks do not typically return an AIS.

---

**Note**

---

Performing a loopback on an in-service circuit is Service-Affecting (SA). If you did not perform a lockout or Force switch to protect traffic, the LPBKTERMINAL condition can also be accompanied by a more serious alarm such as LOS.

---

For information about troubleshooting circuits, refer to the loopback procedures in [Chapter 1, “General Troubleshooting.”](#)

## Clear the LPBKTERMINAL (OCN) Condition

- 
- Step 1** Complete the [“Clear an OC-N Card Facility or Terminal Loopback Circuit”](#) procedure on page 2-276.
- Step 2** If the condition does not clear, log into the Technical Support Website at <http://www.cisco.com/techsupport> for more information or call Cisco TAC 1 800 553-2447.
- 

## 2.7.258 LPBKTERMINAL (TRUNK)

For information about this alarm or condition, refer to the “Alarm Troubleshooting” chapter in the *Cisco ONS 15454 DWDM Troubleshooting Guide*. This guide discusses all DWDM alarms.

## 2.7.259 LWBATVG

Default Severity: Major (MJ), Service-Affecting (SA)

SONET Logical Object: PWR

The Low Voltage Battery alarm occurs in a –48 VDC environment when a battery lead input voltage falls below the low power threshold. This threshold, with a default value of –44 VDC, is user-provisionable. The alarm remains raised until the voltage remains above the threshold for 120 seconds. (For information about changing this threshold, refer to the “Turn Up Node” chapter in the *Cisco ONS 15454 Procedure Guide*.)

## Clear the LWBATVG Alarm

- 
- Step 1** The problem is external to the ONS 15454. Troubleshoot the power source supplying the battery leads.
- Step 2** If the alarm does not clear, log into the Technical Support Website at <http://www.cisco.com/techsupport> for more information or call Cisco TAC 1 800 553-2447 in order to report a Service-Affecting (SA) problem.
-



## 2.7.260 MAN-REQ

Default Severity: Not Alarmed (NA), Non-Service-Affecting (NSA)

SONET Logical Objects: EQPT, ML1000, ML100T, MLFX, STSMON, VT-MON

The Manual Switch Request condition occurs on a SONET entity when a user initiates a Manual switch request on an OC-N port. Clearing the Manual switch clears the MAN-REQ condition. You do not need to clear the switch if you want the Manual switch to remain.

MAN-REQ is raised for an IEEE 802.17b-based RPR span if the manual switch was requested in the Cisco IOS CLI with the “rpr-ieee protection request manual-switch {east | west}” command. It clears from the IEEE 802.17b-based RPR span when you remove the switch in the CLI. For the RPR-IEEE, MAN-REQ suppresses the “RPR-SD” alarm on page 2-214, and the “WTR” alarm on page 2-259. This condition is suppressed by the following alarms:

- [FORCED-REQ](#), page 112
- [RPR-PASSTHR](#), page 210
- [RPR-SF](#), page 215

### Clear the MAN-REQ Condition

- 
- Step 1** If the condition is raised against a SONET entity, complete the “[Initiate a 1+1 Manual Switch Command](#)” procedure on page 2-263.
- Step 2** If the condition is raised on an IEEE 802.17b-based RPR span, enter the following CLI command in RPR-IEEE interface configuration mode:
- ```
router(config-if)#no rpr-ieee protection request manual-switch {east | west}
```
- Step 3** If the condition does not clear, log into the Technical Support Website at <http://www.cisco.com/techsupport> for more information or call Cisco TAC 1 800 553-2447.
-

2.7.261 MANRESET

Default Severity: Not Alarmed (NA), Non-Service-Affecting (NSA)

SONET Logical Object: EQPT

A User-Initiated Manual Reset condition occurs when you right-click a card in CTC and choose Reset.



Note

MANRESET is an informational condition and does not require troubleshooting.

2.7.262 MANSWTOINT

Default Severity: Not Alarmed (NA), Non-Service-Affecting (NSA)

SONET Logical Object: NE-SREF

The Manual Switch To Internal Clock condition occurs when the NE timing source is manually switched to an internal timing source.

**Note**

MANSWTOINT is an informational condition and does not require troubleshooting.

2.7.263 MANSWTOPRI

Default Severity: Not Alarmed (NA), Non-Service-Affecting (NSA)

SONET Logical Objects: EXT-SREF, NE-SREF

The Manual Switch To Primary Reference condition occurs when the NE timing source is manually switched to the primary timing source.

**Note**

MANSWTOPRI is an informational condition and does not require troubleshooting.

2.7.264 MANSWTOSEC

Default Severity: Not Alarmed (NA), Non-Service-Affecting (NSA)

SONET Logical Objects: EXT-SREF, NE-SREF

The Manual Switch To Second Reference condition occurs when the NE timing source is manually switched to a second timing source.

**Note**

MANSWTOSEC is an informational condition and does not require troubleshooting.

2.7.265 MANSWTOTHIRD

Default Severity: Not Alarmed (NA), Non-Service-Affecting (NSA)

SONET Logical Objects: EXT-SREF, NE-SREF

The Manual Switch To Third Reference condition occurs when the NE timing source is manually switched to a third timing source.

**Note**

MANSWTOTHIRD is an informational condition and does not require troubleshooting.

2.7.266 MANUAL-REQ-RING

Default Severity: Not Alarmed (NA), Non-Service-Affecting (NSA)

SONET Logical Object: OCN

The Manual Switch Request on Ring condition occurs when a user initiates a MANUAL RING command on BLSR rings to switch from working to protect or protect to working. This condition is visible on the network view Alarms, Conditions, and History tabs and is accompanied by WKSWPR. The port where the MANUAL RING command originated is marked with an “M” on the network view detailed circuit map.

Clear the MANUAL-REQ-RING Condition

-
- Step 1** Complete the “[Clear a BLSR External Switching Command](#)” procedure on page 2-270.
- Step 2** If the condition does not clear, log into the Technical Support Website at <http://www.cisco.com/techsupport> for more information or call Cisco TAC 1 800 553-2447.
-

2.7.267 MANUAL-REQ-SPAN

Default Severity: Not Alarmed (NA), Non-Service-Affecting (NSA)

SONET Logical Object: EC1, OCN

DWDM Logical Objects: 2R, ESCON, FC, GE, ISC, TRUNK

The Manual Switch Request on Ring condition occurs on BLSRs when a user initiates a Manual Span command to move BLSR traffic from a working span to a protect span. This condition appears on the network view Alarms, Conditions, and History tabs. The port where the MANUAL SPAN command was applied is marked with an “M” on the network view detailed circuit map.

Clear the MANUAL-REQ-SPAN Condition

-
- Step 1** Complete the “[Clear a BLSR External Switching Command](#)” procedure on page 2-270.
- Step 2** If the condition does not clear, log into the Technical Support Website at <http://www.cisco.com/techsupport> for more information or call Cisco TAC 1 800 553-2447.
-

2.7.268 MAX-STATIONS

Default Severity: Major (MJ), Service-Affecting (SA)

SONET Logical Object: RPRIF

The Maximum IEEE 802.17b-based RPR Station Number Exceeded alarm can be raised by all ML card stations on a ring when the maximum quantity of stations, 255, is exceeded. This excess causes the IEEE 802.17b-based RPR scheme—and traffic—to break down.

IEEE 802.17b-based RPR messaging uses time-to-live (TTL), an 8-bit value. The maximum value these 8 bits (one byte) can have is 255. As a message travels (or hops) from station to station, the TTL is decremented by each station. Thus one station cannot communicate with another station more than 255 hops away.

If you are creating a large ring (more than 127 nodes), the MAX-STATIONS alarm might be raised until the ring is closed and stable.

MAX-STATIONS does not suppress any other alarms. However, this alarm is suppressed by the “[RPR-PASSTHR](#)” alarm on page 2-210.

Clear the MAX-STATIONS Alarm

-
- Step 1** Remove the extra stations from the ring to clear this alarm in all other stations and to restore traffic in the ring. For procedures to add or remove IEEE 802.17b-based RPR stations, refer to the *Cisco ONS 15454 and Cisco ONS 15454 SDH Ethernet Card Software Feature and Configuration Guide*.
- Step 2** If the alarm does not clear, log into the Technical Support Website at <http://www.cisco.com/techsupport> for more information or call Cisco TAC 1 800 553-2447 to report a Service-Affecting (SA) problem.
-

2.7.269 MEA (AIP)

Default Severity: Critical (CR), Service-Affecting (SA)

SONET Logical Object: AIP

If the Mismatch of Equipment Attributes (MEA) alarm is reported against the AIP, the fuse in the AIP board blew or is missing. The MEA alarm also occurs when an old AIP board with a 2-A fuse is installed in a newer ANSI 10-Gbps-compatible shelf assembly (15454-SA-ANSI or 15454-SA-HD).

Clear the MEA (AIP) Alarm

-
- Step 1** Complete the [“Replace the Alarm Interface Panel” procedure on page 2-282](#).
- Step 2** If the alarm does not clear, log into the Technical Support Website at <http://www.cisco.com/techsupport> for more information or call Cisco TAC 1 800 553-2447 in order to report a Service-Affecting (SA) problem.
-

2.7.270 MEA (BIC)

Default Severity: Critical (CR), Service-Affecting (SA)

SONET Logical Object: BIC

The Missing Equipment Attributes alarm for the backplane interface connector (BIC) indicates a compatibility issue in using high-density DS-3 cards with universal backplane interface connectors (UBIC) and an older shelf backplane. The backplane on the high-density shelf assembly, 15454-SA-HD, is compatible with the UBIC with horizontal connectors (UBIC-H) and UBIC with vertical connectors (UBIC-V) that the high-density EC-1, DS-1, and DS-3 electrical connections require. The MEA alarm is raised if you attempt to install a high-density card in Slot 4, 5, 6, 12, 13, or 14 in a shelf assembly with an older, incompatible backplane. The card is not usable in this case. It is also raised if you attempt to use an older BIC (also known as electrical interface assemblies [EIAs]) with the newer shelf assembly.

Clear the MEA (BIC) Alarm

- Step 1** Click the **Provisioning > Inventory** tabs to determine your backplane model. If the backplane is not a 15454-SA-HD, replace the backplane or do not attempt to use high-density DS-3 cards. [Table 2-18](#) lists the BICs that are compatible with various backplanes.

Table 2-18 BIC Compatibility Matrix

BIC Type	Part No.
BICs that work with the newer and older backplanes	MANUF_EQPT_ID_BIC_A_SMB_HD_BP
	MANUF_EQPT_ID_BIC_B_SMB_HD_BP
	MANUF_EQPT_ID_BIC_A_BNC_24_HD_BP
	MANUF_EQPT_ID_BIC_A_BNC_48_HD_BP
	MANUF_EQPT_ID_BIC_B_SMB
	MANUF_EQPT_ID_BIC_B_SMB_ALT
	MANUF_EQPT_ID_BIC_B_BNC_24
	MANUF_EQPT_ID_BIC_B_BNC_48
New HD BICs that work only with the new backplanes	MANUF_EQPT_ID_BIC_A_UNIV_VERT
	MANUF_EQPT_ID_BIC_B_UNIV_VERT
	MANUF_EQPT_ID_BIC_A_UNIV_HORIZ
	MANUF_EQPT_ID_BIC_B_UNIV_HORIZ
	MANUF_EQPT_ID_BIC_A_MINI_BNC_HD_BP
	MANUF_EQPT_ID_BIC_B_MINI_BNC_HD_BP
High-density BICs that work only with 15454-SA-HD	MANUF_EQPT_ID_BIC_A_SMB
	MANUF_EQPT_ID_BIC_A_SMB_ALT
	MANUF_EQPT_ID_BIC_A_BNC_24
	MANUF_EQPT_ID_BIC_A_BNC_48

- Step 2** If you determine that your BIC type and backplane are compatible despite the MEA alarm, or if the alarm does not clear after you resolve the incompatibilities, log into the Technical Support Website at <http://www.cisco.com/techsupport> for more information or call Cisco TAC 1 800 553-2447 in order to report a Service-Affecting (SA) problem.

2.7.271 MEA (EQPT)

Default Severity: Critical (CR), Service-Affecting (SA)

SONET Logical Object: EQPT

The MEA alarm for equipment is reported against a card slot when the physical card inserted into a slot does not match the card type that is provisioned for that slot in CTC. The alarm also occurs when certain cards introduced in Release 3.1 or later are inserted into an older shelf assembly or when older Ethernet cards (E1000-2 and E100T-12) are used in a newer 10-Gbps-compatible shelf assembly.

Removing the incompatible cards clears the alarm.

**Note**

For more information about Ethernet cards, refer to the *Cisco ONS 15454 and Cisco ONS 15454 SDH Ethernet Card Software Feature and Configuration Guide*.

**Note**

If an OC3-8 card is installed in Slot 5 to 6 and Slot 12 to 13, it does not appear in CTC and raises an MEA.

Clear the MEA (EQPT) Alarm

- Step 1** Physically verify the type of card that is installed in the slot reporting the MEA alarm. In node view, click the **Inventory** tab and compare it to the actual installed card.
- Step 2** Determine whether the ONS 15454 shelf assembly is a newer 10-Gbps-compatible shelf assembly (15454-SA-ANSI or 15454-SA-HD) or an earlier shelf assembly. Under the HW Part # column, if the part number is 800-19857-XX or 800-19856-XX, then you have a 15454-SA-ANSI shelf. If the part number is 800-24848-XX, then you have a 15454-SA-HD shelf. If the number is not one of those listed above, then you are using an earlier shelf assembly.

**Note**

On the 15454-SA-HD (P/N: 800-24848), 15454-SA-NEBS3E, 15454-SA-NEBS3, and 15454-SA-R1 (P/N: 800-07149) shelves, the AIP cover is clear plastic. On the 15454-SA-ANSI shelf (P/N: 800-19857), the AIP cover is metal.

- Step 3** Verify the type of card that sits in the slot reported in the object column of the MEA row on the Alarms window by reading the name at the top of the card faceplate.
- If you have a newer 10-Gbps-compatible shelf assembly (15454-SA-ANSI or 15454-SA-HD) and the card reporting the alarm is not an E1000-2 or E100T-12, proceed to [Step 4](#).
 - If you have a newer 10-Gbps-compatible shelf assembly (15454-SA-ANSI or 15454-SA-HD) and the card reporting the alarm is an E1000-2 or E100T-12, then that version of the Ethernet card is incompatible and must be removed. Proceed to [Step 4](#).

**Note**

The E1000-2-G and E100T-G cards are compatible with the newer ANSI 10-Gbps-compatible shelf assembly and are the functional equivalent of the older, noncompatible E1000-2 and E100T-12 cards. E1000-2-G and E100T-G cards can be used as replacements for E1000-2 and E100T-12 cards in a 10-Gbps-compatible shelf assembly.

- If you have an older shelf assembly and the card reporting the alarm is not a card introduced in Release 3.1 or later, which includes the OC-192, E1000-2-G, E100T-G, or OC-48 any slot (AS), proceed to [Step 4](#).
- If you have an older shelf assembly and the card reporting the alarm is a card introduced in Release 3.1 or later, which includes the OC-192, E1000-2-G, E100T-G, or OC-48 any slot (AS), the reporting card is incompatible with the shelf assembly and must be removed. Proceed to [Step 4](#).

Step 4 If you prefer the card type depicted by CTC, complete the “[Physically Replace a Traffic Card](#)” procedure on page 2-274 for the reporting card.

Step 5 If you prefer the card that physically occupies the slot but the card is not in service, does not have circuits mapped to it, and is not part of a protection group, place the cursor over the provisioned card in CTC and right-click to choose **Delete Card**.

The card that physically occupies the slot reboots, and CTC automatically provisions the card type into that slot.



Note If the card is in service, does have circuits mapped to it, is paired in a working protection scheme, has DCC communications turned on, or is used as a timing reference, CTC does not allow you to delete the card.

Step 6 If any ports on the card are in service, place them out of service (OOS,MT):



Caution Before placing ports out of service, ensure that live traffic is not present.

- a. Double-click the reporting card to open the card view.
- b. Click the **Provisioning** tab.
- c. Click the admin state of any in-service ports.
- d. Choose **OOS,MT** to take the ports out of service.

Step 7 If a circuit has been mapped to the card, complete the “[Delete a Circuit](#)” procedure on page 2-276.



Caution Before deleting the circuit, ensure that live traffic is not present.

Step 8 If the card is paired in a protection scheme, delete the protection group:

- a. Click the **Provisioning > Protection** tabs.
- b. Choose the protection group of the reporting card.
- c. Click **Delete**.

Step 9 Right-click the card reporting the alarm.

Step 10 Choose **Delete**.

The card that physically occupies the slot reboots, and CTC automatically provisions the card type into that slot.

Step 11 If the alarm does not clear, log into the Technical Support Website at <http://www.cisco.com/techsupport> for more information or call Cisco TAC 1 800 553-2447 in order to report a Service-Affecting (SA) problem.

2.7.272 MEA (FAN)

Default Severity: Critical (CR), Service-Affecting (SA)

SONET Logical Object: FAN

The MEA alarm is reported against the fan-tray assembly when a newer fan-tray assembly (15454-FTA3) with a 5-A fuse is used with an older shelf assembly or when an older fan-tray assembly with a 2-A fuse is used with a newer 10-Gbps-compatible shelf assembly (15454-SA-ANSI or 15454-SA-HD) that contains cards introduced in Release 3.1 or later. If a 10-Gbps-compatible shelf assembly contains only cards introduced before Release 3.1, then an older fan-tray assembly (15454-FTA-2) can be used and does not report an MEA alarm.

Clear the MEA (FAN) Alarm

-
- Step 1** Determine whether the shelf assembly is a newer 10-Gbps-compatible shelf assembly (15454-SA-ANSI or 15454-SA-HD) or an earlier shelf assembly. In node view, click the **Inventory** tab.
- Under the HW Part # column, if the part number is 800-19857-XX or 800-19856-XX, then you have a 15454-SA-ANSI shelf. If the part number is 800-24848-XX, you have a 15454-SA-HD shelf.
- Under the HW Part # column, if the number is not one of those listed above, then you are using an earlier shelf assembly.
- Step 2** If you have a 10-Gbps-compatible shelf assembly (15454-SA-ANSI or 15454-SA-HD), the alarm indicates that an older incompatible fan-tray assembly is installed in the shelf assembly. Obtain a newer fan-tray assembly (15454-FTA3) with a 5-A fuse and complete the [“Replace the Fan-Tray Assembly” procedure on page 2-281](#).
- Step 3** If you are using an earlier shelf assembly, the alarm indicates that you are using a newer fan-tray assembly (15454-FTA3), which is incompatible with the earlier version of the shelf assembly. Obtain an earlier version of the fan-tray assembly (15454-FTA2) and complete the [“Replace the Fan-Tray Assembly” procedure on page 2-281](#).
- Step 4** If the alarm does not clear, log into the Technical Support Website at <http://www.cisco.com/techsupport> for more information or call Cisco TAC 1 800 553-2447 in order to report a Service-Affecting (SA) problem.
-

2.7.273 MEA (PPM)

For information about this alarm or condition, refer to the “Alarm Troubleshooting” chapter in the *Cisco ONS 15454 DWDM Troubleshooting Guide*. This guide discusses all DWDM alarms.

2.7.274 MEA (SHELF)

For information about this alarm or condition, refer to the “Alarm Troubleshooting” chapter in the *Cisco ONS 15454 DWDM Troubleshooting Guide*. This guide discusses all DWDM alarms.

2.7.275 MEM-GONE

Default Severity: Major (MJ), Service-Affecting (SA)

SONET Logical Object: EQPT

The Memory Gone alarm occurs when data generated by software operations exceeds the memory capacity of the TCC2/TCC2P. The TCC2/TCC2P cards which exceed the memory capacity reboot to avoid failure of card operations.

**Note**

The alarm does not require user intervention. The MEM-LOW alarm always precedes the MEM-GONE alarm.

2.7.276 MEM-LOW

Default Severity: Minor (MN), Non-Service-Affecting (NSA)

SONET Logical Object: EQPT

The Free Memory of Card Almost Gone alarm occurs when data generated by software operations is close to exceeding the memory capacity of the TCC2/TCC2P. The alarm clears when additional memory becomes available. If additional memory is not made available and the memory capacity of the card is exceeded, CTC ceases to function.

**Note**

The alarm does not require user intervention. If the alarm does not clear, log into the Technical Support Website at <http://www.cisco.com/techsupport> for more information or call Cisco TAC 1 800 553-2447.

2.7.277 MFGMEM

Default Severity: Critical (CR), Service-Affecting (SA)

SONET Logical Objects: AICI-AEP, AICI-AIE, AIP, BPLANE, FAN

DWDM Logical Object: PPM

The Manufacturing Data Memory Failure alarm occurs when the EEPROM fails on a card or component, or when the TCC2/TCC2P cannot read this memory. EEPROM stores manufacturing data that a system TCC2/TCC2P uses to determine system compatibility and shelf inventory status. Unavailability of this information can cause less-significant problems. The AIP EEPROM also stores the system MAC address. If the MFGMEM alarm indicates EEPROM failure on these panels, IP connectivity could be disrupted and the system icon is grayed out in CTC network view.

**Tip**

When you lose LAN connectivity with an ONS 15454 due to an MFGMEM alarm on the AIP, you can reestablish node management by disconnecting the Ethernet cable from the panel and connecting it to the active TCC2/TCC2P LAN port.

Clear the MFGMEM Alarm

Step 1 Complete the [“Reset an Active TCC2/TCC2P Card and Activate the Standby Card”](#) procedure on page 2-271.

Wait ten minutes to verify that the card you reset completely reboots and becomes the standby card.

- Step 2** If the reset card has not rebooted successfully, or the alarm has not cleared, call Cisco TAC 1 800 553-2447. If the Cisco TAC technician tells you to reseat the card, complete the “[Remove and Reinsert \(Reseat\) the Standby TCC2/TCC2P Card](#)” procedure on page 2-273. If the Cisco TAC technician tells you to remove the card and reinstall a new one, complete the “[Physically Replace a Traffic Card](#)” procedure on page 2-274.
- Step 3** If the MFGMEM alarm continues to report after replacing the TCC2/TCC2Ps, the problem lies with the EEPROM.
- Step 4** If the MFGMEM is reported from the fan-tray assembly, obtain a fan-tray assembly and complete the “[Replace the Fan-Tray Assembly](#)” procedure on page 2-281.
- Step 5** If the MFGMEM is reported from the AIP, the backplane, or the alarm persists after the fan-tray assembly is replaced, log into the Technical Support Website at <http://www.cisco.com/techsupport> for more information or call Cisco TAC 1 800 553-2447 to report a Service-Affecting (SA) problem.
-

2.7.278 MS-DEG

The MS-DEG condition is not used in this platform in this release. It is reserved for development.

2.7.279 MS-EXC

The MS-EXC condition is not used in this platform in this release. It is reserved for development.

2.7.280 MT-OCHNC

For information about this alarm or condition, refer to the “Alarm Troubleshooting” chapter in the *Cisco ONS 15454 DWDM Troubleshooting Guide*. This guide discusses all DWDM alarms.

2.7.281 NO-CONFIG

Default Severity: Not Alarmed (NA), Non-Service-Affecting (NSA)

SONET Logical Object: EQPT

The No Startup Configuration condition applies to ML-Series Ethernet cards and occurs when no startup configuration file has been downloaded to the TCC2/TCC2P, whether or not you preprovision the card slot. This alarm can be expected during provisioning. When the startup configuration file is copied to the active TCC2/TCC2P, the alarm clears.



Note

For more information about the ML-Series Ethernet cards, refer to the *Cisco ONS 15454 and Cisco ONS 15454 SDH Ethernet Card Software Feature and Configuration Guide*.

Clear the NO-CONFIG Condition

- Step 1** Create a startup configuration for the card in Cisco IOS.

Follow the card provisioning instructions in the *Cisco ONS 15454 and Cisco ONS 15454 SDH Ethernet Card Software Feature and Configuration Guide*.

- Step 2** Upload the configuration file to the TCC2/TCC2P:
- In node view, right-click the ML-Series card graphic.
 - Choose **IOS Startup Config** from the shortcut menu.
 - Click **Local > TCC** and navigate to the file location.
- Step 3** Complete the “[Reset a Traffic Card in CTC](#)” procedure on page 2-271.
- Step 4** If the condition does not clear, log into the Technical Support Website at <http://www.cisco.com/techsupport> for more information or call Cisco TAC 1 800 553-2447.
-

2.7.282 NON-CISCO-PPM

Default Severity: Minor (MN), Non-Service-Affecting (NSA)

SONET Logical Object: PPM

The Non-Cisco PPM Inserted condition occurs when a PPM that is plugged into a card’s port fails the security code check. The check fails when the PPM used is not a Cisco PPM.

Clear the NON-CISCO-PPM Condition

- Step 1** Obtain the correct Cisco PPM and replace the existing PPM with the new one.
- Step 2** If the condition does not clear, log into the Technical Support Website at <http://www.cisco.com/techsupport> for more information or call Cisco TAC 1 800 553-2447.
-

2.7.283 NOT-AUTHENTICATED

Default Severity: Minor (MN), Non-Service-Affecting (NSA)

SONET Logical Object: SYSTEM

The NOT-AUTHENTICATED alarm is raised by CTC (not by the NE) when CTC fails to log into a node. This alarm only appears in CTC where the login failure occurred. This alarm differs from the “[INTRUSION-PSWD](#)” alarm on page 2-132 because INTRUSION-PSWD occurs when a user exceeds the login failures threshold.



Note

NOT-AUTHENTICATED is an informational alarm and is resolved when CTC successfully logs into the node.

2.7.284 OCHNC-INC

For information about this alarm or condition, refer to the “Alarm Troubleshooting” chapter in the *Cisco ONS 15454 DWDM Troubleshooting Guide*. This guide discusses all DWDM alarms.

2.7.285 OCHTERM-INC

For information about this alarm or condition, refer to the “Alarm Troubleshooting” chapter in the *Cisco ONS 15454 DWDM Troubleshooting Guide*. This guide discusses all DWDM alarms.

2.7.286 ODUK-1-AIS-PM

For information about this alarm or condition, refer to the “Alarm Troubleshooting” chapter in the *Cisco ONS 15454 DWDM Troubleshooting Guide*. This guide discusses all DWDM alarms.

2.7.287 ODUK-2-AIS-PM

For information about this alarm or condition, refer to the “Alarm Troubleshooting” chapter in the *Cisco ONS 15454 DWDM Troubleshooting Guide*. This guide discusses all DWDM alarms.

2.7.288 ODUK-3-AIS-PM

For information about this alarm or condition, refer to the “Alarm Troubleshooting” chapter in the *Cisco ONS 15454 DWDM Troubleshooting Guide*. This guide discusses all DWDM alarms.

2.7.289 ODUK-4-AIS-PM

For information about this alarm or condition, refer to the “Alarm Troubleshooting” chapter in the *Cisco ONS 15454 DWDM Troubleshooting Guide*. This guide discusses all DWDM alarms.

2.7.290 ODUK-AIS-PM

For information about this alarm or condition, refer to the “Alarm Troubleshooting” chapter in the *Cisco ONS 15454 DWDM Troubleshooting Guide*. This guide discusses all DWDM alarms.

2.7.291 ODUK-BDI-PM

For information about this alarm or condition, refer to the “Alarm Troubleshooting” chapter in the *Cisco ONS 15454 DWDM Troubleshooting Guide*. This guide discusses all DWDM alarms.

2.7.292 ODUK-LCK-PM

For information about this alarm or condition, refer to the “Alarm Troubleshooting” chapter in the *Cisco ONS 15454 DWDM Troubleshooting Guide*. This guide discusses all DWDM alarms.

2.7.293 ODUK-OCI-PM

For information about this alarm or condition, refer to the “Alarm Troubleshooting” chapter in the *Cisco ONS 15454 DWDM Troubleshooting Guide*. This guide discusses all DWDM alarms.

2.7.294 ODUK-SD-PM

For information about this alarm or condition, refer to the “Alarm Troubleshooting” chapter in the *Cisco ONS 15454 DWDM Troubleshooting Guide*. This guide discusses all DWDM alarms.

2.7.295 ODUK-SF-PM

For information about this alarm or condition, refer to the “Alarm Troubleshooting” chapter in the *Cisco ONS 15454 DWDM Troubleshooting Guide*. This guide discusses all DWDM alarms.

2.7.296 ODUK-TIM-PM

For information about this alarm or condition, refer to the “Alarm Troubleshooting” chapter in the *Cisco ONS 15454 DWDM Troubleshooting Guide*. This guide discusses all DWDM alarms.

2.7.297 OOU-TPT

Default Severity: Not Alarmed (NA), Non-Service-Affecting (NSA)

SONET Logical Objects: STSTRM, VT-TERM

The Out of Use Transport Failure alarm is a VCAT member alarm. (VCAT member circuits are independent circuits that are concatenated from different time slots into a higher-rate signal.) This condition is raised when a member circuit in a VCAT is unused, such as when it is removed by SW-LCAS. It occurs in conjunction with the [“VCG-DEG” condition on page 2-256](#).

Clear the OOT-TPT Condition

-
- Step 1** Complete the [“Clear the VCG-DEG Condition” procedure on page 2-256](#). Clearing that condition clears this condition as well.
- Step 2** If the condition does not clear, log into the Technical Support Website at <http://www.cisco.com/techsupport> for more information or call Cisco TAC 1 800 553-2447.
-

2.7.298 OPEN-SLOT

Default Severity: Not Alarmed (NA)

Logical Object: EQPT

The Open Slot condition indicates that there is an open slot in the system shelf. Slot covers assist with airflow and cooling.

Clear the OPEN-SLOT Condition

-
- Step 1** To install a slot cover and clear this condition, refer to the procedures located in the “Install Cards and Fiber-Optic Cable” chapter of the *Cisco ONS 15454 Procedure Guide*.
- Step 2** If the condition does not clear, log into the Technical Support Website at <http://www.cisco.com/techsupport> for more information or call Cisco TAC 1 800 553-2447.
-

2.7.299 OPTNTWMIS

For information about this alarm or condition, refer to the “Alarm Troubleshooting” chapter in the *Cisco ONS 15454 DWDM Troubleshooting Guide*. This guide discusses all DWDM alarms.

2.7.300 OPWR-HDEG

For information about this alarm or condition, refer to the “Alarm Troubleshooting” chapter in the *Cisco ONS 15454 DWDM Troubleshooting Guide*. This guide discusses all DWDM alarms.

2.7.301 OPWR-HFAIL

For information about this alarm or condition, refer to the “Alarm Troubleshooting” chapter in the *Cisco ONS 15454 DWDM Troubleshooting Guide*. This guide discusses all DWDM alarms.

2.7.302 OPWR-LDEG

For information about this alarm or condition, refer to the “Alarm Troubleshooting” chapter in the *Cisco ONS 15454 DWDM Troubleshooting Guide*. This guide discusses all DWDM alarms.

2.7.303 OPWR-LFAIL

For information about this alarm or condition, refer to the “Alarm Troubleshooting” chapter in the *Cisco ONS 15454 DWDM Troubleshooting Guide*. This guide discusses all DWDM alarms.

2.7.304 OSRION

For information about this alarm or condition, refer to the “Alarm Troubleshooting” chapter in the *Cisco ONS 15454 DWDM Troubleshooting Guide*. This guide discusses all DWDM alarms.

2.7.305 OTUK-AIS

For information about this alarm or condition, refer to the “Alarm Troubleshooting” chapter in the *Cisco ONS 15454 DWDM Troubleshooting Guide*. This guide discusses all DWDM alarms.

2.7.306 OTUK-BDI

For information about this alarm or condition, refer to the “Alarm Troubleshooting” chapter in the *Cisco ONS 15454 DWDM Troubleshooting Guide*. This guide discusses all DWDM alarms.

2.7.307 OTUK-IAE

For information about this alarm or condition, refer to the “Alarm Troubleshooting” chapter in the *Cisco ONS 15454 DWDM Troubleshooting Guide*. This guide discusses all DWDM alarms.

2.7.308 OTUK-LOF

For information about this alarm or condition, refer to the “Alarm Troubleshooting” chapter in the *Cisco ONS 15454 DWDM Troubleshooting Guide*. This guide discusses all DWDM alarms.

2.7.309 OTUK-SD

For information about this alarm or condition, refer to the “Alarm Troubleshooting” chapter in the *Cisco ONS 15454 DWDM Troubleshooting Guide*. This guide discusses all DWDM alarms.

2.7.310 OTUK-SF

For information about this alarm or condition, refer to the “Alarm Troubleshooting” chapter in the *Cisco ONS 15454 DWDM Troubleshooting Guide*. This guide discusses all DWDM alarms.

2.7.311 OTUK-TIM

For information about this alarm or condition, refer to the “Alarm Troubleshooting” chapter in the *Cisco ONS 15454 DWDM Troubleshooting Guide*. This guide discusses all DWDM alarms.

2.7.312 OUT-OF-SYNC

For information about this alarm or condition, refer to the “Alarm Troubleshooting” chapter in the *Cisco ONS 15454 DWDM Troubleshooting Guide*. This guide discusses all DWDM alarms.

2.7.313 PARAM-MISM

For information about this alarm or condition, refer to the “Alarm Troubleshooting” chapter in the *Cisco ONS 15454 DWDM Troubleshooting Guide*. This guide discusses all DWDM alarms.

2.7.314 PDI-P

Default Severity: Not Alarmed (NA), Non-Service-Affecting (NSA)

SONET Logical Objects: STSMON, STSTRM

PDI-P is a set of application-specific codes indicating a signal label mismatch failure (SLMF) in the ONS 15454 STS path overhead. The condition indicates to downstream equipment that there is a defect in one or more of the directly mapped payloads contained in that STS synchronous payload envelope (SPE). For example, the mismatch could occur in the overhead to the path selector in a downstream node configured as part of a UPSR. The PDI-P codes appear in the STS Signal Label (C2 byte).

An SLMF often occurs when the payload (for example, ATM) does not match what the signal label is reporting. The “AIS” condition on page 2-37 often accompanies a PDI-P condition. If the PDI-P is the only condition reported with the AIS, clearing PDI-P clears the AIS. PDI-P can also occur during an upgrade, but usually clears itself and is not a valid condition.

A PDI-P condition reported on an OC-N port supporting a G1000-4 card circuit could result from the end-to-end Ethernet link integrity feature of the G1000-4 card. If the link integrity is the cause of the path defect, it is typically accompanied by the “TPTFAIL (G1000)” alarm on page 2-249 or the “CARLOSS (G1000)” alarm on page 2-63 reported against one or both Ethernet ports terminating the circuit. If this is the case, clear the TPTFAIL and CARLOSS alarms to resolve the PDI-P condition.

A PDI-P condition reported on an OC-N port supporting an ML-Series card circuit could result from the end-to-end Ethernet link integrity feature of the ML-Series card. If the link integrity is the cause, it is typically accompanied by the “TPTFAIL (ML100T, ML1000, MLFX)” alarm on page 2-250 reported against one or both POS ports terminating the circuit. If TPTFAIL is reported against one or both of the POS ports, troubleshooting the accompanying alarm clears the PDI-P condition. Refer to the *Cisco ONS 15454 and Cisco ONS 15454 SDH Ethernet Card Software Feature and Configuration Guide* for more information about ML-Series cards.



Warning

On the OC-192 card, the laser is on when the card is booted and the safety key is in the on position (labeled 1). The port does not have to be in service for the laser to be on. The laser is off when the safety key is off (labeled 0). Statement 293



Warning

Invisible laser radiation could be emitted from the end of the unterminated fiber cable or connector. Do not stare into the beam directly with optical instruments. Viewing the laser output with certain optical instruments (for example, eye loupes, magnifiers, and microscopes) within a distance of 100 mm could pose an eye hazard. Statement 1056



Warning

Use of controls, adjustments, or performing procedures other than those specified could result in hazardous radiation exposure. Statement 1057

**Note**

For more information about Ethernet cards, refer to the *Cisco ONS 15454 and Cisco ONS 15454 SDH Ethernet Card Software Feature and Configuration Guide*.

Clear the PDI-P Condition

- Step 1** Verify that all circuits terminating in the reporting card are DISCOVERED:
- Click the **Circuits** tab.
 - Verify that the **Status** column lists the circuit as active.
 - If the Status column lists the circuit as PARTIAL, wait 10 minutes for the ONS 15454 to initialize fully. If the PARTIAL status does not change after full initialization, log into the Technical Support Website at <http://www.cisco.com/techsupport> for more information or call Cisco TAC to report a Service-Affecting (SA) problem 1 800 553-2447.

- Step 2** After determining that the circuit is DISCOVERED, ensure that the signal source to the card reporting the alarm is working.

**Caution**

Always use the supplied electrostatic discharge wristband when working with a powered ONS 15454. Plug the wristband cable into the ESD jack located on the lower-right edge of the shelf assembly.

- Step 3** If traffic is affected, complete the [“Delete a Circuit” procedure on page 2-276](#).

**Caution**

Deleting a circuit can affect existing traffic.

- Step 4** Recreate the circuit with the correct circuit size. Refer to the “Create Circuits and VT Tunnels” chapter in the *Cisco ONS 15454 Procedure Guide* for detailed procedures to create circuits.
- Step 5** If circuit deletion and re-creation does not clear the condition, verify that there is no problem stemming from the far-end OC-N card providing STS payload to the reporting card.
- Step 6** If the condition does not clear, confirm the cross-connect between the OC-N card and the reporting card.
- Step 7** If the condition does not clear, clean the far-end optical fiber according to site practice. If no site practice exists, complete the procedure in the “Maintain the Node” chapter of the *Cisco ONS 15454 Procedure Guide*.
- Step 8** If the condition does not clear, complete the [“Physically Replace a Traffic Card” procedure on page 2-274](#) for the optical/electrical cards.
- Step 9** If the condition does not clear, log into the Technical Support Website at <http://www.cisco.com/techsupport> for more information or call Cisco TAC 1 800 553-2447.

2.7.315 PEER-NORESPONSE

Default Severity: Major (MJ), Non-Service-Affecting (NSA)

SONET Logical Object: EQPT

The switch agent raises a Peer Card Not Responding alarm if either traffic card in a protection group does not receive a response to the peer status request message. PEER-NORESPONSE is a software failure and occurs at the task level, as opposed to a communication failure, which is a hardware failure between peer cards.

Clear the PEER-NORESPONSE Alarm

-
- Step 1** Complete the “[Reset a Traffic Card in CTC](#)” procedure on page 2-271 for the reporting card. For the LED behavior, see the “[2.8.2 Typical Traffic Card LED Activity During Reset](#)” section on page 2-260.
- Step 2** Verify that the reset is complete and error-free and that no new related alarms appear in CTC. Verify the LED appearance: A green ACT/SBY LED indicates an active card. An amber ACT/SBY LED indicates a standby card.
- Step 3** If the alarm does not clear, log into the Technical Support Website at <http://www.cisco.com/techsupport> for more information or call Cisco TAC 1 800 553-2447 to report a service-affecting (SA) problem.
-

2.7.316 PLM-P

Default Severity: Critical (CR), Service-Affecting (SA)

SONET Logical Objects: STSMON, STSTRM

A Payload Label Mismatch Path alarm indicates that signal does not match its label. The condition is indicated by a problematic C2 byte value in the SONET path overhead. The alarm is raised if all of the following conditions are met:

- The received C2 byte is not 0x00 (unequipped).
- The received C2 byte is not a PDI value.
- The received C2 does not match the expected C2.
- The expected C2 byte is not 0x01 (equipped, unspecified).
- The received C2 byte is not 0x01 (equipped, unspecified).

For example, on nodes equipped with CTC Software R4.1 and earlier, this alarm could occur when you have a DS3XM-6 card connected to a DS-3 card instead of a DS-1 card. The DS3XM-6 card expects a C2 label byte value of 01. A DS-1 card transmits this value, but a DS-3 card transmits a value of 04. The mismatch between the sent and expected values causes the PLM-P alarm.



Warning

On the OC-192 card, the laser is on when the card is booted and the safety key is in the on position (labeled 1). The port does not have to be in service for the laser to be on. The laser is off when the safety key is off (labeled 0). Statement 293.



Warning

Invisible laser radiation could be emitted from the end of the unterminated fiber cable or connector. Do not stare into the beam directly with optical instruments. Viewing the laser output with certain optical instruments (for example, eye loupes, magnifiers, and microscopes) within a distance of 100 mm could pose an eye hazard. Statement 1056

**Warning**

Use of controls, adjustments, or performing procedures other than those specified could result in hazardous radiation exposure. Statement 1057

Clear the PLM-P Alarm

Step 1 Complete the [“Clear the PDI-P Condition” procedure on page 2-195](#).

**Caution**

Always use the supplied electrostatic discharge wristband when working with a powered ONS 15454. Plug the wristband cable into the ESD jack located on the lower-right edge of the shelf assembly.

Step 2 If the alarm does not clear, log into the Technical Support Website at <http://www.cisco.com/techsupport> for more information or call Cisco TAC 1 800 553-2447 in order to report a Service-Affecting (SA) problem.

2.7.317 PLM-V

Default Severity: Major (MJ), Service-Affecting (SA)

SONET Logical Object: VT-TERM, VT-MON

A Payload Label Mismatch VT Layer alarm indicates that the content of the V5 byte in the SONET overhead is inconsistent or invalid. PLM-V occurs when ONS 15454s interoperate with equipment that performs bit-synchronous mapping for DS-1 signal. The ONS 15454 uses asynchronous mapping.

Clear the PLM-V Alarm

Step 1 Verify that your signal source matches the signal allowed by the traffic card. For example, the traffic card does not allow VT6 or VT9 mapping.

Step 2 If the signal source matches the card, verify that the SONET VT path originator is sending the correct VT label value. You can find the SONET VT path originator using circuit provisioning steps.

Step 3 If the alarm does not clear, log into the Technical Support Website at <http://www.cisco.com/techsupport> for more information or call Cisco TAC 1 800 553-2447 in order to report a Service-Affecting (SA) problem.

2.7.318 PMI

For more information about the PMI condition, refer to the “Alarm Troubleshooting” chapter in the *Cisco ONS 15454 DWDM Troubleshooting Guide*.

2.7.319 PORT-FAIL

For more information about the PORT-FAIL alarm, refer to the “Alarm Troubleshooting” chapter in the *Cisco ONS 15454 DWDM Troubleshooting Guide*.

2.7.320 PORT-MISMATCH

Default Severity: Major (MJ), Service-Affecting (SA)

SONET Logical Objects: CE-MR-10, ML-MR-10, FC_MR-4

The Pluggable PORT-MISMATCH alarm applies to FC_MR-4, ML-MR-10, and CE-MR-10 Ethernet cards.

For the ML-MR-10 and CE-MR-10 cards the alarm indicates either of the following:

- The provisioned payload, speed, or duplex configured on the port does not match that of the SFP plugged into the port.
- A non-supported SFP is plugged into the port.

For the FC_MR-4 card the alarm indicates that a non-supported GBIC is plugged into the port.

Clear the PORT-MISMATCH Alarm

To clear the alarm on the CE-MR-10 card, either plug-in a supported SFP into the CE-MR-10 port or follow these steps to provision the correct payload, speed, or duplex:

1. In node view (single-shelf mode) or shelf view (multishelf mode), double-click the CE-MR-10 card to open the card view.
2. Click the **Provisioning > Ether Ports** tabs.
3. Specify correct values in the Expected Speed and Expected Duplex fields to match the SFP configuration.
4. Click **Apply**.

To clear the alarm on the FC_MR-4 card, plug-in a supported GBIC into the FC_MR-4 port and follow these steps to provision the media type:

1. In node view (single-shelf mode) or shelf view (multishelf mode), double-click the FC_MR-4 card graphic to open the card.
2. Click the **Provisioning > Port > General** tabs.
3. Specify proper payload value in the Media Type field.
4. Click **Apply**.

For the CE-MR-10 and FC_MR-10 card, the alarm can also be cleared using TL1 commands. For detailed instructions, refer to the *Cisco ONS 15454*, *Cisco ONS 15600*, and *Cisco ONS 15310-MA SONET TL1 Command Guide*.

For the ML-MR-10 card, the alarm can be cleared through Cisco IOS commands. For detailed instructions, refer to the *Cisco ONS 15454* and *Cisco ONS 15454 SDH Ethernet Card Software Feature and Configuration Guide*.

If the alarm does not clear, log into the Cisco Technical Support Website at <http://www.cisco.com/techsupport> for more information or call Cisco TAC (1 800 553-2447) to report a Service-Affecting (SA) problem.

2.7.321 PRC-DUPID

Default Severity: Major (MJ), Service-Affecting (SA)

SONET Logical Object: OCN

The Procedural Error Duplicate Node ID alarm indicates that two identical node IDs exist in the same ring. The ONS 15454 requires each node in the ring to have a unique node ID.

Clear the PRC-DUPID Alarm

-
- Step 1** Log into a node on the ring.
 - Step 2** Find the node ID by completing the [“Identify a BLSR Ring Name or Node ID Number” procedure on page 2-261](#).
 - Step 3** Repeat [Step 2](#) for all the nodes on the ring.
 - Step 4** If two nodes have an identical node ID number, complete the [“Change a BLSR Node ID Number” procedure on page 2-262](#) so that each node ID is unique.
 - Step 5** If the alarm does not clear, log into the Technical Support Website at <http://www.cisco.com/techsupport> for more information or call Cisco TAC 1 800 553-2447 in order to report a Service-Affecting (SA) problem.
-

2.7.322 PROTNA

Default Severity: Minor (MN), Non-Service-Affecting (NSA)

SONET Logical Object: EQPT

The Protection Unit Not Available alarm is caused by an OOS protection card when a TCC2/TCC2P or XC10G card that has been provisioned as part of a protection group is not available. Unavailable protection can occur when a card is reset, but the alarm clears as soon as the card is back in service. The alarm clears if the device or facility is brought back in service.

Clear the PROTNA Alarm

-
- Step 1** If the PROTNA alarm occurs and does not clear, and if it is raised against a controller or cross-connect card, ensure that there is a redundant TCC2/TCC2P installed and provisioned in the chassis.
 - Step 2** If the alarm is raised against a line card, verify that the ports have been taken out of service (OOS,MT):
 - a. In CTC, double-click the reporting card to open the card view (if the card is not an XC10G card).
 - b. Click the **Provisioning** tab.
 - c. Click the admin state of any in-service (IS) ports.

- d. Choose **OOS,MT** to take the ports out of service.
- Step 3** Complete the “[Reset a Traffic Card in CTC](#)” procedure on page 2-271 for the reporting card. For the LED behavior, see the “[2.8.2 Typical Traffic Card LED Activity During Reset](#)” section on page 2-260.
- Step 4** Verify that the reset is complete and error-free and that no new related alarms appear in CTC. Verify the LED appearance: A green ACT/SBY LED indicates an active card. An amber ACT/SBY LED indicates a standby card.
- Step 5** If the alarm does not clear, complete the “[Remove and Reinsert \(Reseat\) Any Card](#)” procedure on page 2-274 for the reporting card.
- Step 6** If the alarm does not clear, log into the Technical Support Website at <http://www.cisco.com/techsupport> for more information or call Cisco TAC 1 800 553-2447.

2.7.323 PROV-MISMATCH

For information about this alarm or condition, refer to the “Alarm Troubleshooting” chapter in the *Cisco ONS 15454 DWDM Troubleshooting Guide*. This guide discusses all DWDM alarms.

2.7.324 PTIM

For information about this alarm or condition, refer to the “Alarm Troubleshooting” chapter in the *Cisco ONS 15454 DWDM Troubleshooting Guide*. This guide discusses all DWDM alarms.

2.7.325 PWR-FAIL-A

Default Severity: Minor (MN), Non-Service-Affecting (NSA)

SONETLogical Object: EQPT

The Equipment Power Failure at Connector A alarm occurs when there is no power supply from the main power connector to the equipment. This alarm occurs on the electrical interface assemblies (EIA), 15454_MRC-12 Multirate card, MRC-2.5G-4 Multirate card, OC192SR1/STM64IO Short Reach and OC192/STM64 Any Reach cards (also known as OC192-XFP in CTC), OC12 IR/STM4 SH 1310-4 card, OC3 IR/STM1 SH 1310-8 card or TCC2/TCC2P.



Warning

The power supply circuitry for the equipment can constitute an energy hazard. Before you install or replace the equipment, remove all jewelry (including rings, necklaces, and watches). Metal objects can come into contact with exposed power supply wiring or circuitry inside the DSLAM equipment. This could cause the metal objects to heat up and cause serious burns or weld the metal object to the equipment. Statement 207

Clear the PWR-FAIL-A Alarm

- Step 1** If a single card has reported the alarm, take the following actions depending on the reporting card:
- If the reporting card is an active traffic line port in a 1+1 protection group or part of a UPSR, ensure that an APS traffic switch has occurred to move traffic to the protect port.



Note Removing a card that currently carries traffic on one or more ports can cause a traffic hit. To avoid this, perform an external switch if a switch has not already occurred. See the “[2.9.2 Protection Switching, Lock Initiation, and Clearing](#)” section on page 2-262 for commonly used traffic-switching procedures.

- If the alarm is reported against a TCC2/TCC2P, complete the “[Reset an Active TCC2/TCC2P Card and Activate the Standby Card](#)” procedure on page 2-271.
- If the alarm is reported against an OC-N card, complete the “[Reset a Traffic Card in CTC](#)” procedure on page 2-271.
- If the alarm is reported against a cross-connect card, complete the “[Reset a Traffic Card in CTC](#)” procedure on page 2-271 for the cross-connect card. (The process is similar.)

- Step 2** If the alarm does not clear, complete the “[Remove and Reinsert \(Reseat\) Any Card](#)” procedure on page 2-274.
- Step 3** If the alarm does not clear, complete the “[Physically Replace a Traffic Card](#)” procedure on page 2-274 for the reporting card.
- Step 4** If the single card replacement does not clear the alarm, or if multiple cards report the alarm, verify the office power. Refer to the “Install the Shelf and Backplane Cable” chapter in the *Cisco ONS 15454 Procedure Guide* for procedures. See the “[1.13 Power Supply Problems](#)” section on page 1-147 as necessary.
- Step 5** If the alarm does not clear, reseal the power cable connection to the connector.
- Step 6** If the alarm does not clear, physically replace the power cable connection to the connector.
- Step 7** If the alarm does not clear, log into the Technical Support Website at <http://www.cisco.com/techsupport> for more information or call Cisco TAC 1 800 553-2447.

2.7.326 PWR-FAIL-B

Default Severity: Minor (MN), Non-Service-Affecting (NSA)

SONET Logical Object: EQPT

The Equipment Power Failure at Connector B alarm occurs when there is no power supply from the main power connector to the equipment. This alarm occurs on the electrical interface assemblies (EIA), 15454_MRC-12 Multirate card, MRC-2.5G-4 Multirate card, OC192SR1/STM64IO Short Reach and OC192/STM64 Any Reach cards (also known as OC192-XFP in CTC), OC12 IR/STM4 SH 1310-4 card, OC3 IR/STM1 SH 1310-8 card or TCC2/TCC2P.



Warning

The power supply circuitry for the equipment can constitute an energy hazard. Before you install or replace the equipment, remove all jewelry (including rings, necklaces, and watches). Metal objects can come into contact with exposed power supply wiring or circuitry inside the DSLAM equipment. This could cause the metal objects to heat up and cause serious burns or weld the metal object to the equipment. Statement 207

Clear the PWR-FAIL-B Alarm

-
- Step 1** Complete the “[Clear the PWR-FAIL-A Alarm](#)” procedure on page 2-200.
- Step 2** If the alarm does not clear, log into the Technical Support Website at <http://www.cisco.com/techsupport> for more information or call Cisco TAC 1 800 553-2447.
-

2.7.327 PWR-FAIL-RET-A

Default Severity: Minor (MN), Non-Service-Affecting (NSA)

SONET Logical Object: EQPT

The Equipment Power Failure at Connector A alarm occurs when there is no power supplied to the backup power connector on the shelf. This alarm occurs on the electrical interface assemblies (EIA), 15454_MRC-12 Multirate card, MRC-2.5G-4 Multirate card, OC192SR1/STM64IO Short Reach and OC192/STM64 Any Reach cards (also known as OC192-XFP in CTC), OC12 IR/STM4 SH 1310-4 card, OC3 IR/STM1 SH 1310-8 card or TCC2/TCC2P.

Clear the PWR-FAIL-RET-A Alarm

-
- Step 1** Complete the “[Clear the PWR-FAIL-A Alarm](#)” procedure on page 2-200.
- Step 2** If the alarm does not clear, log into the Technical Support Website at <http://www.cisco.com/techsupport> for more information or call Cisco TAC 1 800 553-2447.
-

2.7.328 PWR-FAIL-RET-B

Default Severity: Minor (MN), Non-Service-Affecting (NSA)

SONET Logical Object: EQPT

The Equipment Power Failure at Connector B alarm occurs when there is no power supplied to the backup power connector on the shelf. This alarm occurs on the electrical interface assemblies (EIA), 15454_MRC-12 Multirate card, MRC-2.5G-4 Multirate card, OC192SR1/STM64IO Short Reach and OC192/STM64 Any Reach cards (also known as OC192-XFP in CTC), OC12 IR/STM4 SH 1310-4 card, OC3 IR/STM1 SH 1310-8 card or TCC2/TCC2P.

Clear the PWR-FAIL-RET-A Alarm

-
- Step 1** Complete the “[Clear the PWR-FAIL-A Alarm](#)” procedure on page 2-200.
- Step 2** If the alarm does not clear, log into the Technical Support Website at <http://www.cisco.com/techsupport> for more information or call Cisco TAC 1 800 553-2447.
-

2.7.329 RAI

Default Severity: Not Alarmed (NA), Non-Service-Affecting (NSA)

SONET Logical Objects: DS1, DS3, E1

The Remote Alarm Indication condition signifies an end-to-end failure. The error condition is sent from one end of the SONET path to the other. RAI on a DS3XM-6 card indicates that the far-end node is receiving a DS-3 AIS.

Clear the RAI Condition

-
- Step 1** Complete the “[Clear the AIS Condition](#)” procedure on page 2-37.
- Step 2** If the condition does not clear, log into the Technical Support Website at <http://www.cisco.com/techsupport> for more information or call Cisco TAC 1 800 553-2447.
-

2.7.330 RCVR-MISS

Default Severity: Major (MJ), Service-Affecting (SA)

SONET Logical Objects: DS1, E1

A Facility Termination Equipment Receiver Missing alarm occurs when the facility termination equipment detects an incorrect amount of impedance on its backplane connector. Incorrect impedance usually occurs when a receive cable is missing from a DS-1 port, or a possible mismatch of backplane equipment occurs. For example, an SMB connector or a BNC connector could be misconnected to a DS-1 card.

**Note**

DS-1s are four-wire circuits and need a positive (tip) and negative (ring) connection for both transmit and receive.

Clear the RCVR-MISS Alarm

-
- Step 1** Ensure that the device attached to the DS-1 port is operational.

**Caution**

Always use the supplied electrostatic discharge wristband when working with a powered ONS 15454. Plug the wristband cable into the ESD jack located on the lower-right edge of the shelf assembly.

- Step 2** If the attachment is good, verify that the cabling is securely connected.
- Step 3** If the cabling is good, verify that the pinouts are correct.
- Step 4** If the pinouts are correct, replace the receive cable.
- Step 5** If the alarm does not clear, log into the Technical Support Website at <http://www.cisco.com/techsupport> for more information or call Cisco TAC 1 800 553-2447 in order to report a service-affecting (SA) problem.
-

2.7.331 RSV-RT-EXCD-RINGLETO

Default Severity: Major (MJ), Service-Affecting (SA)

SONET Logical Object: RPRIF

The Reserved Bandwidth Exceeds Link Rate on Ringlet Zero alarm is raised by an ML-1000 card if the sum of reserved bandwidth configured on each station of ringlet 0 is greater than the link rate (circuit bandwidth). The alarm clears when the sum of the reserved bandwidth on each station falls below the link rate. In the case of SW-LCAS or LCAS circuits, the link rate is the working link rate, which will change when members are removed.

RSV-RT-EXCD-RINGLETO does not suppress any alarms, but it is suppressed by the [“RPR-PASSTHR” alarm on page 2-210](#).

Clear the RSV-RT-EXCD-RINGLETO Alarm

Step 1 At the CLI command prompt in privileged executive mode, enter the following command:

```
router#show rpr-ieee topology detail
```

This command's output shows the configured reserved bandwidth rate from each station.

Step 2 Reduce the reserved bandwidth on the alarmed station until the error clears. Enter the following CLI command in IEEE 802.17b-based RPR interface configuration mode:

```
router (config-if)#rpr-ieee tx-traffic rate-limit reserved
```

Step 3 If the alarm does not clear, log into the Technical Support Website at <http://www.cisco.com/techsupport> for more information or call Cisco TAC 1 800 553-2447 in order to report a service-affecting (SA) problem.

2.7.332 RSV-RT-EXCD-RINGLET1

Default Severity: Major (MJ), Service-Affecting (SA)

SONET Logical Object: RPRIF

The Reserved Bandwidth Exceeds Link Rate on Ringlet One alarm is raised by an ML-1000 card if the sum of reserved bandwidth configured on each station of ringlet 1 is greater than the link rate (circuit bandwidth). The alarm clears when the sum of the reserved bandwidth on each station falls below the link rate. In the case of SW-LCAS or LCAS circuits, the link rate is the working link rate, which will change when members are removed.

RSV-RT-EXCD-RINGLET1 does not suppress any alarms, but it is suppressed by the [“RPR-PASSTHR” alarm on page 2-210](#).

Clear the RSV-RT-EXCD-RINGLET1 Alarm

Step 1 At the CLI command prompt in privileged executive mode, enter the following command:

```
router#show rpr-ieee topology detail
```

This command's output shows the configured reserved bandwidth rate from each station.

- Step 2** Reduce the reserved bandwidth on the alarmed station until the error clears. Enter the following CLI command in IEEE 802.17b-based RPR interface configuration mode:
- ```
router (config-if)#rpr-ieee tx-traffic rate-limit reserved
```
- Step 3** If the alarm does not clear, log into the Technical Support Website at <http://www.cisco.com/techsupport> for more information or call Cisco TAC 1 800 553-2447 in order to report a service-affecting (SA) problem.
- 

## 2.7.333 RFI

For information about this alarm or condition, refer to the “Alarm Troubleshooting” chapter in the *Cisco ONS 15454 DWDM Troubleshooting Guide*. This guide discusses all DWDM alarms.

## 2.7.334 RFI-L

Default Severity: Not Reported (NR), Non-Service-Affecting (NSA)

SONET Logical Objects: EC1, OCN

DWDM Logical Object: TRUNK

A RFI Line condition occurs when the ONS 15454 detects an RFI in OC-N card SONET overhead because of a fault in another node. Resolving the fault in the adjoining node clears the RFI-L condition in the reporting node. RFI-L indicates that the condition is occurring at the line level.

### Clear the RFI-L Condition

- 
- Step 1** Log into the node at the far-end node of the reporting ONS 15454.
- Step 2** Identify and clear any alarms, particularly the “[LOS \(OCN\)](#)” alarm on [page 2-165](#).
- Step 3** If the condition does not clear, log into the Technical Support Website at <http://www.cisco.com/techsupport> for more information or call Cisco TAC 1 800 553-2447.
- 

## 2.7.335 RFI-P

Default Severity: Not Reported (NR), Non-Service-Affecting (NSA)

SONET Logical Objects: STSMON, STSTRM

The RFI Path condition occurs when the ONS 15454 detects an RFI in the an STS-1 signal SONET overhead because of a fault in another node. Resolving the fault in the adjoining node clears the RFI-P condition in the reporting node. RFI-P occurs in the terminating node in that path segment.

## Clear the RFI-P Condition

- 
- Step 1** Verify that the ports are enabled and in service (IS-NR) on the reporting ONS 15454:
- Confirm that the LED is correctly illuminated on the physical card.  
A green ACT/SBY LED indicates an active card. An amber ACT/SBY LED indicates a standby card.
  - To determine whether the OC-N port is in service, double-click the card in CTC to open the card view.
  - Click the **Provisioning > Line** tabs.
  - Verify that the Admin State column lists the port as IS.
  - If the Admin State column lists the port as OOS,MT or OOS,DSBLD, click the column and choose **IS**. Click **Apply**.



---

**Note** If ports managed into IS admin state are not receiving signals, the LOS alarm is either raised or remains, and the port service state transitions to OOS-AU,FLT.

---

- Step 2** To find the path and node failure, verify the integrity of the SONET STS circuit path at each of the intermediate SONET nodes.
- Step 3** Clear alarms in the node with the failure, especially the “[UNEQ-P](#)” alarm on page 2-253 or the “[UNEQ-V](#)” alarm on page 2-255.
- Step 4** If the condition does not clear, log into the Technical Support Website at <http://www.cisco.com/techsupport> for more information or call Cisco TAC 1 800 553-2447.
- 

## 2.7.336 RFI-V

Default Severity: Not Reported (NR), Non-Service-Affecting (NSA)

SONET Logical Objects: VTMON, VT-TERM

An RFI VT Layer condition occurs when the ONS 15454 detects an RFI in the SONET overhead because of a fault in another node. Resolving the fault in the adjoining node clears the RFI-V condition in the reporting node. RFI-V indicates that an upstream failure has occurred at the VT layer.

## Clear the RFI-V Condition

- 
- Step 1** Verify that the connectors are securely fastened and connected to the correct slot. For more information, refer to the “Install Cards and Fiber-Optic Cable” chapter in the *Cisco ONS 15454 Procedure Guide*.



---

**Caution** Always use the supplied electrostatic discharge wristband when working with a powered ONS 15454. Plug the wristband cable into the ESD jack located on the lower-right edge of the shelf assembly.

---

- Step 2** If connectors are correctly connected, verify that the DS-N

- Step 3** port is active and in service (IS-NR):
- Confirm that the LED is correctly illuminated on the physical card. A green ACT/SBY LED indicates an active card. An amber ACT/SBY LED indicates a standby card.
  - To determine whether the OC-N port is in service, double-click the card in CTC to open the card view.
  - Click the **Provisioning > Line** tabs.
  - Verify that the Admin State column lists the port as IS. If the Admin State column lists the port as OOS,MT or OOS,DSBLD, click the column and choose **IS**. Click **Apply**.



---

**Note** If ports managed into IS admin state are not receiving signals, the LOS alarm is either raised or remains, and the port service state transitions to OOS-AU,FLT.

---

- Step 4** If the ports are active and in service, use an optical test set to verify that the signal source does not have errors. For specific procedures to use the test set equipment, consult the manufacturer.
- Step 5** If the signal is valid, log into the node at the far-end of the reporting ONS 15454.
- Step 6** Clear alarms in the far-end node, especially the “UNEQ-P” alarm on page 2-253 or the “UNEQ-V” alarm on page 2-255.
- Step 7** If the condition does not clear, log into the Technical Support Website at <http://www.cisco.com/techsupport> for more information or call Cisco TAC 1 800 553-2447.
- 

## 2.7.337 RING-ID-MIS

Default Severity: Major (MJ), Non-Service-Affecting (NSA)

SONET Logical Object: OCN

DWDM Logical Object: OSC-RING

The Ring ID Mismatch condition refers to the ring ID in APC. It occurs when a ring name does not match other detectable node ring names, and can cause problems with applications that require data exchange with APC. This alarm is similar to the “RING-MISMATCH” alarm on page 2-208, but rather than apply to BLSDR ring protection, RING-ID-MIS applies to DWDM node discovery within the same network.



---

**Note** For more information about APC, refer to the *Cisco ONS 15454 DWDM Procedure Guide*.

---

### Clear the RING-ID-MIS Alarm

- Step 1** Complete the “Clear the RING-MISMATCH Alarm” procedure on page 2-208.
- Step 2** If the alarm does not clear, log into the Technical Support Website at <http://www.cisco.com/techsupport> for more information or call Cisco TAC 1 800 553-2447.
-

## 2.7.338 RING-MISMATCH

Default Severity: Major (MJ), Service-Affecting (SA)

SONET Logical Object: OCN

A Procedural Error Mismatch Ring alarm occurs when the ring name of the ONS 15454 node that is reporting the alarm does not match the ring name of another node in the BLSR. Nodes connected in a BLSR must have identical ring names to function. This alarm can occur during BLSR provisioning.

RING-MISMATCH is somewhat similar to RING-ID-MIS, but it applies to BLSR protection discovery instead of DWDM node discovery.



**Note**

For more information about DWDM cards, refer to the *Cisco ONS 15454 DWDM Reference Manual*.

### Clear the RING-MISMATCH Alarm

- Step 1** In node view, click the **Provisioning > BLSR** tabs.
- Step 2** Note the name in the Ring Name field.
- Step 3** Log into the next ONS 15454 node in the BLSR.
- Step 4** Complete the “[Identify a BLSR Ring Name or Node ID Number](#)” procedure on page 2-261.
- Step 5** If the ring name matches the ring name in the reporting node, repeat [Step 4](#) for the next ONS 15454 in the BLSR.
- Step 6** Complete the “[Change a BLSR Ring Name](#)” procedure on page 2-261.
- Step 7** Verify that the ring map is correct.
- Step 8** If the alarm does not clear, log into the Technical Support Website at <http://www.cisco.com/techsupport> for more information or call Cisco TAC 1 800 553-2447 in order to report a Service-Affecting (SA) problem.

## 2.7.339 RING-SW-EAST

Default Severity: Not Alarmed (NA), Non-Service-Affecting (NSA)

SONET Logical Object: OCN

The Ring Switch Is Active East Side condition occurs when a ring switch occurs at the east side of a BLSR using a Force Ring command. The condition clears when the switch is cleared. RING-SW-EAST is visible on the network view Alarms, Conditions, and History tabs. The port where the Force Ring was applied shows an “F” on the network view detailed circuit map.



**Note**

RING-SW-EAST is an informational condition and does not require troubleshooting.

## 2.7.340 RING-SW-WEST

Default Severity: Not Alarmed (NA), Non-Service-Affecting (NSA)

SONET Logical Object: OCN

The Ring Switch Is Active West Side condition occurs when a ring switch occurs at the west side of a BLSR using a Force Ring command. The condition clears when the switch is cleared. RING-SW-WEST is visible on the network view Alarms, Conditions, and History tabs. The port where the Force Ring was applied shows an “F” on the network view detailed circuit map.



**Note**

---

RING-SW-WEST is an informational condition and does not require troubleshooting.

---

## 2.7.341 ROLL

Default Severity: Not Alarmed (NA), Non-Service-Affecting (NSA)

SONET Logical Objects: STSMON, STSTRM, VT-TERM, VT-MON

The ROLL condition indicates that circuits are being rolled. This is typically carried out to move traffic for a maintenance operation or to perform bandwidth grooming. The condition indicates that a good signal has been received on the roll destination leg, but the roll origination leg has not yet been dropped. The condition clears when the roll origination leg is dropped.



**Note**

---

ROLL is an informational condition and does not require troubleshooting.

---

## 2.7.342 ROLL-PEND

Default Severity: Not Alarmed (NA), Non-Service-Affecting (NSA)

SONET Logical Objects: STSMON, STSTRM, VT-TERM, VT-MON

ROLL-PEND indicates that a roll process has been started, but a good signal has not been received yet by the roll destination leg. This condition can be raised individually by each path in a bulk circuit roll.

The condition clears when a good signal has been received on the roll destination leg.



**Note**

---

ROLL-PEND is an informational condition and does not require troubleshooting.

---

## 2.7.343 ROUTE-OVERFLOW

Default Severity: Minor (MN), Non-Service-Affecting (NSA)

SONET Logical Objects: NE

DWDM Logical Object: NE regardless of MSTP or MSPP

The ROUTE-OVERFLOW indicates the condition when the OSPF routing table exceeds 700 routes. The symptoms for this condition are loss of visibility to a node or network, inability to access a node using CTC, CTM, Telnet, Ping, and so on.

## Clear the ROUTE-OVERFLOW Condition

---

**Step 1** Reconfigure the OSPF network to less than 700 routes.

---

### 2.7.344 RPR-PASSTHR

Default Severity: Not Alarmed (NA), Non-Service-Affecting (NSA)

SONET Logical Object: RPRIF

The IEEE 802.17 b-based RPR Interface in Pass-Through Mode condition indicates that an ML card's IEEE 802.17 b-based RPR interface is not participating in a ring. Instead, the card is behaving like a passive device that allows the signal to transit but does not manipulate it. Pass-through mode itself is hitless.

You can manually place an ML card into (or out of) pass-through mode using the Cisco IOS CLI command SHUTDOWN (SHUT) for such reasons as adding, removing, or servicing the node. To do so is hitless.

The ML-1000 automatically enters pass-through mode if either of the following conditions is true:

- Redundant interconnect (RI) is configured and the ML card is in primary mode (that is, single traffic queue mode), standby state.
- RI is configured and the RI interface goes down during a “WTR” alarm on page 2-259, while the ML card is in secondary mode (that is, dual traffic queue mode) on a Cisco proprietary RPR ring.



**Note**

---

For GFP and HDLC mode, the ML card shutdown (SHUT) command causes an “AIS-P” alarm on page 2-38 to be sent to the peer. But in IEEE 802.17b-based RPR mode, AIS-P is not inserted toward the peer.

---

The RPR-PASSTHR condition suppresses the following alarms:

- [FORCED-REQ](#), page 112
- [LINK-KEEPALIVE](#), page 142
- [MAN-REQ](#), page 179
- [MAX-STATIONS](#), page 181
- [RSV-RT-EXCD-RINGLET0](#), page 204
- [RSV-RT-EXCD-RINGLET1](#), page 204
- [RPR-PROT-ACTIVE](#), page 212
- [RPR-PROT-CONFIG-MISM](#), page 213
- [RPR-SD](#), page 214
- [RPR-SF](#), page 215
- [RPR-SPAN-MISMATCH](#), page 215
- [WTR](#), page 259



If RPR-PASSTHR is raised—meaning that this RPR-IEEE interface is not available—one or more of its peer nodes might raise the “RPR-PEER-MISS” alarm on page 2-211. RPR-PASSTHR does not suppress the “RPR-PEER-MISS” alarm on page 2-211, or the “RPR-RI-FAIL” alarm on page 2-213.

## Clear the RPR-PASSTHR Condition

- 
- Step 1** If the ML card was manually configured shut down using the CLI command SHUTDOWN (SHUT), enter the following command at the command prompt:
- ```
router#no shut
```
- Step 2** If the card is in pass-through mode due to being in an RI primary mode standby state, either the IEEE 802.17b-based RPR interface is down or the interconnect interface is down. You must clear the root cause of either problem to clear the pass-through. To trace the root cause problem in the RPR-IEEE interface setup, enter the following CLI command in privileged executive mode:
- ```
router#show interface rpr-ieee 0
```
- Step 3** View the command output and locate the RI information line. It displays the name of the monitored interfaces as “monitoring ring interface,” or “monitoring interconnect interface.”
- Step 4** Locate and clear any trouble on the monitored interface. Trouble might be indicated on that interface through previous alarms that occurred before RPR-PASSTHR was raised.
- Step 5** If the card is in pass-through mode while in RI secondary mode when the interconnect fails, pass-through mode should clear automatically in 60 seconds.
- Step 6** If the condition does not clear, log into the Technical Support Website at <http://www.cisco.com/techsupport> for more information or call Cisco TAC (1 800 553-2447).
- 

## 2.7.345 RPR-PEER-MISS

Default Severity: Major (MJ), Service-Affecting (SA)

SONET Logical Object: RPRIF

The IEEE 802.17-based RPR Peer Node Is Missing condition is raised by an ML card when RI is configured on the card, but this station does not detect its peer station in the topology. The condition clears when the peers detect each other.

## Clear the RPR-PEER-MISS Condition

- 
- Step 1** Determine whether the peer MAC address is properly configured by completing the following steps:
- Enter the following CLI command in privileged executive mode:

```
router#show interface rpr-ieee 0
```

This command’s output will include information, similar to the following, about the RPR-IEEE interface raising the condition:

```
Hardware is RPR-IEEE Channelized SONET, address is 000e.8312.bcf0 (bia 000e.87312.bfc0)
```

- b. Verify that the alarmed interface's configured peer MAC address is the correct MAC address for the peer card. A card in primary mode need to list the peer MAC address of the card operating in secondary mode; the secondary card needs to list the peer MAC address of the primary card. Peer MAC address information is contained in the same "show interface rpr-ieee 0" command output. In the following line example, the RPR-IEEE interface raising the alarm is primary; it is in active mode, and its configured peer, the secondary card, is MAC address 000e.8312.b870:

```
RI: primary,active peer mac 000e.8312.b870
```



**Note** The primary and secondary cards do not have to be neighbors on the ring.



**Note** If RI is configured, then RI information is displayed in the "show interface rpr 0" output.

To correct the MAC address configuration, refer to the *Cisco ONS 15454 and Cisco ONS 15454 SDH Ethernet Card Software Feature and Configuration Guide* for procedures.

- Step 2** If the condition does not clear, enter the following command in privileged executive mode:

```
router#show rpr-ieee protection
```

- Step 3** The command output, similar to the following lines, shows whether any protection switches are active:

```
West Span Failures: none
East Span Failures: none
```

A protection switch can cause an RPR-PEER-MISS condition. You may also see the "RPR-PROT-ACTIVE" alarm on page 2-212 raised for a span. Clear any protection issues.

- Step 4** If the condition does not clear, correct any issues on the peer node that would cause it to go into pass-through mode, which can cause the peer to raise RPR-PEER-MISS.
- Step 5** If the condition does not clear, log into the Technical Support Website at <http://www.cisco.com/techsupport> for more information or call Cisco TAC 1 800 553-2447.

## 2.7.346 RPR-PROT-ACTIVE

Default Severity: Not Alarmed (NA), Non-Service-Affecting (NSA)

SONET Logical Object: RPRIF

The IEEE 802.17b-based RPR Protection is Active condition, raised by the ML card, indicates that ring protection is active and that steering protection as defined in IEEE 802.17b is active.

IEEE 802.17b-based RPR provides hitless protection switching for all protected traffic on a ring. Its steering protection mechanism ensures that each station receives span change information (such as fail or restoration) in time to make protection switching decisions within the 50-millisecond time frame.

The condition clears when steering protection is no longer active. For more information about steering, refer to the *Cisco ONS 15454 and Cisco ONS 15454 SDH Ethernet Card Software Feature and Configuration Guide*.

This condition is suppressed by the "RPR-PASSTHR" alarm on page 2-210.

## Clear the RPR-PROT-ACTIVE Condition

- 
- Step 1** Locate and clear any service-affecting SONET error that might have caused a protection switch, in turn triggering the RPR-PROT-ACTIVE condition. Clearing the SONET condition will clear RPR-PROT-ACTIVE.
- Step 2** If the condition does not clear, log into the Technical Support Website at <http://www.cisco.com/techsupport> for more information or call Cisco TAC 1 800 553-2447.
- 

## 2.7.347 RPR-PROT-CONFIG-MISM

Default Severity: Major (MJ), Service-Affecting (SA)

SONET Logical Object: RPRIF

The IEEE 802.17b-based RPR Protection Configuration Mismatched alarm is raised by an ML card when it detects that its steering protection scheme is mismatched with other vendors' equipment configured for wrapping protection. The ONS 15454 does not support IEEE 802.17b's optional wrapping scheme.

The alarm clears when the other vendor's equipment configuration is changed to utilize steering protection.

RPR-PROT-CONFIG-MISM is suppressed by the “RPR-PASSTHR” alarm on page 2-210.

## Clear the RPR-PROT-CONFIG-MISM Alarm

- 
- Step 1** You cannot clear this alarm from the ONS 15454; rather, it is caused by incompatible vendor equipment configuration. See that equipment's support information to correct the configuration for steering instead of wrapping. This, in turn, will cause RPR-PROT-CONFIG-MISM to clear.
- Step 2** If the alarm does not clear, log into the Technical Support Website at <http://www.cisco.com/techsupport> for more information or call Cisco TAC (1 800 553-2447) to report a Service-Affecting (SA) problem.
- 

## 2.7.348 RPR-RI-FAIL

Default Severity: Major (MJ), Service-Affecting (SA)

SONET Logical Object: RPRIF

The IEEE 802.17b-based RPR RI Fail condition is raised by an ML card in primary or secondary mode. If a card is in primary mode, a Gigabit Ethernet interface can cause an interconnect interface (IC) failure. (The IC includes the Gigabit Ethernet interface and possibly a port channel interface.) In primary mode, RPR-RI-FAIL can also be raised in response to a downed ring interface. In secondary mode, the only possible cause of this condition is IC failure.

The alarm clears when the IEEE 802.17b-based RPR interface returns to Init modes and faults, if present, are cleared. RPR-RI-FAIL is suppressed by the “RPR-PASSTHR” alarm on page 2-210.

## Clear the RPR-RI-FAIL Condition

- 
- Step 1** If the card is in primary mode, enter the following command at the CLI in privileged executive mode:
- ```
router#show interface rpr-ieee 0
```
- Step 2** The RI information line displays the name of the monitored interfaces and says either “monitoring ring interface,” or “monitoring interconnect interface.”
- Step 3** Determine why the monitored interface is down. It can occur because the ring interface has been shut down using the “shutdown” CLI command, or because both SONET circuits are down or OOS.
- Step 4** If correcting the previous problem on a primary interface does not clear the condition, or if the condition is raised on a card in secondary mode, the IC failure root cause must be corrected. This can be due to a fiber pull, having link protocol down, or shut down interfaces.
- Link state is indicated in the “show interface rpr-ieee 0” output on the following line:
RPR-IEEE0 is up, line protocol is up
 - A shutdown is indicated if a node is in pass-through mode. The same command output indicates whether or not this is the case:
MAC passthrough not set
- Step 5** If the condition does not clear, log into the Technical Support Website at <http://www.cisco.com/techsupport> for more information or call Cisco TAC (1 800 553-2447).
-

2.7.349 RPR-SD

Default Severity: Not Alarmed (NA), Non-Service-Affecting (NSA)

SONET Logical Objects: ML100T, ML1000, MLFX

The IEEE 802.17b-based RPR Signal Degrade condition indicates that a minor signal degradation has occurred on an IEEE- RPR ring that, if not overridden, can deactivate the link. The RPR-SD condition is reported if the SONET “SD-P” alarm on page 2-221, is raised on the circuit which carries the span. The RPR-SD condition clears when the SONET signal degrade clears.

RPR-SD suppresses the “MAN-REQ” alarm on page 2-179 and the “WTR” alarm on page 2-259.

It is suppressed by the following alarms:

- [FORCED-REQ, page 112](#)
- [RPR-PASSTHR, page 210](#)
- [RPR-SF, page 215](#)

Clear the RPR-SD Condition

-
- Step 1** Complete the “[Clear the SD-P Condition](#)” procedure on page 2-222 to clear this secondary condition.

- Step 2** If the condition does not clear, log into the Technical Support Website at <http://www.cisco.com/techsupport> for more information or call Cisco TAC (1 800 553-2447) to report a Service-Affecting (SA) problem.
-

2.7.350 RPR-SF

Default Severity: Not Alarmed (NA), Non-Service-Affecting (NSA)

SONET Logical Objects: ML100T, ML1000, MLFX

The IEEE 802.17b-based RPR Signal Fail condition indicates a signal loss or major signal degradation that deactivates the RPR-IEEE link. The failure that raises RPR-SF can be attributable to any of the following alarms:

- [AIS-P, page 38](#)
- [GFP-LFD, page 119](#)
- [LOP-P, page 155](#)
- [PDI-P, page 194](#)
- [PLM-P, page 196](#)
- [RFI-P, page 205](#)
- [TIM-P, page 246](#)
- [UNEQ-P, page 253](#)
- [VCG-DOWN, page 257](#)

The RPR-SF condition can also occur if a SONET circuit's state is UNASSIGNED (not provisioned).

This condition clears when these primary cause alarms are cleared. RPR-SF is suppressed by the “RPR-PASSTHR” alarm on page 2-210 or the “FORCED-REQ” alarm on page 2-112. RPR-SF itself suppresses the following alarms:

- [MAN-REQ, page 179](#)
- [RPR-SD, page 214](#)
- [WTR, page 259](#)

Clear the RPR-SF Condition

- Step 1** Complete the trouble-clearing procedure in this chapter for any primary cause SONET failure condition as previously listed.
- Step 2** If the condition does not clear, log into the Technical Support Website at <http://www.cisco.com/techsupport> for more information or call Cisco TAC (1 800 553-2447) to report a Service-Affecting (SA) problem.
-

2.7.351 RPR-SPAN-MISMATCH

Default Severity: Major (MJ), Service-Affecting (SA)

SONET Logical Objects: ML100T, ML1000, MLFX

The IEEE 802.17b-based RPR-SPAN-MISMATCH alarm is caused by span misprovisioning, span forced switching, physical miscabling, or a circuit loopback.

Miscabling problems between this node's east or west span and its neighboring span in the same direction can also cause this alarm, as will provisioning an XC loopback on a circuit that carries RPR-IEEE traffic.

If a traffic-affecting issue such as the “AIS-P” alarm on page 2-38, the “GFP-LFD” alarm on page 2-119, the “LOP-P” alarm on page 2-155, the “RFI-P” alarm on page 2-205, or the “UNEQ-P” alarm on page 2-253 occurs, it in turn suppresses RPR-SPAN-MISMATCH.



Note

Clearing a circuit XC loopback does not always cause the loopback to clear. If this is the case, a FORCE switch is used to clear the RPR-SPAN-MISMATCH alarm. The FORCE might cause a traffic hit.

RPR- SPAN-MISMATCH is suppressed by “RPR-PASSTHR” alarm on page 2-210.

Clear the RPR-SPAN-MISMATCH Alarm

-
- Step 1** Locate and clear any primary cause provisioning errors.
 - Step 2** If the alarm does not clear, locate and correct any span cabling errors.
 - Step 3** If the alarm does not clear, look for and clear XC loopbacks on the spans.
 - Step 4** If the alarm does not clear, configure a FORCE switch on the 802.17b-based RPR span and then clear the switch. To do this, enter the following CLI command in RPR-IEEE interface provisioning mode:

```
router(config)#rpr-ieee protection request forced-switch {east | west}
```

Clear the switch by entering the following command:

```
router(config)#no rpr-ieee protection request forced-switch {east | west}
```
 - Step 5** If the alarm does not clear, log into the Technical Support Website at <http://www.cisco.com/techsupport> for more information or call Cisco TAC (1 800 553-2447) to report a Service-Affecting (SA) problem.
-

2.7.352 RPRW

Default Severity: Not Alarmed (NA), Non-Service-Affecting (NSA)

SONET Logical Objects: ML100T, ML1000, MLFX

The Cisco proprietary RPR Wrapped condition applies to ML-Series card and occurs when the Cisco proprietary RPR protocol initiates a ring wrap due to a fiber cut, node failure, node restoration, new node insertion, or other traffic problem. It can also be raised if the POS port has an Admin down condition. (In this case, you will not see any SONET-level alarms or the “TPTFAIL (ML100T, ML1000, MLFX)” alarm on page 2-250.). The POS port can go down for one of the following reasons : Deletion of circuit on the POS port, SPR KeepAlive failure when it is configured.

When the wrap occurs, traffic is redirected to the original destination by sending it in the opposite direction around the ring after a link state change or after receiving any SONET path-level alarms.

**Note**

ML-Series card POS interfaces normally send the “PDI-P” alarm on page 2-194 to the far end when the POS link goes down or when Cisco proprietary RPR wraps. ML-Series card POS interfaces do not send a PDI-P alarm to the far end when this alarm is detected, when the alarm is being sent to the far end, or when the only defects being detected are the “GFP-LFD” alarm on page 2-119, the “GFP-CSF” alarm on page 2-117, the VCAT “LOM” alarm on page 2-155, or the VCAT “SQM” alarm on page 2-232.

**Note**

For more information about ML-Series Ethernet cards, refer to the *Cisco ONS 15454 and Cisco ONS 15454 SDH Ethernet Card Software Feature and Configuration Guide*.

Clear the RPRW Condition

- Step 1** If a circuit on the POS port part of SPR interface had been deleted, recreate the circuit on the POS port for this alarm to clear ring wrapping.
- Step 2** Look for and clear any service-affecting SONET path-level alarms on the affected circuit, such as the “LOP-P” alarm on page 2-155, the “LOS-P (TRUNK)” alarm on page 2-167, the “PLM-P” alarm on page 2-196, or the “TIM-P” alarm on page 2-246. Clearing such an alarm can also clear RPRW.
- Step 3** If the condition does not clear, look for and clear any service alarms for the ML-Series card itself, such as the “CARLOSS (CE1000, CE100T)” alarm on page 2-59, the “CARLOSS (ML1000, ML100T, MLFX)” alarm on page 2-66, the “TPTFAIL (CE100T, CE1000)” alarm on page 2-248, or the “TPTFAIL (ML100T, ML1000, MLFX)” alarm on page 2-250.
- Step 4** If the condition does not clear, log into the Technical Support Website at <http://www.cisco.com/techsupport> for more information or call Cisco TAC (1 800 553-2447).

2.7.353 RUNCFG-SAVENEED

Default Severity: Not Alarmed (NA), Non-Service-Affecting (NSA)

SONET Logical Object: EQPT

The Run Configuration Save Needed condition occurs when you change the running configuration file for ML-Series cards. It is a reminder that you must save the change to the startup configuration file for it to be permanent.

The condition clears after you save the running configuration to the startup configuration, such as by entering the following command in privileged executive mode in the CLI:

```
router# copy run start
```

If you do not save the change, the change is lost after the card reboots. If the command “copy run start” is executed in configuration mode and not privileged executive mode, the running configuration will be saved, but the alarm will not clear.

**Note**

For more information about the ML-Series Ethernet cards, refer to the *Cisco ONS 15454 and Cisco ONS 15454 SDH Ethernet Card Software Feature and Configuration Guide*.

2.7.354 SD (DS1, DS3)

Default Severity: Not Alarmed (NA), Non-Service-Affecting (NSA)

SONET Logical Objects: DS1, DS3

A Signal Degrade (SD) condition for DS-1 or DS-3 occurs when the quality of an electrical signal on a DS3XM-6, DS3XM-12, or DS3/EC1-48 card has exceeded the BER signal degrade threshold. Signal degrade is defined by Telcordia as a soft failure condition. SD and signal fail (SF) both monitor the incoming BER and are similar, but SD is triggered at a lower bit error rate than SF.

The BER threshold is user-provisionable and has a range for SD from 1E-9 dBm to 1E-5 dBm.

SD can be reported on electrical card ports that are In-Service and Normal (IS-NR); Out-of-Service and Autonomous, Automatic In-Service (OOS-AU,AIS); or Out-of-Service and Management, Maintenance (OOS-MA,MT), but not in the Out-of-Service and Management, Disabled (OOS-MA,DSBLD) service state. The BER count increase associated with this alarm does not take an IS-NR port out of service, but if it occurs on an AINS port, the alarm prevents the port from going into service.

The SD condition clears when the BER level falls to one-tenth of the threshold level that triggered the condition. A BER increase is sometimes caused by a physical fiber problem such as a faulty fiber connection, a bend in the fiber that exceeds the permitted bend radius, or a bad fiber splice. SD can also be caused by repeated XC10G card switches that in turn can cause switching on the lines or paths.



Warning

Invisible laser radiation could be emitted from the end of the unterminated fiber cable or connector. Do not stare into the beam directly with optical instruments. Viewing the laser output with certain optical instruments (for example, eye loupes, magnifiers, and microscopes) within a distance of 100 mm could pose an eye hazard. Statement 1056



Warning

Use of controls, adjustments, or performing procedures other than those specified could result in hazardous radiation exposure. Statement 1057



Note

Some levels of BER errors (such as 1E-9 dBm) take a long period to raise or clear, about 9,000 seconds, or 150 minutes. If the SD threshold is provisioned at 1E-9 dBm rate, the SD alarm needs at least one and one-half hours to raise and then another period at least as long to clear.



Note

The recommended test set for use on all SONET ONS electrical cards is the Omniber 718. For specific procedures to use the test set equipment, consult the manufacturer.

Clear the SD (DS1, DS3) Condition

- Step 1** If the condition applies for a DS-3 line on a DS3XM-6, DS3XM-12, DS3E-12, or DS3/EC1-48 card, complete the [“Clear a DS3XM-6, DS3XM-12, or DS3E-12 Card Loopback Circuit” procedure on page 2-277](#). If the condition applies to any other DS-N card (DS3i-N-14, DS3-12, DS3i-N-14, or DS1/E1-56) complete the [“Clear Other Electrical Card or Ethernet Card Loopbacks” procedure on page 2-278](#).

**Caution**

Always use the supplied electrostatic discharge wristband when working with a powered ONS 15454. Plug the wristband cable into the ESD jack located on the lower-right edge of the shelf assembly.

-
- Step 2** Ensure that the fiber connector for the card is completely plugged in. For more information about fiber connections and card insertion, refer to the “Install Cards and Fiber-Optic Cable” chapter in the *Cisco ONS 15454 Procedure Guide*.
- Step 3** If the BER threshold is correct and at the expected level, use an optical test set to measure the power level of the line to ensure it is within guidelines. For specific procedures to use the test set equipment, consult the manufacturer.
- Step 4** If the optical power level is good, verify that optical receive levels are within the acceptable range.
- Step 5** If receive levels are good, clean the fibers at both ends according to site practice. If no site practice exists, complete the procedure in the “Maintain the Node” chapter in the *Cisco ONS 15454 Procedure Guide*.
- Step 6** If the condition does not clear, verify that single-mode fiber is used.
- Step 7** If the fiber is of the correct type, verify that a single-mode laser is used at the far-end node.
- Step 8** Clean the fiber connectors at both ends for a signal degrade according to site practice.
- Step 9** Verify that a single-mode laser is used at the far end.
- Step 10** If the problem does not clear, the transmitter at the other end of the optical line could be failing and require replacement. Refer to the “[2.9.4 Physical Card Reseating, Resetting, and Replacement](#)” section on page 2-272.
- Step 11** If the condition does not clear, log into the Technical Support Website at <http://www.cisco.com/techsupport> for more information or call Cisco TAC 1 800 553-2447.
-

2.7.355 SD (E1)

Default Severity: Not Alarmed (NA), Non-Service-Affecting (NSA)

SONET Logical Object: E1

An SD condition for an E1 occurs on a DS1/E1-56 card in E1 only mode when the quality of an electrical signal has exceeded the BER signal degrade threshold.

SD is triggered at a lower bit error rate than SF. The SD BER threshold is user-provisionable and ranges from 1E-9 dBm to 1E-5 dBm.

SD can be reported on electrical card ports that are In-Service and Normal (IS-NR); Out-of-Service and Autonomous, Automatic In-Service (OOS-AU,AIS); or Out-of-Service and Management, Maintenance (OOS-MA,MT) but not in the Out-of-Service and Management, Disabled (OOS-MA,DSBLD) service state. The BER count increase associated with this alarm does not take an IS-NR port out of service, but if it occurs on an AINS port, the alarm prevents the port from going into service.

The SD condition clears when the BER level falls to one-tenth of the threshold level that triggered the condition. A BER increase is sometimes caused by a physical fiber problem such as a faulty fiber connection, a bend in the fiber that exceeds the permitted bend radius, or a bad fiber splice. SD can also be caused by repeated XC10G card switches that in turn can cause switching on the lines or paths.

**Warning**

Invisible laser radiation could be emitted from the end of the unterminated fiber cable or connector. Do not stare into the beam directly with optical instruments. Viewing the laser output with certain optical instruments (for example, eye loupes, magnifiers, and microscopes) within a distance of 100 mm could pose an eye hazard. Statement 1056

**Warning**

Use of controls, adjustments, or performing procedures other than those specified could result in hazardous radiation exposure. Statement 1057

**Note**

Some levels of BER errors (such as 1E-9 dBm) take a long period to raise or clear, about 9,000 seconds, or 150 minutes. If the SD threshold is provisioned at 1E-9 dBm rate, the SD alarm needs at least one and a half hours to raise and then another period at least as long to clear.

**Note**

The recommended test set for use on all SONET ONS electrical cards is the Omniber 718. For specific procedures to use the test set equipment, consult the manufacturer.

Clear the SD (E1) Condition

Step 1 Complete the [“Clear Other Electrical Card or Ethernet Card Loopbacks” procedure on page 2-278.](#)

**Caution**

Always use the supplied electrostatic discharge wristband when working with a powered ONS 15454. Plug the wristband cable into the ESD jack located on the lower-right edge of the shelf assembly.

Step 2 Ensure that the fiber connector for the card is completely plugged in. For more information about fiber connections and card insertion, refer to the “Install Cards and Fiber-Optic Cable” chapter in the *Cisco ONS 15454 Procedure Guide*.

Step 3 If the BER threshold is correct and at the expected level, use an optical test set to measure the power level of the line to ensure it is within guidelines. For specific procedures to use the test set equipment, consult the manufacturer.

Step 4 If the optical power level is good, verify that optical receive levels are within the acceptable range.

Step 5 If receive levels are good, clean the fibers at both ends according to site practice. If no site practice exists, complete the procedure in the “Maintain the Node” chapter of the *Cisco ONS 15454 Procedure Guide*.

Step 6 If the condition does not clear, verify that single-mode fiber is used.

Step 7 If the fiber is of the correct type, verify that a single-mode laser is used at the far-end node.

Step 8 Clean the fiber connectors at both ends for a signal degrade according to site practice.

Step 9 If the problem does not clear, the transmitter at the other end of the optical line could be failing and require replacement. Refer to the [“2.9.4 Physical Card Reseating, Resetting, and Replacement” section on page 2-272.](#)

Step 10 If the condition does not clear, log into the Technical Support Website at <http://www.cisco.com/techsupport> for more information or call Cisco TAC 1 800 553-2447.

2.7.356 SD (TRUNK)

For information about this alarm or condition, refer to the “Alarm Troubleshooting” chapter in the *Cisco ONS 15454 DWDM Troubleshooting Guide*. This guide discusses all DWDM alarms.

2.7.357 SD-L

Default Severity: Not Alarmed (NA), Non-Service-Affecting (NSA)

SONET Logical Objects: EC1, OCN

An SD Line condition is similar to the “SD (DS1, DS3)” condition on page 2-218. It applies to the line level of the SONET signal and travels on the B2 byte of the SONET overhead.

An SD-L on an Ethernet or OC-N card does not cause a protection switch. If the alarm is reported on a card that has also undergone a protection switch, the SD BER count continues to accumulate. The condition is superseded by higher-priority alarms such as the “LOF (EC1)” alarm on page 2-151, the “LOF (OCN)” alarm on page 2-152, the “LOS (EC1)” alarm on page 2-163, and the “LOS (OCN)” alarm on page 2-165.



Note

For more information about Ethernet cards, refer to the *Cisco ONS 15454 and Cisco ONS 15454 SDH Ethernet Card Software Feature and Configuration Guide*.

Clear the SD-L Condition

-
- Step 1** Complete the “Clear the SD (DS1, DS3) Condition” procedure on page 2-218.
- Step 2** If the condition does not clear, log into the Technical Support Website at <http://www.cisco.com/techsupport> for more information or call Cisco TAC 1 800 553-2447.
-

2.7.358 SD-L (TRUNK)

For information about this alarm or condition, refer to the “Alarm Troubleshooting” chapter in the *Cisco ONS 15454 DWDM Troubleshooting Guide*. This guide discusses all DWDM alarms.

2.7.359 SD-P

Default Severity: Not Alarmed (NA), Non-Service-Affecting (NSA)

SONET Logical Objects: STSMON, STSTRM

An SD Path condition is similar to the “SD (DS1, DS3)” condition on page 2-218, but it applies to the path (STS) layer of the SONET overhead. A path or STS-level SD alarm travels on the B3 byte of the SONET overhead.

For UPSR protected circuits, the BER threshold is user-provisionable and has a range for SD from 1E-9 dBm to 1E-5 dBm. For BLSR 1+1 and unprotected circuits, the BER threshold value is not user-provisionable and the error rate is hard-coded to 1E-6 dBm.

On UPSRs, an SD-P condition causes a switch from the working card to the protect card at the path (STS) level. On BLSR, 1+1, and on unprotected circuits, an SD-P condition does not cause switching.

The BER increase that causes the condition is sometimes caused by a physical fiber problem such as a poor fiber connection, a bend in the fiber that exceeds the permitted bend radius, or a bad fiber splice.

The SD clears when the BER level falls to one-tenth of the threshold level that triggered the alarm.

Clear the SD-P Condition

-
- Step 1** Complete the “[Clear the SD \(DS1, DS3\) Condition](#)” procedure on page 2-218.
- Step 2** If the condition does not clear, log into the Technical Support Website at <http://www.cisco.com/techsupport> for more information or call Cisco TAC 1 800 553-2447.
-

2.7.360 SD-V

Default Severity: Not Alarmed (NA), Non-Service-Affecting (NSA)

SONET Logical Objects: VT-MON, VT-TERM

An SD-V condition is similar to the “[SD \(DS1, DS3\)](#)” condition on page 2-218, but it applies to the VT layer of the SONET overhead.

For UPSR protected circuits, the BER threshold is user-provisionable and has a range for SD from 1E-9 dBm to 1E-5 dBm. For BLSR 1+1 and unprotected circuits, the BER threshold value is not user-provisionable and the error rate is hard-coded to 1E-6 dBm.

On UPSRs, an SD-V condition does not cause a switch from the working card to the protect card at the path (STS) level. On BLSR, 1+1, and on unprotected circuits, an SD-V condition does not cause switching.

The BER increase that causes the alarm is sometimes caused by a physical fiber problem such as a poor fiber connection, a bend in the fiber that exceeds the permitted bend radius, or a bad fiber splice.

The SD alarm clears when the BER level falls to one-tenth of the threshold level that triggered the alarm.

Clear the SD-V Condition

-
- Step 1** Complete the “[Clear the SD \(DS1, DS3\) Condition](#)” procedure on page 2-218.
- Step 2** If the condition does not clear, log into the Technical Support Website at <http://www.cisco.com/techsupport> for more information or call Cisco TAC 1 800 553-2447.
-

2.7.361 SF (DS1, DS3)

Default Severity: Not Alarmed (NA), Non-Service-Affecting (NSA)

SONET Logical Objects: DS1, DS3

A Signal Fail (SF) condition occurs when the quality of the signal has exceeded the BER signal failure threshold. Signal failure is defined by Telcordia as a “hard failure” condition. The SD and SF conditions both monitor the incoming BER error rate and are similar conditions, but SF is triggered at a higher BER than SD.

The BER threshold is user-provisionable and has a range for SF from 1E-5 dBm to 1E-3 dBm.



Warning

Invisible laser radiation could be emitted from the end of the unterminated fiber cable or connector. Do not stare into the beam directly with optical instruments. Viewing the laser output with certain optical instruments (for example, eye loupes, magnifiers, and microscopes) within a distance of 100 mm could pose an eye hazard. Statement 1056



Warning

Use of controls, adjustments, or performing procedures other than those specified could result in hazardous radiation exposure. Statement 1057

Clear the SF (DS1, DS3) Condition

Step 1 Complete the “[Clear the SD \(DS1, DS3\) Condition](#)” procedure on page 2-218.



Caution

Always use the supplied electrostatic discharge wristband when working with a powered ONS 15454. Plug the wristband cable into the ESD jack located on the lower-right edge of the shelf assembly.

Step 2 If the condition does not clear, log into the Technical Support Website at <http://www.cisco.com/techsupport> for more information or call Cisco TAC 1 800 553-2447.

2.7.362 SF (E1)

Default Severity: Not Alarmed (NA), Non-Service-Affecting (NSA)

SONET Logical Object: E1

An SF condition for an E1 occurs on a DS1/IE1-56 card in E1 only mode when the quality of the signal has exceeded the BER signal failure threshold.

SF monitors the incoming BER error rate just as SD does, but SF is triggered at a higher BER than SD. The SF BER threshold is user-provisionable and has a range for SF from 1E-5 dBm to 1E-3 dBm.



Warning

Invisible laser radiation could be emitted from the end of the unterminated fiber cable or connector. Do not stare into the beam directly with optical instruments. Viewing the laser output with certain optical instruments (for example, eye loupes, magnifiers, and microscopes) within a distance of 100 mm could pose an eye hazard. Statement 1056



Warning

Use of controls, adjustments, or performing procedures other than those specified could result in hazardous radiation exposure. Statement 1057

Clear the SF (E1) Condition

Step 1 Complete the “[Clear the SD \(E1\) Condition](#)” procedure on page 2-220.

**Caution**

Always use the supplied electrostatic discharge wristband when working with a powered ONS 15454. Plug the wristband cable into the ESD jack located on the lower-right edge of the shelf assembly.

Step 2 If the condition does not clear, log into the Technical Support Website at <http://www.cisco.com/techsupport> for more information or call Cisco TAC 1 800 553-2447.

2.7.363 SF (TRUNK)

For information about this alarm or condition, refer to the “Alarm Troubleshooting” chapter in the *Cisco ONS 15454 DWDM Troubleshooting Guide*. This guide discusses all DWDM alarms.

2.7.364 SF-L

Default Severity: Not Alarmed (NA), Non-Service-Affecting (NSA)

SONET Logical Objects: EC1, OCN

An SF Line condition is similar to the “[SF \(DS1, DS3\)](#)” condition on page 2-222, but it applies to the line layer B2 overhead byte of the SONET signal. It can trigger a protection switch.

The SF-L condition clears when the BER level falls to one-tenth of the threshold level that triggered the condition. A BER increase is sometimes caused by a physical fiber problem, including a poor fiber connection, a bend in the fiber that exceeds the permitted bend radius, or a bad fiber splice.

The condition is superseded by higher-priority alarms such as the “[LOF \(EC1\)](#)” alarm on page 2-151, the “[LOS \(EC1\)](#)” alarm on page 2-163, and the “[LOS \(OCN\)](#)” alarm on page 2-165.

Clear the SF-L Condition

Step 1 Complete the “[Clear the SD \(DS1, DS3\) Condition](#)” procedure on page 2-218.

Step 2 If the condition does not clear, log into the Technical Support Website at <http://www.cisco.com/techsupport> for more information or call Cisco TAC 1 800 553-2447.

2.7.365 SF-L (TRUNK)

For information about this alarm or condition, refer to the “Alarm Troubleshooting” chapter in the *Cisco ONS 15454 DWDM Troubleshooting Guide*. This guide discusses all DWDM alarms.

2.7.366 SF-P

Default Severity: Not Alarmed (NA), Non-Service-Affecting (NSA)

SONET Logical Objects: STSMON, STSTRM

An SF Path condition is similar to the “[SF \(DS1, DS3\) condition on page 2-222](#)”, but it applies to the path (STS) layer B3 byte of the SONET overhead. It can trigger a protection switch.

The SF-P condition clears when the BER level falls to one-tenth of the threshold level that triggered the condition. A BER increase is sometimes caused by a physical fiber problem, including a poor fiber connection, a bend in the fiber that exceeds the permitted bend radius, or a bad fiber splice.

Clear the SF-P Condition

-
- Step 1** Complete the “[Clear the SD \(DS1, DS3\) Condition](#)” procedure on page 2-218.
- Step 2** If the condition does not clear, log into the Technical Support Website at <http://www.cisco.com/techsupport> for more information or call Cisco TAC 1 800 553-2447.
-

2.7.367 SFTWDOWN

Default Severity: Minor (MN), Non-Service-Affecting (NSA)

SONET Logical Object: EQPT

A Software Download in Progress alarm occurs when the TCC2/TCC2P is downloading or transferring software.

If the active and standby TCC2/TCC2Ps have the same versions of software, it takes approximately three minutes for software to be updated on a standby TCC2/TCC2P.

If the active and standby TCC2/TCC2Ps have different software versions, the transfer can take up to 30 minutes. Software transfers occur when different software versions exist on the two cards. After the transfer completes, the active TCC2/TCC2P reboots and goes into standby mode after approximately three minutes.

No action is necessary. Wait for the transfer or the software download to complete. If the alarm does not clear, log into the Technical Support Website at <http://www.cisco.com/techsupport> for more information or call Cisco TAC 1 800 553-2447.



Caution

Updating software on a standby TCC2/TCC2P can take up to 30 minutes. Wait the full time period before removing the card. Premature removal can cause flash corruption.



Note

When you upgrade a TCC2 to card to a TCC2P, the SFTWDOWN alarm can be raised and cleared more than once before the software download is complete. For example, when you remove the standby TCC2 card in Slot 11 and replace it with a TCC2P card, the SFTWDOWN alarm occurs within moments of this replacement. It can briefly clear and then raise again before it is finally cleared at the end of the upgrade process.

**Note**

SFTWDOWN is an informational alarm.

2.7.368 SF-V

Default Severity: Not Alarmed (NA), Non-Service-Affecting (NSA)

SONET Logical Objects: VT-MON, VT-TERM

An SF-V condition is similar to the “[SF \(DS1, DS3\)](#)” condition on page 2-222, but it applies to the VT layer of the SONET overhead.

Clear the SF-V Condition

-
- Step 1** Complete the “[Clear the SD \(DS1, DS3\) Condition](#)” procedure on page 2-218.
- Step 2** If the condition does not clear, log into the Technical Support Website at <http://www.cisco.com/techsupport> for more information or call Cisco TAC 1 800 553-2447.
-

2.7.369 SHELF-COMM-FAIL

For information about this alarm or condition, refer to the “Alarm Troubleshooting” chapter in the *Cisco ONS 15454 DWDM Troubleshooting Guide*. This guide discusses all DWDM alarms.

2.7.370 SH-IL-VAR-DEG-HIGH

For information about this alarm or condition, refer to the “Alarm Troubleshooting” chapter in the *Cisco ONS 15454 DWDM Troubleshooting Guide*. This guide discusses all DWDM alarms.

2.7.371 SH-IL-VAR-DEG-LOW

For information about this alarm or condition, refer to the “Alarm Troubleshooting” chapter in the *Cisco ONS 15454 DWDM Troubleshooting Guide*. This guide discusses all DWDM alarms.

2.7.372 SHUTTER-OPEN

For information about this alarm or condition, refer to the “Alarm Troubleshooting” chapter in the *Cisco ONS 15454 DWDM Troubleshooting Guide*. This guide discusses all DWDM alarms.

2.7.373 SIGLOSS

Default Severity: Major (MJ), Service-Affecting (SA)

SONET Logical Object: FCMR

DWDM Logical Objects: ESCON, FC, GE, ISC, TRUNK

The Signal Loss on Data Interface alarm is raised on FC_MR-4 card receive client ports and MXP card FC and ISC client data ports when there is a loss of signal. (Loss of Gigabit Ethernet client signal results in a “[CARLOSS \(GE\)](#)” alarm on page 2-65, not SIGLOSS.) SIGLOSS can also be raised on the MXP trunk port.

If the “[SYNCLOSS](#)” alarm on page 2-241, was previously raised on the port, the SIGLOSS alarm will demote it.

Clear the SIGLOSS Alarm

-
- Step 1** Ensure that the data port connection at the near-end card’s port of the SONET link is operational.
 - Step 2** Verify fiber continuity to the port. To verify fiber continuity, follow site practices.
 - Step 3** Check the physical port LED on the card. The port LED looks clear (that is, not lit green) if the link is not connected.
 - Step 4** If the alarm does not clear, log onto <http://www.cisco.com/techsupport> for more information or call Cisco TAC 1 800 553-2447 in order to report a Service-Affecting (SA) problem.
-

2.7.374 SNTP-HOST

Default Severity: Minor (MN), Non-Service-Affecting (NSA)

SONET Logical Object: NE

The Simple Network Timing Protocol (SNTP) Host Failure alarm indicates that an ONS 15454 serving as an IP proxy for the other ONS 15454 nodes in the ring is not forwarding SNTP information to the other nodes in the network. The forwarding failure can result from two causes: either the IP network attached to the ONS 15454 proxy node is experiencing problems, or the ONS 15454 proxy node itself is not functioning properly.

Clear the SNTP-HOST Alarm

-
- Step 1** Ping the SNTP host from a workstation in the same subnet to ensure that communication is possible within the subnet by completing the “[1.9.8 Verify PC Connection to the ONS 15454 \(ping\)](#)” procedure on page 1-119.
 - Step 2** If the ping fails, contact the network administrator who manages the IP network that supplies the SNTP information to the proxy and determine whether the network is experiencing problems, which could affect the SNTP server/router connecting to the proxy ONS 15454 system.
 - Step 3** If no network problems exist, ensure that the ONS system proxy is provisioned correctly:
 - a. In node view for the ONS 15454 serving as the proxy, click the **Provisioning > General** tabs.
 - b. Ensure that the Use NTP/SNTP Server check box is checked.
 - c. If the Use NTP/SNTP Server check box is not checked, click it.
 - d. Ensure that the Use NTP/SNTP Server field contains a valid IP address for the server.
 - Step 4** If proxy is correctly provisioned, refer to the “Timing” chapter in the *Cisco ONS 15454 Reference Manual* for more information on SNTP Host.

- Step 5** If the alarm does not clear, log into the Technical Support Website at <http://www.cisco.com/techsupport> for more information or call Cisco TAC 1 800 553-2447.
-

2.7.375 SPANLEN-OUT-OF-RANGE

For information about this alarm or condition, refer to the “Alarm Troubleshooting” chapter in the *Cisco ONS 15454 DWDM Troubleshooting Guide*. This guide discusses all DWDM alarms.

2.7.376 SPAN-SW-EAST

Default Severity: Not Alarmed (NA), Non-Service-Affecting (NSA)

SONET Logical Object: OCN

The Span Switch Is Active East Side condition occurs when a span switch occurs at the east side of a four-fiber BLSR span using a Manual Switch, APS switch, or Force Span command. The condition clears when the switch is cleared. SPAN-SW-EAST is visible on the network view Alarms, Conditions, and History tabs. The port where the Force Span was applied shows an “F” on the network view detailed circuit map.



Note

SPAN-SW-EAST is an informational condition and does not require troubleshooting.

2.7.377 SPAN-SW-WEST

Default Severity: Not Alarmed (NA), Non-Service-Affecting (NSA)

SONET Logical Object: OCN

The Span Switch Is Active West Side condition occurs when a span switch occurs at the west side of a four-fiber BLSR span using a Manual Switch, APS switch, or Force Span command. The condition clears when the switch is cleared. SPAN-SW-WEST is visible on the network view Alarms, Conditions, and History tabs. The port where the Force Span was applied shows an “F” on the network view detailed circuit map.



Note

SPAN-SW-WEST is an informational condition and does not require troubleshooting.

2.7.378 SQUELCH

Default Severity: Not Alarmed (NA), Non-Service-Affecting (NSA)

SONET Logical Object: OCN

The Ring Squelching Traffic condition occurs in a BLSR when a node that originates or terminates STS circuits fails or is isolated by multiple fiber cuts or maintenance Force Ring commands. The isolation or failure of the node disables circuits that originate or terminate on the failed node. SQUELCH conditions appear on one or both of the nodes on either side of the isolated or failed node. The [“AIS-P” condition on page 2-38](#) also appears on all nodes in the ring except the isolated node.

**Warning**

On the OC-192 card, the laser is on when the card is booted and the safety key is in the on position (labeled 1). The port does not have to be in service for the laser to be on. The laser is off when the safety key is off (labeled 0). Statement 293.

**Warning**

Invisible laser radiation could be emitted from the end of the unterminated fiber cable or connector. Do not stare into the beam directly with optical instruments. Viewing the laser output with certain optical instruments (for example, eye loupes, magnifiers, and microscopes) within a distance of 100 mm could pose an eye hazard. Statement 1056

**Warning**

Use of controls, adjustments, or performing procedures other than those specified could result in hazardous radiation exposure. Statement 1057

Clear the SQUELCH Condition

**Caution**

Always use the supplied electrostatic discharge wristband when working with a powered ONS 15454. Plug the wristband cable into the ESD jack located on the lower-right edge of the shelf assembly.

Step 1

Determine the isolated node:

- a. From the View menu, choose **Go to Network View**.
- b. The grayed out node with red spans is the isolated node.

Step 2

Verify fiber continuity to the ports on the isolated node. To verify cable continuity, follow site practices.

Step 3

If fiber continuity is good, verify that the proper ports are in service:

- a. Confirm that the LED is correctly illuminated on the physical card.
A green ACT/SBY LED indicates an active card. An amber ACT/SBY LED indicates a standby card.
- b. To determine whether the OC-N port is in service, double-click the card in CTC to open the card view.
- c. Click the **Provisioning > Line** tabs.
- d. Verify that the Admin State column lists the port as IS.
- e. If the Admin State column lists the port as OOS,MT or OOS,DSBLD, click the column and choose **IS**. Click **Apply**.

**Note**

If ports managed into IS admin state are not receiving signals, the LOS alarm is either raised or remains, and the port service state transitions to OOS-AU,FLT.

Step 4

If the correct ports are in service, use an optical test set to verify that a valid signal exists on the line. For specific procedures to use the test set equipment, consult the manufacturer. Test the line as close to the receiving card as possible.

Step 5

If the signal is valid, verify that the power level of the optical signal is within the optical card receiver specifications. Refer to the *Cisco ONS 15454 Reference Manual* for card specifications.

- Step 6** If the receiver levels are good, ensure that the optical transmit and receive fibers are connected properly.
- Step 7** If the connectors are good, complete the [“Physically Replace a Traffic Card” procedure on page 2-274](#) for the OC-N card.
- Step 8** If the condition does not clear, log into the Technical Support Website at <http://www.cisco.com/techsupport> for more information or call Cisco TAC 1 800 553-2447.

2.7.379 SQUELCHED

Default Severity: Not Alarmed (NA), Non-Service-Affecting (NSA)

SONET Logical Object: OCN

DWDM Logical Objects: 2R, ESCON, FC, GE, ISC, TRUNK

The Client Signal Squelched condition is raised by a TXP_MR_10G, TXP_MR_10E, TXP_MR_2.5G, TXPP_MR_2.5G, MXP_2.5G_10G, MXP_2.5G_10E, MXP_MR_2.5G, or MXPP_MR_2.5G card.

The condition can be raised in the following situations:

- An MXP or TXP client facility detects that an upstream receive facility has experienced a loss of signal (such as an Ethernet CARLOSS, DWDM SIGLOSS, or optical LOS). In response, the facility’s transmit is turned off (SQUELCHED). The upstream receive facilities are the trunk receive on the same card as the client, as well as the client receive on the card at the other end of the trunk span.
- The client will squelch if the upstream trunk receive (on the same card) experiences the [“SIGLOSS” alarm on page 2-226](#), the [“CARLOSS \(FC\)” alarm on page 2-63](#), the [“CARLOSS \(GE\)” alarm on page 2-65](#), the [“CARLOSS \(ISC\)” alarm on page 2-65](#), the [“LOS \(2R\)” alarm on page 2-158](#), the [“LOS \(ESCON\)” alarm on page 2-164](#), the [“LOS \(ISC\)” alarm on page 2-165](#), or the [“LOS \(TRUNK\)” alarm on page 2-167](#). In some transparent modes, the client is squelched if the trunk detects the [“AIS” alarm on page 2-37](#) or the [“TIM” alarm on page 2-245](#).
- The client will squelch if the upstream client receive (on the card at the other end of the DWDM span) experiences the [“SIGLOSS” alarm on page 2-226](#), the [“CARLOSS \(FC\)” alarm on page 2-63](#), the [“CARLOSS \(GE\)” alarm on page 2-65](#), the [“CARLOSS \(ISC\)” alarm on page 2-65](#), the [“LOS \(2R\)” alarm on page 2-158](#), the [“LOS \(ESCON\)” alarm on page 2-164](#), the [“LOS \(ISC\)” alarm on page 2-165](#), or the [“LOS \(TRUNK\)” alarm on page 2-167](#).

In an example situation, an upstream MXP_2.5G_10G client port receive experiences a “loss of light,” and this port raises CARLOSS, SIGLOSS, or LOS (determined by the payload type) locally. The port also sends client signal fail to its downstream card. The downstream card raises a [“GFP-CSF” alarm on page 2-117](#), turns off the client transmit laser, and raises the SQUELCHED condition.

The local client raises SQUELCHED if it also raises one of the following alarms for the client, all of which are signalled by the upstream node:

- [2.7.149 GFP-CSF, page 2-117](#)
- [2.7.152 GFP-LFD, page 2-119](#)
- [2.7.153 GFP-NO-BUFFERS, page 2-120](#)
- [2.7.150 GFP-DE-MISMATCH, page 2-118](#)
- [2.7.151 GFP-EX-MISMATCH, page 2-119](#)
- [2.7.286 ODUK-1-AIS-PM, page 2-190](#)
- [2.7.287 ODUK-2-AIS-PM, page 2-190](#)

- 2.7.288 ODUK-3-AIS-PM, page 2-190
- 2.7.289 ODUK-4-AIS-PM, page 2-190

On the MXP_MR_10G, the local client raises a SQUELCHED condition if the upstream client detects one of the following alarms. Note that no corresponding local alarm is raised to indicate which of these conditions is present upstream.

- LOS for the clients including the “LOS (2R)” alarm on page 2-158, the “LOS (ESCON)” alarm on page 2-164, and the “LOS (ISC)” alarm on page 2-165
- CARLOSS for the clients including the “CARLOSS (FC)” alarm on page 2-63, the “CARLOSS (GE)” alarm on page 2-65, and the “CARLOSS (ISC)” alarm on page 2-65.

The local client raises a SQUELCHED condition if the local trunk raises one of the following alarms:

- 2.7.305 OTUK-AIS, page 2-193
- 2.7.308 OTUK-LOF, page 2-193
- 2.7.226 LOS (TRUNK), page 2-167
- 2.7.311 OTUK-TIM, page 2-193 (squelching enabled)
- 2.7.290 ODUK-AIS-PM, page 2-190
- 2.7.292 ODUK-LCK-PM, page 2-190
- 2.7.296 ODUK-TIM-PM, page 2-191 (squelching enabled)
- 2.7.411 TIM, page 2-245 (for the OC-N, squelching enabled)
- 2.7.203 LOF (OCN), page 2-152
- 2.7.224 LOS (OCN), page 2-165
- 2.7.56 CARLOSS (TRUNK), page 2-67
- 2.7.441 WVL-MISMATCH, page 2-260 (client or trunk)

When troubleshooting the SQUELCHED condition locally, look for failures progressing upstream in the following order. (If you are troubleshooting this alarm remotely, reverse the order of progress.)

- Local client alarms, as above
- Local trunk alarms, as above
- Remote (upstream) client receive alarms, as above

**Note**

If you see a SQUELCHED condition on the trunk, this can only be caused by a transponder (TXP) card.

**Note**

For more information about MXP or TXP cards, refer to the *Cisco ONS 15454 DWDM Reference Manual*.

Clear the SQUELCHED Condition

- Step 1** If the object is reported against any object besides ESCON, determine whether the remote node and local node reports and LOF or the LOS alarm (for the client trunk, as listed above). If it does, turn to the relevant section in this chapter and complete the troubleshooting procedure.

- Step 2** If no LOF or LOS is reported, determine whether any other listed remote node or local node conditions as listed above has occurred. If so, turn to the relevant section of this chapter and complete the troubleshooting procedure.
- Step 3** If none of these alarms is reported, determine whether the local port reporting the SQUELCHED condition is in loopback. (You will see LPBKFACILITY or LPBKTERMINAL condition for this particular client type in the Condition window.) If it is in loopback, complete the following steps:
- Double-click the client card to open the card view.
 - Click the **Maintenance > Loopback > Port** tabs.
 - If the port Admin State column says OOS,MT or OOS,DSBLD, click the cell to highlight it and choose **IS** from the drop-down list. Changing the state to IS also clears any loopback provisioned on the port.
-  **Note** If ports managed into IS admin state are not receiving signals, the LOS alarm is either raised or remains, and the port service state transitions to OOS-AU,FLT.
- Step 4** If the condition does not clear, log into the Technical Support Website at <http://www.cisco.com/techsupport> for more information or call Cisco TAC 1 800 553-2447.

2.7.380 SQM

Default Severity: Critical (CR), Service-Affecting (SA) for STSTRM; Major (MJ), Service-Affecting (SA) for VT-TERM

SONET Logical Objects: STSTRM, VT-TERM

The Sequence Mismatch alarm is a virtual concatenated (VCAT) member alarm. (VCAT member circuits are independent circuits that are concatenated from different time slots into a higher-rate signal.) The alarm occurs when the expected sequence numbers of VCAT members do not match the received sequence numbers.

Clear the SQM Alarm

- Step 1** For the errored circuit, complete the “[Delete a Circuit](#)” procedure on page 2-276.
- Step 2** Recreate the circuit using the “Create Circuits and VT Tunnels” chapter of the *Cisco ONS 15454 Procedure Guide*.
- Step 3** If the alarm does not clear, log into the Technical Support Website at <http://www.cisco.com/techsupport> for more information or call Cisco TAC 1 800 553-2447 in order to report a Service-Affecting (SA) problem.

2.7.381 SSM-DUS

Default Severity: Not Alarmed (NA), Non-Service-Affecting (NSA)

SONET Logical Objects: BITS, DS1, E1, OCN

DWDM Logical Object: TRUNK

The Synchronization Status (SSM) Message Quality Changed to Do Not Use (DUS) condition occurs when the synchronization status message (SSM) quality level degrades to DUS or is manually changed to DUS.

The signal is often manually changed to DUS to prevent timing loops from occurring. Sending a DUS prevents the timing from being reused in a loop. The DUS signal can also be sent for line maintenance testing.



Note

SSM-DUS is an informational condition and does not require troubleshooting.

2.7.382 SSM-FAIL

Single Failure Default Severity: Minor (MN), Non-Service-Affecting (NSA); Double Failure Default Severity: Major (MJ), Service-Affecting (SA)

SONET Logical Objects: BITS, DS1, E1, OCN

DWDM Logical Object: TRUNK

The SSM Failed alarm occurs when the synchronization status messaging received by the ONS 15454 fails. The problem is external to the ONS 15454. This alarm indicates that although the ONS 15454 is set up to receive SSM, the timing source is not delivering valid SSM messages.

Clear the SSM-FAIL Alarm

-
- Step 1** Verify that SSM is enabled on the external timing source.
- Step 2** If timing is enabled, use an optical test set to determine that the external timing source is delivering SSM. For specific procedures to use the test set equipment, consult the manufacturer.
- Step 3** If the alarm does not clear, log into the Technical Support Website at <http://www.cisco.com/techsupport> for more information or call Cisco TAC 1 800 553-2447.
-

2.7.383 SSM-LNC

For information about this alarm or condition, refer to the “Alarm Troubleshooting” chapter in the *Cisco ONS 15454 DWDM Troubleshooting Guide*. This guide discusses all DWDM alarms.

SONET Logical Objects: BITS, NE-SREF, OCN

DWDM Logical Object: TRUNK

The SSM Local Node Clock (LNC) Traceable condition occurs on MXP trunk ports when the SSM (S1) byte of the SONET overhead multiplexing section has been changed to signify that the line or BITS timing source is the LNC.



Note

SSM-LNC is an informational condition and does not require troubleshooting.

2.7.384 SSM-OFF

Default Severity: Not Alarmed (NA), Non-Service-Affecting (NSA)

SONET Logical Objects: BITS, DS1, E1, OCN

DWDM Logical Object: TRUNK

The SSM Off condition applies to references used for timing the node. It occurs when the SSM for the reference has been turned off. The node is set up to receive SSM, but the timing source is not delivering SSM messages.

Clear the SSM-OFF Condition

-
- Step 1** Complete the “[Clear the SSM-FAIL Alarm](#)” procedure on page 2-233.
- Step 2** If the condition does not clear, log into the Technical Support Website at <http://www.cisco.com/techsupport> for more information or call Cisco TAC 1 800 553-2447.
-

2.7.385 SSM-PRC

For information about this alarm or condition, refer to the “Alarm Troubleshooting” chapter in the *Cisco ONS 15454 DWDM Troubleshooting Guide*. This guide discusses all DWDM alarms.

SONET Logical Objects: BITS, NE-SREF, OCN

DWDM Logical Object: TRUNK

The SSM Primary Reference Clock (PRC) Traceable condition occurs when the SONET transmission level for an MXP trunk port is PRC.



Note

SSM-PRC is an informational condition and does not require troubleshooting.

2.7.386 SSM-PRS

Default Severity: Not Alarmed (NA), Non-Service-Affecting (NSA)

SONET Logical Objects: BITS, DS1, E1, NE-SREF, OCN

DWDM Logical Object: TRUNK

The SSM Primary Reference Source (PRS) Traceable condition occurs when the SSM transmission level is changed to Stratum 1 Traceable.



Note

SSM-PRS is an informational condition and does not require troubleshooting.

2.7.387 SSM-RES

Default Severity: Not Alarmed (NA), Non-Service-Affecting (NSA)

SONET Logical Objects: BITS, DS1, E1, NE-SREF, OCN

DWDM Logical Object: TRUNK

The SSM Reserved (RES) For Network Synchronization Use condition occurs when the synchronization message quality level is changed to RES.

**Note**

SSM-RES is an informational condition and does not require troubleshooting.

2.7.388 SSM-SDH-TN

The SSM-SDH-TN condition is not used in this platform in this release. It is reserved for development.

2.7.389 SSM-SETS

The SSM-SETS condition is not used in this platform in this release. It is reserved for development.

2.7.390 SSM-SMC

Default Severity: Not Alarmed (NA), Non-Service-Affecting (NSA)

SONET Logical Objects: BITS, DS1, E1, NE-SREF, OCN

DWDM Logical Object: TRUNK

The SSM SONET Minimum Clock (SMC) Traceable condition occurs when the synchronization message quality level changes to SMC. The login node does not use the clock because the node cannot use any reference beneath its internal level, which is ST3.

**Note**

SSM-SMC is an informational condition and does not require troubleshooting.

2.7.391 SSM-ST2

Default Severity: Not Alarmed (NA), Non-Service-Affecting (NSA)

SONET Logical Objects: BITS, DS1, E1, NE-SREF, OCN

DWDM Logical Object: TRUNK

The SSM Stratum 2 (ST2) Traceable condition occurs when the synchronization message quality level is changed to ST2.

**Note**

SSM-ST2 is an informational condition and does not require troubleshooting.

2.7.392 SSM-ST3

Default Severity: Not Alarmed (NA), Non-Service-Affecting (NSA)

SONET Logical Objects: BITS, DS1, E1, NE-SREF, OCN

DWDM Logical Object: TRUNK

The SSM Stratum 3 (ST3) Traceable condition occurs when the synchronization message quality level is changed to ST3.

**Note**

SSM-ST3 is an informational condition and does not require troubleshooting.

2.7.393 SSM-ST3E

Default Severity: Not Alarmed (NA), Non-Service-Affecting (NSA)

SONET Logical Objects: BITS, DS1, E1, NE-SREF, OCN

DWDM Logical Object: TRUNK

The SSM Stratum 3E (ST3E) Traceable condition indicates that the synchronization message quality level is changed to ST3E from a lower level of synchronization. SSM-ST3E is a Generation 2 SSM and is used for Generation 1.

**Note**

SSM-ST3E is an informational condition and does not require troubleshooting.

2.7.394 SSM-ST4

Default Severity: Not Alarmed (NA), Non-Service-Affecting (NSA)

SONET Logical Objects: BITS, DS1, E1, NE-SREF, OCN

DWDM Logical Object: TRUNK

The SSM Stratum 4 (ST4) Traceable condition occurs when the synchronization message quality level is lowered to ST4. The message quality is not used because it is below ST3.

**Note**

SSM-ST4 is an informational condition and does not require troubleshooting.

2.7.395 SSM-STU

Default Severity: Not Alarmed (NA), Non-Service-Affecting (NSA)

SONET Logical Objects: BITS, DS1, E1, NE-SREF, OCN

DWDM Logical Object: TRUNK

The SSM Synchronization Traceability Unknown (STU) condition occurs when the reporting node is timed to a reference that does not support SSM, but the ONS 15454 has SSM support enabled. SSM-STU can also occur if the timing source is sending out SSM messages but SSM is not enabled on the ONS 15454.

Clear the SSM-STU Condition

-
- Step 1** In node view, click the **Provisioning > Timing > BITS Facilities** tabs.
- Step 2** Complete one of the following depending upon the status of the Sync Messaging Enabled check box:
- If the **Sync. Messaging Enabled** check box for the BITS source is checked, uncheck the box.
 - If the **Sync. Messaging Enabled** check box for the BITS source is not checked, check the box.
- Step 3** Click **Apply**.
- Step 4** If the condition does not clear, log into the Technical Support Website at <http://www.cisco.com/techsupport> for more information or call Cisco TAC 1 800 553-2447.
-

2.7.396 SSM-TNC

Default Severity: Not Alarmed (NA), Non-Service-Affecting (NSA)

SONET Logical Objects: BITS, NE-SREF, OCN

DWDM Logical Object: TRUNK

The SSM Transit Node Clock (TNC) Traceable condition occurs when the synchronization message quality level is changed to TNC.



Note

SSM-TNC is an informational condition and does not require troubleshooting.

2.7.397 STS-SQUELCH-L

Default Severity: Not Alarmed (NA), Non-Service-Affecting (NSA)

SONET Logical Object: OCN

The Ring is Squelching STS traffic condition is raised on an OC-N facility. If the node failure scenario includes the source or destination node, then switching the nodes will squelch all the STSs that originate from or destinate to the failure node. The condition resolves when the node is no longer failing.

This condition has an NA severity by default. However, the condition indicates that traffic is squelched due to node failure, that is, traffic outage. Traffic outage can be caused by different problems, such as multiple LOS alarms, AIS-L, or node power outage. STS-SQUELCH-L is symptomatic and indicates that the user must investigate which node in a ring is being isolated and what is causing the node isolation.



Note

STS-SQUELCH-L is an informational condition.

2.7.398 SW-MISMATCH

Default Severity: Not Alarmed (NA), Non-Service-Affecting (NSA)

SONET Logical Object: EQPT

The Software Mismatch condition occurs during software upgrade when there is a mismatch between software versions. The card connecting to the TCC2/TCC2P is running an older version than the TCC2/TCC2P is.

Clear the SW-MISMATCH Condition

-
- Step 1** Complete the [“Reset a Traffic Card in CTC” procedure on page 2-271](#) for the errored card.
 - Step 2** If the condition does not clear, log into the Technical Support Website at <http://www.cisco.com/techsupport> for more information or call Cisco TAC 1 800 553-2447.
-

2.7.399 SWMTXMOD-PROT

Default Severity: Critical (CR), Service-Affecting (SA)

SONET Logical Object: EQPT

The Switching Matrix Module Failure on Protect Slot alarm is raised by the Slot 10 cross connect card if this card is active (ACT). Any kind of cross-connect card can raise this alarm. (Two exceptions are given in the following paragraph.) SWMTXMOD-PROT occurs when a logic component internal to the Slot 10 cross connect is out of frame (OOF) with a traffic card in the system. In this case, the alarm is raised against the traffic card slot.

The XC-VXC-10G card can raise this alarm (in Slot 10) whether it is ACT or standby (SBY). The XCVT card can raise SWMTXMOD-PROT against itself if the cross-connect card is OOF with a second logic component on the same cross connect card.

Clear the SWMTXMOD-PROT Alarm

-
- Step 1** Complete the [“Reset a Traffic Card in CTC” procedure on page 2-271](#) for the Slot 10 card. For the LED behavior, see the [“2.8.2 Typical Traffic Card LED Activity During Reset” section on page 2-260](#).
 - Step 2** Verify that the reset is complete and error-free and that no new related alarms appear in CTC. A green ACT/SBY LED indicates an active card. An amber ACT/SBY LED indicates a standby card.
 - Step 3** If the alarm does not clear, complete the [“Remove and Reinsert \(Reseat\) Any Card” procedure on page 2-274](#) for the Slot 10 cross-connect card.
 - Step 4** Complete the [“Side Switch the Active and Standby Cross-Connect Cards” procedure on page 2-272](#).



Note After the active cross-connect card goes into standby mode, the original standby slot becomes active. The former standby card ACT/SBY LED becomes green.

- Step 5** If the alarm does not clear, log into the Technical Support Website at <http://www.cisco.com/techsupport> for more information or call Cisco TAC 1 800 553-2447 in order to report a Service-Affecting (SA) problem.
-

2.7.400 SWMTXMOD-WORK

Default Severity: Critical (CR), Service-Affecting (SA)

SONET Logical Object: EQPT

The Switching Matrix Module Failure on Working Slot alarm is raised by the Slot 8 cross connect card if this card is active (ACT). Any kind of cross-connect card can raise this alarm. (Two exceptions are given in the following paragraph.) SWMTXMOD-WORK occurs when a logic component internal to the Slot 8 cross connect is OOF with a traffic card in the system. In this case, the alarm is raised against the traffic card slot.

The XC-VXC-10G card can raise this alarm (in Slot 8) whether it is ACT or standby (SBY). The XCVT card can raise SWMTXMOD-WORK against itself if the cross-connect card is OOF with a second logic component on the same cross connect card.

Clear the SWMTXMOD-WORK Alarm

-
- Step 1** Complete the [“Reset a Traffic Card in CTC” procedure on page 2-271](#) for the Slot 8 card. For LED behavior, see the [“2.8.2 Typical Traffic Card LED Activity During Reset” section on page 2-260](#).
 - Step 2** Verify that the reset is complete and error-free and that no new related alarms appear in CTC. A green ACT/SBY LED indicates an active card. An amber ACT/SBY LED indicates a standby card.
 - Step 3** If the alarm does not clear, complete the [“Remove and Reinsert \(Reseat\) Any Card” procedure on page 2-274](#) for the Slot 8 cross-connect card.
 - Step 4** Complete the [“Side Switch the Active and Standby Cross-Connect Cards” procedure on page 2-272](#).



Note After the active cross-connect card goes into standby mode, the original standby slot becomes active. The former standby card ACT/SBY LED becomes green.

- Step 5** If the alarm does not clear, log into the Technical Support Website at <http://www.cisco.com/techsupport> for more information or call Cisco TAC 1 800 553-2447 in order to report a Service-Affecting (SA) problem.
-

2.7.401 SWTOPRI

Default Severity: Not Alarmed (NA), Non-Service-Affecting (NSA)

SONET Logical Objects: EXT-SREF, NE-SREF

The Synchronization Switch to Primary Reference condition occurs when the ONS 15454 switches to the primary timing source (reference 1). The ONS 15454 uses three ranked timing references. The timing references are typically two BITS-level or line-level sources and an internal reference.



Note SWTOPRI is an informational condition and does not require troubleshooting.

2.7.402 SWTOSEC

Default Severity: Not Alarmed (NA), Non-Service-Affecting (NSA)

SONET Logical Objects: EXT-SREF, NE-SREF

The Synchronization Switch to Secondary Reference condition occurs when the ONS 15454 has switched to a secondary timing source (reference 2).

Clear the SWTOSEC Condition

-
- Step 1** To clear the condition, clear alarms related to failures of the primary source, such as the “[SYNCPRI](#)” alarm on page 2-242.
- Step 2** If the condition does not clear, log into the Technical Support Website at <http://www.cisco.com/techsupport> for more information or call Cisco TAC 1 800 553-2447.
-

2.7.403 SWTOTHIRD

Default Severity: Not Alarmed (NA), Non-Service-Affecting (NSA)

SONET Logical Objects: EXT-SREF, NE-SREF

The Synchronization Switch to Third Reference condition occurs when the ONS 15454 has switched to a third timing source (reference 3).

Clear the SWTOTHIRD Condition

-
- Step 1** To clear the condition, clear alarms related to failures of the primary source, such as the “[SYNCPRI](#)” alarm on page 2-242 or the “[SYNCSEC](#)” alarm on page 2-242.
- Step 2** If the condition does not clear, log into the Technical Support Website at <http://www.cisco.com/techsupport> for more information or call Cisco TAC 1 800 553-2447.
-

2.7.404 SYNC-FREQ

Default Severity: Not Alarmed (NA), Non-Service-Affecting (NSA)

SONET Logical Objects: BITS, DS1, E1, OCN

DWDM Logical Object: TRUNK

The Synchronization Reference Frequency Out of Bounds condition is reported against any reference that is out of the bounds for valid references. The login node fails the reference and chooses another internal or external reference to use.

Clear the SYNC-FREQ Condition

Step 1 Use an optical test set to verify the timing frequency of the line or BITS timing source and ensure that it falls within the proper frequency. For specific procedures to use the test set equipment, consult the manufacturer.

For BITS, the proper timing frequency range is approximately –15 PPM to 15 PPM. For optical line timing, the proper frequency range is approximately –16 PPM to 16 PPM.

Step 2 If the reference source frequency is not outside of bounds, complete the “[Physically Replace a Traffic Card](#)” procedure on page 2-274 for the TCC2/TCC2P.



Note It takes up to 30 minutes for the TCC2/TCC2P to transfer the system software to the newly installed TCC2/TCC2P. Software transfer occurs in instances where different software versions exist on the two cards. When the transfer completes, the active TCC2/TCC2P reboots and goes into standby mode after approximately three minutes.

Step 3 If the SYNC-FREQ condition continues to report after replacing the TCC2/TCC2P, log into the Technical Support Website at <http://www.cisco.com/techsupport> for more information or call Cisco TAC 1 800 553-2447.

2.7.405 SYNCLOSS

Default Severity: Major (MJ), Service-Affecting (SA)

SONET Logical Object: FCMR

DWDM Logical Objects: FC, GE, ISC, TRUNK

The Loss of Synchronization on Data Interface alarm is raised on FC_MR-4 client ports and MXP cards client or trunk ports when there is a loss of signal synchronization on the port. This alarm is demoted by the SIGLOSS alarm.

Clear the SYNCLOSS Alarm

Step 1 Ensure that the data port connection at the near-end card's port of the SONET link is operational.

Step 2 Verify fiber continuity to the port. To do this follow site practices.

Step 3 View the physical port LED to determine whether the alarm has cleared:

- If the LED is green, the alarm has cleared.
- If the port LED is clear (that is, not illuminated green), the link is not connected and the alarm has not cleared.
- If the LED is red, this indicates that the fiber is pulled.

Step 4 If the alarm does not clear, log into the Technical Support Website at <http://www.cisco.com/techsupport> for more information or call Cisco TAC 1 800 553-2447 to report a Service-Affecting (SA) problem.

2.7.406 SYNCPRI

Default Severity: Minor (MN), Non-Service-Affecting (NSA) for EXT-SREF;Major (MJ), Service-Affecting (SA) for NE-SREF

SONET Logical Objects: EXT-SREF, NE-SREF

A Loss of Timing on Primary Reference alarm occurs when the ONS 15454 loses the primary timing source (reference 1). The ONS 15454 uses three ranked timing references. The timing references are typically two BITS-level or line-level sources and an internal reference. If SYNCPRI occurs, the ONS 15454 should switch to its secondary timing source (reference 2). Switching to the secondary timing source also triggers the “[SWTOSEC](#)” alarm on page 2-240.



Note

The SYNCPRI alarm will be escalated to Major (MJ), Service-Affecting if no other valid references (SYNCSEC, SYNCTHIRD) are available. If any other reference are available then SYNCPRI gets raised as Minor (MN), non service affecting.

Clear the SYNCPRI Alarm

-
- Step 1** In node view, click the **Provisioning > Timing > General** tabs.
 - Step 2** Verify the current configuration for REF-1 of the NE Reference.
 - Step 3** If the primary timing reference is a BITS input, complete the “[Clear the LOS \(BITS\) Alarm](#)” procedure on page 2-158.
 - Step 4** If the primary reference clock is an incoming port on the ONS 15454, complete the “[Clear the LOS \(OCN\) Alarm](#)” procedure on page 2-166.
 - Step 5** If the condition does not clear, log into the Technical Support Website at <http://www.cisco.com/techsupport> for more information or call Cisco TAC 1 800 553-2447.
-

2.7.407 SYNCSEC

Default Severity: Minor (MN), Non-Service-Affecting (NSA)

SONET Logical Objects: EXT-SREF, NE-SREF

A Loss of Timing on Secondary Reference alarm occurs when the ONS 15454 loses the secondary timing source (reference 2). If SYNCSEC occurs, the ONS 15454 should switch to a third timing source (reference 3) to obtain valid timing for the ONS 15454. Switching to a third timing source also triggers the “[SWTOTHIRD](#)” alarm on page 2-240.



Note

The severity of SYNCSEC alarm is dependent on the alarm profile it is associated with. If the alarm profile it is associated with is Major (MJ), then this condition is raised as MJ, service affecting, even if alternate source of references are available.

Clear the SYNCSEC Alarm

-
- Step 1** In node view, click the **Provisioning > Timing > General** tabs.
 - Step 2** Verify the current configuration of REF-2 for the NE Reference.
 - Step 3** If the secondary reference is a BITS input, complete the [“Clear the LOS \(BITS\) Alarm” procedure on page 2-158](#).
 - Step 4** Verify that the BITS clock is operating properly.
 - Step 5** If the secondary timing source is an incoming port on the ONS 15454, complete the [“Clear the LOS \(OCN\) Alarm” procedure on page 2-166](#).
 - Step 6** If the alarm does not clear, log into the Technical Support Website at <http://www.cisco.com/techsupport> for more information or call Cisco TAC 1 800 553-2447.
-

2.7.408 SYNCTHIRD

Default Severity: Minor (MN), Non-Service-Affecting (NSA)

SONET Logical Objects: EXT-SREF, NE-SREF

A Loss of Timing on Third Reference alarm occurs when the ONS 15454 loses the third timing source (reference 3). If SYNCTHIRD occurs and the ONS 15454 uses an internal reference for source three, the TCC2/TCC2P could have failed. The ONS 15454 often reports either the [“FRNGSYNC” condition on page 2-115](#) or the [“HLDOVRSYNC” condition on page 2-127](#) after a SYNCTHIRD alarm.



Note

The severity of SYNCTHIRD alarm is dependent on the alarm profile it is associated with. If the alarm profile it is associated with is Major (MJ), then this condition is raised as MJ, service affecting, even if alternate source of references are available.

Clear the SYNCTHIRD Alarm

-
- Step 1** In node view, click the **Provisioning > Timing > General** tabs.
 - Step 2** Verify that the current configuration of REF-3 for the NE Reference. For more information about references, refer to the “Timing” chapter in the *Cisco ONS 15454 Reference Manual*.
 - Step 3** If the third timing source is a BITS input, complete the [“Clear the LOS \(BITS\) Alarm” procedure on page 2-158](#).
 - Step 4** If the third timing source is an incoming port on the ONS 15454, complete the [“Clear the LOS \(OCN\) Alarm” procedure on page 2-166](#).



Caution

Always use the supplied electrostatic discharge wristband when working with a powered ONS 15454. Plug the wristband cable into the ESD jack located on the lower-right edge of the shelf assembly.

- Step 5** If the third timing source uses the internal ONS 15454 timing, complete the [“Reset an Active TCC2/TCC2P Card and Activate the Standby Card” procedure on page 2-271](#).
Wait ten minutes to verify that the card you reset completely reboots and becomes the standby card.

- Step 6** If the reset card has not rebooted successfully, or the alarm has not cleared, call Cisco TAC 1 800 553-2447. If the Cisco TAC technician tells you to reseat the card, complete the [“Remove and Reinsert \(Reseat\) the Standby TCC2/TCC2P Card” procedure on page 2-273](#). If the Cisco TAC technician tells you to remove the card and reinstall a new one, follow the [“Physically Replace a Traffic Card” procedure on page 2-274](#).
-

2.7.409 SYSBOOT

Default Severity: Major (MJ), Service-Affecting (SA)

SONET Logical Object: NE

The System Reboot alarm indicates that new software is booting on the TCC2/TCC2P. No action is required. The alarm clears when all cards finish rebooting the new software. The reboot takes up to 30 minutes.

If the alarm does not clear, log into the Technical Support Website at <http://www.cisco.com/techsupport> for more information or call Cisco TAC 1 800 553-2447 in order to report a Service-Affecting (SA) problem.



Note

SYSBOOT is an informational alarm. It only requires troubleshooting if it does not clear.

2.7.410 TEMP-MISM

Default Severity: Not Alarmed (NA), Non-Service-Affecting (NSA)

SONET Logical Object: NE

Temperature Reading Mismatch Between Control Cards is raised when the temperature readings on the two TCC2/TCC2Ps are out of range of each other by more than some predefined difference (such as 5 degrees C). A message containing power monitoring and temperature information is exchanged between the two TCC2/TCC2Ps, allowing the values to be compared. The temperature of each TCC2/TCC2P is read from a system variable.

This condition can be caused by a clogged fan filter or by fan tray stoppage.

Clear the TEMP-MISM Condition

-
- Step 1** Complete the [“Inspect, Clean, and Replace the Reusable Air Filter” procedure on page 2-279](#).
- Step 2** If the condition does not clear, complete the [“Remove and Reinsert a Fan-Tray Assembly” procedure on page 2-280](#).
- Step 3** If the alarm does not clear, log into the Technical Support Website at <http://www.cisco.com/techsupport> for more information or call Cisco TAC 1 800 553-2447.
-

2.7.411 TIM

Default Severity: Critical (CR), Service-Affecting (SA)

SONET Logical Object: OCN

DWDM Logical Object: TRUNK

The Section TIM alarm occurs when the expected J0 section trace string does not match the received section trace string. This occurs because the data being received is not correct, and the receiving port could not be connected to the correct transmitter port.

If the alarm occurs on a port that has been operating with no alarms, the circuit path has changed due to a fiber misconnection, a TL1 routing change, or to someone entering an incorrect value in the Current Transmit String field.

TIM occurs on a port that has previously been operating without alarms if someone switches optical fibers that connect the ports. TIM is usually accompanied by other alarms, such as the “[LOS \(OCN\) alarm on page 2-165](#)” or the “[UNEQ-P alarm on page 2-253](#)”. If these alarms accompany a TIM alarm, reattach or replace the original cables/fibers to clear the alarms. If a Transmit or Expected String was changed, restore the original string.

Clear the TIM Alarm

-
- Step 1** Ensure that the physical fibers are correctly configured and attached. To do this, consult site documents. For more information about cabling the ONS 15454, refer to the “Install Cards and Fiber-Optic Cable” chapter in the *Cisco ONS 15454 Procedure Guide*.
- Step 2** If the alarm does not clear, you can compare the J0 expected and transmitted strings and, if necessary, change them:
- Log into the circuit source node and click the **Circuits** tab.
 - Select the circuit reporting the condition, then click **Edit**.
 - In the Edit Circuit window, check the **Show Detailed Circuit Map** check box and click **Apply**.
 - On the detailed circuit map, right-click the source circuit port and choose **Edit J0 Path Trace (port)** from the shortcut menu.
 - Compare the Current Transmit String and the Current Expected String entries in the Edit J0 Path Trace dialog box.
 - If the strings differ, correct the Transmit or Expected strings and click **Apply**.
 - Click **Close**.
- Step 3** If the alarm does not clear, ensure that the signal has not been incorrectly routed. (Although the ONS 15454 routes circuits automatically, the circuit route could have been changed using TL1.) If necessary, manually correct the routing using TL1. For instructions, refer to the *Cisco ONS SONET TL1 Reference Guide* and the *Cisco ONS SONET TL1 Command Guide*.
- Step 4** If the alarm does not clear, log into the Technical Support Website at <http://www.cisco.com/techsupport> for more information or call Cisco TAC 1 800 553-2447 in order to report a Service-Affecting (SA) problem if necessary.
-

2.7.412 TIM-MON

Default Severity: Minor (MN), Non-Service-Affecting (NSA)

SONET Logical Object: OCN

DWDM Logical Object: TRUNK

The TIM Section Monitor TIM alarm is similar to the “TIM-P” alarm on page 2-246, but it applies to TXP_MR_10G, TXP_MR_2.5G, TXPP_MR_2.5G, TXP_MR_10E, and MXP_2.5G_10G cards when they are configured in transparent mode. (In transparent termination mode, all SONET overhead bytes are passed through from client ports to the trunk ports or from trunk ports to client ports.)



Note

For more information about MXP and TXP cards, refer to the *Cisco ONS 15454 DWDM Reference Manual*.

Clear the TIM-MON Alarm

-
- Step 1** Complete the “Clear the TIM-P Alarm” procedure on page 2-246.
 - Step 2** If the alarm does not clear, log into the Technical Support Website at <http://www.cisco.com/techsupport> for more information or call Cisco TAC 1 800 553-2447.
-

2.7.413 TIM-P

Default Severity: Critical (CR), Service-Affecting (SA) for STSTRM; Default Severity: Minor (MN), Non-Service-Affecting (NSA) for STSMON

SONET Logical Objects: STSMON, STSTRM

The TIM Path alarm occurs when the expected path trace string does not match the received path trace string. Path Trace Mode must be set to Manual or Auto for the TIM-P alarm to occur.

In manual mode at the Path Trace window, the user types the expected string into the Current Expected String field for the receiving port. The string must match the string typed into the Transmit String field for the sending port. If these fields do not match, the login node raises the TIM-P alarm. In Auto mode on the receiving port, the card sets the expected string to the value of the received string. If the alarm occurs on a port that has been operating with no alarms, the circuit path has changed or someone entered a new incorrect value into the Current Transmit String field. Complete the following procedure to clear either instance.

Clear the TIM-P Alarm

-
- Step 1** Complete the “Clear the TIM Alarm” procedure on page 2-245. (The option will say “Edit J1 Path Trace” rather than “Edit J0 Path Trace.”)
 - Step 2** If the alarm does not clear, log into the Technical Support Website at <http://www.cisco.com/techsupport> for more information or call Cisco TAC 1 800 553-2447. If the alarm applies to the STSTRM object, it is Service-Affecting (SA).
-

2.7.414 TIM-S

Default Severity: Critical (CR), Service-Affecting (SA)

SONET Logical Objects: EC1, OCN

The TIM for Section Overhead alarm occurs when there is a mismatch between the expected and received J0 section overhead strings in either Manual or Auto mode.

In manual mode at the DS3/EC1-48 card Section Trace window, the user enters the expected string into the Current Expected String field for the receiving port. The string must match the string typed into the Transmit String field for the sending port. If these fields do not match, the login node raises the TIM-S alarm.

In Auto mode on the receiving port, the card sets the expected string to the value of the received string. If the alarm occurs on a port that has been operating with no alarms, the circuit path has changed or someone entered a new incorrect value into the Current Transmit String field. Complete the following procedure to clear either problem.

TIM-S also occurs on a port that has previously been operating without alarms if someone switches the cables or optical fibers that connect the ports. If TIM-S is enabled on the port, the “AIS-L” alarm on page 2-38 can be raised downstream and the “RFI-L” alarm on page 2-205 can be raised upstream.

**Note**

AIS-L and RFI-L are disabled or enabled in the **Provisioning > EC1 > Section Trace** tab **Disable AIS/RDI on TIM-S?** check box.

Clear the TIM-S Alarm

- Step 1** Double-click the DS3/EC1-48 card to open the card view.
- Step 2** Click the **Provisioning > EC1 > Section Trace** tabs.
- Step 3** Choose the port from the **Port** pull-down.
- Step 4** In the Expected area, enter the correct string into the **Current Expected String** field.
- Step 5** Click **Apply**.
- Step 6** If the alarm does not clear, log into the Technical Support Website at <http://www.cisco.com/techsupport> for more information or call Cisco TAC 1 800 553-2447. If the alarm applies to the STSTRM object, it is Service-Affecting (SA).

2.7.415 TIM-V

Default Severity: Major (MJ), Service-Affecting (SA)

SONET Logical Object: VT-TERM, VT-MON

The VT Path TIM alarm is raised on VT terminations when the J2 path trace is enabled and is mismatched with the expected trace string.

Clear the TIM-V Alarm

-
- Step 1** Complete the “[Clear the TIM Alarm](#)” procedure on page 2-245.
- Step 2** If the alarm does not clear, log into the Technical Support Website at <http://www.cisco.com/techsupport> for more information or call Cisco TAC 1 800 553-2447 to report a Service-Affecting (SA) problem.
-

2.7.416 TPTFAIL (CE100T, CE1000)

Default Severity: Major (MJ), Service-Affecting (SA)

SONET Logical Objects: CE100T, CE1000

The Transport (TPT) Layer Failure alarm for the CE-Series card indicates a break in the end-to-end Ethernet link integrity feature of the card. TPTFAIL indicates a far-end condition and not a problem with the port reporting TPTFAIL.



Note

For more information about Ethernet cards, refer to the *Cisco ONS 15454 and Cisco ONS 15454 SDH Ethernet Card Software Feature and Configuration Guide*.

Clear the TPTFAIL (CE100T, CE1000) Alarm

-
- Step 1** Complete the “[Clear the TPTFAIL \(G1000\) Alarm](#)” procedure on page 2-249.
- Step 2** If the alarm does not clear, log into the Technical Support Website at <http://www.cisco.com/techsupport> for more information or call Cisco TAC 1 800 553-2447 to report a Service-Affecting (SA) problem.
-

2.7.417 TPTFAIL (FCMR)

Default Severity: Major (MJ), Service-Affecting (SA)

SONET Logical Object: FCMR

The Transport Fail alarm is raised against a local Fibre Channel (FC) port on an FC_MR-4 card when the port receives another SONET error such as the “[AIS-P](#)” alarm on page 2-38, the “[LOP-P](#)” alarm on page 2-155; “[UNEQ-P](#)” alarm on page 2-253, the “[PLM-P](#)” alarm on page 2-196, the “[TIM-P](#)” alarm on page 2-246, the “[LOM](#)” alarm on page 2-155 (for VCAT only), or the “[SQM](#)” alarm on page 2-232 (for VCAT only).

This TPTFAIL can be raised against Fibre Channel cards if the remote FC card port is down from SIGLOSS or SYNCLOSS. In that case, the remote FC card port sends a PDI-P error code in the SONET C2 byte and signals the local FC port transmitter to turn off (thus causing the local FC port to raise the TPTFAIL alarm). A TPTFAIL can also be raised when a far-end receive fiber is pulled. This alarm can be demoted when a facility loopback is placed on the FC_MR-4 port.

Clear the TPTFAIL (FCMR) Alarm

-
- Step 1** Find and clear any path alarms applying to the port. Refer to the correct section of this chapter for trouble clearing instructions. Clearing the path alarm also clears the TPTFAIL.
- Step 2** If the alarm does not clear, log into the Technical Support Website at <http://www.cisco.com/techsupport> for more information or call Cisco TAC 1 800 553-2447 in order to report a Service-Affecting (SA) problem.
-

2.7.418 TPTFAIL (G1000)

Default Severity: Major (MJ), Service-Affecting (SA)

SONET Logical Object: G1000

The Transport Layer Failure alarm for the G-Series Ethernet card indicates a break in the end-to-end Ethernet link integrity feature of the ONS 15454 G1000-4 cards. TPTFAIL indicates a far-end condition and not a problem with the port reporting TPTFAIL.

The TPTFAIL alarm indicates a problem on either the SONET path or the remote Ethernet port that prevents the complete end-to-end Ethernet path from working. If any SONET path alarms such as the “AIS-P” alarm on page 2-38, the “LOP-P” alarm on page 2-155, the “PDI-P” alarm on page 2-194, or the “UNEQ-P” alarm on page 2-253 exist on the SONET path used by the Ethernet port, the affected port causes a TPTFAIL alarm. Also, if the far-end G1000-4 port Ethernet port is administratively disabled or it is reporting the “CARLOSS (G1000)” alarm on page 2-63, the C2 byte in the SONET path overhead indicates the “PDI-P” alarm on page 2-194, which in turn causes a TPTFAIL to be reported against the near-end port.

When a TPTFAIL alarm occurs, the near-end port is automatically disabled (transmit laser turned off). In turn, the laser shutoff can also cause the external Ethernet device attached at the near end to detect a link down and turn off its transmitter. This also causes a CARLOSS alarm to occur on the reporting port. In all cases, the source problem is either in the SONET path being used by the G1000-4 port or the far-end G1000-4 port to which it is mapped.

An occurrence of TPTFAIL on an ONS 15454 G1000-4 port indicates either a problem with the SONET path that the port is using or with the far-end G1000-4 port that is mapped to the port.



Note

For more information about Ethernet cards, refer to the *Cisco ONS 15454 and Cisco ONS 15454 SDH Ethernet Card Software Feature and Configuration Guide*.

Clear the TPTFAIL (G1000) Alarm

-
- Step 1** Clear any alarms being reported by the OC-N card on the G1000-4 circuit.
- Step 2** If no alarms are reported by the OC-N card, or if the “PDI-P” condition on page 2-194 is reported, the problem could be on the far-end G1000-4 port. Clear any alarms, such as CARLOSS, reported against the far-end port or card.

- Step 3** If the alarm does not clear, log into the Technical Support Website at <http://www.cisco.com/techsupport> for more information or call Cisco TAC 1 800 553-2447 in order to report a Service-Affecting (SA) problem.

2.7.419 TPTFAIL (ML100T, ML1000, MLFX)

Default Severity: Major (MJ), Service-Affecting (SA)

SONET Logical Objects: ML100T, ML1000, MLFX

The TPT Layer Failure alarm for the ML-Series Ethernet card indicates a break in the end-to-end packet-over-SONET (POS) link integrity feature of the ML-Series POS cards. TPTFAIL indicates a far-end condition or misconfiguration of the POS port.

The TPTFAIL alarm indicates a problem on the SONET path, a problem on the remote POS port, or a misconfiguration of the POS port that prevents the complete end-to-end POS path from working. If any SONET path alarms such as the “AIS-P” condition on page 2-38, the “LOP-P” alarm on page 2-155, the “PDI-P” condition on page 2-194, or the “UNEQ-P” alarm on page 2-253 exist on the circuit used by the POS port, the affected port could report a TPTFAIL alarm. If the far-end ML POS port is administratively disabled, it inserts an “AIS-P” condition on page 2-38 that is detected by the near-end port. The near-end port could report TPTFAIL in this event. If the POS port is misconfigured at the Cisco IOS CLI level, the misconfiguration causes the port to go down and report TPTFAIL.



Note

For more information about the ML-Series Ethernet cards, refer to the *Cisco ONS 15454 and Cisco ONS 15454 SDH Ethernet Card Software Feature and Configuration Guide*.

Clear the TPTFAIL (ML100T, ML1000, MLFX) Alarm

- Step 1** If there are no SONET alarms reported against the POS port circuit, verify that both POS ports are properly configured. Refer to the *Cisco ONS 15454 and Cisco ONS 15454 SDH Ethernet Card Software Feature and Configuration Guide* for configuration information.
- Step 2** If the “PLM-P” alarm on page 2-196 is the only one reported against the POS port circuit, verify that both POS ports are properly configured. Refer to the *Cisco ONS 15454 and Cisco ONS 15454 SDH Ethernet Card Software Feature and Configuration Guide* for configuration information.
- Step 3** If the “PDI-P” condition on page 2-194 is the only one reported against the POS port circuit and the circuit is terminated by a G-Series card, determine whether a “CARLOSS (G1000)” alarm on page 2-63 is reported against the G-Series card, and if so, complete the “Clear the CARLOSS (G1000) Alarm” procedure on page 2-63.
- Step 4** If the “AIS-P” alarm on page 2-38, the “LOP-P” alarm on page 2-155, or the “UNEQ-P” alarm on page 2-253 is present, clear those alarms using the procedures in those sections.
- Step 5** If the alarm does not clear, log into the Technical Support Website at <http://www.cisco.com/techsupport> for more information or call Cisco TAC 1 800 553-2447 in order to report a Service-Affecting (SA) problem.

2.7.420 TRMT

Default Severity: Major (MJ), Service-Affecting (SA)

SONET Logical Objects: DS1, E1

A Missing Transmitter alarm occurs when there is a transmit failure on the ONS 15454 DS-1 card because of an internal hardware failure. The card must be replaced.

Clear the TRMT Alarm

-
- Step 1** Complete the “[Physically Replace a Traffic Card](#)” procedure on page 2-274 for the reporting DS-1 card.
- Step 2** If the alarm does not clear, log into the Technical Support Website at <http://www.cisco.com/techsupport> for more information or call Cisco TAC 1 800 553-2447 in order to report a Service-Affecting (SA) problem.
-

2.7.421 TRMT-MISS

Default Severity: Major (MJ), Service-Affecting (SA)

SONET Logical Objects: DS1, E1

A Facility Termination Equipment Transmitter Missing alarm occurs when the facility termination equipment detects an incorrect amount of impedance on its backplane connector. Incorrect impedance is detected when a transmit cable is missing on the DS-1 port or the backplane does not match the inserted card. For example, an SMB connector or a BNC connector could be connected to a DS-1 card instead of a DS-3 card.



Note

DS-1s are four-wire circuits and need a positive and negative connection for both transmit and receive.

Clear the TRMT-MISS Alarm

-
- Step 1** Verify that the device attached to the DS-1 port is operational.
- Step 2** If the device is operational, verify that the cabling is securely connected.
- Step 3** If the cabling is secure, verify that the pinouts are correct.
- Step 4** If the pinouts are correct, replace the transmit cable.
- Step 5** If the alarm does not clear, log into the Technical Support Website at <http://www.cisco.com/techsupport> for more information or call Cisco TAC 1 800 553-2447 in order to report a Service-Affecting (SA) problem.
-

2.7.422 TX-AIS

Default Severity: Not Reported (NR), Non-Service-Affecting (NSA)

SONET Logical Objects: DS1, DS3, E1

The (TX) Transmit Direction AIS condition is raised by the ONS 15454 backplane when it receives a far-end DS-1 LOS.

Clear the TX-AIS Condition

-
- Step 1** Determine whether there are alarms on the downstream nodes and equipment, especially the “[LOS \(OCN\)](#)” alarm on page 2-165, or OOS ports.
 - Step 2** Clear the downstream alarms using the applicable procedures in this chapter.
 - Step 3** If the condition does not clear, log into the Technical Support Website at <http://www.cisco.com/techsupport> for more information or call Cisco TAC 1 800 553-2447.
-

2.7.423 TX-LOF

Default Severity: Not Reported (NR), Non-Service-Affecting (NSA)

SONET Logical Objects: DS1, E1

The Transmit Direction LOF condition is transmitted by the backplane when it receives a DS-1 TX-LOF. This alarm is raised only at the transmit (egress) side.

Clear the TX-LOF Condition

-
- Step 1** Complete the “[Clear the LOF \(DS1\) Alarm](#)” procedure on page 2-149.
 - Step 2** If the condition does not clear, log into the Technical Support Website at <http://www.cisco.com/techsupport> for more information or call Cisco TAC 1 800 553-2447.
-

2.7.424 TX-RAI

Default Severity: Not Alarmed (NA), Non-Service-Affecting (NSA)

SONET Logical Objects: DS1, DS3, E1

The Transmit Direction RAI condition is transmitted by the backplane when it receives a DS-1 TX-AIS. This alarm is raised only at the transmit side, but RAI is raised at both ends.



Note

The DS1-56 card operating in retiming mode reports a Transmit Condition remote alarm indication (TX-RAI) alarm in the alarm log. However, the physical signal that is transmitted out does not have TX-RAI in the frame. Hence, TX-RAI is not transmitted in the DS1 signal. This causes the client equipment not to detect TX-RAI in the incoming signal.

Clear the TX-RAI Condition

-
- Step 1** Complete the “[Clear the TX-AIS Condition](#)” procedure on page 2-252.
- Step 2** If the condition does not clear, log into the Technical Support Website at <http://www.cisco.com/techsupport> for more information or call Cisco TAC 1 800 553-2447.
-

2.7.425 UNC-WORD

For information about this alarm or condition, refer to the “Alarm Troubleshooting” chapter in the *Cisco ONS 15454 DWDM Troubleshooting Guide*. This guide discusses all DWDM alarms.

2.7.426 UNEQ-P

Default Severity: Critical (CR), Service-Affecting (SA)

SONET Logical Objects: STSMON, STSTRM

An SLMF UNEQ Path alarm occurs when the path does not have a valid sender. The UNEQ-P indicator is carried in the C2 signal path byte in the SONET overhead. The source of the problem is the node that is transmitting the signal into the node reporting the UNEQ-P.

The alarm could result from a PARTIAL circuit or an empty VT tunnel. UNEQ-P occurs in the node that terminates a path.

**Note**

If a newly created circuit has no signal, a UNEQ-P alarm is reported on the OC-N cards and the “[AIS-P](#)” condition on page 2-38 is reported on the terminating cards. These alarms clear when the circuit carries a signal.

**Caution**

Deleting a circuit affects traffic.

Clear the UNEQ-P Alarm

-
- Step 1** In node view, choose **Go to Network View from the View menu**.
- Step 2** Right-click the alarm to display the Select Affected Circuits shortcut menu.
- Step 3** Click **Select Affected Circuits**.
- Step 4** When the affected circuits appear, look in the Type column for VTT, which indicates a VT tunnel circuit. A VT tunnel with no VTs assigned could be the cause of an UNEQ-P alarm.
- Step 5** If the Type column does not contain VTT, there are no VT tunnels connected with the alarm. Go to [Step 7](#).
- Step 6** If the Type column does contain VTT, attempt to delete these rows:



Note The node does not allow you to delete a valid VT tunnel or one with a valid VT circuit inside.

- a. Click the VT tunnel circuit row to highlight it. Complete the [“Delete a Circuit” procedure on page 2-276](#).
- b. If an error message dialog box appears, the VT tunnel is valid and not the cause of the alarm.
- c. If any other rows contain VTT, repeat [Step 6](#).

- Step 7** If all nodes in the ring appear in the CTC network view, determine whether the circuits are complete:
- a. Click the **Circuits** tab.
 - b. Verify that PARTIAL is not listed in the Status column of any circuits.
- Step 8** If you find circuits listed as PARTIAL, use an optical test set to verify that these circuits are not working circuits that continue to pass traffic. For specific procedures to use the test set equipment, consult the manufacturer.
- Step 9** If the PARTIAL circuits are not needed or are not passing traffic, delete the PARTIAL circuits. Complete the [“Delete a Circuit” procedure on page 2-276](#).
- Step 10** Recreate the circuit with the correct circuit size. Refer to the [“Create Circuits and VT Tunnels” chapter in the Cisco ONS 15454 Procedure Guide](#).
- Step 11** Log back in and verify that all circuits terminating in the reporting card are active:
- a. Click the **Circuits** tab.
 - b. Verify that the **Status** column lists all circuits as active.
- Step 12** If the alarm does not clear, clean the far-end optical fiber according to site practice. If no site practice exists, complete the procedure in the [“Maintain the Node” chapter of the Cisco ONS 15454 Procedure Guide](#).

**Warning**

On the OC-192 card, the laser is on when the card is booted and the safety key is in the on position (labeled 1). The port does not have to be in service for the laser to be on. The laser is off when the safety key is off (labeled 0). Statement 293

**Warning**

Invisible laser radiation could be emitted from the end of the unterminated fiber cable or connector. Do not stare into the beam directly with optical instruments. Viewing the laser output with certain optical instruments (for example, eye loupes, magnifiers, and microscopes) within a distance of 100 mm could pose an eye hazard. Statement 1056

**Warning**

Use of controls, adjustments, or performing procedures other than those specified could result in hazardous radiation exposure. Statement 1057

**Caution**

Always use the supplied electrostatic discharge wristband when working with a powered ONS 15454. Plug the wristband cable into the ESD jack located on the lower-right edge of the shelf assembly.

- Step 13** If the alarm does not clear, complete the [“Physically Replace a Traffic Card” procedure on page 2-274](#) for the OC-N and electrical cards.

- Step 14** If the alarm does not clear, log into the Technical Support Website at <http://www.cisco.com/techsupport> for more information or call Cisco TAC 1 800 553-2447 in order to report a Service-Affecting (SA) problem.
-

2.7.427 UNEQ-V

Default Severity: Major (MJ), Service-Affecting (SA)

SONET Logical Objects: VT-MON, VT-TERM

An SLMF UNEQ VT alarm indicates that the node is receiving SONET path overhead with Bits 5, 6, and 7 of the V5 overhead byte all set to zeroes. The source of the problem is not the node raising the alarm, but the node transmitting the VT signal to it. The V in UNEQ-V indicates that the failure has occurred at the VT layer.



Warning

On the OC-192 card, the laser is on when the card is booted and the safety key is in the on position (labeled 1). The port does not have to be in service for the laser to be on. The laser is off when the safety key is off (labeled 0). Statement 293.



Warning

Invisible laser radiation could be emitted from the end of the unterminated fiber cable or connector. Do not stare into the beam directly with optical instruments. Viewing the laser output with certain optical instruments (for example, eye loupes, magnifiers, and microscopes) within a distance of 100 mm could pose an eye hazard. Statement 1056



Warning

Use of controls, adjustments, or performing procedures other than those specified could result in hazardous radiation exposure. Statement 1057

Clear the UNEQ-V Alarm

- Step 1** Complete the [“Clear the UNEQ-P Alarm” procedure on page 2-253](#).



Caution

Always use the supplied electrostatic discharge wristband when working with a powered ONS 15454. Plug the wristband cable into the ESD jack located on the lower-right edge of the shelf assembly.

- Step 2** If the alarm does not clear, log into the Technical Support Website at <http://www.cisco.com/techsupport> for more information or call Cisco TAC 1 800 553-2447 in order to report a Service-Affecting (SA) problem.
-

2.7.428 UNQUAL-PPM

Default Severity: Minor (MN), Non-Service-Affecting (NSA)

SONET Logical Objects: PPM

The Unqualified PPM Inserted condition occurs when a PPM with a nonqualified product ID is plugged into the card's port; that is, the PPM passes the security code check as a Cisco PPM but is not qualified for use on the particular card.

Clear the UNQUAL-PPM Condition

-
- Step 1** Obtain the correct Cisco PPM and replace the existing PPM with the new one.
- Step 2** If the condition does not clear, log into the Technical Support Website at <http://www.cisco.com/techsupport> for more information or call Cisco TAC 1 800 553-2447.
-

2.7.429 UT-COMM-FAIL

For information about this alarm or condition, refer to the “Alarm Troubleshooting” chapter in the *Cisco ONS 15454 DWDM Troubleshooting Guide*. This guide discusses all DWDM alarms.

2.7.430 UT-FAIL

For information about this alarm or condition, refer to the “Alarm Troubleshooting” chapter in the *Cisco ONS 15454 DWDM Troubleshooting Guide*. This guide discusses all DWDM alarms.

2.7.431 VCG-DEG

Default Severity: Not Alarmed (NA), Non-Service-Affecting (NSA)

SONET Logical Object: VCG

The VCAT Group Degraded alarm is a VCAT group alarm. (VCATs are groups of independent circuits that are concatenated from different time slots into higher-rate signals.) The alarm occurs when one member circuit carried by the ML-Series Ethernet card is down. This alarm is accompanied by the “[OOU-TPT](#)” alarm on page 2-191. It only occurs when a Critical (CR) alarm, such as LOS, causes a signal loss.



Note

For more information about Ethernet cards, refer to the *Cisco ONS 15454 and Cisco ONS 15454 SDH Ethernet Card Software Feature and Configuration Guide*.

Clear the VCG-DEG Condition

-
- Step 1** Look for and clear any Critical (CR) alarms that apply to the errored card, such as the “[LOS \(2R\)](#)” alarm on page 2-158 or “[LOS \(OTS\)](#)” alarm on page 2-167.
- Step 2** If the condition does not clear, log into the Technical Support Website at <http://www.cisco.com/techsupport> for more information or call Cisco TAC 1 800 553-2447.
-

2.7.432 VCG-DOWN

Default Severity: Not Alarmed (NA), Non-Service-Affecting (NSA)

SONET Logical Object: VCG

The VCAT Group Down alarm is a VCAT group alarm. (VCATs are groups of independent circuits that are concatenated from different time slots into higher-rate signals.) The alarm occurs when one or more member circuits carried by an ML-Series or CE-Series Ethernet card are down. This alarm occurs in conjunction with another Critical (CR) alarm, such as the “[LOS \(2R\)](#)” alarm on page 2-158.

**Note**

If LCAS (Link Capacity Adjustment Scheme) is not enabled, the VCAT group transitions to the down state with even a single member down. If SW-LCAS is enabled on the VCAT group for ML1 cards, or HW LCAS is enabled for CE cards, the VCAT group transitions to the VCG-DOWN state only when all the members are down. The presence of at least one working member causes the VCAT group to remain in VCG-DEG (VCG degraded) state.

**Note**

For more information about Ethernet cards, refer to the *Cisco ONS 15454 and Cisco ONS 15454 SDH Ethernet Card Software Feature and Configuration Guide*.

Clear the VCG-DOWN Condition

-
- Step 1** Complete the “[Clear the VCG-DEG Condition](#)” procedure on page 2-256.
- Step 2** If the condition does not clear, log into the Technical Support Website at <http://www.cisco.com/techsupport> for more information or call Cisco TAC 1 800 553-2447.
-

2.7.433 VOA-HDEG

For information about this alarm or condition, refer to the “Alarm Troubleshooting” chapter in the *Cisco ONS 15454 DWDM Troubleshooting Guide*. This guide discusses all DWDM alarms.

2.7.434 VOA-HFAIL

For information about this alarm or condition, refer to the “Alarm Troubleshooting” chapter in the *Cisco ONS 15454 DWDM Troubleshooting Guide*. This guide discusses all DWDM alarms.

2.7.435 VOA-LDEG

For information about this alarm or condition, refer to the “Alarm Troubleshooting” chapter in the *Cisco ONS 15454 DWDM Troubleshooting Guide*. This guide discusses all DWDM alarms.

2.7.436 VOA-LFAIL

For information about this alarm or condition, refer to the “Alarm Troubleshooting” chapter in the *Cisco ONS 15454 DWDM Troubleshooting Guide*. This guide discusses all DWDM alarms.

2.7.437 VOLT-MISM

Default Severity: Not Alarmed (NA), Non-Service-Affecting (NSA)

SONET Logical Object: PWR

The Power Monitoring Mismatch Between Control Cards alarm is raised against the shelf when the power voltages of both TCC2/TCC2Ps are out of range of each other by more than 5 VDC.

Clear the VOLT-MISM Condition

-
- Step 1** Check the incoming voltage level to the shelf using a voltmeter. Follow site practices or refer to the “Install the Shelf and Backplane Cable” chapter in the *Cisco ONS 15454 Procedure Guide* for power installation procedures.
 - Step 2** Correct any incoming voltage issues.
 - Step 3** If the alarm does not clear, log into the Technical Support Website at <http://www.cisco.com/techsupport> for more information or call Cisco TAC 1 800 553-2447.
-

2.7.438 VT-SQUELCH-L

Default Severity: Not Alarmed (NA), Non-Service-Affecting (NSA)

SONET Logical Object: OCN

The Ring is Squelching VT Traffic condition is raised on an OC-N facility. If the node failure scenario includes the source node, the node dropping VT will squelch VT traffic. The condition resolves when the node failure is recovered.

This condition is raised as NA severity by default. However, it indicates that traffic is squelched due to node failure, that is, traffic outage. Traffic outage can be caused by different problems, such as multiple instances of the “[LOS \(OCN\)](#)” alarm on page 2-165, the “[AIS-L](#)” condition on page 2-38, or node power outage. VT-SQUELCH-L is symptomatic and indicates that the user must investigate which node in a ring is being isolated and what causes node isolation.



Note

VT-SQUELCH-L is an informational condition.

2.7.439 WKSWPR

Default Severity: Not Alarmed (NA), Non-Service-Affecting (NSA)

SONET Logical Objects: EQPT, OCN, STSMON, VT-MON

DWDM Logical Objects: 2R, ESCON, FC, GE, ISC

The Working Switched To Protection condition occurs when a line experiences the “LOS (OCN)” alarm on page 2-165, the “SD (DS1, DS3)” condition on page 2-218, or the “SD (TRUNK)” condition on page 2-221.

This condition is also raised when you use the Manual Switch, APS Switch, FORCE SPAN, FORCE RING or MANUAL SPAN command at the network level. WKSWPR is visible on the network view Alarms, Conditions, and History tabs.

Clear the WKSWPR Condition

-
- Step 1** Complete the “Clear the LOS (OCN) Alarm” procedure on page 2-166.
- Step 2** If the condition does not clear, log into the Technical Support Website at <http://www.cisco.com/techsupport> for more information or call Cisco TAC 1 800 553-2447.
-

2.7.440 WTR

Default Severity: Not Alarmed (NA), Non-Service-Affecting (NSA)

SONET Logical Objects: EC1, EQPT, ML1000, ML100T, MLFX, OCN, STSMON, VT-MON

DWDM Logical Objects: 2R, ESCON, FC, GE, ISC, TRUNK

The Wait To Restore condition for SONET and DWDM objects occurs when the “WKSWPR” condition on page 2-258 is raised, but the wait-to-restore time has not expired, meaning that the active protect path cannot revert to the working path. The condition clears when the timer expires and traffic switches back to the working path.

If the condition is raised on an IEEE 802.17b-based RPR span, it indicates that the wait-to-restore timer is active after a span failure has cleared.



Caution

DS-1 traffic loss can occur on a DS-1 with 1:N protection if a DS-1 card is reset with the protect card in the WTR state.



Note

Generally, WTR is an informational condition and does not require troubleshooting.

Clear the WTR Condition on an IEEE 802.17b-Based RPR Span

-
- Step 1** Determine the setting for the IEEE 802.17b-based RPR interface’s WTR timer setting. In privileged executive mode, enter the following command:
- ```
router#show interface rpr protection
```
- View the WTR timer setting.
- Step 2** If the timer is set to “never,” clear the WTR condition by requesting a forced switch on the span. Enter the following command at the RPR-IEEE interface configuration mode command prompt:
- ```
router(config-if)#rpr-ieee protection request force-switch {east | west}
```

Step 3 If you configured a FORCE on the span, clear the switch with the following command:

```
router(config-if)#no rpr-ieee protection request force-switch {east | west}
```

Step 4 If the condition does not clear, log into the Technical Support Website at <http://www.cisco.com/techsupport> for more information or call Cisco TAC 1 800 553-2447.

2.7.441 WVL-MISMATCH

For information about this alarm or condition, refer to the “Alarm Troubleshooting” chapter in the *Cisco ONS 15454 DWDM Troubleshooting Guide*. This guide discusses all DWDM alarms.

2.8 Traffic Card LED Activity

ONS 15454 traffic card LED behavior patterns are listed in the following sections. These sections give behavior for card insertion, reset, and side-switch.

2.8.1 Typical Traffic Card LED Activity After Insertion

When a card is inserted, the following LED activities occur:

1. The red FAIL LED turns on and remains illuminated for 20 to 30 seconds.
2. The red FAIL LED blinks for 35 to 45 seconds.
3. All LEDs blink once and turn off for 5 to 10 seconds.
4. The ACT or ACT/SBY LED turns on. The SF LED can persist until all card ports connect to their far-end counterparts and a signal is present.

2.8.2 Typical Traffic Card LED Activity During Reset

While a card resets, the following LED activities occur:

1. The FAIL LED on the physical card blinks and turns off.
2. The white LED with the letters “LDG” appears on the reset card in CTC.
3. The green ACT LED appears in CTC.

2.8.3 Typical Card LED State After Successful Reset

When a card successfully resets, the following LED states are present:

- If you are looking at the physical ONS 15454, the ACT/SBY LED is illuminated.
- If you are looking at node view of the ONS 15454, the current standby card has an amber LED depiction with the initials “SBY,” and this has replaced the white “LDG” depiction on the card in CTC.

- If you are looking at node view of the ONS 15454, the current active card has a green LED depiction with the initials “ACT,” and this has replaced the white “LDG” depiction on the card in CTC.

2.8.4 Typical Cross-Connect LED Activity During Side Switch

When a XC10G card is switched in CTC from active (ACT) to standby (SBY) or from SBY to ACT, the following LED activities occur:

1. The FAIL LED on the physical card blinks and turns off.
2. The standby card yellow SBY LED becomes a green ACT LED, indicating it is now active.
3. The active card green ACT LED becomes a yellow SBY LED, indicating it is now standby.

2.9 Frequently Used Alarm Troubleshooting Procedures

This section gives common procedures that are frequently used when troubleshooting alarms. Most of these procedures are summarized versions of fuller procedures existing elsewhere in the ONS 15454 documentation. They are included in this chapter for the user’s convenience. For further information, please refer to the *Cisco ONS 15454 Procedure Guide*.

2.9.1 Node and Ring Identification, Change, Visibility, and Termination

The following procedures relate how to identify or change BLSR names and node IDs, and how to verify visibility from other nodes.

Identify a BLSR Ring Name or Node ID Number

-
- Step 1** Log into a node on the network.
- Step 2** In node view, choose **Go to Network View from the View menu**.
- Step 3** Click the **Provisioning > BLSR** tabs.
- Step 4** From the Ring Name column, record the ring name, or in the Nodes column, record the Node IDs in the BLSR. The Node IDs are the numbers in parentheses next to the node name.
-

Change a BLSR Ring Name

-
- Step 1** Log into a node on the network.
- Step 2** In node view, choose **Go to Network View from the View menu**.
- Step 3** Click the **Provisioning > BLSR** tabs.
- Step 4** Highlight the ring and click **Edit**.
- Step 5** In the BLSR window, enter the new name in the Ring Name field.
- Step 6** Click **Apply**.

Step 7 Click **Yes** in the Changing Ring Name dialog box.

Change a BLSR Node ID Number

- Step 1** Log into a node on the network.
- Step 2** In node view, choose **Go to Network View from the View menu**.
- Step 3** Click the **Provisioning > BLSR** tabs.
- Step 4** Highlight the ring and click **Edit**.
- Step 5** In the BLSR window, right-click the node on the ring map.
- Step 6** Select **Set Node ID** from the shortcut menu.
- Step 7** In the Edit Node ID dialog box, enter the new ID. The Node ID is the number in parentheses after the Node Name.
- Step 8** Click **OK**.
-

Verify Node Visibility for Other Nodes

- Step 1** Log into a node on the network.
- Step 2** In node view, click the **Provisioning > BLSR** tabs.
- Step 3** Highlight a BLSR.
- Step 4** Click **Ring Map**.
- Step 5** In the BLSR Ring Map window, verify that each node in the ring appears on the ring map with a node ID and IP address.
- Step 6** Click **Close**.
-

2.9.2 Protection Switching, Lock Initiation, and Clearing

The following sections give instructions for port, ring, and span switching and switch-clearing commands, as well as lock-ons and lockouts.

Initiate a 1+1 Force Switch Command

This procedure switches 1+1 protection group traffic from one port in the group to the other using a Force switch.



Caution

The Force command overrides normal protective switching mechanisms. Applying this command incorrectly can cause traffic outages.

**Caution**

Traffic is not protected during a Force protection switch.

**Note**

A Force command switches traffic on a working path even if the path has signal degrade (SD) or signal fail (SF) conditions. A Force switch does not switch traffic on a protect path. A Force switch preempts a Manual switch.

-
- Step 1** In node view, click the **Maintenance > Protection** tabs.
- Step 2** In the Protection Groups area, select the protection group with the port you want to switch.
- Step 3** In the Selected Groups area, select the port belonging to the card you are replacing. You can carry out this command for the working or protect port. For example, if you need to replace the card with the Protect/Standby port, click this port.
- Step 4** In the Switch Commands area, click **Force**.
- Step 5** Click **Yes** in the Confirm Force Operation dialog box.
- Step 6** If the switch is successful, the group says “Force to working” in the Selected Groups area.
-

Initiate a 1+1 Manual Switch Command

This procedure switches 1+1 protection group traffic from one port in the group to the other using a Manual switch.

**Note**

A Manual command switches traffic if the path has an error rate less than the signal degrade. A Manual switch is preempted by a Force switch.

-
- Step 1** In node view, click the **Maintenance > Protection** tabs.
- Step 2** In the Protection Groups area, select the protection group with the port you want to switch.
- Step 3** In the Selected Groups area, select the port belonging to the card you are replacing. You can carry out this command for the working or protect port. For example, if you need to replace the card with the protect/standby port, click this port.
- Step 4** In the Switch Commands area, click **Manual**.
- Step 5** Click **Yes** in the Confirm Force Operation dialog box.
- Step 6** If the switch is successful, the group now says “Manual to working” in the Selected Groups area.
-

Clear a 1+1 Force or Manual Switch Command

Note

If the 1+1 protection group is configured as revertive, clearing a Force switch to protect (or working) moves traffic back to the working port. In revertive operation, the traffic always switches back to working. There is no revert to the protect. If ports are not configured as revertive, clearing a Force switch to protect does not move traffic back.

Note

If the Force Switch was user-initiated, the reversion occurs immediately when the clear command is issued. The five-minute WTR period is not needed in this case. If the Force was system-initiated, allow the five-minute waiting period (during WTR) before the reversion occurs.

-
- Step 1** In node view, click the **Maintenance > Protection** tabs.
- Step 2** In the Protection Groups area, choose the protection group containing the port you want to clear.
- Step 3** In the Selected Group area, choose the port you want to clear.
- Step 4** In the Switching Commands area, click **Clear**.
- Step 5** Click **Yes** in the Confirmation Dialog box.
- The Force switch is cleared. Traffic immediately reverts to the working port if the group was configured for revertive switching.
-

Initiate a Lock-On Command

Note

For 1:1 and 1:N electrical protection groups, working or protect cards can be placed in the Lock On state. For a 1+1 optical protection group, only the working port can be placed in the Lock On state.

-
- Step 1** In node view, click the **Maintenance > Protection** tabs.
- Step 2** In the Protection Groups list, click the protection group where you want to apply a lock-on.
- Step 3** If you determine that the protect card is in standby mode and you want to apply the lock-on to the protect card, make the protect card active if necessary:
- a. In the Selected Group list, click the protect card.
 - b. In the Switch Commands area, click **Force**.
- Step 4** In the Selected Group list, click the active card where you want to lock traffic.
- Step 5** In the Inhibit Switching area, click **Lock On**.
- Step 6** Click **Yes** in the confirmation dialog box.
-

Initiate a Card or Port Lockout Command

**Note**

For 1:1 or 1:N electrical protection groups, working or protect cards can be placed in the Lock Out state. For a 1+1 optical protection group, only the protect port can be placed in the Lock Out state.

-
- Step 1** In node view, click the **Maintenance > Protection** tabs.
- Step 2** In the Protection Groups list, click the protection group that contains the card you want to lockout.
- Step 3** In the Selected Group list, click the card where you want to lock out traffic.
- Step 4** In the Inhibit Switching area, click **Lock Out**.
- Step 5** Click **Yes** in the confirmation dialog box.
- The lockout has been applied and traffic is switched to the opposite card.
-

Clear a Lock-On or Lockout Command

-
- Step 1** In node view, click the **Maintenance > Protection** tabs.
- Step 2** In the Protection Groups list, click the protection group that contains the card you want to clear.
- Step 3** In the Selected Group list, click the card you want to clear.
- Step 4** In the Inhibit Switching area, click **Unlock**.
- Step 5** Click **Yes** in the confirmation dialog box.
- The lock-on or lockout is cleared.
-

Initiate a 1:1 Card Switch Command

**Note**

The Switch command only works on the Active card, whether it is working or protect. It does not work on the Standby card.

-
- Step 1** In node view, click the **Maintenance > Protection** tabs.
- Step 2** Click the protection group that contains the card you want to switch.
- Step 3** Under Selected Group, click the active card.
- Step 4** Next to Switch Commands, click **Switch**.
- The working slot should change to Working/Active and the protect slot should change to Protect/Standby.
-

Initiate a Force Switch for All Circuits on a Path Protection Span

This procedure forces all circuits in a path protection from the working span to the protect. It is used to remove traffic from a card that originates or terminates path protection circuits.



Caution

The Force command overrides normal protective switching mechanisms. Applying this command incorrectly can cause traffic outages.



Caution

Traffic is not protected during a Force protection switch.

-
- Step 1** Log into a node on the network.
- Step 2** In node view, choose **Go to Network View from the View menu**.
- Step 3** Right-click a network span and choose **Circuits**.
The Circuits on Span dialog box shows the path protection circuits, including circuit names, locations, and a color code showing which circuits are active on the span.
- Step 4** Click the **Perform UPSR span switching** field.
- Step 5** Choose **Force Switch Away** from the drop-down list.
- Step 6** Click **Apply**.
- Step 7** In the Confirm UPSR Switch dialog box, click **Yes**.
- Step 8** In the Protection Switch Result dialog box, click **OK**.
In the Circuits on Span dialog box, the switch state for all circuits is FORCE. Unprotected circuits do not switch.
-

Initiate a Manual Switch for All Circuits on a Path Protection Span

This procedure manually switches all circuits in a path protection from the working span to the protect. It is used to remove traffic from a card that originates or terminates path protection circuits.



Caution

The Manual command does not override normal protective switching mechanisms.

-
- Step 1** Log into a node on the network.
- Step 2** Right-click a network span and choose **Circuits**.
The Circuits on Span dialog box shows the path protection circuits, including circuit names, locations, and a color code showing which circuits are active on the span.
- Step 3** Click the **Perform UPSR span switching** field.
- Step 4** Choose **Manual** from the drop-down list.
- Step 5** Click **Apply**.
- Step 6** In the Confirm UPSR Switch dialog box, click **Yes**.
- Step 7** In the Protection Switch Result dialog box, click **OK**.

In the Circuits on Span dialog box, the switch state for all circuits is Manual. Unprotected circuits do not switch.

Initiate a Lockout for All Circuits on a Protect Path Protection Span

This procedure prevents all circuits in a path protection working span from switching to the protect span. It is used to keep traffic off cards that originate or terminate path protection circuits.



Caution

The Lock Out of Protect command overrides normal protective switching mechanisms.

- Step 1** Log into a node on the network. If you are already logged in, continue with [Step 2](#).
- Step 2** Right-click a network span and choose **Circuits**.
- The Circuits on Span dialog box shows the path protection circuits, including circuit names, locations, and a color code showing which circuits are active on the span.
- Step 3** Click the **Perform UPSR span switching** field.
- Step 4** Choose **Lock Out of Protect** from the drop-down list.
- Step 5** Click **Apply**.
- Step 6** In the Confirm UPSR Switch dialog box, click **Yes**.
- Step 7** In the Protection Switch Result dialog box, click **OK**.
- In the Circuits on Span dialog box, the switch state for all circuits is LOCKOUT. Unprotected circuits do not switch.
-

Clear an External Switching Command on a Path Protection Span



Note

If the ports terminating a span are configured as revertive, clearing a Force or Manual switch to protect moves traffic back to the working port. If ports are not configured as nonrevertive, clearing a Force switch to protect does not move traffic back.

- Step 1** Log into a node on the network. If you are already logged in, continue with [Step 2](#).
- Step 2** Right-click a network span and choose **Circuits**.
- The Circuits on Span dialog box shows the path protection circuits, including circuit names, locations, and a color code showing which circuits are active on the span.
- Step 3** Initiate a Force switch for all circuits on the span:
- Click the **Perform UPSR span switching** field.
 - Choose **Clear** from the drop-down list.
 - Click **Apply**.
 - In the Confirm UPSR Switch dialog box, click **Yes**.
 - In the Protection Switch Result dialog box, click **OK**.

In the Circuits on Span dialog box, the switch state for all circuits is Clear. Unprotected circuits do not switch.

Initiate a Force Ring Switch on a BLSR

- Step 1** Log into a node on the network. If you are already logged in, continue with [Step 2](#).
 - Step 2** From the View menu choose **Go to Network View**.
 - Step 3** In network view, click the **Provisioning > BLSR** tabs.
 - Step 4** Click the row of the BLSR you are switching, then click **Edit**.
 - Step 5** Right-click a BLSR node west port and choose **Set West Protection Operation**.
 - Step 6** In the Set West Protection Operation dialog box, choose **Force Ring** from the drop-down list.
 - Step 7** Click **OK**.
 - Step 8** Click **Yes** in the two Confirm BLSR Operation dialog boxes that appear.
-

Initiate a Force Span Switch on a Four-Fiber BLSR

- Step 1** Log into a node on the network.
 - Step 2** From the View menu choose **Go to Network View**.
 - Step 3** In network view, click the **Provisioning > BLSR** tabs.
 - Step 4** Click the row of the BLSR you are switching, then click **Edit**.
 - Step 5** Right-click a BLSR node west port and choose **Set West Protection Operation**.
 - Step 6** In the Set West Protection Operation dialog box, choose **Force Span** from the drop-down list.
 - Step 7** Click **OK**.
 - Step 8** Click **Yes** in the two Confirm BLSR Operation dialog boxes that appear.
-

Initiate a Manual Span Switch on a BLSR

- Step 1** From the View menu, choose **Go to Network View**.
- Step 2** Click the **Provisioning > BLSR** tabs.
- Step 3** Choose the BLSR and click **Edit**.
- Step 4** Right-click the BLSR node channel (port) and choose **Set West Protection Operation** (if you chose a west channel) or **Set East Protection Operation** (if you chose an east channel).
- Step 5** In the Set West Protection Operation dialog box or the Set East Protection Operation dialog box, choose **Manual Span** from the drop-down list.
- Step 6** Click **OK**.

- Step 7** Click **Yes** in the two Confirm BLSR Operation dialog boxes.
-

Initiate a Manual Ring Switch on a BLSR

- Step 1** From the View menu, choose **Go to Network View**.
- Step 2** Click the **Provisioning > BLSR** tabs.
- Step 3** Choose the BLSR and click **Edit**.
- Step 4** Right-click the BLSR node channel (port) and choose **Set West Protection Operation** (if you chose a west channel) or **Set East Protection Operation** (if you chose an east channel).
- Step 5** In the Set West Protection Operation dialog box or the Set East Protection Operation dialog box, choose **Manual Ring** from the drop-down list.
- Step 6** Click **OK**.
- Step 7** Click **Yes** in the two Confirm BLSR Operation dialog boxes.
-

Initiate a Lockout on a BLSR Protect Span

- Step 1** From the View menu choose **Go to Network View**.
- Step 2** Click the **Provisioning > BLSR** tabs.
- Step 3** Choose the BLSR and click **Edit**.
- Step 4** Right-click the BLSR node channel (port) and choose **Set West Protection Operation** (if you chose a west channel) or **Set East Protection Operation** (if you chose an east channel).
- Step 5** In the Set West Protection Operation dialog box or the Set East Protection Operation dialog box, choose **Lockout Protect Span** from the drop-down list.
- Step 6** Click **OK**.
- Step 7** Click **Yes** in the two Confirm BLSR Operation dialog boxes.
-

Initiate an Exercise Ring Switch on a BLSR

- Step 1** Log into a node on the network.
- Step 2** Click **View > Go to Network View**.
- Step 3** Click the **Provisioning > BLSR** tabs.
- Step 4** Click the row of the BLSR you are exercising, then click **Edit**.
- Step 5** Right-click the west port of a node and choose **Set West Protection Operation**.
- Step 6** In the Set West Protection Operation dialog box, choose **Exercise Ring** from the drop-down list.
- Step 7** Click **OK**.

Step 8 Click **Yes** in the Confirm BLSR Operation dialog box.

Initiate an Exercise Ring Switch on a Four Fiber BLSR

- Step 1** Log into a node on the network.
 - Step 2** From the View menu, choose **Go to Network View**.
 - Step 3** Click the **Provisioning > BLSR** tabs.
 - Step 4** Click the row of the BLSR you are exercising, then click **Edit**.
 - Step 5** Right-click the west port of a node and choose **Set West Protection Operation**.
 - Step 6** In the Set West Protection Operation dialog box, choose **Exercise Span** from the drop-down list.
 - Step 7** Click **OK**.
 - Step 8** Click **Yes** in the Confirm BLSR Operation dialog box.
-

Clear a BLSR External Switching Command

- Step 1** Log into a node on the network.
 - Step 2** From the View menu, choose **Go to Network View**.
 - Step 3** Click the **Provisioning > BLSR** tabs.
 - Step 4** Click the BLSR you want to clear.
 - Step 5** Right-click the west port of the BLSR node where you invoked the switch and choose **Set West Protection Operation**.
 - Step 6** In the Set West Protection Operation dialog box, choose **Clear** from the drop-down list.
 - Step 7** Click **OK**.
 - Step 8** Click **Yes** in the Confirm BLSR Operation dialog box.
-

2.9.3 CTC Card Resetting and Switching

This section gives instructions for resetting traffic cards, TCC2/TCC2Ps, and cross-connect cards.



Caution

For TXP and MXP cards placed in a Y-cable protection group, do not perform a software reset on both cards simultaneously. Doing so will cause a traffic hit of more than one minute. For more information about Y-cable protection groups, refer to the *Cisco ONS 15454 DWDM Procedure Guide*.



Caution

Resetting the active card in a Y-cable group will cause a traffic outage if the standby card is down for any reason.

**Note**

When an AIC-I card is reset in CTC, any subsequent user client operations (such as CTC or TL1 activity) is paused for approximately 5-10 seconds. The reset does not cause any conditions to be raised.

**Note**

For more information about MXP and TXP cards, refer to the *Cisco ONS 15454 DWDM Reference Manual*.

Reset a Traffic Card in CTC

-
- Step 1** Log into a node on the network. If you are already logged in, continue with [Step 2](#).
- Step 2** In node view, position the cursor over the optical or electrical traffic card slot reporting the alarm.
- Step 3** Right-click the card. Choose **Reset Card** from the shortcut menu.
- Step 4** Click **Yes** in the Resetting Card dialog box.
-

Reset an Active TCC2/TCC2P Card and Activate the Standby Card

**Caution**

Resetting an active TCC2/TCC2P can be service-affecting.

**Note**

Before you reset the TCC2/TCC2P, you should wait at least 60 seconds after the last provisioning change you made to avoid losing any changes to the database.

-
- Step 1** Log into a node on the network. If you are already logged in, continue with [Step 2](#).
- Step 2** Identify the active TCC2/TCC2P:
If you are looking at the physical ONS 15454 shelf, the ACT/SBY LED of the active card is green. The ACT/STBLY LED of the standby card is amber.
- Step 3** Right-click the active TCC2/TCC2P in CTC.
- Step 4** Choose **Reset Card** from the shortcut menu.
- Step 5** Click **Yes** in the Confirmation Dialog box.
The card resets, the FAIL LED blinks on the physical card, and connection to the node is lost. CTC switches to network view.
- Step 6** Verify that the reset is complete and error-free and that no new related alarms appear in CTC. For LED appearance, see the “[2.8.3 Typical Card LED State After Successful Reset](#)” section on page 2-260.
- Step 7** Double-click the node and ensure that the reset TCC2/TCC2P is in standby mode and that the other TCC2/TCC2P is active. Verify the following:
- If you are looking at the physical ONS 15454 shelf, the ACT/SBY LED of the active card is green. The ACT/STBLY LED of the standby card is amber.

- No new alarms appear in the Alarms window in CTC.

Side Switch the Active and Standby Cross-Connect Cards



Caution The cross-connect card side switch is usually service-affecting.

- Step 1** Log into a node on the network. For instructions regarding how to log into a node, refer *Cisco ONS 15454 Procedure Guide, Release 8.0*. If you are already logged in, continue with [Step 2](#).
- Step 2** Display node view.
- Step 3** Determine the active or standby XC10G card.
The ACT/SBY LED of the active card is green. The ACT/SBY LED of the standby card is amber.



Note You can also position the cursor over the card graphic to display a popup identifying the card as active or standby.

- Step 4** In node view, click the **Maintenance > Cross-Connect > Cards** tabs.
- Step 5** Click **Switch**.
- Step 6** Click **Yes** in the Confirm Switch dialog box. See the “[2.8.4 Typical Cross-Connect LED Activity During Side Switch](#)” section on page 2-261 for LED information.



Note During a maintenance side switch or soft reset of an active XC10G card, the 1+1 protection group might display a protection switch. To disallow the protection switch from being displayed, the protection group should be locked at the node where XC switch or soft reset of an active XC switch is in progress.



Caution Active cross connect (XC10G/XCVT) cards should not be physically removed.

The following rules must be followed for removing an Active Cross Connect Card (XC10G/XCVT):

If the active cross connect has to be removed, perform an XCVT/XC10G side switch to change the status of the card from active to standby and then remove the cross connect card once it goes back to standby.

OR

Perform a lockout on all circuits that originate from the node whose active cross connect card has to be removed (performing a lockout on all spans will also accomplish the same goal).

2.9.4 Physical Card Reseating, Resetting, and Replacement

This section gives instructions for physically reseating and replacing TCC2/TCC2P, cross-connect, and traffic cards.

**Caution**

Do not physically replace a card without first making provisions to switch or move traffic to a different card or circuit. General procedures for this are located in the “[2.9.2 Protection Switching, Lock Initiation, and Clearing](#)” section on page 2-262. In-depth traffic switching procedures and information can be found in the “Maintain the Node” chapter of the *Cisco ONS 15454 Procedure Guide*.

Remove and Reinsert (Reseat) the Standby TCC2/TCC2P Card

**Caution**

Always use the supplied electrostatic discharge wristband when working with a powered ONS 15454. Plug the wristband cable into the ESD jack located on the lower-right edge of the shelf assembly.

**Caution**

Do not perform this action without the supervision and direction of Cisco TAC 1 800 553-2447.

**Caution**

The TCC2/TCC2P reseat could be service-affecting. Refer to the “[2.9.2 Protection Switching, Lock Initiation, and Clearing](#)” section on page 2-262 for traffic-switching procedures.

**Note**

Before you reset the TCC2/TCC2P, you should wait at least 60 seconds after the last provisioning change you made to avoid losing any changes to the database.

**Note**

When a standby TCC2/TCC2P card is removed and reinserted (reseated), all three fan lights could momentarily turn on, indicating that the fans have also reset.

- Step 1** Log into a node on the network.
Ensure that the TCC2/TCC2P you want to reseat is in standby mode. A standby card has an amber ACT/SBY (Active/Standby) LED illuminated.
- Step 2** When the TCC2/TCC2P is in standby mode, unlatch both the top and bottom ejectors on the TCC2/TCC2P.
- Step 3** Physically pull the card at least partly out of the slot until the lighted LEDs turn off.
- Step 4** Wait 30 seconds. Reinsert the card and close the ejectors.

**Note**

The TCC2/TCC2P requires several minutes to reboot and display the amber standby LED after rebooting. Refer to the *Cisco ONS 15454 Reference Manual* for more information about LED behavior during a card reboot.

Remove and Reinsert (Reseat) Any Card

Caution

Always use the supplied electrostatic discharge wristband when working with a powered ONS 15454. Plug the wristband cable into the ESD jack located on the lower-right edge of the shelf assembly.

-
- Step 1** Open the card ejectors.
- Step 2** Slide the card halfway out of the slot along the guide rails.
- Step 3** Slide the card all the way back into the slot along the guide rails.
- Step 4** Close the ejectors.
-

Physically Replace a Traffic Card

Caution

Always use the supplied electrostatic discharge wristband when working with a powered ONS 15454. Plug the wristband cable into the ESD jack located on the lower-right edge of the shelf assembly.

Caution

Removing a card that currently carries traffic on one or more ports can cause a traffic hit. To avoid this, perform an external switch if a switch has not already occurred. Refer to the procedures in the [“2.9.2 Protection Switching, Lock Initiation, and Clearing” section on page 2-262](#). For more information, refer to the “Maintain the Node” chapter in the *Cisco ONS 15454 Procedure Guide*.

When you replace a card with the identical type of card, you do not need to make any changes to the database.

-
- Step 1** Open the card ejectors.
- Step 2** Slide the card out of the slot.
- Step 3** Open the ejectors on the replacement card.
- Step 4** Slide the replacement card into the slot along the guide rails.
- Step 5** Close the ejectors.
-

Physically Replace an In-Service Cross-Connect Card

Caution

The cross-connect reseat could be service-affecting. Refer to the [“2.9.2 Protection Switching, Lock Initiation, and Clearing” section on page 2-262](#) for traffic-switching procedures prior to completing this procedure.

**Note**

This procedure is placed in the chapter as a quick guide for the user's convenience. A more detailed procedure is located in the "Maintain the Node" chapter of the *Cisco ONS 15454 Procedure Guide*.

When you replace a card with the identical type of card, you do not need to make any changes to the database.

Step 1

Determine the active cross-connect card (XCVT/XC10G/XC-VXC-10G). The ACT/SBY LED of the active card is green. The ACT/SBY LED of the standby card is amber.

**Note**

You can also place the cursor over the card graphic to display a popup identifying the card as active or standby.

Step 2

Switch the active cross-connect card to standby:

- a. In the node view, click the **Maintenance > Cross-Connect** tabs.
- b. Under Cross Connect Cards, choose **Switch**.
- c. Click **Yes** in the Confirm Switch dialog box.

**Note**

After the active cross-connect card becomes standby, the original standby slot becomes active. This causes the ACT/SBY LED to become green on the former standby card.

Step 3

Physically remove the new standby cross-connect card from the ONS 15454.

**Note**

An improper removal (IMPROPRMVL) alarm is raised when a card reset is performed, unless the card is first deleted in Cisco Transport Controller (CTC). The alarm clears after the card is replaced.

Step 4

Insert the replacement cross-connect card into the empty slot.

The replacement card boots up and becomes ready for service after approximately one minute.

2.9.5 Generic Signal and Circuit Procedures

This section gives instructions for verify BER thresholds, deleting circuits, provisioning SDCC terminations, and clearing loopbacks.

Verify the Signal BER Threshold Level

Step 1

Log into a node on the network.

Step 2

In node view, double-click the card reporting the alarm to open the card view.

Step 3

Click the **Provisioning > Line** tabs.

- Step 4** Under the **SD BER** (or **SF BER**) column in the Provisioning window, verify that the cell entry is consistent with the originally provisioned threshold. The default setting is 1E-7.
- Step 5** If the entry is consistent with the original provisioning, go back to your original procedure.
- Step 6** If the entry is not consistent with what the system was originally provisioned for, click the cell to reveal the range of choices and click the original entry.
- Step 7** Click **Apply**.
-

Delete a Circuit

- Step 1** Log into a node on the network.
- Step 2** In node view, click the **Circuits** tab.
- Step 3** Click the circuit row to highlight it and click **Delete**.
- Step 4** Click **Yes** in the Delete Circuits dialog box.
-

Verify or Create Node Section DCC Terminations



Note Portions of this procedure are different for ONS 15454 DWDM nodes.

- Step 1** Log into a node on the network.
- Step 2** In node view, click the **Provisioning > Comm Channels > SDCC** tab.
- Step 3** View the Port column entries to see where terminations are present for a node. If terminations are missing, proceed to [Step 4](#).
- Step 4** If necessary, create a DCC termination:
- Click **Create**.
 - In the Create SDCC Terminations dialog box, click the ports where you want to create the DCC termination. To select more than one port, press the Shift key.
 - In the port state area, click the **Set to IS** radio button.
 - Verify that the Disable OSPF on Link check box is unchecked.
 - Click **OK**.
-

Clear an OC-N Card Facility or Terminal Loopback Circuit

- Step 1** Log into a node on the network.
- Step 2** Double-click the reporting card in CTC to open the card view.
- Step 3** Click the **Maintenance > Loopback > Port** tabs.

- Step 4** In the Loopback Type column, determine whether any port row shows a state other than None.
- Step 5** If a row contains another state besides None, click in the column cell to display the drop-down list and select None.
- Step 6** In the Admin State column, determine whether any port row shows a state other than IS.
- Step 7** If a row shows a state other than IS, click in the column cell to display the drop-down list and select **IS**.
- Step 8** Click **Apply**.



Note If a port in the IS admin state does not receive a signal, the LOS alarm is raised and the port service state transitions to OOS-AU,FLT.

Clear an OC-N Card Cross-Connect (XC) Loopback Circuit

- Step 1** Log into a node on the network.
- Step 2** Double-click the reporting card in CTC to open the card view.
- Step 3** Click the **Maintenance > Loopback > SONET STS** tabs.
- Step 4** Uncheck the XC Loopback check box.
- Step 5** Click **Apply**.
-

Clear a DS3XM-6, DS3XM-12, or DS3E-12 Card Loopback Circuit

- Step 1** Log into a node on the network.
- Step 2** Double-click the reporting card in CTC to open the card view.
- Step 3** Click the **Maintenance > DS3** tabs or the **Maintenance > DS1** tabs.
- Step 4** In the Loopback Type column, determine whether any port row shows a state other than None.
- Step 5** If a row contains another state besides None, click in the column cell to display the drop-down list and select None.
- Step 6** In the Admin State column, determine whether any port row shows a state other than IS.
- Step 7** If a row shows a state other than IS, click in the column cell to display the drop-down list and select **IS**.
- Step 8** Click **Apply**.



Note If a port in the IS admin state does not receive a signal, the LOS alarm is raised and the port service state transitions to OOS-AU,FLT.

Clear Other Electrical Card or Ethernet Card Loopbacks



Note This procedure does not apply to DS3XM-6 or DS3XM-12 cards.



Note For more information about Ethernet cards, refer to the *Cisco ONS 15454 and Cisco ONS 15454 SDH Ethernet Card Software Feature and Configuration Guide*.

- Step 1** Log into a node on the network.
- Step 2** Double-click the reporting card in CTC to open the card view.
- Step 3** Click the **Maintenance > Loopback** tabs.
- Step 4** In the Loopback Type column, determine whether any port row shows a state other than None.
- Step 5** If a row contains another state besides None, click in the column cell to display the drop-down list and select **None**.
- Step 6** In the Admin State column, determine whether any port row shows a state other than IS.
- Step 7** If a row shows a state other than IS, click in the column cell to display the drop-down list and select **IS**.
- Step 8** Click **Apply**.



Note If a port in the IS admin state does not receive a signal, the LOS alarm is raised and the port service state transitions to OOS-AU,FLT.

Clear an MXP, TXP, or FC_MR-4 Card Loopback Circuit

- Step 1** Log into a node on the network.
- Step 2** Double-click the reporting card in CTC to open the card view.
- Step 3** Click the **Maintenance > Loopback** tabs.
- Step 4** In the Loopback Type column, determine whether any port row shows a state other than None.
- Step 5** If a row contains another state besides None, click in the column cell to display the drop-down list and select None.
- Step 6** In the Admin State column, determine whether any port row shows an admin state other than IS, for example, OOS,MT.
- Step 7** If a row shows an admin state other than IS, click in the column cell to display the drop-down list and select **IS**.



Note If a port in the IS admin state does not receive a signal, the LOS alarm is raised and the port service state transitions to OOS-AU,FLT.

Step 8 Click **Apply**.

2.9.6 Air Filter and Fan Procedures

This section gives instructions for cleaning or replacing the air filter and reseating or replacing the fan tray assembly.

Inspect, Clean, and Replace the Reusable Air Filter

To complete this task, you need a vacuum cleaner or detergent and water faucet, a spare filter, and a pinned hex key.



Do not reach into a vacant slot or chassis while you install or remove a module or a fan. Exposed circuitry could constitute an energy hazard. Statement 206

Although the filter works if it is installed with either side facing up, Cisco recommends that you install it with the metal bracing facing up to preserve the surface of the filter.



Always use the supplied electrostatic discharge wristband when working with a powered ONS 15454. Plug the wristband cable into the ESD jack located on the lower-right edge of the shelf assembly.

- Step 1** Verify that you are replacing a reusable air filter. The reusable filter is made of a gray, open-cell, polyurethane foam that is specially coated to provide fire and fungi resistance. NEBS 3E and later versions of the ONS 15454 use a reusable air filter.
- Step 2** If the air filter is installed in the external filter brackets, slide the filter out of the brackets while being careful not to dislodge any dust that could have collected on the filter. If the filter is installed beneath the fan tray and not in the external filter brackets, open and remove the front door assembly by completing the following steps:
- a. Open the front door of the shelf assembly by completing the following substeps. (If it is already open or if the shelf assembly does not have a front door, continue with [Step 3](#).)
 - Open the front door lock.
 - Press the door button to release the latch.
 - Swing the door open.
 - b. Remove the front door by completing the following substeps (optional):
 - Detach the ground strap from either the door or the chassis by removing one of the Kepnuts.
 - Place the Kepnut back on the stud after the ground strap is removed to avoid misplacement.
 - Secure the dangling end of the ground strap to the door or chassis with tape.
- Step 3** Push the outer side of the handles on the fan-tray assembly to expose the handles.
- Step 4** Pull the handles and slide the fan-tray assembly one inch (25.4 mm) out of the shelf assembly and wait until the fans stop.
- Step 5** When the fans have stopped, pull the fan-tray assembly completely out of the shelf assembly.

- Step 6** Gently remove the air filter from the shelf assembly. Be careful not to dislodge any dust that could have collected on the filter.
- Step 7** Visually inspect the air filter material for dirt and dust.
- Step 8** If the reusable air filter has a concentration of dirt and dust, either vacuum or wash the air filter. Prior to washing the air filter, replace the dirty air filter with a clean air filter and also reinsert the fan-tray assembly. Wash the dirty air filter under a faucet with a light detergent.
- Spare ONS 15454 filters should be kept in stock for this purpose.



Note Cleaning should take place outside the operating environment to avoid releasing dirt and dust near the equipment.

- Step 9** If you washed the filter, allow it to completely air dry for at least eight hours.



Caution Do not put a damp filter back in the ONS 15454.

- Step 10** If the air filter should be installed in the external filter brackets, slide the air filter all the way to the back of the brackets to complete the procedure.

- Step 11** If the filter should be installed beneath the fan-tray assembly, remove the fan-tray assembly and slide the air filter into the recessed compartment at the bottom of the shelf assembly. Put the front edge of the air filter flush against the front edge of the recessed compartment. Push the fan tray back into the shelf assembly.



Caution If the fan tray does not slide all the way to the back of the shelf assembly, pull the fan tray out and readjust the position of the reusable filter until the fan tray fits correctly.



Note On a powered-up ONS 15454, the fans start immediately after the fan-tray assembly is correctly inserted.

- Step 12** To verify that the tray is plugged into the backplane, ensure that the LCD on the front of the fan-tray assembly is activated and displays node information.
- Step 13** Rotate the retractable handles back into their compartments.
- Step 14** Replace the door and reattach the ground strap.
-

Remove and Reinsert a Fan-Tray Assembly

-
- Step 1** Use the retractable handles embedded in the front of the fan-tray assembly to pull it forward several inches.
- Step 2** Push the fan-tray assembly firmly back into the ONS 15454.
- Step 3** Close the retractable handles.
-

Replace the Fan-Tray Assembly

**Caution**

The 15454-FTA3 fan-tray assembly can only be installed in ONS 15454 R3.1 and later shelf assemblies (15454-SA-ANSI, P/N: 800-19857; 15454-SA-HD, P/N: 800-24848). It includes a pin that does not allow it to be installed in ONS 15454 shelf assemblies released before ONS 15454 R3.1 (15454-SA-NEBS3E, 15454-SA-NEBS3, and 15454-SA-R1, P/N: 800-07149). Equipment damage can result from attempting to install the 15454-FTA3 in a incompatible shelf assembly.

**Caution**

Do not force a fan-tray assembly into place. Doing so can damage the connectors on the fan tray and/or the connectors on the backplane.

**Caution**

Always use the supplied electrostatic discharge wristband when working with a powered ONS 15454. Plug the wristband cable into the ESD jack located on the lower-right edge of the shelf assembly.

To replace the fan-tray assembly, it is not necessary to move any of the cable management facilities.

- Step 1** Open the front door of the shelf assembly by completing the following steps. If the shelf assembly does not have a front door, continue with [Step 3](#).
- Open the front door lock.
 - Press the door button to release the latch.
 - Swing the door open.
- Step 2** Remove the front door (optional):
- Detach the ground strap from either the door or the chassis by removing one of the Kepnuts.
 - Place the Kepnut back on the stud after the ground strap is removed to avoid misplacement.
 - Secure the dangling end of the ground strap to the door or chassis with tape.
- Step 3** Push the outer side of the handles on the fan-tray assembly to expose the handles.
- Step 4** Fold out the retractable handles at the outside edges of the fan tray.
- Step 5** Pull the handles and slide the fan-tray assembly one inch (25.4 mm) out of the shelf assembly and wait until the fans stop.
- Step 6** When the fans have stopped, pull the fan-tray assembly completely out of the shelf assembly.
- Step 7** If you are replacing the fan-tray air filter and it is installed beneath the fan-tray assembly, slide the existing air filter out of the shelf assembly and replace it before replacing the fan-tray assembly.
- If you are replacing the fan-tray air filter and it is installed in the external bottom bracket, you can slide the existing air filter out of the bracket and replace it at anytime. For more information on the fan-tray air filter, see the [“Inspect, Clean, and Replace the Reusable Air Filter”](#) section on page 2-279.
- Step 8** Slide the new fan tray into the shelf assembly until the electrical plug at the rear of the tray plugs into the corresponding receptacle on the backplane.
- Step 9** To verify that the tray has plugged into the backplane, check that the LCD on the front of the fan tray is activated.

Step 10 If you replace the door, be sure to reattach the ground strap.

2.9.7 Interface Procedures

This section includes instructions for replacing an EIA and an AIP.

Replace the Electrical Interface Assembly



Note You need a #2 Phillips screwdriver. If you use high-density BNC EIAs, you also need a BNC insertion and removal tool.

Step 1 To remove the lower backplane cover, loosen the five screws that secure it to the ONS 15454 and pull it away from the shelf assembly.

Step 2 Loosen the nine perimeter screws that hold the backplane sheet metal cover or EIA in place. Do not remove the interior screws.

If you are removing an AMP Champ EIA, remove the fastening plate before proceeding. To remove the fastening plate, loosen the two thumbscrews.

Step 3 If a backplane cover is attached to the ONS 15454, lift the panel by the bottom to remove it from the shelf assembly and store the panel for later use.

Step 4 If an EIA is attached to the ONS 15454, lift the EIA handles and gently pull it away from the backplane.



Note Attach backplane sheet metal covers whenever EIAs are not installed.

Step 5 Line up the connectors on the new EIA with the mating connectors on the backplane.

Step 6 Gently push the EIA until both sets of connectors fit together snugly.

Step 7 Replace the nine perimeter screws that you removed while removing the backplane cover.

Step 8 If you are installing an AMP Champ EIA, attach the fastening plate with the two thumbscrews.

Step 9 Reattach the lower backplane cover.

Replace the Alarm Interface Panel



Caution Do not use a 2A AIP with a 5A fan-tray assembly; doing so causes a blown fuse on the AIP.



Caution If any nodes in an Ethernet circuit are not using Software R4.0 or later, there is a risk of Ethernet traffic disruptions. Contact Cisco TAC at 1 800 553-2447 when prompted to do so in the procedure.

**Note**

Perform this procedure during a maintenance window. Resetting the active TCC2/TCC2P can cause a service disruption of less than 50 ms to OC-N or DS-N traffic. Resetting the active TCC2/TCC2P can cause a service disruption of 3 to 5 minutes on all Ethernet traffic due to spanning tree reconvergence if any nodes in the Ethernet circuit are not using Software R4.0 or later.

**Caution**

Do not perform this procedure on a node with live traffic. Hot-swapping the AIP can affect traffic and result in a loss of data. For assistance with AIP replacement contact Cisco TAC 1 800 553-2447.

**Caution**

Always use the supplied electrostatic discharge wristband when working with a powered ONS 15454. Plug the wristband cable into the ESD jack located on the lower-right edge of the shelf assembly.

This procedure replaces an existing AIP with a new AIP on an in-service node without affecting traffic. Ethernet circuits that traverse nodes with a software release prior to R4.0 is affected.

You need a #2 Phillips screwdriver.

Step 1 Ensure that all nodes in the affected network are running the same software version before replacing the AIP and repairing circuits:

- a. In network view, click the **Maintenance > Software** tabs. The working software version for each node is listed in the Working Version column.
- b. If you need to upgrade the software on a node, refer to the release-specific software upgrade document for procedures. No hardware should be changed or circuit repair performed until after the software upgrade is complete. If you do not need to upgrade software or have completed the software upgrade, proceed to [Step 2](#).

Step 2 Record the MAC address of the old AIP:

- a. Log into the node where you are replacing the AIP. For login procedures, refer to the “Connect the PC and Log into the GUI” chapter in the *Cisco ONS 15454 Procedure Guide*.
- b. In node view, click the **Provisioning > Network > General** tabs.
- c. Record the MAC address.

Step 3 Call Cisco TAC 1 800 553-2447 for assistance in replacing the AIP and maintaining the original MAC address.

Step 4 Unscrew the five screws that hold the lower backplane cover in place.

Step 5 Grip the lower backplane cover and gently pull it away from the backplane.

Step 6 Unscrew the two screws that hold the AIP cover in place.

Step 7 Grip the cover and gently pull away from the backplane.

**Note**

On the 15454-SA-HD (P/N: 800-24848), 15454-SA-NEBS3E, 15454-SA-NEBS3, and 15454-SA-R1 (P/N: 800-07149) shelves the AIP cover is clear plastic. On the 15454-SA-ANSI shelf (P/N: 800-19857), the AIP cover is metal.

Step 8 Grip the AIP and gently pull it away from the backplane.

Step 9 Disconnect the fan-tray assembly power cable from the AIP.

Step 10 Set the old AIP aside for return to Cisco.

**Caution**

The type of shelf the AIP resides in determines the version of AIP that should replace the failed AIP. The 15454-SA-ANSI shelf (P/N: 800-19857) and 15454-SA-HD (P/N: 800-24848) currently use the 5A AIP, (P/N: 73-7665-01). The 15454-SA-NEBS3E, 15454-SA-NEBS3, and 15454-SA-R1 (P/N: 800-07149) shelves and earlier use the 2A AIP (P/N: 73-5262-01).

**Caution**

Do not put a 2A AIP (P/N: 73-5262-01) into a 15454-SA-ANSI (P/N: 800-19857) or 15454-SA-HD (P/N: 800-24848) shelf; doing so causes a blown fuse on the AIP.

Step 11 Attach the fan-tray assembly power cable to the new AIP.

Step 12 Place the new AIP on the backplane by plugging the panel into the backplane using the DIN connector.

Step 13 Replace the AIP cover over the AIP and secure the cover with the two screws.

Step 14 Replace the lower backplane cover and secure the cover with the five screws.

Step 15 In node view, click the **Provisioning > Network** tabs.

**Caution**

Cisco recommends TCC2/TCC2P resets be performed in a maintenance window to avoid any potential service disruptions.

Step 16 Reset the standby TCC2/TCC2P:

- a. Right-click the standby TCC2/TCC2P and choose **Reset Card**.
- b. Click **Yes** in the Resetting Card dialog box. As the card resets, a loading (Ldg) indication appears on the card in CTC. The reset takes approximately five minutes. Do not perform any other steps until the reset is complete.

Step 17 Reset the active TCC2/TCC2P:

- a. Right click the active TCC2/TCC2P and choose **Reset Card**.
- b. Click **Yes** in the Resetting Card dialog box. As the card resets, a Ldg indication appears on the card in CTC. The reset takes approximately five minutes and CTC loses its connection with the node.

Step 18 From the **File** drop-down list, choose **Exit** to exit the CTC session.

Step 19 Log back into the node. At the Login dialog box, choose **(None)** from the Additional Nodes drop-down list.

Step 20 Record the new MAC address:

- a. In node view, click the **Provisioning > Network > General** tabs.
- b. Record the MAC address.

Step 21 In node view, click the **Circuits** tab. Note that all circuits listed are PARTIAL.

Step 22 In node view, choose **Repair Circuits** from the **Tools** drop-down list. The Circuit Repair dialog box appears.

Step 23 Read the instructions in the Circuit Repair dialog box. If all the steps in the dialog box have been completed, click **Next**. Ensure that you have the old and new MAC addresses.

Step 24 The Node MAC Addresses dialog box appears. Complete the following steps:

- a. From the Node drop-down list, choose the name of the node where you replaced the AIP.

- b. In the Old MAC Address field, enter the old MAC address that was recorded in [Step 2](#).
- c. Click **Next**.

Step 25 The Repair Circuits dialog box appears. Read the information in the dialog box and click **Finish**.

The CTC session freezes until all circuits are repaired. Circuit repair can take up to five minutes or more depending on the number of circuits provisioned on it.

When the circuit repair is complete, the Circuits Repaired dialog box appears.

Step 26 Click **OK**.

Step 27 In the node view of the new node, click the **Circuits** tab. Note that all circuits listed are DISCOVERED. If all circuits listed do not have a DISCOVERED status, call the Cisco TAC 1 800 553-2447 to open a Return Material Authorization (RMA).



Transient Conditions

This chapter gives a description, entity, SNMP number, and trap for each commonly encountered Cisco ONS 15454 transient condition.

3.1 Transients Indexed By Alphabetical Entry

Table 3-1 alphabetically lists all ONS 15454 transient conditions and their entity, SNMP number, and SNMP trap.



Note

The CTC default alarm profile might contain conditions that are not currently implemented but are reserved for future use.

Table 3-1 ONS 15454 Transient Condition Alphabetical Index

Transient Condition	Entity	SNMP Number	SNMP Trap
3.3.1 ADMIN-DISABLE, page 3-4	NE	5270	disableInactiveUser
3.3.2 ADMIN-DISABLE-CLR, page 3-4	NE	5280	disableInactiveClear
3.3.3 ADMIN-LOCKOUT, page 3-4	NE	5040	adminLockoutOfUser
3.3.4 ADMIN-LOCKOUT-CLR, page 3-4	NE	5050	adminLockoutClear
3.3.5 ADMIN-LOGOUT, page 3-5	NE	5020	adminLogoutOfUser
3.3.6 ADMIN-SUSPEND, page 3-5	NE	5340	suspendUser
3.3.7 ADMIN-SUSPEND-CLR, page 3-5	NE	5350	suspendUserClear
3.3.8 AUD-ARCHIVE-FAIL, page 3-5	EQPT	6350	archiveOfAuditLogFailed
3.3.9 AUTOWDMANS, page 3-5	NE	5690	automaticWdmAnsFinished
3.3.10 BLSR-RESYNC, page 3-5	OCN	2100	blsrMultiNodeTableUpdateCompleted
3.3.11 DBBACKUP-FAIL, page 3-5	EQPT	3724	databaseBackupFailed
3.3.12 DBRESTORE-FAIL, page 3-6	EQPT	3726	databaseRestoreFailed

Table 3-1 ONS 15454 Transient Condition Alphabetical Index (continued)

Transient Condition	Entity	SNMP Number	SNMP Trap
3.3.13 EFM-ERR-FRM, page 3-6	ML100T, ML1000, MLFX, ML2	6800	efmLinkMonitoringError edFrameEvent
3.3.14 EFM-FRM-PER, page 3-6	ML100T, ML1000, MLFX, ML2	6810	efmLinkMonitoringError edFramePeriodEvent
3.3.15 EFM-FRM-SEC, page 3-6	ML100T, ML1000, MLFX, ML2	6820	efmLinkMonitoringError edFrameSecondsSummar y
3.3.16 EFM-RLBK-FAIL, page 3-6	ML100T, ML1000, MLFX, ML2	6830	efmRemoteLoopbackReq uestFailed
3.3.17 EFM-SYM-PER, page 3-7	ML100T, ML1000, MLFX, ML2	6790	efmLinkMonitoringError edSymbolPeriodEvent
3.3.18 FIREWALL-DIS, page 3-7	NE	5230	firewallHasBeenDisabled
3.3.19 FRCDWKS WBK-NO-TRFSW, page 3-7	OCN	5560	forcedSwitchBackToWor kingResultedInNoTraffic Switch
3.3.20 FRCDWKS WPR-NO-TRFSW, page 3-7	OCn	5550	forcedSwitchToProtectRe sultedInNoTrafficSwitch
3.3.21 INTRUSION, page 3-7	NE	5250	securityIntrusionDetUser
3.3.22 IOSCFG-COPY-FAIL, page 3-7	—	3660	iosConfigCopyFailed
3.3.23 LOGIN-FAIL-LOCKOUT, page 3-8	NE	5080	securityInvalidLoginLock edOutSeeAuditLog
3.3.24 LOGIN-FAIL-ONALRDY, page 3-8	NE	5090	securityInvalidLoginAlre adyLoggedOnSeeAuditLo g
3.3.25 LOGIN-FAILURE-PSWD, page 3-8	NE	5070	securityInvalidLoginPass wordSeeAuditLog
3.3.26 LOGOUT-IDLE-USER, page 3-8	—	5110	automaticLogoutOfIdleU ser
3.3.27 MANWKS WBK-NO-TRFSW, page 3-8	OCN	5540	manualSwitchBackToWor kingResultedInNoTraffic Switch
3.3.28 MANWKS WPR-NO-TRFSW, page 3-8	OCN	5530	manualSwitchToProtectR esultedInNoTrafficSwitch

Table 3-1 ONS 15454 Transient Condition Alphabetical Index (continued)

Transient Condition	Entity	SNMP Number	SNMP Trap
3.3.29 PM-TCA, page 3-8	—	2120	performanceMonitorThresholdCrossingAlert
3.3.30 PS, page 3-9	EQPT	2130	protectionSwitch
3.3.31 RMON-ALARM, page 3-9	—	2720	rmonThresholdCrossingAlarm
3.3.32 RMON-RESET, page 3-9	—	2710	rmonHistoriesAndAlarmsResetReboot
3.3.33 SFTWDOWN-FAIL, page 3-9	EQPT	3480	softwareDownloadFailed
3.3.34 USER-LOCKOUT, page 3-9	NE	5030	userLockedOut
3.3.35 USER-LOGIN, page 3-9	NE	5100	loginOfUser
3.3.36 USER-LOGOUT, page 3-9	NE	5120	logoutOfUser
3.3.37 WKSWBK, page 3-10	EQPT, OCN	2640	switchedBackToWorking
3.3.38 WKSWPR, page 3-10	2R, TRUNK, EQPT, ESCON, FC, GE, ISC, OCN, STSMON, VT-MON	2650	switchedToProtection
3.3.39 WTR-SPAN, page 3-10	—	3420	spanIsInWaitToRestoreState

3.2 Trouble Notifications

The ONS 15454 system reports trouble by using standard condition characteristics that follow the rules in Telcordia GR-253 and graphical user interface (GUI) state indicators.

The ONS 15454 uses standard Telcordia categories to characterize levels of trouble. The system reports trouble notifications as alarms and reports status or descriptive notifications (if configured to do so) as conditions in the CTC Alarms window. Alarms typically signify a problem that you need to remedy, such as a loss of signal. Conditions do not necessarily require troubleshooting.

3.2.1 Condition Characteristics

Conditions include any problem detected on an ONS 15454 shelf. They can include standing or transient notifications. You can retrieve a snapshot of all currently raised conditions on the network, node, or card in the CTC Conditions window or by using the RTRV-COND commands in TL1.

Note

Some cleared conditions are found on the History tab.

For a comprehensive list of conditions, refer to the *Cisco ONS SONET TL1 Command Guide*.

3.2.2 Condition States

The History tab state (ST) column indicates the disposition of the condition, as follows:

- A raised (R) event is active.
- A cleared (C) event is no longer active.
- A transient (T) event is automatically raised and cleared in CTC during system changes such as user login, log out, and loss of connection to node view. Transient events do not require user action.

3.3 Transient Conditions

This section lists in alphabetical order all the transient conditions encountered in Software Release 7.2. The description, entity, SNMP number, and SNMP trap accompany each condition.

3.3.1 ADMIN-DISABLE

The Disable Inactive User (ADMIN-DISABLE) condition occurs when the administrator disables the user or the account is inactive for a specified period.

This transient condition does not result in a standing condition.

3.3.2 ADMIN-DISABLE-CLR

The Disable Inactive Clear (ADMIN-DISABLE-CLR) condition occurs when the administrator clears the disable flag on the user account.

This transient condition does not result in a standing condition.

3.3.3 ADMIN-LOCKOUT

The Admin Lockout of User (ADMIN-LOCKOUT) condition occurs when the administrator locks a user account.

This transient condition does not result in a standing condition.

3.3.4 ADMIN-LOCKOUT-CLR

The Admin Lockout Clear (ADMIN-LOCKOUT-CLR) condition occurs when the administrator unlocks a user account or the lockout time expires.

This transient condition does not result in a standing condition.

3.3.5 ADMIN-LOGOUT

The Admin Logout of User (ADMIN-LOGOUT) condition occurs when the administrator logs off a user session.

This transient condition does not result in a standing condition.

3.3.6 ADMIN-SUSPEND

The Suspend User (ADMIN-SUSPEND) condition occurs when the password for a user account expires.

This transient condition does not result in a standing condition.

3.3.7 ADMIN-SUSPEND-CLR

The Suspend User Clear (ADMIN-SUSPEND-CLR) condition occurs when the user or administrator changes the password.

This transient condition does not result in a standing condition.

3.3.8 AUD-ARCHIVE-FAIL

The Archive of Audit Log Failed (AUD-ARCHIVE-FAIL) condition occurs when the software cannot archive the audit log. The condition normally occurs when the user refers to an FTP server that does not exist, or uses an invalid login when trying to archive. The user must log in again with correct user name, password, and FTP server details.

This transient condition does not result in a standing condition.

3.3.9 AUTOWDMANS

The Automatic WDM ANS Finish (AUTOWDMANS) condition indicates that an automatic node setup command has been initiated. It normally occurs when you replace DWDM cards; the condition is an indication that the system has regulated the card.

This transient condition does not result in a standing condition.

3.3.10 BLSR-RESYNC

The BLSR Multinode Table Update Completed (BLSR-RESYNC) condition might occur when you create or delete circuits on a bidirectional line switched ring (BLSR), change a ring topology (for example, add or delete a BLSR node), or change the BLSR circuit state and ring ID.

This transient condition does not result in a standing condition.

3.3.11 DBBACKUP-FAIL

The Database Backup Failed (DBBACKUP-FAIL) condition occurs when the system fails to back up the database when the backup command is initiated.

This condition can occur when the server is not able to handle the backup operation due to network or server issues. Repeat the same operation again and check to see if it is successful. If the backup fails, it could be due to a network issue or software program failure.

3.3.12 DBRESTORE-FAIL

The Database Restore Failed (DBRESTORE-FAIL) condition occurs when the system fails to restore the backed up database when the restore command is initiated.

This condition can be due to server issues, network issues, or human error (pointing to a file that does not exist, wrong file name, etc.). Retrying the database restore with the correct file will usually succeed. If the network issue persists, you must contact network lab support. If the condition is caused by a network element (NE) failure, contact TAC for assistance.

3.3.13 EFM-ERR-FRM

The EFM Link Monitoring - Errored Frame Event condition occurs when the number of error frames detected on the remote NE is equal to or greater than the specified threshold for a specified period, and the remote NE notifies local NE of the same. A period is specified by time interval.

This transient condition does not result in a standing condition.

3.3.14 EFM-FRM-PER

The EFM Link Monitoring - Errored Frame Period Event condition occurs when the number of errored frames detected on the remote NE is equal to or greater than the specified threshold for a specified period, and the remote NE notifies local NE of the same. A period is specified by the number of received frames.

This transient condition does not result in a standing condition.

3.3.15 EFM-FRM-SEC

The EFM Link Monitoring - Errored Frame Seconds Summary condition occurs when the number of errored frame seconds (a 1-second interval wherein at least one frame error was detected) on the remote NE crosses the configured threshold. The remote NE notifies local NE of the condition.

3.3.16 EFM-RLBK-FAIL

The EFM - Remote Loopback Request Failed condition occurs when a request fails. When the user triggers a remote loopback request on the local NE, the request is forwarded to the remote NE. If the remote NE does not respond to the request and the local NE times out, this condition notifies the user on local NE about the failure.

This transient condition does not result in a standing condition.

3.3.17 EFM-SYM-PER

The EFM Link Monitoring - Errored Symbol Period Event condition occurs when the symbol errors detected at the remote NE cross a configured threshold. This condition notifies the user on the local NE of this threshold crossing.

This transient condition does not result in a standing condition.

3.3.18 FIREWALL-DIS

The Firewall Has Been Disabled (FIREWALL-DIS) condition occurs when you provision the firewall to Disabled.

This transient condition does not result in a standing condition.

3.3.19 FRCDWKSWBK-NO-TRFSW

The Forced Switch Back to Working Resulted in No Traffic Switch (FRCDWKSWBK-NO-TRFSW) condition occurs when you perform a Force Switch to the working port/card and the working port/card is already active.

This transient condition might result in a Force Switch (Ring or Span) standing condition for a BLSR.

3.3.20 FRCDWKSWPR-NO-TRFSW

The Forced Switch to Protection Resulted in No Traffic Switch (FRCDWKSWPR-NO-TRFSW) condition occurs when you perform a Force Switch to the protect port/card, and the protect port/card is already active.

This transient condition does not result in a standing condition.

3.3.21 INTRUSION

The Invalid Login Username (INTRUSION) condition occurs when you attempt to login with an invalid user ID.

This transient condition does not result in a standing condition.

3.3.22 IOSCFG-COPY-FAIL

The IOS Config Copy Failed (IOSCFG-COPY-FAIL) condition occurs on ML-Series Ethernet cards when the software fails to upload or download the Cisco IOS startup configuration file to or from an ML-Series card. This condition is similar to the [“SFTWDOWN-FAIL” condition on page 3-9](#), but the IOSCFG-COPY-FAIL condition applies to ML-Series Ethernet cards rather than the TCC2/TCC2P card.

3.3.23 LOGIN-FAIL-LOCKOUT

The Invalid Login–Locked Out (LOGIN-FAIL-LOCKOUT) condition occurs when you attempt to log into a locked account.

This transient condition does not result in a standing condition.

3.3.24 LOGIN-FAIL-ONALRDY

The Security: Invalid Login–Already Logged On (LOGIN-FAIL-ONALRDY) condition occurs when you attempt to log in to a node where the user already has an existing session and a Single-User-Per-Node (SUPN) policy exists.

This transient condition does not result in a standing condition.

3.3.25 LOGIN-FAILURE-PSWD

The Invalid Login–Password (LOGIN-FAILURE-PSWD) condition occurs when you attempt to login with an invalid password.

This transient condition does not result in a standing condition.

3.3.26 LOGOUT-IDLE-USER

The Automatic Logout of Idle User (LOGOUT-IDLE-USER) condition occurs when a user session is idle for too long (the idle timeout expires) and the session terminates as a result. You must log in again to restart your session.

3.3.27 MANWKSWBK-NO-TRFSW

The Manual Switch Back To Working Resulted in No Traffic Switch (MANWKSWBK-NO-TRFSW) condition occurs when you perform a Manual switch to the working port/card and the working port/ card is already active.

This transient condition does not result in a standing condition.

3.3.28 MANWKSWPR-NO-TRFSW

The Manual Switch to Protect Resulted in No Traffic Switch (MANWKSWPR-NO-TRFSW) condition occurs when you perform a Manual switch to the protect port/card and the protect port/card is already active.

This transient condition results in a BLSR Manual Switch (Span or Ring) standing condition.

3.3.29 PM-TCA

The Performance Monitor Threshold Crossing Alert (PM-TCA) condition occurs when network collisions cross the rising threshold for the first time.

3.3.30 PS

The Protection Switch (PS) condition occurs when the traffic switches from a working/active card to a protect/standby card.

3.3.31 RMON-ALARM

The RMON Threshold Crossing Alarm (RMON-ALARM) condition occurs when the remote monitoring variable crosses the threshold.

3.3.32 RMON-RESET

The RMON Histories and Alarms Reset Reboot (RMON-RESET) condition occurs when the time-of-day settings on the TCC2/TCC2P card are increased or decreased by more than five seconds. This invalidates all the history data and remote monitoring (RMON) must restart. It can also occur when you reset a card.

3.3.33 SFTWDOWN-FAIL

The Software Download Failed (SFTDOWN-FAIL) condition occurs when the system fails to download the required software.

An incorrect input that points to the wrong place or file, network issues, or a bad (corrupt) package can cause this failure. Retrying the operation with the correct name/location will usually succeed. If network issues persist, you must contact the network lab support. If the package is corrupt, contact Cisco TAC.

3.3.34 USER-LOCKOUT

The User Locked Out (USER-LOCKOUT) condition occurs when the system locks an account because of a failed login attempt. To proceed, the administrator must unlock the account or the lockout time must expire.

3.3.35 USER-LOGIN

The Login of User (USER-LOGIN) occurs when you begin a new session by verifying your User ID and password.

This transient condition does not result in a standing condition.

3.3.36 USER-LOGOUT

The Logout of User (USER-LOGOUT) condition occurs when you stop a login session by logging out of your account.

This transient condition does not result in a standing condition.

3.3.37 WKSWBK

The Switched Back to Working (WKSWBK) condition occurs when traffic switches back to the working port/card in a non-revertive protection group.

This transient condition does not result in a standing condition.

3.3.38 WKSWPR

The Switched to Protection (WKSWPR) condition occurs when traffic switches to the protect port/card in a non-revertive protection group. This transient condition does not result in a standing condition. The (WKSWPR) is raised as a standing condition in a revertive protection group.

The Switched to Protection (WKSWPR) condition also occurs after the protection switch in a 1+1 non-revertive protection group as a transient condition. When the protection group is changed to revertive, the (WKSWPR) is not raised as a standing condition or as a new transient condition. However, after a protection switch in a 1:1 protection group, the user will not be allowed to configure the protection group from non-revertive to revertive.

3.3.39 WTR-SPAN

The Span is in Wait To Restore State (WTR-SPAN) condition occurs when a BLSR switches to another span due to a Signal Failure-Span command or a fiber is pulled from a four-fiber BLSR configuration. The condition is raised until the WaitToRestore (WTR) period expires.

This transient condition clears when the BLSR returns to a normal condition or the IDLE state.



Error Messages

This chapter lists the Cisco ONS 15454, Cisco 15454 SDH, Cisco ONS 15600, Cisco 15600 SDH, Cisco ONS 15310-CL, and Cisco ONS 15310-MA error messages. The error dialog box in [Figure 4-1](#) consists of three parts: the error title, error ID, and error message. The table lists two types of messages: error messages (EID-*nnnn*) and warning messages (WID-*nnnn*). Error messages are alerts that an unexpected or undesirable operation has occurred which either indicates the risk of loss of traffic or an inability to properly manage devices in the network. Warnings are alerts that the requested operation could lead to an error. Warnings are sometimes used to convey important information.

Figure 4-1 Error Dialog Box

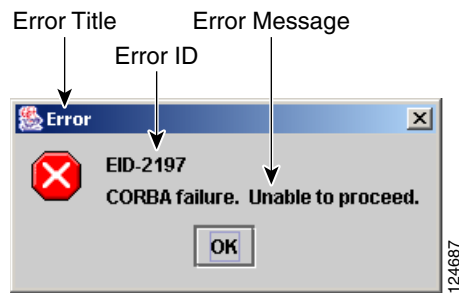

[Table 4-1](#) gives a list of all error or warning message numbers, the messages, and a brief description of each message.

Table 4-1 Error Messages

Error Warning ID	Error Warning Message	Description
EID-0	Invalid error ID.	The error ID is invalid.
EID-1	A null pointer encountered in {0}.	Cisco Transport Controller (CTC) encountered a null pointer in the area described by the specified item.
EID-1000	The host name of the network element cannot be resolved to an address.	Refer to the error message text.

Table 4-1 Error Messages (continued)

Error Warning ID	Error Warning Message	Description
EID-1001	Unable to launch CTC due to applet security restrictions. Please review the installation instructions to make sure that the CTC launcher is given the permissions it needs. Note that you must exit and restart your browser in order for the new permissions to take effect.	Refer to the error message text.
EID-1002	The host name (e.g., for the network element) was successfully resolved to its address, but no route can be found through the network to reach the address.	The node is not reachable from CTC client station.
EID-1003	An error was encountered while attempting to launch CTC. {0}	Unexpected exception or error while launching CTC from the applet.
EID-1004	Problem Deleting CTC Cache: {0} {1}	Unable to delete the CTC cached JARs, because another application may have the JAR files running; for example, another instance of CTC.
EID-1005	An error occurred while writing to the {0} file.	CTC encountered an error while writing to log files, preference files, etc.
EID-1006	The URL used to download {0} is malformed.	The URL used to download the specified JAR file is incorrect.
EID-1007	An I/O error occurred while trying to download {0}.	An input or output exception was encountered when CTC tried to download the specified JAR file.
EID-1018	Password shall not contain the associated user-ID.	The password is invalid.
EID-1019	Could not create {0}. Please enter another filename.	CTC could not create the file due to an invalid filename.
EID-1020	Fatal exception occurred, exiting CTC. Unable to switch to the Network view.	CTC was unable to switch from the node or card view to the network view and is now shutting down.
EID-1021	Unable to navigate to {0}.	CTC could not display the requested view (node or network).
EID-1022	An IOS session cannot be opened right now with this slot. Most likely someone else (using a different CTC) already has a session opened with this slot. Please try again later.	Refer to the error message text. Ensure that the shell access in CTC (Provisioning>Security>Access) is set to non-secure mode.
EID-1023	This IOS session has been terminated. Terminations are caused when the session has timed out, the card resets, there is already a session with the slot, or password configuration is required.	Refer to the error message text.
EID-1025	Unable to create Help Broker.	CTC was unable to create the help broker for the online help.
EID-1026	Error found in the Help Set file.	CTC encountered an error in the online help file.

Table 4-1 **Error Messages (continued)**

Error Warning ID	Error Warning Message	Description
EID-1027	Unable to locate help content for Help ID: "{0}".	CTC was unable to locate the content for the help ID.
EID-1028	Error saving table. {0}	There was an error while saving the specified table.
EID-1031	CTC cannot locate the online user manual files. The files may have been moved, deleted, or not installed. To install online user manuals, run the CTC installation wizard on the software or documentation CD.	Refer to the error message text.
EID-1032	CTC cannot locate Acrobat Reader. If Acrobat Reader is not installed, you can install the Reader using the CTC installation wizard provided on the software or documentation CD.	Refer to the error message text.
EID-1035	CTC experienced an I/O error while working with the log files. Usually this means that the computer has run out of disk space. This problem may or may not cause CTC to stop responding. Ending this CTC session is recommended, but not required.	Refer to the error message text.
WID-1036	WARNING: Deleting the CTC cache may cause any CTC running on this system to behave in an unexpected manner.	Refer to the warning message text.
EID-1037	Could not open {0}. Please enter another filename.	Invalid file name. CTC is unable to open the specified file. Ensure that the file exists and the filename was typed correctly.
EID-1038	The file {0} does not exist.	The specified file does not exist.
EID-1039	The version of the browser applet does not match the version required by the network element. Please close and restart your browser in order to launch the Cisco Transport Controller.	Refer to the error message text.
WID-1041	An error occurred while closing the {0} connection.	CTC encountered an error while closing the specified connection.
WID-1042	You have selected Java version {0}. This version is outside of the recommended range and may cause an unpredictable behavior of the software. Do you wish to continue?	Refer to the warning message text.
EID-1043	Error writing to file: {0}. This might be caused by a directory permission, quota or disk volume full issue.	Check for possible causes and try again.
WID-1044	Warning: there is a discrepancy in the build timestamp between the NE cached jar file ({0}) and the NE ({1}). Your CTC jar cache should be emptied.	Refer to the warning message text.
EID-2001	No rolls were selected. {0}	No rolls were selected for the bridge and roll.
EID-2002	The roll must be completed or canceled before it can be deleted.	You cannot delete the roll unless it has been completed or cancelled.
EID-2003	An error occurred while deleting the roll. {0}	There was an error when CTC tried to delete the roll.

Table 4-1 Error Messages (continued)

Error Warning ID	Error Warning Message	Description
EID-2004	No Cisco IOS slot was selected.	You did not select a Cisco IOS slot.
EID-2005	CTC cannot find the online help files for {0}. The files might have been moved, deleted, or not installed. To install online help, run the setup program on the software CD.	CTC cannot find the online help files for the specified window. The files might have been moved, deleted, or not installed. To install online help, run the setup program on the software CD.
EID-2006	An error occurred while editing the circuit(s). {0} {1}.	An error occurred when CTC tried to open the circuit for editing.
EID-2007	The preferences could not be saved.	CTC cannot save the preferences.
EID-2008	The circuit preferences could not be saved: {0}	CTC cannot find the file needed to save the circuit preferences.
EID-2009	CTC was unable to download the package: {0}	Refer to the error message text.
EID-2010	An error occurred while deleting the destination.	CTC could not delete the destination.
EID-2011	The circuit could not be destroyed.	CTC could not destroy the circuit.
EID-2012	The reverse circuit could not be destroyed.	CTC could not reverse the circuit destroy.
EID-2013	The circuit creation failed. The circuit creation cannot proceed due to changes in the network which affected the circuit(s) being created. The dialog box will close. Please try again.	Refer to the error message text.
EID-2014	No circuit(s) were selected. {0}	You must select a circuit to complete this function.
EID-2015	The circuit {0} cannot be deleted because it has one or more rolls.	You must delete the rolls in the circuit before deleting the circuit itself.
EID-2016	The circuit deletion failed.	CTC could not delete the tunnel as there are circuits that use the tunnel.
EID-2017	An error occurred while mapping the circuit. {0}	There was an error mapping the circuit.
EID-2018	The circuit roll failed. The circuit must be in the DISCOVERED state in order to perform a roll.	There was a failure in circuit roll. Change the circuit state to DISCOVERED and proceed.
EID-2019	The circuit roll failed. Bridge and roll is not supported on DWDM circuits.	Refer to the error message text.
EID-2020	The circuit roll failed. The two circuits must have the same direction.	Refer to the error message text.
EID-2021	The circuit roll failed. The two circuits must have the same size.	Refer to the error message text.
EID-2022	The circuit roll failed. A maximum of two circuits can be selected for a bridge and roll operation.	Refer to the error message text.

Table 4-1 **Error Messages (continued)**

Error Warning ID	Error Warning Message	Description
EID-2023	CTC was unable to create a new user account.	Refer to the error message text.
EID-2024	An error occurred during node selection.	There was an error during node selection.
EID-2025	This feature cannot be used. Verify that each endpoint of this circuit is running software that supports this feature.	Refer to the error or warning message text. For example, this error is generated from the node view Provisioning> WDM-ANS> tabs to indicate that the selected ring type is not supported by the endpoints of the circuit. Another example is the Provisioning> VLAN tabs in card view (Ethernet card only), where it indicates that the back-end spanning tree protocol (STP) disabling is not supported.
EID-2026	The {0} request could not be applied. {1}	Error occurred while attempting to switch a path protection circuit away from a span.
EID-2027	An error occurred while deleting the circuit drop.	CTC could not delete the circuit drop.
EID-2028	An error occurred while removing the circuit node.	CTC could not remove the circuit node.
EID-2029	The requested operation is not supported.	The task you are trying to complete is not supported by CTC.
EID-2030	An error occurred during provisioning.	There was an error during provisioning.
EID-2031	An error occurred while adding the node.	There was an error while adding a node.
EID-2032	The circuit could not be renamed. {0}	CTC could not rename the circuit.
EID-2033	An error occurred during validation. {0}	There was an internal error while validating the user changes after the Apply button was pressed. This error can occur in the Edit Circuit dialog box or in the BLSR table in the shelf view (rare condition).
EID-2034	Network circuits could not be added: {0}	Refer to the error message text.
EID-2035	The source and destination nodes are not connected.	Refer to the error message text.
EID-2036	The {0} cannot be deleted. LAN Access has been disabled on this node and this {0} is needed to access the node.	You cannot delete the DCC/GCC link as it is needed to access the node.
EID-2037	The attribute for {0} cannot be found.	CTC cannot find an attribute for the specified item.
EID-2038	The protection operation is invalid.	The protection operation you tried to execute is invalid.
EID-2040	Please select a node first.	You must select a node before performing the task.
EID-2041	No paths are available on this link. Please make another selection.	You must select a link that has paths available.

Table 4-1 Error Messages (continued)

Error Warning ID	Error Warning Message	Description
EID-2042	This span is not selectable. Only the green spans with an arrow may be selected.	Refer to the error message text.
EID-2043	This node is not selectable. Only the source node and nodes attached to included spans (blue) are selectable. Selecting a selectable node will enable its available outgoing spans.	Refer to the error message text.
EID-2044	This link may not be included in the required list. Constraints only apply to the primary path. Each node may have a maximum of one incoming signal and one outgoing link.	You must select only one link going in and out of a node. Selecting more than one link is contradictory to the path selection algorithm.
EID-2045	This link may not be included in the required list. Only one outgoing link may be included for each node.	Refer to the error message text.
EID-2047	Please enter a valid value for the slot number.	There was an error due to an invalid slot number.
EID-2048	Please enter a valid value for the port number.	There was an error due to an invalid port number.
EID-2050	The new circuit could not be destroyed.	CTC could not destroy the new circuit.
EID-2051	The circuit cannot be downgraded. {0}	The specified circuit cannot be downgraded.
EID-2052	An error occurred during circuit processing.	There was an error during the circuit processing.
EID-2054	An error occurred while selecting an endpoint.	There was an error during the endpoint selection.
EID-2055	No endpoints are available for this selection. Please make another selection.	This error occurs in the circuit creation dialog only during a race condition that has incorrectly allowed entities without endpoints to be displayed in the combination boxes.
EID-2056	A communication error occurred: {0}	An internal error occurred in Network Alarm tab while synchronizing alarms with the nodes.
EID-2059	An error occurred while deleting the node. {0}	There was an error during the node deletion.
EID-2060	No PCA circuits were found.	CTC could not find any protection channel access (PCA) circuits for this task.
EID-2061	An error occurred while provisioning the VLAN.	There was an error defining the VLAN.
EID-2062	An error occurred while deleting VLANs. No VLAN(s) were selected. Please select a VLAN.	Refer to the error message text.
EID-2063	The default VLAN cannot be deleted.	The selected VLAN is the default VLAN and cannot be deleted.
EID-2064	An error occurred while deleting VLANs. {0}	There was an error deleting the specified VLAN.

Table 4-1 Error Messages (continued)

Error Warning ID	Error Warning Message	Description
EID-2065	The profile cannot be imported. The profile "{0}" exists in the editor and the maximum number of copies (ten) exists in the editor. The import will be aborted. The profile has already been loaded eleven times.	Cannot import the profile because the profile has reached the maximum number of copies in the editor.
EID-2066	The profile could not be stored. An error occurred while writing to {0}.	CTC encountered an error while trying to store the profile.
EID-2067	An error occurred while writing to the file. {0}	CTC encountered an error while writing the specified file.
EID-2068	The alarm profile could not be loaded from the node.	CTC encountered an error trying to load the alarm profile from the node.
EID-2069	The file could not be found or an I/O exception occurred. {0}	Either the specified file was not found, or there was an input/output exception.
EID-2070	The profile could not be deleted. {0}	There was a failure in deleting the specified profile.
EID-2071	Only one column may be highlighted.	You cannot select more than one column during clone action.
EID-2072	Only one profile may be highlighted.	You cannot select more than one profile.
EID-2073	This column is permanent and cannot be removed.	You cannot delete a permanent column.
EID-2074	Select one or more profiles.	You have not selected any profile or column. Reset operation is done by right-clicking the selected column.
EID-2075	This column is permanent and cannot be reset.	Refer to the error message text.
EID-2077	This column is permanent and cannot be renamed.	Refer to the error message text.
EID-2078	At least two columns must be highlighted.	You cannot compare two profiles unless you select two columns.
EID-2079	The alarm types cannot be loaded into table. There are no reachable nodes from which the list of alarm types can be loaded. Please wait until such a node is reachable and try again.	Refer to the error message text.
EID-2080	The node {0} has no profiles.	The specified node does not have any profiles.
EID-2081	An error occurred while removing profile {0} from the node {1}.	There was an error while removing the specified profile from the specified node.
EID-2082	The profile {0} does not exist on the node {1}.	CTC cannot find the specified profile from the specified node.
EID-2083	An error occurred while adding profile {0} to the node {1}.	There was an error adding the specified profile to the specified node.
EID-2085	The profile selection is invalid. No profiles were selected.	You tried to select an invalid profile. Select another profile.

Table 4-1 Error Messages (continued)

Error Warning ID	Error Warning Message	Description
EID-2086	The node selection is invalid. No nodes were selected.	You tried to select an invalid node. Select another node.
EID-2087	No profiles were selected. Please select at least one profile.	Refer to the error message text.
EID-2088	The profile name is invalid.	The profile name cannot be empty.
EID-2089	Too many copies of {0} exist. Please choose another name.	Select a unique name.
EID-2090	No nodes were selected. Please select the node(s) on which to store the profile(s).	You must select one or more nodes on which you can store the profile.
EID-2091	Unable to switch to the node {0}.	CTC is unable to switch to the specified node.
EID-2092	A general exception error occurred.	CTC encountered a general exception error while trying to complete the task.
EID-2093	The name is too short. It does not have enough characters. {0}	The name must have a minimum of six characters.
EID-2094	The password and confirmed password fields do not match.	You must make sure the two fields have the same password.
EID-2095	The password is invalid. {0}	The password you entered is not allowed.
EID-2096	The user must have a security level.	You must have an assigned security level to perform this task.
EID-2097	No user name was specified.	You did not specify a user name.
EID-2099	An error occurred while ring switching.	There was an error during the ring switch.
EID-2100	Please select at least one profile to delete.	You have not selected the profile to delete.
EID-2101	An error occurred while protection switching.	There was an error during the protection switching.
EID-2102	The forced switch could not be removed for some circuits. You must switch these circuits manually.	The forced switch could not be removed for some circuits. You must switch these circuits manually.
EID-2103	An error occurred while upgrading the span.	There was an error during the span upgrade.
EID-2104	The circuits cannot be switched back because one or both nodes are not reachable.	This error occurs during the path protection span upgrade procedure.
EID-2106	The node name cannot be empty.	You must supply a name for the node.
EID-2107	An error occurred while adding {0}. The host is unknown.	There was an error adding the specified item.
EID-2108	{0} is already in the network.	The specified item exists in the network.
EID-2109	The node is already in the current login group.	The node you are trying to add is already present in the current login group.
EID-2110	Please enter a number between 0 and {0}.	You must enter a number in the range between 0 and the specified value.
EID-2111	This node ID is already in use. Please choose another.	Select a node ID that is not in use.

Table 4-1 Error Messages (continued)

Error Warning ID	Error Warning Message	Description
EID-2113	The extension byte for the ring cannot be set. {0}	CTC cannot set the BLSR/MS-SPRing extension byte.
EID-2114	A card communication failure occurred during the operation.	This error can occur during an attempt to apply a BLSR protection operation to a line.
EID-2115	An error occurred during the operation. {0}	There was an error in applying the specified operation.
EID-2116	The extension byte setting for the ring is invalid. {0}	The extension byte set for the specified ring is invalid.
EID-2118	The ring cannot be deleted. A protection operation is set. All protection operations must be clear for ring to be deleted.	Clear all the protection operations for the ring before deleting it.
EID-2119	{0} cannot be deleted because a protection switch is in effect. Please clear any protection operations, ensure that the reversion time is not "never" and allow any protection switches to clear before trying again.	Clear all protection operations or switches before deleting the ring.
EID-2120	The following nodes could not be unprovisioned {0} Therefore you will need to delete this {1} again later.	The specified nodes could not be unprovisioned. Try deleting this BLSR or MS-SPRing later.
EID-2121	The ring cannot be upgraded. {0}	CTC cannot upgrade the specified ring.
EID-2122	The ring speed for is inadequate for the upgrade procedure. Only {0} (or higher) {1} can be upgraded to four-fiber.	You have selected an incorrect ring speed for upgrade. Only rings within the specified parameters can be upgraded to 4-fiber BLSR.
EID-2123	Verify that the following nodes have at least two in-service ports with the same speed as the two-fiber {0}. The ports cannot serve as timing references, and they cannot have DCC terminations or overhead circuits. {1}	Nonupgradable nodes. Verify that the specified nodes have at least two IS-NR ports with the same speed as the 2-fiber BLSR. The specified ports cannot serve as a timing reference, and they cannot have data communications channel (DCC) terminations or overhead circuits.
EID-2124	You cannot add this span because it is connected to a node that already has the east and west ports defined.	Refer to the error message text.
EID-2125	You cannot add this span as it would cause a single card to host both the east span and the west span. A card cannot protect itself.	Refer to the error message text.
EID-2126	An error occurred while provisioning the OSPF area. {0}	There is an Open Shortest Path First (OSPF) area error.
EID-2127	You cannot add this span. It would cause the following circuit(s) to occupy different {0} regions on different spans: {1} Either select a different span or delete the above circuit(s).	A circuit cannot occupy different STS regions on different spans. You may add a different span or delete the specified circuit.

Table 4-1 Error Messages (continued)

Error Warning ID	Error Warning Message	Description
EID-2128	The state is invalid.	An internal error occurred while trying to remove a span from a BLSR. This alarm occurs in the network-level BLSR creation dialog box.
EID-2129	You cannot use same slot for east and west protect ports.	Refer to the error message text.
EID-2130	The ring ID value, {0}, is not valid. Please enter a valid number between 0 and 9999.	Enter a ring ID value between 0 and 9999.
EID-2131	The reversion cannot be set to INCONSISTENT.	You must select another reversion type.
EID-2135	The overhead circuit preferences could not be stored: {0}	Input/Output error. Unable to store overhead circuit preferences.
EID-2137	An error occurred during the circuit merge. {0}	There was an error while merging the circuits.
EID-2138	Not all destinations could be deleted. Please try again.	Refer to the error message text.
EID-2139	An error occurred while updating the destinations.	There was an error in updating the circuit destinations.
EID-2143	No online help version was selected. The online help book cannot be deleted.	Select the version of online help, and proceed.
EID-2144	An error occurred while deleting the online help book(s). {0}	You cannot delete the specified online help.
EID-2145	No nodes appear to have a Cisco IOS card.	Refer to error message.
EID-2146	This is a security violation. You may only logout of your own account.	You cannot logout of an account other than your own.
EID-2147	This is a security violation. You may only change your own account.	You cannot change an account other than your own.
EID-2148	This is a security violation. You cannot delete the account under which you are currently logged in.	You cannot delete the account you are currently logged in.
WID-2149	There is no exportable content in this view.	Refer to the error message text.
WID-2150	The node {0} is not initialized. Please wait and try again.	Wait till the specified node is initialized and try again.
WID-2152	Spanning tree protection is being disabled for this circuit.	Refer to the warning message text.
WID-2153	Adding this drop will make the circuit a PCA circuit.	Refer to the warning message text.
WID-2154	Monitor circuits cannot be created on a port grouping circuit.	Refer to the warning message text.
WID-2155	Switch counts might not be fully supported on some nodes. {0}	The specified nodes do not support switch counts completely.
WID-2156	The manual roll mode is recommended for dual rolls. For auto dual rolls, please verify that roll to facilities are in service and error-free.	Refer to the warning message text.

Table 4-1 Error Messages (continued)

Error Warning ID	Error Warning Message	Description
WID-2157	The roll(s) cannot be completed. {0}	CTC could not complete the roll because the roll is destroyed, in an incomplete state, in a TL1_roll state, is cancelled, or is not ready to complete.
EID-2158	The roll mode is invalid. {0}	There are two roll modes: auto and manual. For a one-way circuit source roll, the roll mode must be auto and for a one-way circuit destination roll, the roll mode must be manual.
EID-2159	The roll is not ready for completion. {0}	The roll is not ready for completion.
EID-2160	The roll is not connected. {0}	Refer to error message text.
EID-2161	The sibling roll is not complete. {0}	One of the rolls is not completed for the dual roll. If it is auto roll, it will be completed when a valid signal is detected. If it is a manual roll, you must complete the roll from CTC if Bridge and Roll is operated from CTC, or from TL1 if Bridge and Roll is operated from TL1.
EID-2162	An error occurred during roll acknowledgement. {0}	Refer to the error message text.
EID-2163	The roll cannot be canceled. {0}	CTC cannot cancel the roll.
EID-2164	An error occurred during the roll. {0}	CTC encountered a roll error.
WID-2165	The MAC address of the node {0} has been changed. All circuits originating from or dropping at this node will need to be repaired.	Repair the circuits that originate from or drop at the specified node, with the new MAC address.
WID-2166	The node cannot be inserted into the domain because it is not initialized.	Initialize the node and proceed.
WID-2167	You have insufficient security privileges to perform this action.	You do not have the privilege to perform this action.
WID-2168	The following warnings surfaced while loading {0}. {1}	CTC encountered warnings while loading the alarm profile import file.
WID-2169	One or more of the profiles selected do not exist on one or more of the nodes selected.	The profile selected does not exist on the node. Select another profile.
WID-2170	The profile list on node {0} is full. Please delete one or more profiles if you wish to add the profile. {1}	The number of profile that can exist on a node has reached the limit. To add a profile, delete any of the existing profiles.
WID-2171	You have been logged out. Click OK to exit CTC.	Refer to the warning message text.

Table 4-1 Error Messages (continued)

Error Warning ID	Error Warning Message	Description
WID-2172	The CTC CORBA (IIOP) listener port setting of {0} will be applied on the next CTC restart.	The Internet Inter-ORB Protocol (IIOP) listener port setting for the CTC Common Object Request Broker Architecture (CORBA) will be applied on the next CTC restart.
EID-2173	The port is unavailable. The desired CTC CORBA ({0}) listener port, {1}, is already in use or you do not have permission to listen on it. Please select an alternate port.	Select an alternate port, as the current port is either in use or you do not have enough permission on it.
EID-2174	An invalid number was entered. Please check it and try again.	You entered an invalid firewall port number. Try again.
WID-2175	An extension byte mismatch occurred. {0}	There is a mismatch with the extension byte.
WID-2176	Not all spans have the same OSPF area ID. This will cause problems with protection switching. To determine the OSPF area for a given span, click on the span and the OSPF area will be displayed in the pane to the left of the network map.	Refer to the warning message text.
WID-2178	Only one edit pane can be opened at a time. The existing pane will be displayed.	Refer to the warning message text.
WID-2179	No update is available because the circuit has been deleted.	Refer to the warning message text.
EID-2180	The CTC initialization failed during step {0}.	CTC initialization has failed in the specified step.
EID-2181	This link cannot be included because it originates from the destination.	You must not include this link as it originates from destination of a circuit. It is against the path selection algorithm.
EID-2182	The value of {0} is invalid.	The value of the specified item is invalid.
EID-2183	The circuit roll failed. Bridge and roll is not supported on VCAT circuits.	Refer to the error message text.
EID-2184	Spanning Tree Protocol cannot be enabled on some ports because the ports have been assigned an incompatible list of VLANs. You can view the VLAN/Spanning Tree table or reassign the Ethernet port VLANs.	Refer to the error message text.
EID-2185	The VLANs on some ports cannot be assigned because they are incompatible with the Spanning Tree Protocol. You can view the VLAN/Spanning Tree table or reassign the VLANs.	Refer to the error message text.
EID-2186	The software download failed on node {0}.	The software could not be downloaded onto the specified node.
EID-2187	The ring name cannot exceed {0} characters. Please try again.	You must shorten the length of the ring name.

Table 4-1 **Error Messages (continued)**

Error Warning ID	Error Warning Message	Description
EID-2188	The nodes in this ring do not support alphanumeric IDs. Please use a ring ID between {0} and {1}.	The ring ID should not contain alphanumeric characters, and must be in the specified range.
EID-2189	The TL1 keyword "all" cannot be used as the ring name. Please provide another name.	Refer to the error message text.
EID-2190	Adding this span will cause the ring to contain more nodes than allowed.	You have reached the maximum number of nodes allowed.
EID-2191	The ring name must not be empty.	You must supply a ring name.
EID-2192	A valid route cannot be found for the circuit creation request.	CTC could not complete the circuit creation request either because there are no physical links, or the bandwidth of the available links are already reserved.
EID-2193	A valid route cannot be found for the circuit drop creation request.	Refer to the error message text.
EID-2194	A valid route cannot be found for the roll creation request.	Refer to the error message text.
EID-2195	The circuit VLAN list cannot be mapped to one spanning tree. You can view the VLAN/Spanning Tree table or reassign VLANs.	Refer to the error message text.
EID-2196	CTC cannot be relaunched. {0}	There is an error relaunching CTC.
EID-2197	A CORBA failure occurred. CTC cannot proceed.	There was a CORBA failure, and the task cannot proceed. Verify the Java version.
EID-2198	CTC is unable to switch to the {0} view.	CTC is unable to switch to the specified view.
EID-2199	Login failed on {0} {1}	The login failed on the specified tasks.
EID-2200	CTC has detected a jar file deletion. The jar file was used to manage one or more nodes. This CTC session will not be able to manage those nodes and they will appear gray on the network map. It is recommended that you exit this CTC session and start a new one.	Refer to the error message text.
EID-2202	An intra-node DRI circuit must have two sources.	Intranode circuit must have two sources to be a dual ring interconnect (DRI).
EID-2203	No member was selected.	You must select a member.
EID-2204	The number of circuits must be a positive integer.	The number of circuits cannot be zero or negative.
EID-2205	The circuit type must be selected.	You must select a circuit type.
EID-2206	The profile cannot be autoselected. Please select profile(s) to store and try again.	Refer to the error message text.
EID-2207	You cannot add this span. Either the ring name is too long (that is, ring name length is greater than {0}) or the endpoints do not support alphanumeric IDs.	Reduce the length of the ring name, or remove the alphanumeric characters from the end points.

Table 4-1 Error Messages (continued)

Error Warning ID	Error Warning Message	Description
EID-2208	This is an invalid or unsupported JRE.	The version of Java Runtime Environment (JRE) is either invalid or unsupported.
EID-2209	The user name must be at least {0} characters long.	The user name must be at least of the specified character length.
EID-2210	No package name was selected.	You must select a package name.
EID-2211	No node was selected for upgrade.	You must select a node for the upgrade.
EID-2212	A protected line is not provisionable.	The protected line cannot be provisioned. Choose another line.
WID-2213	The current type or state of some drops does not allow the new circuit state of {0} to be applied to them indirectly.	The circuit state, specified by {0} cannot be applied to the selected drops.
EID-2214	The node is disconnected. Please wait until the node reconnects.	Refer to the error message text.
EID-2215	An error occurred while leaving the {0} page.	There was an error while leaving the specified page.
EID-2216	An error occurred while entering the {0} page.	There was an error while entering the specified page.
EID-2217	Some conditions could not be retrieved from the network view	Refer to the error message text.
EID-2218	The bandwidth must be between {0} and {1} percent.	The bandwidth must be within the specified parameters.
EID-2219	The protection operation failed. An XC loopback was applied on the cross-connection.	As the protection operation failed, a cross-connect (XC) loopback will be applied on cross-connection.
EID-2220	The tunnel status is PARTIAL. CTC is not able to change it. Please try again later.	Refer to the error message text.
EID-2221	A valid route cannot be found for the unprotected to {0} upgrade request.	Refer to the error message text.
EID-2222	One or more of the following nodes are currently part of a four-fiber {0}. Only a single four-fiber {0} is supported per node. {1}	The nodes, specified by {1}, are already part of a 4-fiber BLSR/MS-SPRing type (specified by {0}).
EID-2223	Only one circuit can be upgraded at a time.	Refer to the error message text.
EID-2224	This link may not be included because it terminates on the source.	Refer to the error message text.
EID-2225	A valid signal could not be detected while trying to complete the roll. {0}	Roll can be completed only when a valid signal is detected. If not, the roll completion may result in an error.
EID-2226	The circuit roll failed. {0}	Refer to the error message text.
EID-2320	This VCAT circuit does not support deletion of its member circuits.	You can not delete a circuit that is a member of VCAT circuit.

Table 4-1 **Error Messages (continued)**

Error Warning ID	Error Warning Message	Description
EID-2321	An error occurred while deleting member circuits. {0}	Refer to the error message text.
WID-2322	Not all cross-connects from selected circuits could be merged into the current circuit. They might appear as partial circuits.	Refer to the warning message text.
EID-2323	The circuit roll failed. Bridge and roll is not supported on monitor circuits.	A monitor circuit does not support Bridge and Roll.
EID-2324	An error occurred during the circuit upgrade. {0}	Refer to the error message text.
EID-2325	You have failed {0} times to unlock this session. CTC will exit after you click OK or close this dialog box.	The maximum amount of attempts to unlock this session has been reached.
WID-2326	Currently, CTC does not support bridge and roll on circuits that are entirely created by TL1. To continue with bridge and roll in CTC, the selected circuits must be upgraded. Is it OK to upgrade the selected circuits and continue the bridge and roll operation?	Refer to the warning message text.
WID-2327	Currently, CTC does not support bridge and roll on circuits that are partially created by TL1. To continue with bridge and roll in CTC, the selected circuits must be upgraded. Is it OK to upgrade the selected circuits and continue the bridge and roll operation?	Refer to the warning message text.
EID-2328	An error occurred during the circuit reconfiguration. {0}	The attempt to reconfigure the specified circuit has failed.
EID-2329	{0} of {1} circuits could not be successfully created.	A few circuits could not be created.
EID-2330	An error occurred during circuit verification. The selected {0} is invalid! {1}	The selected item, specified by {0}, is invalid as per the details, specified in {1}.
EID-2331	Deleting {0} might be service affecting.	Deleting the item can affect the service of CTC.
EID-2332	A validation error occurred in row {0}. {1} hold-off timer for {2} must be between {3}-10,000 ms, in steps of 100 ms.	Refer to the error message text.
EID-3001	An Ethernet RMON threshold with the same parameters already exists. Please change one or more of the parameters and try again.	Change a few parameters in an Ethernet remote monitoring (RMON) threshold and try again.
EID-3002	An error occurred while retrieving defaults from the node: {0}	There was an error while retrieving the defaults from the specified node.
EID-3003	The file {0} cannot be loaded.	CTC cannot load the specified file.
EID-3004	Properties cannot be loaded from the node.	Refer to the error message text.
EID-3005	NE update properties cannot be saved to the file {0}.	CTC cannot save the network element (NE) update values to the specified file.
EID-3006	NE update properties cannot be loaded from the node.	Refer to the error message text.

Table 4-1 Error Messages (continued)

Error Warning ID	Error Warning Message	Description
EID-3007	An error occurred while provisioning the {0}.	There was a provisioning error for the specified item.
EID-3008	This is not a valid card.	You cannot perform DWDM automatic node setup (ANS) from the Card view. Please navigate to the Node view and try again.
EID-3009	No {0} was selected.	Select the specified item, for example, VLAN, port, slot, etc.
EID-3010	A bidirectional optical link could not be created.	Refer to the error message text.
EID-3016	The subnet address is invalid.	Refer to the error message text.
EID-3017	The subnet address already exists.	Refer to the error message text.
EID-3019	The internal subnet address is incomplete.	Enter the complete internal subnet address.
EID-3020	The subnet address cannot be the same for both TSC cards. The requested action is not allowed.	A node's internal subnet must be different from one another as each TSC is on separate ethernet buses, isolated by broadcast domains.
EID-3021	An error occurred while retrieving the diagnostics: {0}	Refer to the error message text.
EID-3022	The requested action is not allowed.	The requested action is not allowed.
EID-3023	The low order cross-connect mode could not be retrieved.	Refer to the error message text.
EID-3024	The {0} cross-connect mode could not be switched. Please verify that the type and/or number of circuits provisioned does not exceed the criterion for switching modes.	CTC cannot switch the cross-connect mode for the specified item, as the type or the number of circuits does not match with the criterion for switching modes.
EID-3025	An error occurred while retrieving thresholds.	There was an error retrieving the thresholds.
EID-3026	The send DoNotUse attribute cannot be modified.	You cannot modify the Send DoNotUse field.
EID-3027	The SyncMsg attribute cannot be modified.	You cannot modify the SyncMsg field.
EID-3028	The port type cannot be changed.	You cannot change the port type.
EID-3029	Unable to switch to the byte because an overhead change is present on this byte of the port.	Refer to the error message text.
EID-3031	An error occurred while hard-resetting the card.	There was an error while resetting card hardware.
EID-3032	An error occurred while resetting the card.	There was an error while resetting the card.
EID-3033	The lamp test is not supported on this shelf.	Refer to the error message text.
EID-3035	The cross-connect diagnostics cannot be performed	Refer to the error message text.
EID-3036	The cross-connect diagnostics test is not supported on this shelf.	The cross-connect diagnostics test is not supported on this shelf.
EID-3039	An error occurred while changing the card type.	There was an error while changing the card.
EID-3040	The card type is invalid.	The selected card type is invalid.

Table 4-1 Error Messages (continued)

Error Warning ID	Error Warning Message	Description
EID-3041	An error occurred while applying changes.	CTC is unable to create a protection group. Check if the protect port supports circuits, a timing reference, SONET SDCC, orderwire, or a test access point.
EID-3042	The flow control low value must be less than the flow control high value for all ports in the card.	Refer to the error message text.
EID-3046	The flow control watermark value must be between {0} and {1}, inclusive.	The flow control watermark value must be between the two specified values.
EID-3047	The file {0} could not be read. Please verify the name and try again.	Refer to the error message text.
EID-3048	There is no Cisco IOS startup configuration file available to download.	CTC could not find the configuration file for IOS startup.
EID-3049	The download cannot be done at this time because an update in progress.	Refer to the error message text.
EID-3050	An error occurred while trying to save the file to your local file system.	Check whether the file already exists and cannot be over written, or there is a space constraint in the file system.
EID-3051	The configuration file has a maximum size of {0} bytes.	The size of the configuration file should not exceed the specified number of bytes.
EID-3052	An error occurred while saving the configuration file to the TCC2/TCC2P.	Refer to the error message text.
EID-3053	The value of {0} must be between {1} and {2}.	The value of the item must be between the specified values.
EID-3054	The provisioned input/output ports cannot be removed or another user is updating the card. Please try to remove these ports later.	Another user may be updating the card. You can try again later.
EID-3055	The soak maintenance pane cannot be created.	Refer to the error message text.
EID-3056	Defaults cannot be saved to the file {0}.	CTC cannot save the defaults to the specified file.
EID-3057	Default properties cannot be loaded from the node.	Refer to the error message text.
EID-3058	The file {0} does not exist.	Refer to the error message text.
EID-3059	An error occurred while refreshing.	There was an error while refreshing.
EID-3060	The ALS recovery pulse interval must be between {0} seconds and {1} seconds.	The automatic laser shutdown (ALS) Recovery Interval must be between the specified range of seconds.
EID-3061	The ALS recovery pulse duration must be between {0} seconds and {1} seconds.	The automatic laser shutdown (ALS) Recovery Duration must be between the specified range of seconds.
EID-3062	An error occurred while setting values in the table.	Refer to the error message text.
EID-3064	This is not a G1000 card.	This card is not a G1000-4 card.

Table 4-1 Error Messages (continued)

Error Warning ID	Error Warning Message	Description
EID-3065	An error occurred while attempting to create this RMON threshold: {0}	You must wait some time before you try again.
EID-3066	The sample period must be between 10 and {0}.	Refer to the error message text.
EID-3067	The rising threshold must be between 1 and {0}.	This is an invalid rising threshold entry. The valid range is from 1 to the specified value.
EID-3068	The falling threshold must be between 1 and {0}.	This is an invalid falling threshold entry. The valid range is from 1 to the specified value.
EID-3069	The rising threshold must be greater than or equal to the falling threshold.	Refer to the error message text.
EID-3070	Error in data for ports {0} Exactly one VLAN must be marked untagged for each port. These changes will not be applied.	CTC encountered data error for the specified ports. Only one VLAN should be marked untagged for each port.
EID-3071	An error occurred while retrieving the learned address list.	Unable to retrieve the learned MAC address from the NE.
EID-3072	An error occurred while clearing the learned address.	Failure attempting to clear the learned MAC address from a specific card or Ether group.
EID-3073	An error occurred while clearing the selected rows.	Failure attempting to clear the learned MAC address from a specific card or Ether group.
EID-3074	An error occurred while clearing the learned address list by {0}.	Error encountered trying to clear the learned MAC address from either a VLAN or a port.
EID-3075	At least one row in the parameter column must be selected.	Refer to the error message text.
EID-3076	CTC lost its connection with this node. The NE Setup Wizard will exit.	Refer to the error message text.
EID-3077	No optical link was selected.	Refer to the error message text.
EID-3078	An optical link could not be created.	Refer to the error message text.
EID-3079	Defaults cannot be applied to the node. {0}	CTC cannot apply the defaults to the specified node.
EID-3080	CTC cannot navigate to the target tab. {0}	CTC cannot go to the specified target tab.
EID-3081	The port type cannot be changed.	Refer to the error message text.
EID-3082	The {0} extension byte cannot be changed.	You cannot modify the specified extension byte.
EID-3084	An error occurred while retrieving laser parameters for {0}.	There is no card, or there was an internal communications error when attempting to get the laser parameters for the card.
EID-3085	No OSC Terminations were selected	Select an OSC termination and proceed.
EID-3086	One or more Osc terminations could not be created.	Refer to the error message text.
EID-3087	The OSC termination could not be edited.	Refer to the error message text.

Table 4-1 **Error Messages (continued)**

Error Warning ID	Error Warning Message	Description
EID-3088	No {0} card is present to switch.	No card of the specified type is available to switch.
EID-3089	The {0} state cannot be used or changed when the {1} has failed or is missing.	You cannot use or change the specified state when the card is failed or missing.
EID-3090	The operation cannot be performed because the {0} is {1}LOCKED_ON/LOCKED_OUT.	You cannot perform operation.
EID-3091	The operation cannot be performed because the protect card is active.	Refer to the error message text.
EID-3092	The requested action cannot be applied because the service state is invalid.	Select another service state and proceed.
EID-3093	The operation cannot be performed because the duplex pair is {0}locked.	Refer to the error message text.
EID-3094	The operation cannot be performed because no cross-connect redundancy is available.	You cannot perform the requested operation on the cross connect card without having a backup cross connect card.
EID-3095	The deletion failed because the circuit is in use	Refer to the error message text.
WID-3096	An internal communication error was encountered while retrieving laser parameters. This can happen when equipment is not present or when equipment is resetting. Check the equipment state and try to refresh the values again.	Refer to the warning message text.
EID-3097	The ring termination is in use.	The ring termination you are trying to access is in use. Try after sometime.
EID-3098	No ring terminations were selected.	Select one of the ring terminations.
EID-3099	The entered key does not match the existing authentication key.	Check the authentication key and reenter.
EID-3100	An error occurred during authentication.	There was an error in authentication. Verify that the key does not exceed the character limit.
EID-3101	The DCC metric must be between 1 and 65535.	The DCC metric should be in the range of 1 to 65535.
EID-3102	The DCC metric is invalid.	There was an invalid DCC metric.
EID-3103	The IP address {0} is invalid}.	The IP address is invalid.
EID-3104	The router priority must be between 0 and 255.	The router priority should be in the range of 0 to 255.
EID-3105	The router priority is invalid.	The router priority is invalid.
EID-3106	The hello interval must be between 1 and 65535.	The hello interval should be in the range of 1 to 65535.
EID-3107	The hello interval is invalid.	The hello interval is invalid.
EID-3109	The dead interval must be between 1 and 2147483647.	The dead interval value must be between 1 and 2147483647.
EID-3110	The dead interval must be larger than the hello interval.	Refer to the error message text.

Table 4-1 Error Messages (continued)

Error Warning ID	Error Warning Message	Description
EID-3111	The LAN transmit delay must be between 1 and 3600 seconds.	The LAN transit delay should be in the range of 1 to 3600 seconds.
EID-3112	The transmit delay is invalid.	The transmit delay is invalid.
EID-3113	The retransmit interval must be between 1 and 3600 seconds.	The retransmit interval should be in the range of 1 to 3600 seconds.
EID-3114	The retransmit interval is invalid.	The retransmit interval is invalid.
EID-3115	The LAN metric must be between 1 and 65535.	The LAN metric should be in the range of 1 to 65535.
EID-3116	The LAN metric is invalid.	The LAN metric is invalid.
EID-3117	If OSPF is active on the LAN, no DCC area IDs may be 0.0.0.0. Please change all DCC area IDs to non-0.0.0.0 values before enabling OSPF on the LAN.	Refer to the error message text.
EID-3118	If OSPF is active on the LAN, the LAN area ID cannot be the same as the DCC area ID.	LAN must be part of a different OSPF area other than the DCC network.
EID-3119	An error occurred during validation.	CTC was unable to validate the values entered by the user. This error message is common to several different provisioning tabs within CTC (examples include the SNMP provisioning tab, the General > Network provisioning tab, the Security > Configuration provisioning tab, etc.).
EID-3120	No object of type {0} was selected for deletion.	Choose an object of the specified type to delete.
EID-3121	An error occurred while deleting {0}.	There is an error deleting the item.
EID-3122	No object of type {0} was selected to edit.	Choose an object of the specified type to edit.
EID-3123	An error occurred while editing {0}.	There was an error editing the item.
EID-3124	The {0} termination is in use. Delete the associated OSPF range table entry and try again.	Refer to the error message text.
EID-3125	No {0} terminations were selected.	No specified terminations are selected.
EID-3126	The {0} termination could not be edited.	CTC could not edit the specified termination.
EID-3127	Orderwire cannot be provisioned because the E2 byte is in use by {0}.	Refer to the error message text.
EID-3128	The authentication key cannot exceed {0} characters.	The authentication key cannot exceed the specified number of characters.
EID-3129	The authentication keys do not match!	Refer to the error message text.
EID-3130	An error occurred while creating the OSPF area virtual link.	CTC encountered an error while creating the area virtual link.
EID-3131	An error occurred while creating the OSPF virtual link.	CTC encountered an error creating the virtual link.

Table 4-1 **Error Messages (continued)**

Error Warning ID	Error Warning Message	Description
EID-3132	An error occurred while setting the OSPF area range: {0}, {1}, false.	CTC encountered an error while setting the area range for the specified values.
EID-3133	The maximum number of OSPF area ranges has been exceeded.	OSPF area ranges exceeded the maximum number.
EID-3134	The area ID is invalid. Use the DCC OSPF area ID, LAN port area ID, or 0.0.0.0.	Refer to the error message text.
EID-3135	The mask is invalid.	Refer to the error message text.
EID-3136	The range address is invalid.	The range address is invalid. Try again.
EID-3137	Your request has been denied because the timing source information was updated while your changes were still pending. Please retry.	Refer to the error message text.
EID-3138	The clock source for switching is invalid.	You have selected an invalid clock source. Choose another clock.
EID-3139	A switch cannot be made to a reference of inferior quality.	Refer to the error message text.
EID-3140	A higher priority switch is already active.	You cannot switch the timing source manually when a higher priority switch is already active.
EID-3141	An attempt was made to access a bad reference.	Refer to the error message text.
EID-3142	No switch is active.	None of the switches are active.
EID-3143	An error occurred while creating the static route entry.	CTC encountered an error while a creating static route entry.
EID-3144	The maximum number of static routes has been exceeded.	The number of static routes has exceeded its limit.
EID-3145	The RIP metric must be between 1 and 15.	The Routing Information Protocol (RIP) metric should be in the range of 1 to 15.
EID-3146	The RIP metric is invalid.	Refer to the error message text.
EID-3147	An error occurred while creating the summary address.	There was an error while creating the summary address.
EID-3148	No Layer 2 domain has been provisioned.	You must provision any one of the layer 2 domain.
EID-3149	The MAC addresses could not be retrieved.	Refer to the error message text.
EID-3150	The target file {0} is not a normal file.	The specified target file is not a normal file.
EID-3151	The target file {0} is not writable.	The target file is not writeable. Specify another file.
EID-3152	An error occurred while creating the protection group.	CTC encountered an error creating Protection Group.
EID-3153	The card cannot be deleted because it is in use.	Refer to the error message text.
EID-3154	An error occurred while provisioning the card: CTC cannot {0} the card.	CTC cannot perform the task on the card.

Table 4-1 Error Messages (continued)

Error Warning ID	Error Warning Message	Description
EID-3155	An error occurred while building the menu.	CTC encountered an error building the menu.
EID-3156	An error occurred while building the menu. Cards were not found for the {0} group.	CTC encountered an error while building the menu, as cards could not be found for the specified group).
EID-3157	The selected model could not be set because of an unexpected model class: {0}.	CTC encountered an unexpected model class while trying to complete the task.
EID-3158	Probable causes: - Unable to switch, because a similar or higher priority condition exists on a peer or far-end card. - A loopback is present on the working port.	Refer to the error message text.
EID-3159 ¹	An error occurred while applying the operation.	CTC encountered an error while applying this operation.
EID-3160	An error occurred while provisioning the {0}.	CTC encountered the specified error.
EID-3161	An error occurred while upgrading the ring.	An error was encountered while attempting to upgrade the BLSR. Refer to the details portion of the error dialog box for more information.
EID-3162	This protection operation cannot be set because the protection operation on the other side has been changed but not yet applied.	Refer to the error message text.
EID-3163	The data in row {0} cannot be validated.	CTC cannot validate the data for the specified row.
EID-3164	The new node ID ({0}) for ring ID {1} duplicates the ID of node {2}.	The new specified node ID for the specified ring ID is the same as another node ID.
EID-3165	The ring ID provided is already in use. Ring IDs must be unique.	Refer to the error message text.
EID-3166	An error occurred while refreshing the {0} table.	CTC encountered an error while refreshing the specified table.
EID-3167	The slot is already in use.	Refer to the error message text.
EID-3168	An error occurred while provisioning.	An error was encountered while attempting the specified provisioning operation. Refer to the details portion of the error dialog box for more information.
EID-3169	An error occurred while adding the card.	CTC encountered an error while adding the card.
EID-3170	You cannot delete this card: {0}.	Refer to the error message text.
EID-3171	An error occurred while creating the trap destination.	CTC encountered an error creating the trap destination.
EID-3172	No RMON thresholds were selected.	Select an RMON threshold.
EID-3173	The contact "{0}" cannot exceed {1} characters.	The specified contact exceeds the specified character limit.

Table 4-1 Error Messages (continued)

Error Warning ID	Error Warning Message	Description
EID-3174	The description "{0}" cannot exceed {1} characters.	The specified location exceeds the specified character limit.
EID-3175	The operator identifier "{0}" cannot exceed {1} characters.	The specified operator identifier exceeds the specified character limit.
EID-3176	The operator specific information "{0}" cannot exceed {1} characters.	The specified operator specific information exceeds the specified character limit.
EID-3177	The node name cannot be empty.	The specified name is empty.
EID-3178	The node name "{0}" cannot exceed {1} characters.	The specified name exceeds the specified character limit.
EID-3179	The protect card is in use.	Refer to the error message text.
EID-3180	The 1+1 protection group does not exist.	Create a 1+1 protection group.
EID-3181	The Y-cable protection group does not exist.	Refer to the error message text.
EID-3182	The topology element is in use and cannot be deleted as requested.	You cannot delete the topology element which is in use.
EID-3183	An error occurred while deleting the protection group.	CTC encountered an error while deleting the protection group.
EID-3184	No {0} was selected.	You must select an item before completing this task.
EID-3185	This ring has an active protection switch operation and cannot be deleted at this time.	Refer to the error message text.
EID-3186	The node is busy: {0} is {1} and cannot be deleted as requested.	The request cannot be completed.
EID-3187	An error occurred while deleting the trap destination.	CTC encountered an error deleting the trap destination.
EID-3188	An error occurred during authentication. The password entered is invalid.	The password you entered is invalid. Enter the password again.
EID-3189	The sum of the {0} must be between {1} and {2}.	Refer to the error message text.
EID-3214	The number of high order circuits for the line could not be retrieved.	The number of High Orders (STS/STM) for the line is not available.
EID-3215	An error occurred while refreshing.	Used frequently in pane classes to indicate a general error condition when trying to refresh from the model.
EID-3216	The proxy port is invalid.	Refer to the error message text.
EID-3217	The statistics could not be refreshed.	CTC could not refresh statistics values.
EID-3218	The automatic node setup could not be launched.	Refer to the error message text.
EID-3219	The automatic node setup information could not be refreshed.	Failure trying to retrieve automatic node setup information.
EID-3220	An error occurred while refreshing row {0}.	Error refreshing the specified row.
EID-3222	The statistics could not be cleared.	Refer to the error message text.

Table 4-1 Error Messages (continued)

Error Warning ID	Error Warning Message	Description
EID-3225	An error occurred while refreshing the pane.	Used frequently in pane classes to indicate a general error condition when trying to refresh from the model.
EID-3226	The {0} termination(s) could not be deleted. {1}	Refer to the error message text.
EID-3227	A baseline could not be recorded. Performance metrics will remain unchanged.	CTC failed to set the baseline values while provisioning NE. Previous values remain unchanged.
EID-3228	The {0} termination(s) could not be created. {1}	Refer to the error message text.
EID-3229	RIP is active on the LAN. Please disable RIP before enabling OSPF.	Turn off the Routing Information Protocol (RIP) on the LAN, before enabling OSPF.
EID-3230	OSPF is active on the LAN. Please disable OSPF before enabling RIP.	Turn off the OSPF on the LAN before enabling RIP.
EID-3231	An error occurred while setting the OPR.	An error was encountered while attempting to provision the optical power received (OPR).
WID-3232	The port state cannot be indirectly transitioned because the port is still providing services. If the port state should be changed, edit it directly through port provisioning.	Edit the port state while provisioning the port.
EID-3233	The current loopback provisioning does not allow this state transition.	Refer to the error message text.
EID-3234	The current synchronization provisioning does not allow this state transition.	You cannot transition the port state to the target date while in the current synchronization state.
EID-3235	The requested state transition cannot be performed on this software version.	Refer to the error message text.
EID-3236	The database restore failed. {0}	CTC failed to restore the specified database.
EID-3237	The database backup failed. {0}	CTC failed to backup the specified database.
EID-3238	The send PDIP setting on {0} is inconsistent with the setting on the control node {1}.	The send payload defect indicator path (PDI-P) setting on the specified item should be consistent with that of the specified control node.
EID-3239	The overhead termination is invalid	Refer to the error message text.
EID-3240	The maximum number of overhead terminations has been exceeded.	Overhead terminations have exceeded the limit.
EID-3241	The {0} termination port is in use.	The specified termination port is in use. Select another port.

Table 4-1 Error Messages (continued)

Error Warning ID	Error Warning Message	Description
EID-3242	An {1} exists on the selected ports. Therefore, you must create the {0}s one by one.	The specified DCC already exists on the selected port. You can create a DCC of another type.
WID-3243	The port you have chosen as an {0} endpoint already supports an {1}. The port cannot support both DCCs. After the {0} is created, verify that no EOC alarms are present and then delete the {1} to complete the downgrade.	The same port can not be used by multiple DCCs.
EID-3244	An {0} exists on the selected ports. Therefore, you must create the {1}s one by one.	The specified DCC already exists on the selected port. You can create a DCC of another type.
WID-3245	The port you have chosen as an {1} endpoint already supports an {0}. The port cannot support both DCCs. After the {1} is created, verify that no EOC alarms are present and then delete the {0} to complete the upgrade.	The port selected as a DCC endpoint already supports another DCC. Refer to the warning message text.
EID-3246	The wizard was not able to validate the data. {0}	CTC encountered an error.
EID-3247	An ordering error occurred. The absolute value should be {0}.	The absolute value entered was wrong.
EID-3248	The value for the parameter {0} is invalid.	CTC changed the incorrect parameter.
EID-3249	The voltage increment value is invalid.	Refer to the error message text.
EID-3250	The power monitor range is invalid.	Refer to the error message text.
EID-3251	The requested action could not be completed. {0}	CTC could not complete the specified action.
EID-3252	No download has been initiated from this CTC session.	Refer to the error message text.
EID-3253	The reboot operation failed. {0}	Refer to the error message text.
EID-3254	An error occurred during validation. {0}	The Cisco Transport Controller (CTC) was unable to validate the values entered by the user, specified by {0}. This error message is common to several different provisioning tabs within the CTC.
EID-3255	You cannot change the timing configuration because a Manual/Force operation is in effect.	Refer to the error message text.
WID-3256	The timing reference(s) could not be assigned because one or more of the timing reference(s): - is already used and/or - has been selected twice and/or - is attempting to use the same slot twice. Please verify the settings.	Refer to the warning message text.
EID-3257	Duplicate DCC numbers are not permitted. {0}.	CTC detected more than one occurrence of the a DCC number. Remove one of them.
EID-3258	A software error occurred while attempting to download the file. Please try again later.	Refer to the error message text.

Table 4-1 Error Messages (continued)

Error Warning ID	Error Warning Message	Description
EID-3259	An error occurred while creating the FC-MR threshold.	You must create a Fibre Channel Multirate (FC_MR) card threshold.
EID-3260	An error occurred while provisioning the internal subnet: {0}	The specified internal subnet could not be provisioned.
EID-3261	The port rate provisioning cannot be changed while circuits exist on this port.	Refer to the error message text.
EID-3262	The port provisioning cannot be changed when the port status is {0}.	You must provision the ports only when the port is Out of Service.
WID-3263	You are using Java version {0}. CTC should run with Java version {1}. It can be obtained from the installation CD or http://java.sun.com/j2se/	CTC is being launched with the wrong version of the JRE {0}. This version of CTC requires a particular version of the JRE {1}. The CTC and browser must be closed and restarted to allow the correct Java version to be loaded.
EID-3265	An error occurred while modifying the protection group.	Protection Group could not be modified.
EID-3266	Conditions could not be retrieved from the shelf or card view.	Refer to the error message text.
WID-3267	The XTC protection group cannot be modified.	Refer to the warning message text.
WID-3268	The filter entry is invalid. {0}	The specified entry is invalid.
WID-3269	The {0} operation was successfully initiated for {1} but its completion status could not be obtained from the node. When the node is accessible, check its software version to verify if the {0} succeeded.	Refer to the error message text.
WID-3270	The file {0} does not exist.	The specified file does not exist.
WID-3271	The value entered must be greater than {0}.	The value entered must be greater than the specified value.
WID-3272	An entry is required.	An entry is required to complete this task.
WID-3273	{0} already exists in the list.	The specified item already exists in the list.
WID-3274	A software upgrade is in progress. Network configuration changes that result in a node reboot cannot take place during a software upgrade. Please try again after the software upgrade is done.	Refer to the warning message text.
WID-3275	Ensure that the remote interface ID and the local interface ID on the two sides match. (The local interface ID on this node should equal the remote interface ID on the neighbor node and vice-versa).	Refer to the warning message text.
WID-3276	Both {0} and {1} exist on the same selected port. {2}	The specified port has both SDCC and LDCC.
WID-3277	The description cannot exceed {0} characters. Your input will be truncated.	The input exceeds the character limit. The value will be truncated to the maximum chapter limit.
WID-3279	This card has been deleted. CTC will return to the shelf view.	CTC returns to node view.

Table 4-1 Error Messages (continued)

Error Warning ID	Error Warning Message	Description
WID-3280	ALS will not engage until both the protected trunk ports detect LOS.	Refer to the warning message text.
WID-3282	Performing a software upgrade while TSC 5 is active could result in a service disruption. It is recommended that you make TSC 10 the active TSC by performing a soft reset of TSC 5. The following ONS 15600s are currently unsafe to upgrade...	Refer to the warning message text.
WID-3283	Before activating a new version, ensure that you have a database backup from the current version.	Refer to the warning message text.
WID-3284	Reverting to an older version.	CTC is being reverted to an older version of application.
WID-3285	Applying FORCE or LOCKOUT operations might result in traffic loss.	Refer to the warning message text.
WID-3286	The ring status is INCOMPLETE. CTC cannot determine if there are existing protection operations or switches in other parts of the ring. Applying a protection operation at this time could cause a traffic outage. Please confirm that no other protection operations or switches exist before continuing.	Refer to the warning message text.
WID-3287	There is a protection operation or protection switch present on the ring. Applying this protection operation now will probably cause a traffic outage.	Refer to the warning message text.
WID-3288	The status of this ring is INCOMPLETE. CTC will not be able to apply this change to all of the nodes in the {0}.	Change the ring status to apply the change to all nodes in the ring type.
EID-3290	The specified provisionable patchcord(s) could not be deleted.	Refer to the error message text.
EID-3291	The revertive behavior cannot be changed because a protection switch is active.	Protection switch should not be active to change the revertive behavior.
EID-3292	An error occurred while resetting the shelf.	CTC encountered an error while resetting the node.
EID-3293	No such provisionable patchcords exists.	You are attempting to delete a provisionable patchcord that does not exist. This happens when multiple instances of CTC are running and attempting to delete the same provisionable patchcord concurrently.
EID-3294	No RMON thresholds are available for the selected port.	Refer to the error message text.
EID-3295	This card does not support RMON thresholds.	Refer to the error message text.
EID-3296	Buffer-to-buffer credit is only supported for Fibre Channel (FC) and FICON.	Refer to the error message text.
EID-3298	This interfaces does not support ALS auto restart.	Refer to the error message text.
EID-3300	Duplicate OSPF area IDs are not permitted.	OSPF area IDs should be unique.
EID-3301	The LAN metric cannot be zero.	Refer to the error message text.
EID-3302	The standby {0} is not ready.	Standby controller card is not ready.

Table 4-1 Error Messages (continued)

Error Warning ID	Error Warning Message	Description
EID-3303	The DCC area ID and {0} conflict. {1}	DCC Area ID and ring type, specified by {0}, conflict each other due to the details specified by {1}.
EID-3304	The DCC number is out of range.	Enter a DCC number that is within the range
EID-3305	OSPF cannot be active on the LAN interface when the backbone area is set on a DCC interface.	You cannot have the default OSPF area on a DCC while OSPF is enabled on the LAN.
EID-3306	Ethernet circuits must be bidirectional.	Refer to the error message text.
EID-3307	An error occurred while creating a connection object at {0}.	CTC encountered an error at the specified connection while creating the connection.
EID-3308	DWDM links can be used only for optical channel circuits.	Refer to the error message text.
EID-3309	The link was excluded because it was in the wrong direction.	The optical channel (circuit) does not allow the specified link to be included because it is in the wrong optical direction.
EID-3310	The DWDM link does not have wavelengths available.	Refer to the error message text.
EID-3311	The laser is already on.	Refer to the error message text.
EID-3312	The power setpoint cannot be changed. {0} {1}	CTC cannot change the power setpoint. The new setpoint would either make the thresholds inconsistent or set the fail threshold outside the range.
EID-3313	The offset cannot be modified because the service state of the port is IS.	Refer to the error message text.
EID-3314	The requested action is not allowed. The state value is invalid.	Refer to the error message text.
EID-3315	This operation cannot be performed.	CTC is unable to perform operation.
EID-3316	The node side is invalid.	This task was applied to the wrong node side.
EID-3317	The ring name is too long.	Reduce the number of characters in the name.
EID-3318	The ring name is invalid.	The name you entered is illegal.
EID-3319	The wrong line was selected.	Select another line
EID-3320	The optical link could not be deleted.	CTC cannot delete the optical link.
EID-3321	This feature is unsupported by this version of software.	Refer to the error message text.
EID-3322	The equipment is not plugged in.	Plug-in the equipment and proceed.
EID-3323	The APC system is busy.	Automatic Power Control (APC) system is busy.
EID-3324	There is no path to regulate.	There is no circuit path to regulate.
EID-3325	The requested action is not allowed.	Generic DWDM provisioning failure message.
EID-3326	The input was invalid.	The input value is incorrect.

Table 4-1 Error Messages (continued)

Error Warning ID	Error Warning Message	Description
EID-3327	An error occurred while retrieving thresholds.	There was an error retrieving the thresholds. This message is displayed only for the OSCM/OSC-CSM line thresholds.
EID-3328	An error occurred while applying changes to row {0}. The value is out of range.	There was an error applying the changes to the specified row. The value is out of range.
EID-3330	Unable to switch to the byte because an overhead channel is present on this byte of the port.	Refer to the error message text.
EID-3331	An error occurred while applying changes to the row.	Refer to the error message text.
EID-3334	Timing parameters on the protect port cannot be changed.	You cannot change timing parameters on protect port.
EID-3335	The port type cannot be changed because the SDH validation check failed. Check if this port is part of a circuit, protection group, SONET DCC, orderwire, or UNI-C interface.	Refer to the error message text.
EID-3336	An error occurred while reading a control mode value.	The Control Mode must be retrieved.
EID-3337	An error occurred while setting a set point gain value.	The Gain Set Point must be set.
EID-3338	An error occurred while reading a set-point gain value.	The Gain Set Point must be retrieved.
EID-3339	An error occurred while setting a tilt calibration value.	The tilt calibration must be set.
EID-3340	An error occurred while setting expected wavelength.	The expected wavelength must be set.
EID-3341	An error occurred while reading expected wavelength.	The expected wavelength must be retrieved.
EID-3342	An error occurred while reading actual wavelength.	The actual wavelength must be retrieved.
EID-3343	An error occurred while reading actual band.	The actual band must be retrieved.
EID-3344	An error occurred while reading expected band.	The expected band must be retrieved.
EID-3345	An error occurred while setting expected band.	The expected band must be set.
EID-3346	An error occurred while retrieving defaults from the node: {0}.	There was an error retrieving defaults from the specified node.
EID-3347	The file {0} cannot be loaded.	CTC cannot load the specified file.
EID-3348	Properties cannot be loaded from the node.	Refer to the error message text.
EID-3349	NE update properties cannot be saved to a file.	Check your file system for space constraint or any other problem.
EID-3350	NE update properties cannot be loaded from the node.	Refer to the error message text.
EID-3351	The file {0} does not exist.	The specified file does not exist.
EID-3352	An error occurred while setting a value at {0}.	There was an error while setting the value at the specified location.
EID-3353	No such interface is available.	The interface specified is not present in CTC.
EID-3354	The specified endpoint is in use.	Select another endpoint that is not in use.
EID-3355	The specified endpoint is incompatible.	Refer to the error message text.
EID-3357	The connections could not be calculated.	Refer to the error message text.

Table 4-1 Error Messages (continued)

Error Warning ID	Error Warning Message	Description
EID-3358	An optical link model does not exist for the specified interface.	Create an optical linkmodel for the interface, and proceed.
EID-3359	Optical parameters could not be set for the node.	Refer to the error message text.
EID-3360	ANS cannot be performed. Please check {0} parameter value.	Refer to the error message text.
EID-3361	The ring termination is in use. An error occurred while deleting the ring termination.	You cannot delete a ring in use.
EID-3362	An error occurred while deleting the ring termination.	There was an error while deleting ring termination.
EID-3363	No ring terminations were selected.	You must select a ring termination.
EID-3364	An error occurred while creating the ring ID.	There was an error while creating the ring ID.
EID-3365	The OSC termination is in use.	Select another optical service channel (OSC) which is not in use.
EID-3366	The OSC termination could not be deleted.	There was an error deleting the OSC termination.
EID-3370	No optical link was selected.	You must select an optical link.
EID-3371	An error occurred while calculating the automatic optical link list.	Refer to the error message text.
EID-3372	CTC attempted to access an OCHNC connection that has been destroyed.	CTC destroyed an external attempt to access an optical channel network connection.
EID-3375	The expected span loss must be set.	Refer to the error message text.
EID-3376	The measured span loss could not be retrieved.	Refer to the error message text.
EID-3377	The wrong interface was used.	The interface used for the card is wrong.
EID-3378	This is a duplicate origination patchcord identifier.	The provisionable patchcord identifier to the patchcord you are attempting to provision is already in use by another patchcord on the origination node.
EID-3379	This is a duplicate termination patchcord identifier.	The provisionable patchcord identifier to the patchcord you are attempting to provision is already in use by another patchcord on the remote node.
EID-3380	The host cannot be found.	Refer to the error message text.
EID-3381	The maximum frame size must be between {0} and {1} and may be increased in increments of {2}.	The frame size must be in the specified range. It can increment by the specified value.
EID-3382	The number of credits must be between {0} and {1}.	The number of credits must be between the specified values.

Table 4-1 Error Messages (continued)

Error Warning ID	Error Warning Message	Description
EID-3383	The GFP buffers available must be between {0} and {1} and may be increased in increments of {2}.	The GFP buffers must be in the specified range. It can increment by the specified value.
WID-3384	You are about to force the use of Secure Mode for this chassis. You will not be able to undo this operation. Is it OK to continue?	Refer to the warning message text.
EID-3385	{0}. Delete the circuits and try again.	Refer to the error message text.
EID-3386	The transponder mode could not be provisioned: {0}	The specified transponder mode cannot be provisioned.
EID-3387	You must change port(s) {0} to an out-of-service state before changing card parameters. Click "Reset" to revert the changes.	All the card ports should be changed to out-of-service before changing the parameters.
EID-3388	The card mode cannot be changed because the card has circuits.	Refer to the error message text.
EID-3389	An error occurred while changing the card mode.	Refer to the error message text.
EID-3390	The port is in use.	Refer to the error message text.
EID-3391	The port rate cannot be changed because the port has been deleted.	You cannot change the port rate of a card that has been deleted.
WID-3392	The timing reference(s) could not be assigned because with external timing, only a single protected, or two unprotected timing references per BITS Out can be selected. Please use the "Reset" button and verify the settings.	Refer to the warning message text.
WID-3393	The timing reference(s) could not be assigned because with line or mixed timing, only a single unprotected timing reference per BITS Out can be selected. Please use the "Reset" button and verify the settings.	Refer to the warning message text.
EID-3394	An error occurred while refreshing the power monitoring values.	Refer to the error message text.
EID-3395	The configuration is invalid. {0}	CTC encountered an error in IP address, net mask length, or default router, or a restricted IIOP port was selected.
EID-3396	The configuration is invalid. The standby controller card is not a TCC2P card.	The standby controller card should be a TCC2P card.
EID-3397	The file {0} is the wrong version.	The specified file is of wrong version.
EID-3398	The PPM cannot be deleted.	Refer to the error message text.
EID-3399	The PPM cannot be deleted because it has port(s) in use.	Remove the ports connected to the Pluggable Port Module before it can be deleted.
EID-3400	Unable to switch. A force to the primary facility is not allowed.	Refer to the error message text.
EID-3401	{0} cannot be provisioned for the port while {1} is enabled.	The relationship between parameters {0} and {1} are such that enabling either one, prevents the provisioning of the other.

Table 4-1 Error Messages (continued)

Error Warning ID	Error Warning Message	Description
EID-3402	The switch request could not be completed. The {0} card is not present or is not responding. Try again after ensuring that the {0} card is present and is not resetting.	Refer to the error message text.
EID-3403	The administrative state transition has not been attempted on the monitored port.	Refer to the error message text.
EID-3404	The far end IP address could not be set on the {0} termination. The IP address cannot be: loopback (127.0.0.0/8) class D (224.0.0.0/4) class E (240.0.0.0/4) broadcast (255.255.255.255/32) internal {1}	Refer to the error message text.
EID-3405	You cannot change card parameters with port {0} in {1} state. Click "Reset" to revert the changes.	Refer to the error message text.
EID-4000	The {0} ring name cannot be changed now because a {0} switch is active.	You cannot change the ring name because a switch of the same ring type is active.
EID-4001	The {0} node ID cannot be changed now because a {0} switch is active.	You cannot change the ring ID because a switch of the same ring type is active.
WID-4002	CAUTION: Reverting to an earlier software release may result in TRAFFIC LOSS and loss of connectivity to the node. It may require onsite provisioning to recover. If the node was running {0} before, reverting will restore the {0} provisioning, losing any later provisioning. If the node was running some other version, reverting will LOSE ALL PROVISIONING. {1} {2}	Refer to the warning message text.
EID-4003	The Cisco IOS console is disabled for the card in Slot {0}.	The card may not be an IOS-based card or it may be rebooting.
EID-4004	An error occurred while canceling the software upgrade.	CTC encountered an error while cancelling the software upgrade.
EID-4005	{0} encountered while performing a database backup.	CTC encountered the specified error during database backup.
EID-4006	The file {0} does not exist or cannot be read.	Refer to error message.
EID-4007	The size of the file {0} is zero.	The size of the file that is being backed up or restored is zero.
WID-4008	A software upgrade is in progress. {0} cannot proceed during a software upgrade. Please try again after the software upgrade has completed.	The specified action cannot be performed during a software upgrade. You must try after the upgrade process is completed.
EID-4009	{0} encountered while restoring the database.	CTC encountered the specified error while restoring the database.

Table 4-1 Error Messages (continued)

Error Warning ID	Error Warning Message	Description
EID-4010	The operation was terminated because: {0}	Refer to the error message text.
EID-4011	An error occurred during provisioning: {0}	Refer to the error message text.
EID-5000	A valid route cannot be found for the tunnel change request.	Refer to the error message text.
EID-5001	The tunnel could not be changed.	Refer to the error message text.
EID-5002	The tunnel could not be restored and must be recreated manually.	Refer to the error message text.
EID-5003	The circuit roll failed. {0}	Refer to the error message text.
EID-5004	There is already one four-fiber {0} provisioned on the set of nodes involved in {1}. The maximum number of four-fiber {0} rings has been reached for that node.	There is already one 4F BLSR provisioned on the set of nodes involved in the ring. The maximum number of 4F BLSR rings has been reached for that node.
WID-5005	A non-zero hold-off time can violate switching time standards, and should only be used for a circuit with multiple path selectors.	Refer to the warning message text.
WID-5006	Warning: A different secondary {0} node should only be used for DRI or open-ended path protected circuits.	You should use different secondary end point only for DRI or open-ended path protected circuits.
WID-5007	If you change the scope of this view, the contents of this profile editor will be lost.	Refer to the warning message text.
WID-5008	Please ensure that all the protection groups are in proper states after the cancellation.	Refer to the warning message text.
WID-5009	The circuit {0} is not upgradable. No {1} capable {2}s are available at the node {3}.	No VT capable STSs are available at the node.
EID-5010	The domain name already exists.	Refer to the error message text.
EID-5011	The domain name cannot exceed {0} characters.	You may have reached the maximum number of characters.
WID-5012	The software load on {0} does not support the addition of a node to a 1+1 protection group.	Refer to the warning message text.
EID-5013	{0} does not support the bridge and roll feature. Please select a different port.	The specified port does not support Bridge and Roll.
EID-5014	An automatic network layout is already in progress. Please wait for it to complete before running it again.	You must for the automatic network layout to complete before running it again.
WID-5015	{0} cannot be applied to {1}.	You cannot apply the admin state operation, specified by {0}, to port count, specified by {1}.
EID-5016	An error occurred while attempting to provision the {0}. {1}	CTC encountered an error while provisioning the card.

Table 4-1 Error Messages (continued)

Error Warning ID	Error Warning Message	Description
EID-5017	Provisioning could not be rolled back. The {0} might be left in an INCOMPLETE state and should be manually removed.	You may have to remove the BLSR manually as it was left incomplete.
EID-5018	{0} is a(n) {1} node and cannot be added to a(n) {2} network.	You cannot add the node {0} of type {1} to the host node of type {2}. This prevents you from hosting both SONET and SDH nodes in the same session.
EID-5019	The manual path trace mode for this equipment does not support an expected string consisting of all null characters. Please change the expected string or the path trace mode.	The path trace mode does not support strings that consist of null characters. You must either change the expected string or the path trace mode.
EID-5020	Software activation is in progress. Provisioning is not allowed.	Refer to the warning message text.
EID-5021	Software activation is in progress. {0} is not allowed.	Refer to the error message text.
WID-5022	Warning: Ethergroup circuits are stateless (that is, always in service). The current state selection of {0} will be ignored.	Refer to the warning message text.
EID-5023	CTC cannot communicate with the node. The operation failed.	CTC encountered a network communication error. Connectivity between CTC and the NE was disrupted, either transiently or permanently.
EID-5024	The overhead circuit will not be upgraded.	Refer to the error message text.
WID-5025	The path targeted for this switch request is already active. The switch request can be applied, but traffic will not switch at this time.	Refer to the warning message text.
EID-5026	An ONS 15600 cannot serve as the primary or secondary node in a four-fiber {0} circuit. Please change your ring and/or node selections so that an ONS 15600 is not chosen as the primary or secondary node in this four-fiber {1} circuit.	Refer to the error message text.
WID-5027	The {0} Edit dialog box for the ring {1} has been closed due to significant provisioning changes. These changes might only be transitory, so you can reopen the {0} Edit dialog box to view the updated state.	Re-open the BLSR/MS-SPRing edit window to view the updated state of the ring.
WID-5028	Warning: This operation should only be used to clean up rolls that are stuck. It might also affect completeness of the circuit. Is it OK to continue with the deletion?	Refer to the warning message text.
EID-5029	A software downgrade cannot be performed to the selected version while an SSXC card is inserted in this shelf. Please follow the steps to replace the SSXC with a CXC card before continuing the software downgrade.	Refer to the error message text.
EID-5030	A software downgrade cannot be performed at the present time.	Try the software downgrade later.
WID-5031	Canceling a software upgrade during a standby TSC clock acquisition might result in a traffic outage.	Refer to the warning message text.
EID-5032	An error occurred while accepting the load.	Refer to the error message text.

Table 4-1 **Error Messages (continued)**

Error Warning ID	Error Warning Message	Description
EID-5033	The profile could not be loaded. An error occurred while decoding the characters.	CTC detected an error while decoding characters and could not load the profile.
EID-5034	The profile could not be loaded. An error occurred while trying to recognize the file format.	CTC detected an error and could not load the profile.
EID-5035	The profile could not be loaded. An error occurred while reading the file.	CTC could not read the file and is therefore unable to load the profile.
EID-5036	The GNE hostname {0} is invalid.	The specified host name is invalid. CTC could not resolve the host name to any valid IP address
EID-5037	Provisionable patchcords cannot be created between transponder trunk ports and multiplexer/demultiplexer ports on the same node.	You must create provisionable patchcords between transponder trunk ports and mux/demux ports that are on different nodes.
EID-5038	Provisionable patchcords created between transponder trunk ports and multiplexer/demultiplexer ports must use the same wavelength: {0} is not equal to {1}.	Wavelengths used by provisionable patchcords for transponder trunk ports and mux/demux ports must be the same.
EID-5039	Provisionable patchcords created between transponder trunk ports and multiplexer/demultiplexer ports must use the same wavelength: {0} is not equal to {1}. Please provision the {2} wavelength on {3}.	Transmitter and receiver port wavelengths are not equal. Provision the receiver and transmitter wavelengths on transmitter and receiver ports respectively.
EID-5040	Provisionable patchcords created between OC3/OC12 ports and multiplexer/demultiplexer ports are not supported.	Refer to the error message text.
EID-5041	Provisionable patchcords created between gray OC-N trunk ports and multiplexer/demultiplexer ports are not supported.	Refer to the error message text.
EID-5042	Provisionable patchcords created between OC-N trunk ports and multiplexer/demultiplexer ports must use the same wavelength: {0} is not equal to {1}.	Wavelengths used by provisionable patchcords for OC-N trunk ports and mux/demux ports must be the same.
WID-5043	Warning: Only the line card was provisioned. The wavelength compatibility check was skipped.	Refer to the warning message text.
EID-5044	Virtual links can be used only for OCH-Trail circuits.	Refer to the error message text.
EID-5045	The virtual link does not have wavelengths available.	Set wavelengths for the virtual link and proceed.
WID-5046	Warning: if you select "Use OCHNC Direction," your circuit will be limited to nodes prior to release 07.00.	Refer to the warning message text.
EID-5047	Provisionable patchcords created between OC3/OC12 ports are not supported.	Refer to the error message text.
EID-5048	Provisionable patchcords created between gray OC-N trunk ports are not supported.	Refer to the error message text.

Table 4-1 Error Messages (continued)

Error Warning ID	Error Warning Message	Description
EID-5049	Provisionable patchcords created between gray OC-N trunk ports and multiplexer/demultiplexer ports are not supported.	Refer to the error message text.
EID-5050	The element model could not be found. {0}	The specified Element Model cannot be located.
WID-5051	The port state cannot be indirectly transitioned because the port aggregates OCHCC circuits: if the port state needs to be changed, edit it directly through port provisioning.	Refer to the warning message text.
EID-5052	The operation is not valid for the connection type.	You may have selected the incorrect switch.
EID-5053	The operation cannot be performed because the connection is under test access.	Refer to the error message text.
EID-5054	The TL1 tunnel could not be opened. {0}	Refer to the error message text.
EID-5055	Some patchcords were not deleted. Patchcords cannot be deleted if they are incomplete or support any circuits, or if the nodes supporting them are not connected.	Refer to the error message text.
EID-5056	This PPC cannot be deleted because one or more circuits are provisioned over it.	Remove the circuits provisioned over the provisionable patchcord before trying to delete it.
EID-5057	The addition of the last node has not yet finished. Please wait before trying to add a new node.	Refer to the error message text.
EID-5058	An OCHNC upgrade is applicable only to bidirectional circuits.	Refer to the error message text.
EID-5059	The OCHNC upgrade failed. One or more communication failures occurred during the operation.	CTC encountered a complete failure while upgrading optical channel network connection.
EID-5060	The OCHNC upgrade partially failed. One or more communication failures occurred during the operation. Create the OCHCC manually.	CTC encountered a partial failure while upgrading an optical channel network connection.
EID-5061	The overhead circuit source and destination must reside on the same shelf.	Refer to the error message text.
EID-5062	A four-fiber {0} cannot be created using three cards.	A four-fiber BLSR needs four cards.
WID-5063	The profile "{0}" includes a change to the OPEN-SLOT alarm severity. This change is disallowed for the ONS 15600. "{1}" will continue to use the OPEN-SLOT severity of MN that is included in the default configuration. Other changes from the "{2}" profile were successfully applied to {3}".	Refer to the warning message text.
EID-5064	{0} {1}	This indicates the status of path protection switching.

Table 4-1 Error Messages (continued)

Error Warning ID	Error Warning Message	Description
WID-5065	If you apply routing constraints to more than {0} nodes, performance might be affected and the operation might require more time than expected. Select Yes if you intend to proceed in spite of this risk, or No if you prefer to review your selection.	Refer to the warning message text.
WID-5066	The routing constraints will be lost. Are you sure you want to reset your changes?	Refer to the warning message text.
WID-5067	The routing constraints will be lost. Are you sure you want to leave this panel?	Refer to the warning message text.
EID-5068	The routing constraints could not be applied.	Refer to the error message text.
EID-5069	A source node cannot be added to either of these lists.	Select a node other than the source node to add to the route.
EID-5070	A destination node cannot be added to either of these lists.	Select a node other than the destination node to add to the route.
EID-5071	This node already belongs to one of these lists.	The node is already selected either in include or exclude list in the OCH circuit.
EID-5072	An OCH-Trail tunnel link was found but without any associated circuit.	Create an OCH-Trail circuit associated with the link.
EID-5073	You are creating an unprotected link from a protected port. Do you want to continue?	Refer to the error message.
EID-5074	Deleting OCH DCN circuits will cause a loss of connectivity to nodes in the circuit path that do not have other DCN connections. Do you want to continue?	Refer to the error message.
EID-5075	The VLAN ID must be a number between 1 and 4093.	Enter a number between 1 and 4093.
EID-5076	An error occurred while provisioning the VLAN ID. The VLAN ID is already present in the current profile	Select a VLAN ID that is not present in the current profile.
EID-5077	An error occurred while provisioning the VLAN database profile. {0}	CTC could not save the VLAN profile to the file name mentioned.
EID-5078	The VLAN merge is not complete. You forgot to fill {0} record(s).	Fill in the number of records specified and then proceed.
EID-5079	An error occurred while validating the provisionable patchcord.	Refer to the error message text.
EID-5080	No rolls are available.	You cannot delete a roll without selecting a roll.
EID-5081	An error occurred while tracing the RPR ring: {0}	The circuit reference is invalid.

Table 4-1 Error Messages (continued)

Error Warning ID	Error Warning Message	Description
EID-5082	{0} does not support: - Low-order circuits that have both {1}-protected and {2}-protected spans and that cross a node that does not have low-order cross-connect capability. - High-order circuits that carry low-order circuits with the parameters described above.	Refer to the error message text.
EID-5083	This circuit is not the same size as the existing circuit {0}. This circuit has size {1} and the existing circuit has size {2}.	During an RPR circuit creation ML card, the new circuit size and the existing circuit size must be the same.
EID-5084	The Trunk model could not be found. {0}	The trunk specified is not found.
EID-5085	The maximum number of VLAN DB profiles is {0}.	Refer to the error message.
EID-5086	The circuit roll failed. You cannot bridge and roll the selected circuit because it has a monitor circuit.	Refer to the error message.
EID-6000	This platform does not support power monitoring thresholds.	Refer to the error message text.
EID-6001	One of the XC cards has failures or is missing.	Check whether all the cross-connect cards are installed and working.
EID-6002	One of the XC cards is locked.	Unlock the cross-connect card.
EID-6003	The OSC termination could not be created. This ring ID is already assigned.	Enter a new ID for the ring.
EID-6004	A system reset cannot be performed while a BLSR ring is provisioned on the node.	Remove the BLSR from the node and continue with the reset procedure.
EID-6005	The timing references could not be assigned. - Only two DS1 or BITS interfaces can be specified. - DS1 interfaces cannot be retimed and used as a reference. - BITS-2 is not supported on this platform.	Refer to the error message text.
EID-6006	The timing references could not be assigned. - An NE reference can only be used if the timing mode is LINE. - A BITS reference can only be used if the timing mode is not LINE. - A Line reference can only be used if the timing mode is not EXTERNAL.	Refer to the error message text.
EID-6008	SF BER and SD BER are not provisionable on the protect line of a protection group.	Refer to the error message text.
WID-6009	If autoadjust GFP buffers is disabled, GFP buffers available must be set to an appropriate value based on the distance between the circuit endpoints.	Refer to the warning message text.
WID-6010	If auto detection of credits is disabled, credits available must be set to a value less than or equal to the number of receive credits on the connected FC endpoint.	Refer to the warning message text.

Table 4-1 Error Messages (continued)

Error Warning ID	Error Warning Message	Description
WID-6011	Ingress idle filtering should be turned off only when required to operate with non-Cisco Fibre Channel/FICON-over-SONET equipment.	Refer to the warning message text.
EID-6012	The retiming configuration could not be changed because there are circuits on this port.	You cannot change the timing configuration on this port unless the circuits on this port are deleted.
EID-6013	The NTP/SNTP server could not be changed. {1}	Refer to the error message text.
EID-6014	The operation failed because the reference state is OOS.	Change the Out-of-service state to Active.
EID-6015	The distance extension cannot be disabled if the port media type is FICON 1Gbps ISL or FICON 2Gbps ISL.	Refer to the error message text.
EID-6016	The card mode cannot be changed to Fibre Channel Line Rate if the port media type is FICON 1Gbps ISL or FICON 2Gbps ISL.	Refer to the error message text.
EID-6017	The destination of a {0} route cannot be a node IP address.	A node IP address cannot be the destination for a static route.
EID-6018	The destination of a {0} route cannot be the same as the subnet used by the node.	Refer to the error message text.
EID-6019	The destination of a static route cannot be 255.255.255.255	The network address such as 255.255.255.255 is not valid. Enter a valid address.
EID-6020	The destination of a static route cannot be the loopback network (127.0.0.0/8).	Refer to the error message text.
EID-6021	The subnet mask length for a non default route must be between 8 and 32.	Length of subnet mask must be within the specified range.
EID-6022	The subnet mask length for a default route must be 0.	Refer to the error message text.
EID-6023	The destination of a {0} route cannot be an internal network{1}.	The destination of a static route must not be an internal network.
EID-6024	The destination of a {0} route cannot be a class D (224.0.0.0/4) or class E (240.0.0.0/4) address.	The destination of a static route must not be a class D or class E address.
EID-6025	The destination of a {0} route cannot be a class A broadcast address (x.255.255.255/8).	The destination of a static route must not be a class A broadcast address. It should be (xxx.0.0.0).
EID-6026	The destination of a {0} route cannot be a class B broadcast address (x.x.255.255/16).	The destination of a static route must not be a class B broadcast address.
EID-6027	The destination of a {0} route cannot be a class C broadcast address (x.x.x.255/24).	The destination of a static route must not be a class C broadcast address.
EID-6028	The destination of a {0} route cannot be the subnet broadcast address associated with a node IP address.	The destination of a static route must not be a subnet broadcast address of a node IP.

Table 4-1 Error Messages (continued)

Error Warning ID	Error Warning Message	Description
EID-6029	The next hop of a static route cannot be the same as the destination of the route or an internal network{0}.	Static route must have the default route as the next hop, and not destination of the route or internal network.
EID-6030	The next hop of a static default route must be the provisioned default router.	The default route is selected for networks that do not have a specific route.
EID-6031	No more static routes can be created.	You have reached the maximum number of static routes.
EID-6032	This static route already exists.	Refer to the error message text.
EID-6033	A previous operation is still in progress.	Another operation is in progress. You must try after sometime.
EID-6035	The parent entity does not exist.	Refer to the error message text.
EID-6036	The parent PPM entity does not exist.	Create a parent entity for the PPM.
EID-6037	This equipment type is not supported.	CTC does not support this equipment.
EID-6038	The PPM port is invalid.	Refer to the error message text.
EID-6039	The card is part of a regeneration group.	Select another card.
EID-6040	Out of memory.	Refer to the error message text.
EID-6041	The port is already present.	Refer to the error message text.
EID-6042	The port is used as timing source.	Choose another port because the selected port is being used as a timing source.
EID-6043	A DCC or GCC is present.	Refer to the error message text.
EID-6044	The card or port is part of protection group.	Refer to the error message text.
EID-6045	The port has overhead circuit(s).	Refer to the error message text.
EID-6046	The ITU-T G.709 configuration is not compatible with the data rate.	Refer to the error message text.
EID-6047	The port cannot be deleted because its service state is OOS-MA,LPBK&MT.	To delete the port, you must change the port state to OOS-DSBLD.
EID-6048	{0} is {1}.	The trunk port is in the wrong state to carry out the action.
EID-6049	The card operating mode of {0} is not supported.	CTC does not support the mode of operation requested on the card.
EID-6050	Some {0} terminations were not {1}d. {2}	Refer to the error message text.
WID-6051	All {0} terminations were {1}d successfully. {2}	Refer to the warning message text.
EID-6052	The authentication key can not be blank.	Enter an authentication key.
EID-6053	No more SNMP trap destinations can be created.	You have reached the maximum number of SNMP trap destinations.
EID-6054	{0} is not a valid IP address for an SNMP trap destination.	The IP address specified is not a valid receiver of SNMP traps.

Table 4-1 Error Messages (continued)

Error Warning ID	Error Warning Message	Description
EID-6055	The IP address is already in use.	Refer to the error message text.
EID-6056	The SNMP trap destination is invalid. {0}	The specified SNMP trap destination is invalid. Choose another destination.
WID-6057	Changing the card mode will result in an automatic reset.	Refer to the warning message text.
EID-6058	The maximum number of IP-over-CLNS tunnels has been exceeded.	Refer to the error message text.
EID-6059	The specified IP-over-CLNS tunnel already exists!	Specify another IP Over CLNS tunnel.
EID-6060	An error occurred while trying to {0} an IP-over-CLNS tunnel entry: {1}.	Refer to the error message text.
EID-6061	An error occurred while deleting the IP-over-CLNS tunnel entry.	CTC encountered an error while deleting the IP Over CLNS tunnel entry.
EID-6062	The selected IP-over-CLNS tunnel does not exist.	Create a IP Over CLNS tunnel.
EID-6063	The selected router does not exist.	Create a router.
EID-6064	The MAA address list is full.	Refer to the error message text.
EID-6065	The selected area address is duplicated.	Enter another area address.
EID-6066	The primary area address cannot be removed.	Refer to the error message text.
EID-6067	The selected area address does not exist.	Choose another area address.
EID-6068	The IP-over-CLNS NSEL cannot be modified while there are IP-over-CLNS tunnel routes provisioned.	You cannot change the NSEL address if tunnels are provisioned.
EID-6069	The node is currently in ES mode. Only Router 1 can be provisioned.	An End System needs only one provisioned router.
EID-6070	No router was selected.	Select a router.
EID-6071	The TARP data cache cannot be flushed.	You cannot flush the cache in the Tunnel identifier Address Resolution Protocol (TARP) state.
EID-6072	The TARP data cache entry cannot be added: {0}	You cannot add the specified cache entry.
WID-6073	A TARP request has been initiated. Try refreshing the TARP data cache later.	Refer to the warning message text.
EID-6074	End system mode only supports one subnet.	Refer to the error message text.
EID-6075	An error occurred while trying to remove a MAT entry. The entry does not exist.	CTC is removing the MAT entry.
EID-6076	An error occurred while trying to {0} a TARP manual adjacency entry: {1}	CTC cannot add the specified adjacency entry for reasons unknown.
EID-6077	The area address must be between 1 and 13 bytes long, inclusive.	The area address should not be more than 13 characters.
EID-6078	A TDC entry with this TID {0} does not exist in the table.	The specified Tunnel Identifier does not exist.

Table 4-1 Error Messages (continued)

Error Warning ID	Error Warning Message	Description
EID-6079	A TDC entry with this TID {0} could not be removed. Please verify that TARP is enabled.	You must enable TARP to remove the TDC entry.
WID-6080	Router {0} does not have an area address in common with Router 1. Switching from IS L1/L2 to IS L1 in this case will partition your network.	Refer to the warning message text.
EID-6081	The limit of 10 RADIUS server entries has been reached.	CTC does not allow more than 10 RADIUS servers.
EID-6082	{0} cannot be empty.	The Shared Secrets field should not be empty.
EID-6083	The entry you selected for editing has been altered by another user. The changes cannot be committed.	Refer to the error message text.
EID-6084	The RADIUS server entry already exists.	Specify another RADIUS server entry.
WID-6085	Disabling shell access will prevent Cisco TAC from connecting to the vxWorks shell to assist users.	Refer to the warning message text.
EID-6086	The card cannot be changed because card resources are in use.	The card you are trying to remove is being used. Cannot change the card.
EID-6087	The card cannot be changed because the card type is invalid or incompatible.	Refer to the error message text.
EID-6088	This line cannot be put into loopback while it is in use as a timing source.	Refer to the error message text.
EID-6089	The interface was not found. {0}	CTC cannot find the specified interface.
EID-6090	The interface type is not valid for this operation. {0}	Choose another interface.
EID-6091	The current state of the interface prohibits this operation. {0}	The port is in an invalid state to set a loopback.
EID-6092	This operation is prohibited for this interface. {0}	CTC does not allow this operation for the specified interface.
EID-6093	The maximum number of TARP data cache entries has been exceeded.	You have exceeded the number of characters permitted.
EID-6094	The maximum number of manual adjacency table entries has been exceeded.	Refer to the error message text.
EID-6095	The AIS/Squelch mode is invalid.	Refer to the error message text.
EID-6096	A default IP-over-CLNS tunnel route is only allowed on a node without a default static route and a default router of 0.0.0.0.	Refer to the error message text.
EID-6097	The authorization key does not comply with Cisco IOS password restrictions. {0}	Specify another authorization key.
EID-6098	A default static route is not allowed when a default IP-over-CLNS tunnel exists.	Refer to the error message text.
EID-6099	You cannot create a subnet on a disabled router.	Create the subnet on an active router.
WID-6100	Disabling a router that has a provisioned subnet is not recommended.	Refer to the warning message text.

Table 4-1 Error Messages (continued)

Error Warning ID	Error Warning Message	Description
EID-6101	The MAT entry already exists.	Refer to the error message text.
WID-6102	The new card has less bandwidth than the current card. Circuits of size VT15 and larger will be deleted.	Refer to the warning message text.
EID-6103	The TDC entry already exists.	Specify another entry for TARP Data Cache.
EID-6104	APC ABORTED.	Automatic Power Control is aborted.
EID-6105	The 'Change Card' command is valid for MRC cards only when Port 1 is the sole provisioned port.	Refer to the error message text.
EID-6106	To delete all RADIUS server entries, RADIUS authentication must be disabled.	Disable Radius authentication and proceed.
EID-6107	The node failed to restart the TELNET service on the selected port. Try using another unreserved port that is not being used within the following ranges: 23, 1001-9999 (with the exception of 1080, 2001-2017, 2361, 3081-3083, 4001-4017, 4022, 4081, 4083, 5000, 5001, 7200, 9100, 9300, 9401).	Refer to the error message text.
EID-6108	That port is already in use.	Restart a TELNET session.
EID-6109	A section trace is active on the trunk port. The action cannot be completed.	Actions such as putting the port in an incomplete state are not permitted while a section trace is active.
EID-6110	The maximum number of TARP requests has been reached.	You have exceeded the maximum number of TARP requests.
EID-6111	The card in Slot {0} cannot be removed from the protection group while its traffic is switched.	Refer to the error message text.
EID-6112	An error occurred while adding a shelf: {0}	The shelf ID specified is invalid or already exists, the equipment does not support multishelf, the specified shelf position is out of range, or the specified shelf position is already in use.
EID-6113	An error occurred while deleting a shelf: {0}	One or more of the equipment modules (provisioned virtual links, provisioned server trails, provisioned protection groups, or provisioned DCCs) in the shelf is currently in use. Delete cards from all the slots and try again.
EID-6114	The maximum number of supported shelves has already been provisioned.	Refer to the error message text.
EID-6115	There are bad or duplicate shelf positions. Valid rack numbers are {0} to {1}. Valid rack positions are {2} to {3}.	Refer to the error message text.
EID-6116	CTC attempted to access an OCH-Trail connection that has been destroyed.	Software has prevented an attempt to access an OCH trail.

Table 4-1 Error Messages (continued)

Error Warning ID	Error Warning Message	Description
EID-6117	CTC attempted to access an OCH-Trail audit that has been destroyed.	The resource cannot be accessed because it is released or fully utilized.
WID-6118	The following slots are provisioned but do not have cards installed: {0} CTC will assume they are ITU-T interfaces.	Refer to the warning message text.
EID-6119	The shelves could not be rearranged. {0}	One of the following conditions is present: duplicate shelf positions, invalid shelf positions, or concurrent movement (two CTC sessions are attempting to rearrange the shelves at the same time.)
EID-6120	This equipment does not support multishelf.	Refer to the error message text.
WID-6121	This internal patchcord cannot be provisioned because the endpoints have no compatible wavelengths.	The end points of an internal patchcord should have compatible wavelengths.
EID-6122	The wizard could not be started. {0}	CTC was unable to initiate the wizard due to the specified reason.
EID-6123	The OSI request can not be completed successfully.	A communication failure occurred.
EID-6124	The ALS recovery pulse interval is invalid.	Refer to the error message text.
EID-6125	The ALS recovery pulse duration is invalid.	Refer to the error message text.
EID-6126	The current setting does not support the specified ALS mode.	Refer to the error message text.
EID-6127	All enabled routers are required to have the same area.	Refer to the error message text.
EID-6128	A software download is in progress. Configuration changes that result in a card reboot cannot take place during a software download. Please try again after the software download is done.	Refer to the error message text.
EID-6129	The payload configuration and card mode are incompatible.	Refer to the error message text.
EID-6135	A DCC is present.	A data communication channel (DCC) already exists.
EID-6136	An error occurred during provisioning: {0}	CTC was not able to provision the specified port or card.
EID-6137	Multishelf cannot be disabled. {0}	Multishelf is not supported on equipment, is already disabled, or modules on the shelf are currently in use.
EID-6138	The LAN configuration is invalid.	Verify the LAN configuration.
EID-6139	Invalid card(s) are present. Please remove all non-MSTP cards and try again.	Non-DWDM cards cannot be added to an a DWDM node. Remove the cards.
EID-6140	The shelf identifier for a subtended shelf cannot be provisioned through CTC. It must be changed using the LCD.	Refer to the error message text.
EID-6143	The DHCP server could not be changed.	Refer to the error message text.

Table 4-1 **Error Messages (continued)**

Error Warning ID	Error Warning Message	Description
EID-6144	The port provisioning cannot be changed when the port media is Undefined.	If the port is not pre-provisioned with the type of media that is going to be inserted, you cannot access any of the existing values for the port.
WID-6145	OSPF on LAN should only be enabled when the LAN routers run OSPF. Otherwise, the node will not be reachable from outside its subnet. RIP implementation only advertise routes in one direction to connected routers. It does not learn or distribute routes advertised by other routers. Also note that enabling OSPF on the LAN will temporarily cause the current list of static routes to stop being advertised to remote nodes and only be used locally.	Refer to the warning message text.
WID-6146	Deleting the protection group while in a switched state might cause a loss of traffic. It is recommended that you verify switch states before proceeding.	Refer to the warning message text.
EID-6147	The protection switch could not be performed.	A protection switch cannot be performed during protection operations like manual switch, lockout, and so on.
EID-6148	A server trail is present.	Refer to the warning message text.
EID-6149	The LAPD MTU size must be greater than or equal to the {0} LSP buffer size {1}. Alternatively, you can decrease the {0} LSP buffer size to {2}.	Refer to the error message text.
EID-6150	The value is out of range.	Enter a value that is within the range.
EID-6151	The minimum span loss must be less than the maximum span loss.	Refer to the error message text.
EID-6152	The "Use NTP/SNTP Server" field is checked. Enter the NTP/SNTP server IP address or server name.	Enter the NTP/SNTP server name. To leave this field empty, uncheck the "Use NTP/SNTP Server" and proceed.
EID-6153	The maximum frame size is invalid.	Refer to the error message text.
EID-6154	To combine unidirectional two-port provisioning and autonegotiation on the same port, autonegotiation must be set first.	Refer to the error message text.
EID-6155	Transponder mode cannot be provisioned with circuits on the card.	Refer to the error message text.
EID-6156	The transponder configuration is invalid.	The transponder is not configured properly.
EID-6157	The watermark values are either out of range or inconsistent.	Enter valid watermark values.
EID-6179	The 1+1 protection group is not optimized.	Refer to the error message text.
EID-6196	The equipment has failed or is missing.	Operation is requested on a failed or missing equipment.
EID-6197	Attributes cannot be changed when the port administrative state is {0}.	You cannot change the attributes when the port is in the specified administrative state.

Table 4-1 Error Messages (continued)

Error Warning ID	Error Warning Message	Description
WID-6204	This action will cause the node to reboot. When provisioning in single-shelf mode, Shelf {0} of the node that you connect to must be properly preprovisioned or you will lose traffic. Use the LCD to return to single-shelf mode. CTC cannot be used for this. Changing from subtended shelf mode to single-shelf mode could be traffic-affecting.	Refer to the warning message text.
EID-6205	The interlink port is not provisioned.	The user creates an ADM peer group without interlink ports.
EID-6206	The ADM peer group has already been created on the peer card.	The user creates an ADM peer group involving an ADM card inserted in a peer group.
EID-6207	This card is not in the ADM peer group.	The selected ADM card is not involved in an ADM peer group.
EID-6208	The payload is not OTU2.	Refer to the error message text.
EID-6209	The side is already defined by the node.	During the creation of a side on node, a side is already defined.
EID-6210	No side was selected.	The user requests an operation on a side, but no side is selected.
EID-6211	The side was not deleted.	CTC could not delete the selected side successfully.
EID-6212	One of the ports is connected to a patchcord or virtual link.	An operation on a port was not performed because the port is connected to a patchcord or a virtual link.
EID-6213	It is not possible to associate the side to the two ports.	During the creation of a side it is not possible to associate the selected ports to the new side.
EID-6214	The port is already assigned to a side.	The selected port is already assigned to a side.
EID-6215	Error provisioning the CVLAN ID. Enter a valid number or range between 0 and 4094.	The entered CVLAN ID was out of the admitted range.
EID-6216	Changing card will reset the optical thresholds to the default setting and may affect the optical connection. The optical connection will work only if the optical performance is compatible with {0} card. Please check the network design.	Refer to the error message text.
EID-6217	You cannot delete the {0} {1}.	You cannot delete {0} {1} because it is part of an ADM peer group or one or more circuits are provisioned on it.
EID-6218	Invalid ethernet duplex value	the Ethernet duplex value is invalid. Enter again.
EID-6219	Invalid committed info rate	The committed info rate value is invalid. Enter again.

Table 4-1 **Error Messages (continued)**

Error Warning ID	Error Warning Message	Description
EID-6220	Invalid mode value	The mode value is invalid. Enter again.
EID-6221	Invalid mtu value	The MTU value is invalid. Enter again.
EID-6222	Invalid flow control value	The flow control value is invalid. Enter again.
EID-6223	Invalid Network Interface Mode	The network interface mode value is invalid. Enter again.
EID-6224	Invalid ingress COS value	The ingress COS value is invalid. Enter again.
EID-6225	Invalid ethertype value	The Ethertype value is invalid. Enter again.
EID-6226	Invalid buffer size value	The Buffer size value is invalid. Enter again.
EID-6227	Invalid egress QOS value	The egress QOS value is invalid. Enter again.
EID-6228	Invalid QinQ working Mode	The QinQ working mode is invalid. Enter again.
EID-6229	Configured protection status Not Supported	The protection status is not supported
EID-6230	The number of provisioned entries exceeds the limit	Refer to the error message text.
EID-6231	This is not a valid VLAN ID.	Entered VLAN ID is not present in the database file.
EID-6232	The VLAN remapping ID is not allowed.	Refer to the error message text.
EID-6233	The CVLAN is duplicated.	You cannot have identical CVLAN IDs.
EID-6234	The VLAN ID is out of range.	The VLAN ID entered is out of range.
EID-6235	This is not a valid VLAN name.	The entered VLAN name exceeds the number of characters (32) allowed.
EID-6236	The protected VLAN number exceeds the maximum allowed.	The user enters more than 256 protected VLAN in the VLAN database.
EID-6237	The port is not in OOS disabled admin state	Refer to the error message text.
EID-6238	The VLAN ID is in use.	The entered VLAN ID is in use by a node.
EID-6239	APC wrong node side.	Refer to the error message text.
EID-6240	You cannot change the Admin State for an interlink port when it is part of an ADM peer group. This operation is not supported.	Refer to the error message text.
EID-6242	The protection slot is invalid.	You must select a valid protection slot.
EID-6243	The {0} address of {1} is invalid.	Refer to the error message text.
EID-6244	The mask of {0} is invalid.	The mask of the specified value is not valid.
EID-6245	The cost must be between 1 and 32767.	Refer to the error message text.
EID-6246	The {0} address cannot be {1}.	Refer to the error message text.
EID-6247	The authentication type is invalid.	Enter a valid authentication type.

Table 4-1 Error Messages (continued)

Error Warning ID	Error Warning Message	Description
EID-6248	The cost must between 1 and 15.	Refer to the error message text.
EID-6249	The port has a cross-connect.	Refer to the error message text.
EID-6250	The reversion time is invalid.	The reversion time is invalid. Enter again.
EID-6251	Invalid Margin For Span Aging. Value is not in the range 0 - 10.	Enter a value between 0 and 10.
EID-6252	The data cannot be retrieved because ANS parameters cannot be calculated on the node in its current configuration.	Refer to the error message text.
EID-6253	Invalid Margin For Span Aging.	Refer to the error message text.
EID-6254	SDH mode does not support timing references.	Timing reference is not supported by SDH mode.
EID-6255	Only DS1 interfaces with ESF line types support timing references.	Refer to the error message text.
EID-6256	sendDoNotUse and sendDoNotUseFF are mutually exclusive.	Refer to the error message text.
EID-6257	The termination is already in use.	Refer to the error message text.
EID-6258	The side is carrying services or traffic.	Refer to the error message text.
EID-6259	A pluggable module on Port 22 remains unmanaged.	Refer to the error message text.
EID-6260	You cannot delete this port. There was a severe architectural error related to the index of the pluggable trunk port object. Please contact technical support for assistance.	Refer to the error message text.
EID-6261	This is not a valid VLAN ID. The VLAN database is empty.	The user adds a row without a valid VLAN database loaded.
EID-6263	The equipment requires two slots.	The user provisions a double footprint card in a single slot.
EID-6264	The patchcord is duplicated.	Refer to the error message text.
EID-6265	The wavelength is in use by an OCH trail, a virtual link, or an internal patchcord.	Refer to the error message text.
EID-6266	The card cannot be changed because the port has not been provisioned.	Refer to the error message text.
EID-6267	Each port can have a maximum of 8 MAC addresses.	Refer to the error message text.
EID-6268	This server trail does not have a valid start or end.	Refer to the error message text.
EID-6269	The maximum number of server trails is 3743.	Refer to the error message text.
EID-6270	A unique server trail ID could not be allocated.	Refer to the error message text.
EID-6271	The server trail already exists.	Refer to the error message text.
EID-6272	The server trail size must not exceed the port bandwidth.	Refer to the error message text.

Table 4-1 *Error Messages (continued)*

Error Warning ID	Error Warning Message	Description
EID-6273	An OCH Trail circuit is active on the trunk port. To modify the ITU-T G.709 parameter, the circuit must be out of service.	Refer to the error message text.
EID-6274	Unable to restore this database: The software version cannot be obtained from the node. Please try again.	Refer to the error message text.

1. EID-3159 can appear if you attempt to perform another switching operation within a certain time interval. This interval is an algorithm of three seconds per working card in the protection group. The maximum interval is 10 seconds.



Numerics

1+1 protection

Force switch *see* external switching commands

Manual switch *see* external switching commands

APS channel byte failure [2-40](#)

APS invalid code condition [2-44](#)

disable switching [2-131](#)

far-end forced switch back to working condition [2-107](#)

optimized 1+1 APS primary facility condition [2-45](#)

2R logical object [2-20](#)

A

ADMIN-DISABLE [3-4](#)

ADMIN-DISABLE-CLR [3-4](#)

ADMIN-LOCKOUT [3-4](#)

ADMIN-LOCKOUT-CLR [3-4](#)

ADMIN-LOGOUT [3-5](#)

ADMIN-SUSPEND [3-5](#)

ADMIN-SUSPEND-CLR [3-5](#)

AICI-AEP logical object [2-20](#)

AICI-AIE logical object [2-20](#)

AIP

logical object [2-20](#)

MAC address location [2-132](#)

MEA [2-182](#)

replace [2-282](#)

air filter, replace [2-279](#)

AIS

AIS [2-37](#)

AIS-L [2-38](#)

AIS-P [1-136, 2-38](#)

AIS-V [1-135, 2-38](#)

AUTOSW-AIS [2-52](#)

FE-AIS [2-103](#)

ODUK-1-AIS-PM [2-190](#)

ODUK-2-AIS-PM [2-190](#)

ODUK-3-AIS-PM [2-190](#)

ODUK-4-AIS-PM [2-190](#)

ODUK-AIS-PM [2-190](#)

OTUK-AIS [2-193](#)

TX-AIS [2-251](#)

alarm logical objects

alarm index [2-23](#)

definition list [2-20](#)

alarms

alarms in this index appear individually by name

alphabetical list [2-11](#)

characteristics [2-32](#)

frequently used troubleshooting procedures [2-261](#)

list of critical alarms [2-2](#)

list of major alarms [2-3](#)

list of minor alarms [2-4](#)

states [2-35](#)

TL1 [2-1](#)

alarm troubleshooting [2-1 to 2-285](#)

alphabetical alarm list [2-11](#)

ALS [2-39](#)

AMI coding [2-149](#)

AMPLI-INIT [2-39](#)

AOTS logical object [2-20](#)

APC-CORR-SKIPPED [2-39](#)

APC-DISABLED [2-39](#)

APC-END [2-39](#)

APC-OUT-OF-RANGE [2-39](#)
 APC-WRONG-GAIN [2-40](#)
 APSB [2-40](#)
 APSCDFLTK [2-40](#)
 APSC-IMP [2-41](#)
 APSCINCON [2-42](#)
 APSCM [2-43](#)
 APSCNMIS [2-44](#)
 APSIMP [2-44](#)
 APS-INV-PRIM [2-45](#)
 APSMM [2-45](#)
 APS-PRIM-FAC [2-46](#)
 APS-PRIM-SEC-MISM [2-46](#)
 ARP [1-132](#)
 AS-CMD [2-47](#)
 AS-MT [2-48](#)
 AS-MT-OOG [2-48](#)
 asynchronous mapping [2-197](#)
 AUD-ARCHIVE FAIL [3-5](#)
 AUD-LOG-LOSS [2-49](#)
 AUD-LOG-LOW [2-49](#)
 AUTOLSROFF [2-50](#)
 automatic protection switching

- byte failure [2-40](#)
- channel failure on protect card [2-112](#)
- channel mismatch [2-43](#)
- invalid k bytes [2-41](#)
- mode mismatch failure [2-45](#)
- path protection alarms [2-53, 2-54, 2-55](#)
- path protection switch (condition) [2-54](#)
- ring switch failure [2-96](#)
- span switch failure [2-98](#)

automatic reset [2-52](#)
 AUTONEG-RFI [2-51](#)
 AUTORESET [2-52](#)
 AUTOSW-AIS [2-52](#)
 AUTOSW-LOP (STSMON) [2-53](#)
 AUTOSW-LOP (VT-MON) [2-53](#)
 AUTOSW-PDI [2-54](#)

AUTOSW-SDBER [2-54](#)
 AUTOSW-SFBER [2-54](#)
 AUTOSW-UNEQ (STSMON) [2-55](#)
 AUTOSW-UNEQ (VTMON) [2-55](#)
 AUTOWDMANS [3-5](#)
 AWG-DEG [2-56](#)
 AWG-FAIL [2-56](#)
 AWG-OVERTEMP [2-56](#)
 AWG-WARM-UP [2-56](#)

B

B8ZS [2-148, 2-149](#)
 BAT-FAIL [2-56](#)
 BER

- threshold range [2-218, 2-219](#)
- verify threshold level [2-275](#)

BIC logical object [2-20](#)

bit error rate *see* BER

BITS

- daisy-chained [1-138](#)
- errors [1-137](#)
- holdover timing [1-138](#)
- loss of frame [2-148](#)
- loss of signal [2-158](#)

BITS logical object [2-20](#)

BKUPMEMP [2-57](#)

BLSR

- change node ID number [2-262](#)
- change ring name [2-261](#)
- far-end protection line failure [2-112](#)
- improper configuration (alarms) [2-40](#)
- manual span condition [2-181](#)
- ring mismatch [2-208](#)
- ring switch failure [2-97](#)
- sqelch alarm [2-228](#)
- verify node visibility [2-262](#)

BLSROSYNC [2-58](#)

BLSR-RESYNC [3-5](#)

- BLSR-SW-VER-MISM [2-58](#)
 - BNC connector [2-203, 2-251](#)
 - BPLANE logical object [2-20](#)
 - BPV [2-58](#)
 - browser
 - applet security restrictions [1-126](#)
 - does launch Java [1-117](#)
 - limit Netscape colors [1-121](#)
 - reconfigure [1-118](#)
 - reset [1-121](#)
 - stalls during download [1-123](#)
 - supported [1-115](#)
 - unsupported [1-116](#)
-
- C**
- card reset
 - LED activity [2-260](#)
 - procedure [2-271](#)
 - cards
 - replace [2-274](#)
 - reset [2-274](#)
 - see also* cross-connect cards
 - see also* electrical cards
 - see also* OC-N cards
 - see also* TCC2 card
 - see also* TCC2P card
 - see also* CE-Series Ethernet cards
 - see also* E-Series Ethernet cards
 - see also* G-Series Ethernet cards
 - see also* ML-Series Ethernet Cards
 - CARLOSS
 - cause of TPTFAIL [2-249](#)
 - CE1000 [2-59](#)
 - CE100T [2-59](#)
 - CEMR [2-59](#)
 - E1000 [2-59](#)
 - E100T [2-59](#)
 - EQPT [2-61](#)
 - FC [2-63](#)
 - G1000 [2-63](#)
 - GE [2-65](#)
 - ISC [2-65](#)
 - ML100T, ML1000, MLFX, MLMR [2-66](#)
 - TRUNK [2-67](#)
 - carrier loss *see* CARLOSS
 - CASETEMP-DEG [2-67](#)
 - CBIT framing [1-46](#)
 - CE1000 logical object [2-20](#)
 - CE100T
 - logical object [2-20](#)
 - see also* CE-Series Ethernet cards
 - CEMR
 - logical object [2-20](#)
 - see also* CE-Series Ethernet cards
 - CE-Series Ethernet cards
 - carrier loss [2-59](#)
 - LED activity [2-260](#)
 - loopbacks [1-69](#)
 - terminal loopback condition [2-174](#)
 - transport layer failure alarm [2-248](#)
 - circuits
 - see also* hairpin circuits
 - see also* loopbacks
 - AIS-V alarm on DS3XM-6 or DS3XM-12 card [1-135](#)
 - bidirectional diagnostic circuits [1-110](#)
 - circuit state transition error [1-134](#)
 - delete [2-276](#)
 - generic procedures [2-275](#)
 - identify circuit state [1-134](#)
 - path-in-use error [1-130](#)
 - troubleshoot electrical circuits [1-9](#)
 - troubleshoot Ethernet circuits [1-68](#)
 - troubleshoot FC_MR-4 circuits [1-94](#)
 - troubleshoot optical circuits [1-47](#)
 - VT1.5 circuit creation error [1-136](#)
 - CLDRESTART [2-67](#)
 - COMIOXC [2-67](#)

- COMM-FAIL [2-68](#)
- conditions
- conditions are indexed individually by name*
 - characteristics [2-32](#)
 - list of not-alarmed conditions [2-6](#)
 - list of not-reported conditions [2-10](#)
- CONTBUS-A-18 [2-68](#)
- CONTBUS-B-18 [2-69](#)
- CONTBUS-DISABLED [2-69](#)
- CONTBUS-IO-A [2-70](#)
- CONTBUS-IO-B [2-71](#)
- CPP-INCAPABALE [2-72](#)
- critical alarms
- definition [2-33](#)
 - list of alarms [2-2](#)
- cross-connect cards
- LED activity during side switch [2-261](#)
 - main payload bus failure [2-75](#)
 - replace [2-274](#)
 - reset (side switch) [2-272](#)
 - test during a cross-connect loopback [1-20, 1-21](#)
 - test during a hairpin circuit [1-16, 1-17, 1-34, 1-35, 1-76, 1-77, 1-92, 1-93](#)
- cross-connect loopback
- description [1-8](#)
 - clear an OC-N card loopback circuit [2-277](#)
 - perform on a destination-node OC-N carrying an electrical circuit [1-18](#)
 - perform on a source-node STS carrying an electrical circuit [1-36](#)
 - perform on a source OC-N port [1-53](#)
- C-Series Ethernet cards
- facility loopback behavior [1-4](#)
 - terminal loopback behavior [1-6](#)
- CTC
- applet not loaded [1-117](#)
 - applet security restrictions [1-126](#)
 - cannot change node view to network view [1-122](#)
 - cannot launch [1-123](#)
 - colors appear incorrectly on UNIX workstation [1-121](#)
 - correct the core version build [1-128](#)
 - delete cache files [1-124](#)
 - gray node icon [1-126](#)
 - list of alarms [2-1](#)
 - log-in errors [1-117, 1-123, 1-126, 1-129](#)
 - loss of TCP/IP connection [2-61](#)
 - release interoperability problems [1-128](#)
 - slow operation or login problems [1-124](#)
 - username and password mismatch [1-129](#)
 - verifying PC connection [1-119](#)
- CTC_HEAP variable [1-122](#)
- CTNEQPT-MISMATCH [2-73](#)
- CTNEQPT-PBPROT [2-73](#)
- CTNEQPT-PBWORK [2-75](#)
- CTRL logical object [2-20](#)
- cyclic redundancy checking (CRC) [2-57](#)
-
- ## D
- database
- memory exceeded [2-77](#)
 - out of synchronization [2-77](#)
 - restore [1-114](#)
 - verify version [2-283](#)
- data communications network *see* DCN tool
- DATA-CRC [2-76](#)
- DATAFLT [2-77](#)
- DBBACKUP-FAIL [3-5](#)
- DBOSYNC [2-77](#)
- DBRESTORE-FAIL [3-6](#)
- DCC
- channel loss [2-83, 2-85](#)
 - connection loss [1-130](#)
 - create or verify DCC terminations [2-276](#)
 - delete a DCC termination [2-129](#)
 - limitations with OC-3 [1-137](#)
- DCN tool [1-113](#)
- DCU-LOSS-FAIL [2-78](#)
- default K alarm [2-40](#)

- diagnostic tests
 - bidirectional diagnostic circuit [1-110](#)
 - lamp test [1-108](#)
 - overview [1-107](#)
 - retrieve [1-110](#)
 - DISCONNECTED [2-78](#)
 - DS1 logical object [2-20](#)
 - DS3 logical object [2-21](#)
 - DS3-MISM [2-78](#)
 - DS3XM-12 card
 - AIS-V alarm and unused VT circuits [1-135](#)
 - clear a loopback circuit [2-277](#)
 - create a facility loopback [1-11, 1-29](#)
 - create a terminal loopback [1-25](#)
 - facility loopback behavior [1-4](#)
 - FEAC loopbacks [1-45](#)
 - incomplete circuit from DS-3 card [1-136](#)
 - terminal loopback behavior [1-6](#)
 - test and clear a facility loopback circuit [1-12, 1-30](#)
 - test and clear a terminal loopback circuit [1-26](#)
 - DS3XM-6 card
 - AIS-V alarm and unused VT circuits [1-135](#)
 - clear a loopback circuit [2-277](#)
 - create a facility loopback [1-11, 1-29](#)
 - create a terminal loopback [1-25](#)
 - facility loopback behavior [1-4](#)
 - FEAC loopbacks [1-45](#)
 - incomplete circuit from DS-3 card [1-136](#)
 - terminal loopback behavior [1-6](#)
 - test and clear a facility loopback circuit [1-12, 1-30](#)
 - test and clear a terminal loopback circuit [1-26](#)
 - DS-N cards
 - see also* DS3XM-12 card
 - see also* DS3XM-6 card
 - see also* electrical cards
 - DSP-COMM-FAIL [2-79](#)
 - DSP-FAIL [2-79](#)
 - DUP-IPADDR [2-79](#)
 - DUP-NODENAME [2-80](#)
 - DUP-SHELF-ID [2-80](#)
 - DWDM cards
 - GBIC compatibility [1-144](#)
 - OCH alarm object [2-22](#)
 - OCHNC-CONN alarm object [2-22](#)
-
- E**
- E1000
 - logical object [2-21](#)
 - see also* E-Series Ethernet cards
 - E100T
 - logical object [2-21](#)
 - see also* E-Series Ethernet cards
 - E1 logical object [2-21](#)
 - east/west mismatch alarm [2-90](#)
 - EC-1 card
 - loopback facility alarm [2-171, 2-175](#)
 - LOS [2-163](#)
 - see also* electrical cards
 - EC1 logical object [2-21](#)
 - EFM-ERR-FRM [3-6](#)
 - EFM-FRM-PER [3-6](#)
 - EFM-FRM-SEC [3-6](#)
 - EFM-RLBK-FAIL [3-6](#)
 - EFM-SYM-PER [3-7](#)
 - EHIBATVG [2-80](#)
 - EIAs
 - replace [2-282](#)
 - test during a facility loopback [1-14, 1-32](#)
 - electrical cable
 - CAT-5 problems [1-118](#)
 - crimp [1-141](#)
 - test during a facility loopback [1-13, 1-30](#)
 - electrical cards
 - clear loopbacks [2-278](#)
 - create a facility loopback [1-10, 1-28](#)
 - create a hairpin circuit [1-15, 1-33](#)
 - create a terminal loopback [1-23](#)

- DS-3 idle condition [2-131](#)
- facility loopback behavior [1-4](#)
- facility loopback example [1-3](#)
- failure to switch [2-95](#)
- frame format mismatch [2-78](#)
- idle DS-3 signal [2-108](#)
- initiate a protection switch [2-265](#)
- LED activity [2-260](#)
- LOF [2-149, 2-150](#)
- loopback facility alarm [2-170, 2-175](#)
- loopback signal received [2-169](#)
- loss of signal [2-159, 2-160](#)
- reset [2-271](#)
- terminal loopback behavior [1-6](#)
- test and clear a facility loopback circuit [1-11, 1-29](#)
- test and clear a terminal loopback circuit [1-24](#)
- test and delete a hairpin circuit [1-16, 1-34](#)
- test during a facility loopback [1-13, 1-31](#)
- test during a terminal loopback [1-27](#)
- ELWBATVG [2-81](#)
- ENCAP-MISMATCH-P [2-81](#)
- ENVALRM logical object [2-21](#)
- EOC
 - EOC [2-83](#)
 - EOC-L [2-85](#)
 - GCC-EOC [2-117](#)
- EQPT
 - EQPT [2-86](#)
 - EQPT-DIAG [2-87](#)
 - EQPT-MISS [2-87](#)
 - logical object [2-21](#)
 - MEA [2-183](#)
- equipment failure
 - far-end DS-1 failure [2-104](#)
 - far-end DS-3 failure [2-105, 2-106](#)
 - hardware failure on reporting card [2-86](#)
 - missing fan-tray assembly [2-87](#)
 - software or hardware failure on reporting card [2-87](#)
- ERFI-P-CONN [2-88](#)
- ERFI-P-PAYLD [2-88](#)
- ERFI-P-SRVR [2-88](#)
- ERROR-CONFIG [2-89](#)
- error messages [4-1 to 4-49](#)
- ESCON logical object [2-21](#)
- E-Series Ethernet cards
 - carrier loss [2-59](#)
 - verify LED operation [1-109](#)
- Ethernet
 - see also* CE-Series Ethernet cards
 - see also* E-Series Ethernet cards
 - see also* G-Series Ethernet cards
 - see also* ML-Series Ethernet cards
 - cable with reversed receive pairs [2-137](#)
 - configure VLANs [1-133](#)
 - connectivity problems [1-131](#)
 - create a hairpin circuit [1-75, 1-91](#)
 - Tag/Untag port connectivity [1-132](#)
 - troubleshoot Ethernet circuit paths [1-68](#)
 - verify connections [1-131](#)
- ETH-LINKLOSS [2-90](#)
- E-W-MISMATCH [2-90](#)
- EXCCOL [2-92](#)
- excess collisions [2-93](#)
- EXERCISE conditions
 - EXERCISE-RING-FAIL [2-93](#)
 - EXERCISE-SPAN-FAIL [2-93](#)
- EXT [2-94](#)
- external switching commands
 - BLSR Force Ring condition [2-107](#)
 - BLSR Force Span condition [2-108, 2-114](#)
 - BLSR Lockout Protect Span condition [2-109](#)
 - BLSR Manual ring condition [2-180](#)
 - clear a 1+1 Force or Manual switch [2-264](#)
 - clear a BLSR switching command [2-270](#)
 - clear a lock-on or lockout [2-265](#)
 - clear a path protection span switch [2-267](#)
 - initiate a 1+1 Manual switch [2-263](#)
 - initiate a 1+1 Protection switch [2-262](#)

- initiate a 1:1 card switch command [2-265](#)
- initiate a BLSR exercise ring switch [2-269, 2-270](#)
- initiate a BLSR Force ring switch [2-268](#)
- initiate a BLSR Force span switch [2-268](#)
- initiate a BLSR lockout [2-269](#)
- initiate a BLSR Manual ring switch [2-269](#)
- initiate a BLSR Manual span switch [2-268](#)
- initiate a lock-on [2-264](#)
- initiate a lockout [2-265](#)
- initiate a path protection Force switch [2-266](#)
- initiate a path protection lockout [2-267](#)
- initiate a path protection switch [2-266](#)
- path protection Manual Ring condition [2-111](#)
- side switch a cross-connect card [1-21](#)

EXTRA-TRAF-PREEMPT [2-94](#)

EXT-SREF logical object [2-21](#)

F

- facility alarms, hierarchy [2-34](#)
- facility loopback
 - definition [1-2](#)
 - card view indicator [1-3](#)
 - clear an OC-N loopback circuit [2-276](#)
 - create on an intermediate-node Ethernet port [1-78](#)
 - perform on a destination-node electrical port [1-27](#)
 - perform on a destination-node Ethernet port [1-84](#)
 - perform on a destination-node FC_MR-4 card [1-103](#)
 - perform on a destination-node OC-N port [1-63](#)
 - perform on an intermediate-node Ethernet port [1-78](#)
 - perform on an intermediate node FC_MR-4 card [1-99](#)
 - perform on an intermediate node OC-N port [1-57](#)
 - perform on a source-node Ethernet port [1-69](#)
 - perform on a source-node OC-N port [1-48](#)
 - perform on source-node FC_MR-4 cards [1-94](#)
 - test a source electrical port [1-10](#)
- FAILTOSW [2-95](#)
- FAILTOSW-PATH [2-96](#)
- FAILTOSWR [2-96](#)
- FAILTOSWS [2-98](#)
- FAN [2-100](#)
- FAN logical object [2-21](#)
- fan-tray assembly
 - MEA [2-186](#)
 - missing unit alarm [2-87](#)
 - replace [2-281](#)
 - reseat [2-280](#)
- FAPS [2-100](#)
- FAPS-CONFIG-MISMATCH [2-101](#)
- far-end alarms, hierarchy [2-35](#)
- FC_MR-4 card
 - clear loopbacks [2-278](#)
 - facility loopback behavior [1-5](#)
 - facility loopback condition [2-172](#)
 - FC-NO-CREDITS alarm [2-101](#)
 - GFP-DE-MISMATCH alarm [2-118](#)
 - GFP-EX-MISMATCH [2-119](#)
 - GFP-NO-BUFFERS [2-120](#)
 - GFP-UP-MISMATCH [2-121](#)
 - LED test [1-109](#)
 - terminal loopback condition [2-176](#)
 - transport fail alarm [2-248](#)
 - troubleshoot circuits with loopbacks [1-94](#)
- FC-DE-NES [2-101](#)
- FC logical object [2-21](#)
- FCMR
 - logical object [2-21](#)
 - see also* FC_MR-4 card
- FC-NO-CREDITS [2-101](#)
- FDI [2-103](#)
- FEAC
 - alarms [1-47](#)
 - inhibit loopbacks [1-47](#)
 - send code [1-46](#)
- FE-AIS [2-103](#)
- FEC-MISM [2-103](#)
- FE-DS1-MULTLOS [2-103](#)
- FE-DS1-NSA [2-104](#)

FE-DS1-SA [2-104](#)
 FE-DS1-SNGLLOS [2-105](#)
 FE-DS3-NSA [2-105](#)
 FE-DS3-SA [2-106](#)
 FE-EQPT-NSA [2-106](#)
 FE-FRCDWKSWBK-SPAN [2-107](#)
 FE-FRCDWKSWPR-RING [2-107](#)
 FE-FRCDWKSWPR-SPAN [2-108](#)
 FE-IDLE [2-108](#)
 FE-LOCKOUTOFPR-SPAN [2-109](#)
 FE-LOF [2-109](#)
 FE-LOS [2-110](#)
 FE-MANWKSWBK-SPAN [2-110](#)
 FE-MANWKSWPR-RING [2-111](#)
 FE-MANWKSWPR-SPAN [2-111](#)
 FEPRLF [2-112](#)
 fiber
 faulty connections [1-139](#)
 verify connections [1-139](#)
 FIBERTEMP-DEG [2-112](#)
 Fibre Channel card *see* FC_MR-4 card
 FICON card *see* FC_MR-4 card
 firewall, invalid port number [4-12](#)
 FIREWALL-DIS [3-7](#)
 flash manager [2-57](#)
 flow rate [2-93](#)
 FORCED-REQ [2-112](#)
 FORCED-REQ-RING [2-113](#)
 FORCED-REQ-SPAN [2-114](#)
 Force switch *see* external switching commands
 FP-LINK-LOSS [2-114](#)
 FRCDSWTOINT [2-114](#)
 FRCDSWTOPRI [2-115](#)
 FRCDSWTOSEC [2-115](#)
 FRCDSWTO THIRD [2-115](#)
 FRCDWKSWBK-NO-TRFSW [3-7](#)
 FRCDWKSWPR-NO-TRFSW [3-7](#)
 free run synchronization [2-115](#)
 FRNGSYNC [1-138, 2-115](#)

FSTSYNC [2-116](#)
 FTA-MISMATCH [2-116](#)
 FUDC logical object [2-21](#)
 FULLPASSTHR-BI [2-116](#)

G

G1000
 logical object [2-21](#)
 see also G-Series Ethernet cards
 GAIN-HDEG [2-117](#)
 GAIN-HFAIL [2-117](#)
 GAIN-LDEG [2-117](#)
 GAIN-LFAIL [2-117](#)
 GBICs
 install [1-144](#)
 remove [1-144](#)
 replace [1-143](#)
 GCC-EOC [2-117](#)
 GE logical object [2-21](#)
 GE-OOSYNC [2-117](#)
 GFP
 encapsulation mismatch [2-81](#)
 FC_MR-4 congestion [2-101](#)
 GFP-CSF alarm [2-117](#)
 GFP-DE-MISMATCH alarm [2-118](#)
 GFP-EX-MISMATCH alarm [2-119](#)
 GFP-FAC logical object [2-21](#)
 GFP-LFD alarm [2-119](#)
 GFP-NO-BUFFERS alarm [2-120](#)
 GFP-UP-MISMATCH alarm [2-121](#)
 G-Series Ethernet cards
 carrier loss [2-63](#)
 clear loopbacks [2-278](#)
 facility loopback behavior [1-4](#)
 facility loopback condition [2-172](#)
 LED activity [2-260](#)
 LED test [1-109](#)
 terminal loopback behavior [1-6](#)

terminal loopback condition [2-177](#)
 terminal loopback PM behavior [1-7](#)
 transport layer failure alarm [2-249](#)
 troubleshoot Ethernet circuit paths [1-69](#)

H

hairpin circuit

definition [1-8](#)
 perform on a destination-node electrical port [1-33](#)
 perform on a destination-node Ethernet port [1-90](#)
 perform on a source-node Ethernet port [1-75](#)
 perform on source-node electrical port [1-15](#)

HELLO [2-121](#)

HIBATVG [2-122](#)

HI-CCVOLT [2-122](#)

HI-LASERBIAS [2-123](#)

HI-LASERTEMP [2-123](#)

HI-RXPOWER [2-124](#)

HITEMP [2-125](#)

HI-TXPOWER [2-126](#)

HLDOVRSYNC [1-137, 2-127](#)

I

idle signal condition [2-108](#)

I-HITEMP [2-128](#)

ILK-FAIL [2-128](#)

improper card removal [2-128](#)

IMPROPRMVL [2-128](#)

INC-ISD [2-130](#)

INCOMPATIBLE-SEND-PDIP [2-130](#)

INCOMPATIBLE-SW [1-128, 2-130](#)

INHSWPR [2-131](#)

INHSWWKG [2-131](#)

Internet Explorer, reset as default browser [1-121](#)

interoperability problems [1-128](#)

INTRUSION [3-7](#)

INTRUSION-PSWD [2-132](#)

INVMACADR [2-132](#)

IOSCFGCOPY [2-134](#)

IOSCFG-COPY-FAIL [3-7](#)

IP connectivity

IP address unknown [1-120](#)

no connectivity exists between nodes [1-129](#)

retrieve IP address [1-120](#)

verify [1-116, 1-119](#)

IP subnets [1-130](#)

ISC logical object [2-21](#)

ISIS-ADJ-FAIL [2-134](#)

J

Java

Jave Runtime Environment *see* JRE

browser does not launch [1-117](#)

Java plug-in control panel, reconfigure [1-117](#)

JRE

compatibility by software release [1-127](#)

incompatibility [1-127](#)

launch failure [1-117](#)

K

KB-PASSTHR [2-136](#)

KBYTE-APS-CHAN-FAIL [2-136](#)

k bytes

APS default K byte received [2-40](#)

APS node ID mismatch [2-44](#)

K bytes pass through [2-136](#)

test signal [2-42](#)

L

lamp test [1-108](#)

LAN (CAT-5) cable

- crimp [1-141](#)
- faulty [1-139](#)
- LAN-POL-REV [2-137](#)
- LASER-APR [2-137](#)
- LASERBIAS-DEG [2-137](#)
- LASERBIAS-FAIL [2-138](#)
- LASEREOL [2-138](#)
- LASERTEMP-DEG [2-138](#)
- LCAS
 - LCAS-CRC [2-138](#)
 - LCAS-RX-DNU [2-139](#)
 - LCAS-RX-FAIL [2-140](#)
 - LCAS-RX-GRP-ERR [2-141](#)
 - LCAS-TX-ADD [2-141](#)
 - LCAS-TX-DNU [2-141](#)
- LED
 - blinking STAT LED [1-138](#)
 - cross-connect card side switch [2-261](#)
 - lamp test [1-108](#)
 - traffic card after reset [2-260](#)
 - traffic card during reset [2-260](#)
 - traffic card insertion [2-260](#)
- line coding [2-148](#)
- line framing [2-148, 2-149, 2-151](#)
- line interface unit [1-3](#)
- LINK-KEEPALIVE [2-142](#)
- LKOUTPR-S [2-142](#)
- LMP
 - LMP-SD [2-144](#)
 - LMP-SF [2-145](#)
 - LMP-UNALLOC [2-146](#)
- LMP-FAIL [2-143](#)
- LMP-SD [2-144](#)
- LMP-SF [2-145](#)
- LMP-UNALLOC [2-146](#)
- LOA [2-147](#)
- lock initiation [2-262](#)
- lock-on *see* external switching commands
- LOCKOUT-REQ [2-147](#)
- lockout *see* external switching commands
- LOF
 - BITS [2-148](#)
 - DS1 [2-149](#)
 - DS3 [2-150](#)
 - E1 [2-150](#)
 - EC1 [2-151](#)
 - FE-LOF [2-109](#)
 - OCN [2-152](#)
 - OTUK-LOF [2-193](#)
 - STSTRM [2-152](#)
 - TRUNK [2-153](#)
 - TX-LOF [2-252](#)
- LOGBUFR90 [2-153](#)
- LOGBUFROVFL [2-153](#)
- logical objects
 - alarm index [2-23](#)
 - definition list [2-20](#)
- log-in errors
 - applet security restrictions [1-126](#)
 - browser login does not launch Java [1-117](#)
 - browser stalls when downloading .jar file [1-123](#)
 - no DCC connection [1-130](#)
 - no IP connectivity [1-129](#)
 - slow CTC operation [1-124](#)
 - username/password mismatch [1-129](#)
- LOGIN-FAILURE-LOCKOUT [3-8](#)
- LOGIN-FAILURE-ONALRDY [3-8](#)
- LOGIN-FAILURE-PSWD [3-8](#)
- LOGOUT-IDLE-USER [3-8](#)
- LO-LASERBIAS [2-154](#)
- LO-LASERTEMP [2-154](#)
- LOM [2-155](#)
- loopback
 - see also* cross-connect loopbacks
 - see also* facility loopback
 - see also* terminal loopback
- LOP
 - AUTOSW-LOP [2-53](#)

- LOP-P [2-155](#)
 - LOP-V [2-156](#)
 - LO-RXPOWER [2-157](#)
 - LOS
 - 2R [2-158](#)
 - BITS [2-158](#)
 - DS1 [2-159](#)
 - DS3 [2-160](#)
 - E1 [2-162](#)
 - EC1 [2-163](#)
 - ESCON [2-164](#)
 - FE-LOS [2-110](#)
 - FUDC [2-164](#)
 - ISC [2-165](#)
 - LOS-O [2-167](#)
 - LOS-P (OCH) [2-167](#)
 - LOS-P (OMS) [2-167](#)
 - LOS-P (OTS) [2-167](#)
 - LOS-P (TRUNK) [2-167](#)
 - MSUDC [2-165](#)
 - OCN [2-165](#)
 - OTS [2-167](#)
 - TRUNK [2-167](#)
 - loss of frame *see* LOF
 - loss of pointer *see* LOP
 - loss of signal *see* LOS
 - LO-TXPOWER [2-167](#)
 - LPBKCRS [2-168](#)
 - LPBKDS3FEAC [2-169](#)
 - LPBKDS3FEAC-CMD [2-169](#)
 - LPBKFACILITY
 - change alarm suppression defaults [2-33](#)
 - CE1000 [2-169](#)
 - CE100T [2-169](#)
 - DS1 [2-170](#)
 - DS3 [2-170](#)
 - E1 [2-171](#)
 - EC1 [2-171](#)
 - ESCON [2-172](#)
 - FC [2-172](#)
 - FCMR [2-172](#)
 - G1000 [2-172](#)
 - GE [2-173](#)
 - ISC [2-173](#)
 - OCN [2-173](#)
 - TRUNK [2-174](#)
 - LPBKTERMINAL
 - change alarm suppression defaults [2-33](#)
 - CE1000 [2-174](#)
 - CE100T [2-174](#)
 - CEMR [2-169, 2-174](#)
 - DS1 [2-175](#)
 - DS3 [2-175](#)
 - E1 [2-175](#)
 - EC1 [2-175](#)
 - ESCON [2-176](#)
 - FC [2-176](#)
 - FCMR [2-176](#)
 - G1000 [2-177](#)
 - GE [2-177](#)
 - ISC [2-177](#)
 - OCN [2-177](#)
 - TRUNK [2-178](#)
 - LWBATVG [2-178](#)
-
- ## M
- MAC address
 - CTC location [2-283](#)
 - invalid [2-132](#)
 - mismatch [1-132](#)
 - major alarms
 - definition [2-33](#)
 - list of alarms [2-3](#)
 - MAN-REQ [2-179](#)
 - MANRESET [2-179](#)
 - MANSWTOINT [2-179](#)
 - MANSWTOPRI [2-180](#)

MANSWTOSEC [2-180](#)
 MANSWTOTHIRD [2-180](#)
 MANUAL-REQ-RING [2-180](#)
 MANUAL-REQ-SPAN [2-181](#)
 MANWKSWBK-NO-TRFSW [3-8](#)
 MANWKSWPR-NO-TRFSW [3-8](#)
 MAX-STATIONS [2-181](#)
 MEA
 AIP [2-182](#)
 BIC [2-182](#)
 EQPT [2-183](#)
 FAN [2-185](#)
 PPM [2-186](#)
 SHELF [2-186](#)
 MEM-GONE [2-186](#)
 MEM-LOW [2-187](#)
 MFGMEM [2-187](#)
 minor alarms
 definition [2-33](#)
 list of alarms [2-4](#)
 ML1000
 logical object [2-21](#)
 see also ML-Series Ethernet cards
 ML100T
 logical object [2-21](#)
 see also ML-Series Ethernet cards
 MLFX
 logical object [2-21](#)
 see also ML-Series Ethernet cards
 MLMR logical object [2-21](#)
 ML-Series Ethernet cards
 see also LCAS
 C2 byte mismatched path [2-81](#)
 carrier loss [2-66](#)
 error in startup configuration [2-89](#)
 IOS configuration copy in progress condition [2-134](#)
 LED activity [2-260](#)
 transport layer failure alarm [2-250](#)
 verify LED operation [1-109](#)

MS-DEG [2-188](#)
 MS-EXC [2-188](#)
 MSUDC logical object [2-21](#)
 MT-OCHNC [2-188](#)

N

near-end alarms, hierarchy [2-34](#)
 NE logical object [2-21](#)
 NE-SREF logical object [2-21](#)
 Netscape Navigator
 clear cache [1-123](#)
 limit colors [1-121](#)
 unable to launch CTC help after removing browser [1-121](#)
 network testing
 see hairpin circuits
 see loopbacks
 NIC card [1-118, 1-132](#)
 NO-CONFIG [2-188](#)
 node ID, identify [2-261](#)
 NON-CISCO-PPM [2-189](#)
 not alarmed alarms
 definition [2-33](#)
 NOT-AUTHENTICATED [1-129, 2-189](#)
 not reported alarms
 definition [2-33](#)

O

OCH logical object [2-22](#)
 OCHNC-CONN logical object [2-22](#)
 OCHNC-INC [2-189](#)
 OCHTERM-INC [2-190](#)
 OCH-TERM logical object [2-22](#)
 OC-N cards
 bit errors [1-139](#)
 circuit state transition error [1-134](#)
 clear a cross-connect loopback circuit [2-277](#)

- clear a facility or terminal loopback circuit [2-276](#)
- create a cross-connect loopback [1-19](#)
- facility loopback behavior [1-4](#)
- hairpin circuits [1-8](#)
- LED activity [2-260](#)
- lockout request condition [2-148](#)
- loopback caveat [1-2](#)
- OC-3 and DCC limitations [1-137](#)
- reset [2-271](#)
- terminal loopback alarm [2-177](#)
- terminal loopback behavior [1-6](#)
- terminal loopback condition [2-177](#)
- test and clear a cross-connect loopback circuit [1-20](#)
- transmit and receive levels [1-145](#)

- OCN logical object [2-22](#)
- ODUK-1-AIS-PM [2-190](#)
- ODUK-2-AIS-PM [2-190](#)
- ODUK-3-AIS-PM [2-190](#)
- ODUK-4-AIS-PM [2-190](#)
- ODUK-AIS-PM [2-190](#)
- ODUK-BDI-PM [2-190](#)
- ODUK-LCK-PM [2-190](#)
- ODUK-OCI-PM [2-191](#)
- ODUK-SD-PM [2-191](#)
- ODUK-SF-PM [2-191](#)
- ODUK-TIM-PM [2-191](#)
- OMS logical object [2-22](#)
- OOU-TPT [2-191](#)
- OPEN-SLOT [2-191](#)
- optical transmit and receive levels [1-146](#)
- OPTNTWMIS [2-192](#)
- OPWR-HDEG [2-192](#)
- OPWR-HFAIL [2-192](#)
- OPWR-LDEG [2-192](#)
- OPWR-LFAIL [2-192](#)
- OSC-RING logical object [2-22](#)
- OSPF
 - DCN tool [1-113](#)
 - disable OSPF [2-276](#)

- HELLO alarm [2-121](#)
- OSRION [2-192](#)
- OTS logical object [2-22](#)
- OTUK-AIS [2-193](#)
- OTUK-BDI [2-193](#)
- OTUK-IAE [2-193](#)
- OTUK-LOF [2-193](#)
- OTUK-SD [2-193](#)
- OTUK-SF [2-193](#)
- OTUK-TIM [2-193](#)
- OUT-OF-SYNC [2-193](#)

P

- PARAM-MISM [2-194](#)
- password/username mismatch [1-129](#)
- path alarms, hierarchy [2-33](#)
- path protection
 - AIS alarm [2-52](#)
 - failed switch path [2-96](#)
 - initiate a Force switch [2-266](#)
 - initiate a Manual switch [2-266](#)
 - LOP alarm [2-53](#)
 - PDI alarm [2-54](#)
 - SD alarm [2-54](#)
 - signal failure alarm [2-55](#)
- PC requirements [1-115](#)
- PDI
 - AUTOSW-PDI [2-54](#)
 - PDI-P [2-194](#)
- PEER-NORESPONSE [2-195](#)
- ping [1-116](#), [1-119](#), [2-227](#)
- PLM
 - PLM-P [2-196](#)
 - PLM-V [2-197](#)
- PMI [2-197](#)
- PM-TCA [3-8](#)
- PORT-FAIL [2-198](#)
- PORT-MISMATCH [2-198](#)

power

- battery failure [2-56](#)
- extreme high voltage [2-80](#)
- extreme low voltage [2-81](#)
- high receive power [2-124](#)
- high transmit power [2-126](#)
- high voltage battery [2-122](#)
- improper power supply [1-149](#)
- low receive power [2-157](#)
- low transmit power [2-168](#)
- low voltage battery [2-178](#)
- measure power levels [2-84](#)
- power failure at connector [2-200, 2-201, 2-202](#)
- power monitoring mismatch [2-258](#)
- power supply problems [1-147](#)

PPM [2-62](#)PPM logical object [2-22](#)PRC-DUPID [2-199](#)PROTNA [2-199](#)PROV-MISMATCH [2-200](#)PS [3-9](#)PTIM [2-200](#)PWR-FAIL-A [2-200](#)PWR-FAIL-B [2-201](#)PWR-FAIL-RET-A [2-202](#)PWR-FAIL-RET-B [2-202](#)PWR logical object [2-22](#)

RRAI [2-203](#)RCVR-MISS [2-203](#)receive levels [1-145](#)RFI [2-205](#)ERFI-P-CONN [2-88](#)ERFI-P-PAYLD [2-88](#)ERFI-P-SRVR [2-88](#)RFI-L [2-205](#)RFI-P [2-205](#)RFI-V [2-206](#)RING-ID-MIS [2-207](#)RING-MISMATCH [2-208](#)RING-SW-EAST [2-208](#)RING-SW-WEST [2-208](#)RMON-ALARM [3-9](#)RMON-RESET [3-9](#)ROLL [2-209](#)ROLL-PEND [2-209](#)RPRIF logical object [2-22](#)RPR-PASSTHR [2-210](#)RPR-PEER-MISS [2-211](#)RPR-PROT-ACTIVE [2-212](#)RPR-PROT-CONFIG-MISM [2-213](#)RPR-RI-FAIL [2-213](#)RPR-SD [2-214](#)RPR-SF [2-215](#)RPR-SPAN-MISMATCH [2-215](#)RPRW [2-216](#)RSV-RT-EXCD-RINGLETO [2-204](#)RSV-RT-EXCD-RINGLETI [2-204](#)RUNCFG-SAVENEED [2-217](#)RX levels [1-146](#)RX packet [1-7](#)

Ssafety summary [2-36](#)SAN card *see* FC_MR-4 card

SD

AUTOSW-SDBER [2-54](#)DS1 [2-218](#)DS3 [2-218](#)E1 [2-219](#)ODUK-SD-PM [2-191](#)OTUK-SD [2-193](#)RPR-SD [2-214](#)SD-L [2-221](#)SD-L (trunk) [2-221](#)

- SD-P [2-221](#)
- SD-V [2-222](#)
- TRUNK [2-221](#)
- service-affecting alarms, definition [2-35](#)
- severities [2-33](#)
- SF
 - AUTOSW-SFBER [2-54](#)
 - DS1 [2-222](#)
 - DS3 [2-222](#)
 - E1 [2-223](#)
 - ODUK-SF-PM [2-191](#)
 - OTUK-SF [2-193](#)
 - RPR-SF [2-215](#)
 - SF-L [2-224](#)
 - SF-L (trunk) [2-224](#)
 - SF-P [2-225](#)
 - SF-V [2-226](#)
 - TRUNK [2-224](#)
- SFPs
 - install [1-144](#)
 - remove [1-144](#)
 - replace [1-143](#)
- SFTWDOWN [2-225](#)
- SFTWDOWN-FAIL [3-9](#)
- SHELF-COMM-FAIL [2-226](#)
- SHELF logical object [2-22](#)
- SH-IL-VAR-DEG-HIGH [2-226](#)
- SH-IL-VAR-DEG-LOW [2-226](#)
- SHUTTER-OPEN [2-226](#)
- side switch *see* external switching commands
- SIGLOSS [2-226](#)
- signal failure *see* SF
- SMB connector [2-203](#), [2-251](#)
- SNTP-HOST [2-227](#)
- SPANLEN-OUT-OF-RANGE [2-228](#)
- SPAN-SW-EAST [2-228](#)
- SPAN-SW-WEST [2-228](#)
- SQM [2-232](#)
- SQUELCH [2-228](#)
- SQUELCHED [2-230](#)
- SSM
 - do not use for synchronization [1-137](#)
 - failure [2-233](#)
 - quality level degrade [2-233](#)
 - SSM-DUS [2-232](#)
 - SSM-FAIL [2-233](#)
 - SSM-LNC [2-233](#)
 - SSM-OFF [2-234](#)
 - SSM-PRC [2-234](#)
 - SSM-PRS [2-234](#)
 - SSM-RES [2-234](#)
 - SSM-SDN-TN [2-235](#)
 - SSM-SETS [2-235](#)
 - SSM-SMC [2-235](#)
 - SSM-ST2 [2-235](#)
 - SSM-ST3 [2-235](#), [2-236](#)
 - SSM-ST4 [2-236](#)
 - SSM-STU [2-236](#)
 - SSM-TNC [2-237](#)
 - synchronization traceability alarm [2-236](#)
- storage access networking card *see* FC_MR-4 card
- STSMON
 - AUTOSW-LOP [2-53](#)
 - AUTOSW-UNEQ [2-55](#)
 - logical object [2-22](#)
- STS-SQUELCH-L [2-237](#)
- STSTRM logical object [2-22](#)
- switching
 - see* automatic protection switching
 - see* external switching commands
- SW-MISMATCH [2-237](#)
- SWMTXMOD-PROT [2-238](#)
- SWMTXMOD-WORK [2-239](#)
- SWTOPRI [2-239](#)
- SWTOSEC [2-240](#)
- SWTOTHIRD [2-240](#)
- SYNC-FREQ [2-240](#)
- synchronization status messaging *see* SSM

SYNCLOSS [2-241](#)

SYNCPRI [2-242](#)

SYNCSEC [2-242](#)

SYNCTHIRD [2-243](#)

SYSBOOT [2-244](#)

T

TCC2 card

communication failure (TCC2 to TCC2) [2-68, 2-69](#)

flash memory exceeded [2-77](#)

jar file download problem [1-123](#)

reseal (remove and reinsert) [2-273](#)

reset [2-271](#)

TCC2P card

communication failure (TCC2P to TCC2P) [2-68, 2-69](#)

flash memory exceeded [2-77](#)

jar file download problem [1-123](#)

reseal (remove and reinsert) [2-273](#)

reset [2-271](#)

TCP/IP [1-119, 2-61](#)

Telcordia

signal degrade definition [2-218](#)

signal failure definition [2-223](#)

temperature

fan-tray assembly alarm [2-100](#)

high-temperature alarm [2-125](#)

industrial high-temperature alarm [2-128](#)

OC-192 alarm [2-50](#)

TEMP-MISM [2-244](#)

terminal loopback

definition [1-5](#)

card view indicator [1-5](#)

clear an OC-N loopback circuit [2-276](#)

electrical card example [1-6](#)

perform on a destination electrical port [1-22](#)

perform on a destination-node Ethernet port [1-87](#)

perform on a destination-node FC_MR-4 card [1-105](#)

perform on a destination-node OC-N port [1-65](#)

perform on an intermediate-node Ethernet port [1-81](#)

perform on an intermediate-node FC_MR-4 card [1-101](#)

perform on an intermediate OC-N port [1-59](#)

perform on a source-node electrical port [1-40](#)

perform on a source node Ethernet port [1-71](#)

perform on a source-node FC_MR-4 card [1-96](#)

perform on a source-node OC-N port [1-50](#)

TIM

ODUK-TIM-PM [2-191](#)

OTUK-TIM [2-193](#)

PTIM [2-200](#)

TIM [2-245](#)

TIM-MON [2-246](#)

TIM-P [2-246](#)

TIM-S [2-247](#)

TIM-V [2-247](#)

timing alarms

64 clock bipolar density [2-58](#)

see also SSM

force switch to internal timing [2-114](#)

force switch to primary timing [2-115](#)

force switch to secondary timing [2-115](#)

force switch to tertiary timing [2-115](#)

free running synchronization [2-115](#)

loss of frame on BITS [2-148](#)

loss of primary reference [2-242](#)

loss of service on BITS [2-158](#)

loss of tertiary reference [2-243](#)

synchronization [2-127](#)

timing reference failure [2-116](#)

timing reference

automatic switch to secondary source (condition) [2-240](#)

automatic switch to third timing source (condition) [2-240](#)

change [2-129](#)

manual switch to internal source (condition) [2-179](#)

manual switch to primary source (condition) [2-180](#)

manual switch to second source (condition) [2-180](#)

manual switch to third source (condition) [2-180](#)
 switch error [1-137](#)
 TLINK logical object [2-23](#)
 TPTFAIL
 CE1000 [2-248](#)
 CE100T [2-248](#)
 CEMR [2-248](#)
 FCMR [2-248](#)
 G1000 [2-249](#)
 ML100T, ML1000, MLFX, MLMR [2-250](#)
 TPTFAIL (ML1000) [2-250](#)
 TPTFAIL (ML100T) [2-250](#)
 TPTFAIL (MLFX) [2-250](#)
 TPTFAIL (MLMR) [2-250](#)
 transient conditions
 transients are indexed individually by name
 alphabetical list [3-1](#)
 characteristics [3-3](#)
 states [3-4](#)
 transmission failure [2-251](#)
 transmit levels [1-145](#)
 TRMT [2-251](#)
 TRMT-MISS [2-251](#)
 troubleshooting
 see also alarm troubleshooting
 see also loopback
 alarm characteristics [2-32](#)
 conditions [2-32](#)
 frequently used procedures [2-261](#)
 service effect [2-35](#)
 severities [2-33](#)
 trouble notifications [2-32](#)
 TRUNK logical object [2-23](#)
 TX-AIS [2-251](#)
 Tx levels [1-146](#)
 TX-LOF [2-252, 2-255](#)
 Tx packet [1-7](#)
 TX-RAI [2-252](#)

U

UNC-WORD [2-253](#)
 UNEQ
 AUTOSW-UNEQ (STSMON) [2-55](#)
 AUTOSW-UNEQ (VTMON) [2-55](#)
 UNEQ-P [2-253](#)
 UNEQ-V [2-255](#)
 UNIX
 incorrect colors [1-121](#)
 reset the CTC_HEAP environmental variable [1-122](#)
 UNQUAL-PPM [2-255](#)
 untag [1-132](#)
 USER-LOCKOUT [3-9](#)
 USER-LOGIN [3-9](#)
 USER-LOGOUT [3-9](#)
 username/password mismatch [1-129](#)
 UT-COMM-FAIL [2-256](#)
 UT-FAIL [2-256](#)

V

VCG-DEG [2-256](#)
 VCG-DOWN [2-257](#)
 VCG logical object [2-23](#)
 VirusScan, disable [1-123](#)
 VLAN
 cannot connect to network device [1-132](#)
 change tagged and untag settings [1-133](#)
 VOA
 VOA-HDEG [2-257](#)
 VOA-HFAIL [2-257](#)
 VOA-LDEG [2-257](#)
 VOA-LFAIL [2-258](#)
 voltage *see* power
 VOLT-MISM [2-258](#)
 VT1.5 circuit creation error [1-136](#)
 VT-MON logical object [2-23](#)
 VT-TERM logical object [2-23](#)

W

warnings [2-36](#)

west or east misconnection alarm [2-90](#)

WKSWBK [3-10](#)

WKSWPR [2-258, 3-10](#)

workstation requirements [1-115](#)

WTR [2-259](#)

WTR-SPAN [3-10](#)

WVL-MISMATCH [2-260](#)

X

XFPs

install [1-144](#)

remove [1-144](#)

replace [1-143](#)