



Getting Started



Note

The terms "Unidirectional Path Switched Ring" and "UPSR" may appear in Cisco literature. These terms do not refer to using Cisco ONS 15xxx products in a unidirectional path switched ring configuration. Rather, these terms, as well as "Path Protected Mesh Network" and "PPMN," refer generally to Cisco's path protection feature, which may be used in any topological network configuration. Cisco does not recommend using its path protection feature in any particular topological network configuration.

Transaction Language 1 (TL1) is a subset of the input and output messages contained in the International Telecommunications Union (ITU) Man-Machine Language (MML). TL1 provides a standard set of messages that can be used for communicating between operating systems and network elements, and personnel and network elements. The ONS 15454 and ONS 15327 can support up to 20 concurrent TL1 sessions in this release. For more information about TL1, refer to Telcordia document GR-833-CORE, *Network Maintenance: Network Element and Transport Surveillance Messages*.

This chapter provides information and procedures for getting started with TL1:

- Setting up TL1 communication
- TL1 command syntax
- Autonomous messages
- TL1 commands by user security
- Provisioning a DS3E card in CTC using TL1
- Provisioning rules for MXP_2.5G_10G and TXP_MR_10G cards
- Provisioning rules for TXP_MR_2.5G and TXPP_MR_2.5G cards
- CTC interoperability
- Mixed mode timing support
- TL1 command completion behavior
- Test access
- TL1 PCA provisioning
- FTP software download

1.1 Setting up TL1 Communication

The period during which a user is logged into the ONS 15454 or ONS 15327 is called a session. There are three options you can use to open a session (login):

- Cisco Transport Controller (CTC)
- Telnet
- Craft interface

The TL1 password (PID) is masked when accessing a TL1 session using any of these options. When you logout of any of these options, you are closing a session. The ONS 15454 and ONS 15327 allow a maximum of 20 (19 telnet sessions and one craft session) concurrent TL1 sessions using any one or any combination of the options listed above. For information on issuing commands to multiple nodes, see [Chapter 2, “TL1 Gateway.”](#)

1.1.1 Open a TL1 session

Use the following procedures to open a TL1 session via the CTC, telnet, or craft interface. In the procedures the Activate and Cancel User commands are shown in their input format. For more information about these and other commands and messages, see [Chapter 3, “TL1 Command Descriptions.”](#)

Open a TL1 Session Via CTC

-
- Step 1** From the PC connected to the ONS 15454, start Netscape or Internet Explorer.
- Step 2** Enter the ONS 15454 IP address of the node you want to communicate with in the Netscape or Internet Explorer Web address (URL) field.
- Step 3** Log into the CTC. The IP address at the title bar should match the IP address of the node you entered in [Step 2](#).
- Step 4** Once logged into the CTC, click **Tools > Open TL1 Connection**.
- Step 5** Choose the node you want to communicate with from the Select Node dialog box.
- Step 6** Click **OK**.

A TL1 interface window opens. There are three sub-windows in the TL1 interface window: Request history, Message log, and TL1 request. Type commands in the TL1 request window. You will see responses in the Message log window. The Request history window allows you to recall previous commands by clicking on them.

- Step 7** Verify that the Connect button is selected (grayed out).
- Step 8** Type the Activate User command in the TL1 request window to open a TL1 session:
ACT-USER:[<TID>]:<UID>:<CTAG>::<PID>; and press **Enter**.



Note You must press Enter after the semicolon in each TL1 command, or the command will not be issued.

- Step 9** Type the Cancel User command in the TL1 request window or press the **Disconnect** button to close a TL1 session:

CANC-USER:[<TID>]:<USERID>:<CTAG>; and press **Enter**.

Open a TL1 Session Via Telnet

To access TL1 commands in a telnet session over a craft interface or a LAN connection (TCC+/TCC2 card front panel or backplane pins) you can choose from several ports. Port number 3082 is a raw TCP/IP port; it will not echo and it will not prompt the user. Port number 3083 is a telnet port that uses the telnet protocol and associated telnet escape sequences. Port number 2361 is supported for backward compatibility with earlier releases and has the same behavior as Port 3083 (telnet port). Use the following procedure with PCs running Windows operating systems.

Step 1 At the DOS prompt, type **cmd** and click **OK**. (The same steps can also be done from a Unix prompt).

Step 2 At the DOS command prompt type:

TELNET <NODE IP ADDRESS OR NODE NAME> <PORT NUMBER> and press **Enter**.

The Node IP address or Node Name refers to the IP address or Node Name of the node you want to communicate with. Port number is the port (2361, 3082, or 3083) where TL1 commands are understood. If the connection is successful, a screen opens with a prompt.

Step 3 Type the Activate User command to open a TL1 session:

ACT-USER:[<TID>]:<UID>:<CTAG>::<PID>;



Note When the semicolon is typed, the command is issued immediately.

Step 4 Type the Cancel User command to close a TL1 session:

CANC-USER:[<TID>]:<USERID>:<CTAG>;

Open a TL1 Session Via Craft Interface

The TCC+/TCC2 and XTC cards have two built-in interface ports for accessing the ONS 15454. With one RJ-45 LAN connection you can access the system using a standard browser interface. In the browser interface, you can perform local and remote Operations, Administration, Maintenance, and Provisioning (OAM&P) functions and open a VT100 emulation window to enter TL1 commands. If a browser is not available, you can access the system using a nine-pin RS-232 port. The RS-232 port supports VT100 emulation such that TL1 commands may be entered directly without a browser. For instructions on how to install the TL1 craft interface, refer to the *Cisco ONS 15454 Procedure Guide* or the *Cisco ONS 15327 Procedure Guide*.

Step 1 Connect the serial cable to the RS-232 port on the active TCC+/TCC2 or XTC card.

Step 2 Configure the terminal emulation software (Hyperterminal):

- a. Terminal emulation = vt100
- b. Bits per second = 9600
- c. Parity = None
- d. Stop BITS = 1

e. Flow control = None

Step 3 Press **Enter**. An angle bracket prompt (>) appears.

Step 4 At the > prompt, type the Activate User command to open a TL1 session:

```
ACT-USER:[<TID>]:<UID>:<CTAG>::<PID>;
```



Note When the semicolon is typed, the TL1 command is issued immediately.

Step 5 Type the Cancel User command to close a TL1 session:

```
CANC-USER:[<TID>]:<USERID>:<CTAG>;
```

1.2 TL1 Command Syntax

TL1 commands conform to the following syntax:

```
a:b:c:d:e: ... z;
```

where:

“a” is the command code

“b” is the target identifier (TID)

“c” is the access identifier (AID) or the user identifier (UID)

“d” is the correlation tag (CTAG)

“e: ... z;” are other positions required for various commands

The TID, AID, and CTAG route and control the TL1 command. Other parameters provide additional information required to complete the action requested by the command. TL1 command codes, parameter names and parameter values can be either uppercase or lowercase exclusively or any combination of the two, unless specifically noted in the command description.

The TID is a unique name given to each system when it is installed. The name identifies the particular NE (in this case, the ONS 15454 or ONS 15327), to which each command is directed. Each TID can have a maximum of 20 ASCII characters limited to letters, digits, and hyphens, but each TID must start with an alphabetic character. The presence of the TID is required in all input commands, but its value can be null (represented by two successive colons). The TID can be null when the operating system directly communicates with the target NE. The recommended value for the TID, when it is used, is the target’s CLI code. To establish the TID for an ONS 15454/15327 node, use the Provisioning > General tabs in CTC.



Note If the TID contains any characters other than letters and digits, such as spaces, the text string form (enclosed in double quotes) must be used.

The AID is an access code used to identify and address specific objects within the ONS 15454 and the ONS 15327. These objects include individual pieces of equipment, transport spans, access tributaries, and other objects.

The CTAG is a unique identifier given to each input command by the user. When the ONS 15454/ONS 15327 system responds to a specific command, it includes the command’s CTAG in the reply. Including the CTAG eliminates discrepancies about which response corresponds to which

command. Valid CTAG values include strings of up to six characters comprised of identifiers (alphanumeric, beginning with a letter) or decimal numerals (a string of decimal digits with an optional non-trailing ".").

The following specification characters are used throughout this document as vehicles for defining the syntax:

- < > enclose a symbol specifier, for example <CTAG>.
- [] enclose an optional symbol, for example [<TID>].
- “ ” enclose a literal character, for example an output format “SLOT-7:PLUGIN,TC,,,,,:\"EQUIPMENT PLUG-IN\",TCC”
- ^ is a space, a literal blank character used only in examples of messages.

1.3 Autonomous Messages

The autonomous TL1 messages are included in [Chapter 3, “TL1 Command Descriptions”](#) and listed alphabetically. [Figure 1-1](#) shows the autonomous message format. The autonomous message tag (ATAG) is used for message sequencing. The number is incremented by one for each autonomous message sent by the ONS 15454 or ONS 15327. The ONS 15454 and ONS 15327 use whole numbers 0000 to 9999.



Note

Some autonomous messages (REPT DBCHG and REPT EVT SESSION, for example) differ slightly from the format shown in the third line of [Figure 1-1](#).

Figure 1-1 Autonomous message format

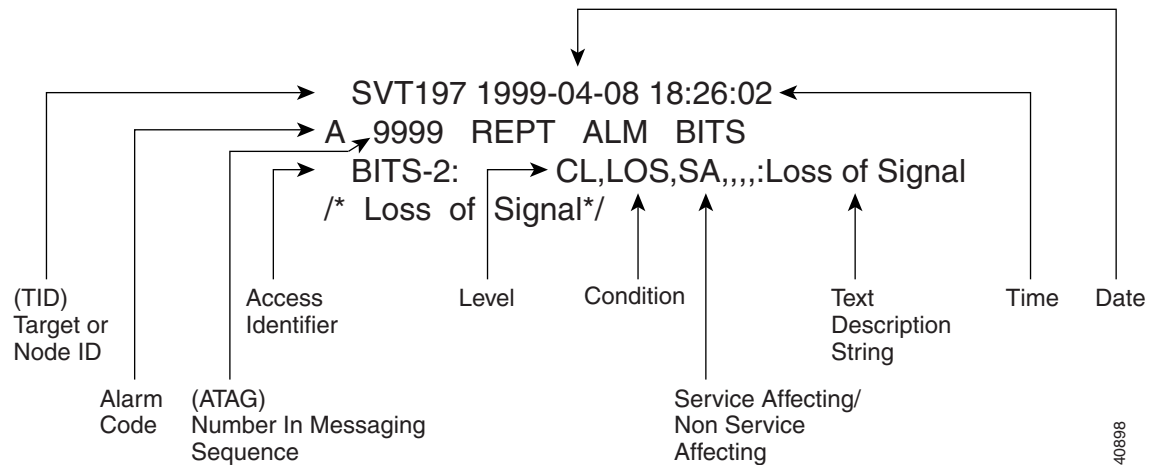

1.3.1 Alarm Codes

The alarm code indicates the severity of the autonomous message. Valid values for alarm codes in decreasing order of severity are as follows:

- *C Critical alarm
- ** Major alarm

- *^ Minor alarm
- A^ Non-alarm message

Critical, Major, and Minor correspond to the reporting of alarmed events. The Non-alarm message designation is used when the NE is reporting non-alarmed events, periodic measurements, or results of previously-scheduled diagnostics or audits. If multiple alarms are reported in the same message, the alarm code is the highest severity of those being reported.

The following is an example of an output message that includes the Critical alarm code:

```
AB7-56 1970-01-01 16:02:10
*C 100.100 REPT ALM EQPT
  "SYSTEM:CR,HITEMP,NSA,,,,:\“High Temperature\”,TCC”
```

For more information about alarms, see [Chapter 7, “TL1 Alarms and Errors.”](#)

1.4 TL1 Commands by User Security

The following table specifies command access privileges for each user security level.

Table 1-1 Command Access

Command	Superuser	Provisioning	Maintenance	Retrieve
ALW-MSG-SECU	X			
APPLY	X			
COPY-RFILE	X			
DLT-USER-SECU	X			
ED-DAT	X			
ED-USER-SECU	X			
ENT-USER-SECU	X			
INH-MSG-SECU	X			
REPT EVT SECU	X			
DLT-*_*	X	X		
ED-*_*	X	X		
ENT-*_*	X	X		
SET-*_*	X	X		
SET-TOD	X	X		
INIT-*_*	X	X	X	
OPR-*_*	X	X	X	
RLS-*_*	X	X	X	
RMV-*_*	X	X	X	
RST-*_*	X	X	X	
SW-*_*	X	X	X	
ACT-*_*	X	X	X	X
ALW-*_*	X	X	X	X

Table 1-1 *Command Access (continued)*

Command	Superuser	Provisioning	Maintenance	Retrieve
CANC-*_*	X	X	X	X
ED-PID	X	X	X	X
INH-*_*	X	X	X	X
REPT * * ¹	X	X	X	X
RTRV-*_*	X	X	X	X

1. Except for REPT EVT SECU which is Superuser only as shown above.

User security levels limit the amount of time a user can leave the system idle before the TL1 session is locked to prevent unauthorized users from making changes. Higher security levels have shorter time outs. Starting with Release 4.0, time outs can be provisioned (by a Superuser) from CTC. If provisioned, it only affects users who are not currently logged in. A user that is logged in has to log out and log back in before the new timeouts will take affect.

Table 1-2 shows security levels and their default time outs.

Table 1-2 *Security Default Time Outs*

Security Level	Default Timeouts
Retrieve	Unlimited
Maintenance	60 minutes
Provisioning	30 minutes
Superuser	15 minutes

1.5 Provisioning a DS3E Card in CTC Using TL1

The DS3E card can autosense the framing being received and set the framing accordingly; however, this framing autosense feature can only be set using CTC. Use CTC to set the FMT attribute on a DS3E card to autoprovision which results in the FMT field being blanked out for a few seconds while the DS3E card is determining the framing mode coming into that particular port. The FMT field is then set accordingly to unframed, M23, or CBit. If the DS3E card is not present (pre-provisioned), setting the FMT field to autoprovision will result in the FMT field defaulting to unframed.

The TL1 interface does not support the autoprovision option for the DS3E card; the TL1 interface only supports unframed, M23, or CBit. If autoprovision is selected from CTC and at the same time the TL1 command RTRV-T3 is issued, the TL1 output will result in the FMT field populated with unframed during the time period that the DS3E card (if present) is autosensing the frame format. If the DS3E card is not present (pre-provisioned), issuing RTRV-T3 after CTC sets the FMT to autoprovision will result in the TL1 output populating the FMT field with unframed.

1.6 Provisioning Rules for MXP_2.5G_10G and TXP_MR_10G Cards

The following sections provide rules necessary when performing provisioning with the MXP_2.5G_10G and TXP_MR_10G (MXP/TXP) cards.

1.6.1 Payload Provisioning Rules for MXP/TXP Cards

1. You are allowed to change payload type only if all ports are in OOS state.
2. If the slot is in regeneration group, changing payload type affects both cards.
3. Changing payload is a card-level operation (i.e. all client ports are affected).
4. There should be no DCC enable on any ports.
5. Only the TXP_MR_10G card can be used for 10GE payload.
6. To set the 10GE payload for a TXP_MR_10G card, the termination mode must be set to transparent.
7. The payload cannot be changed if any of the ports are a part of any Y cable protection group or are used as the timing source.
8. The TL1 commands to provision are:
 - ED-DWDM:[<TID>]:<AID>:<CTAG>:::[PEERID=<PEERID>],[NAME=<NAME>],¹
[TERMMODE=<TERMMODE>],[PAYLOAD=<PAYLOAD>],[PWL=<PWL>];
 - 1. [NAME=<NAME>] applies to R4.5 only.
 - RTRV-DWDM:[<TID>]:<AID>:<CTAG>;

1.6.2 Termination Mode Provisioning Rules for MXP/TXP Cards

1. Only applicable to payload type of SONET/SDH for MXP_2.5G_10G and TXP_MR_10G cards.
2. Changing termination mode is a card-level operation (i.e. client and trunk must have the same termination mode selection).
3. There should be no DCC enabled on any ports.
4. All ports need to be in OOS state.
5. For transparent termination mode, the trunk port should not be a timing source.
6. Section termination mode is not supported for both the MXP and TXP cards.
7. The trace mode should be set to OFF for the J0 Section trace level on all ports, prior to a change of the termination mode.
8. The TL1 commands to provision are:
 - ED-DWDM:[<TID>]:<AID>:<CTAG>:::[PEERID=<PEERID>],[NAME=<NAME>],¹
[TERMMODE=<TERMMODE>],[PAYLOAD=<PAYLOAD>],[PWL=<PWL>];
 - 1. [NAME=<NAME>] applies to R4.5 only.
 - RTRV-DWDM:[<TID>]:<AID>:<CTAG>;

1.6.3 Wavelength Provisioning Rules for MXP/TXP Cards

1. The DWDM (trunk) port should be placed in OOS state because this change is traffic affecting. This is enforced in CTC. TL1 does not enforce this restriction.
2. Setting the wavelength to the first tunable wavelength will cause the first wavelength from the card manufacturing data to be used as the operational wavelength.
3. If the provisioned wavelength is set to the first tunable wavelength, any removal of an operational card and the subsequent replacement with a card of a different wavelength will not cause a mismatch alarm to be raised.
4. In order to receive the mismatch alarm notification, you need to explicitly provision the wavelength and not use the first tunable wavelength.
5. The TL1 commands to provision are:
 - ED-DWDM:[<TID>]:<AID>:<CTAG>:::[PEERID=<PEERID>],[NAME=<NAME>],¹
[TERMMODE=<TERMMODE>],[PAYLOAD=<PAYLOAD>],[PWL=<PWL>];
1. [NAME=<NAME>] applies to R4.5 only.
 - RTRV-DWDM:[<TID>]:<AID>:<CTAG>;

1.6.4 DCC/GCC Provisioning Rules for MXP/TXP Cards

1. The DCC can be provisioned for the MXP and TXP cards.
2. The DCC can be provisioned only if the card payload is set to SONET/SDH and the termination mode is set to line terminated.
3. The client ports can only support DCC.
4. The trunk port can only support either DCC or GCC.
5. To enable the GCC on the trunk port, the G.709 should be enabled.
6. To enable the DCC on the trunk port, the G.709 should be disabled.
7. Only the working port (not the protect) in a Y cable protection scheme is allowed to be provisioned as DCC and timing reference.
8. The TL1 commands to provision are:
 - ED-CLNT:[<TID>]:<AID>:<CTAG>:::[NAME=<PORTNAME>],¹
[SFBER=<SFBER>],[SDBER=<SDBER>],[ALSMODE=<ALSMODE>],
[ALSRCINT=<ALSRCINT>],[ALSRCPW=<ALSRCPW>],[COMM=<COMM>],
[MACADDR=<MACADDR>],[SYNCSMSG=<SYNCSMSG>],
[SENDDUS=<SENDDUS>],[RLASER=<RLASER>],[SOAK=<SOAK>]:
[<PST>],[<SST>];
1. [NAME=<PORTNAME>] applies to R4.5 only.
 - ED-OCH:[<TID>]:<AID>:<CTAG>:::[RDIRN=<RDIRN>],
[EXPWLEN=<EXPWLEN>],[VOAATTN=<VOAATTN>],
[VOAPWR=<VOAPWR>],[CALOPWR=<CALOPWR>],
[CHPOWER=<CHPOWER>],¹[NAME=<PORTNAME>],¹[SFBER=<SFBER>],
[SDBER=<SDBER>],[ALSMODE=<ALSMODE>],[ALSRCINT=<ALSRCINT>],
[ALSRCPW=<ALSRCPW>],[COMM=<COMM>],[GCCRATE=<GCCRATE>],
[OSFBER=<OSFBER>],[OSDBER=<OSDBER>],[DWRAP=<DWRAP>],
[FEC=<FEC>],[MACADDR=<MACADDR>],[SYNCSMSG=<SYNCSMSG>],

```
[SENDDUS=<SENDDUS>],[RLASER=<RLASER>],[SOAK=<SOAK>]:
[<PST>],[<SST>];
```

1. [CHPOWER=<CHPOWER>] and [NAME=<PORTNAME>] apply to R4.5 only.

- RTRV-CLNT:[<TID>]:<AID>:<CTAG>;
- RTRV-OCH:[<TID>]:<AID>:<CTAG>;

1.6.5 G.709 Provisioning Rules for MXP/TXP Cards

1. The G.709 can only be provisioned on the trunk (DWDM) port.
2. In order to disable G.709, the FEC, if enabled, should be disabled first.
3. In order to disable G.709, the GCC if provisioned, should be removed.
4. In order to change G.709 setting, the trunk port needs to be OOS.
5. The TL1 commands to provision are:
 - ED-CLNT:[<TID>]:<AID>:<CTAG>:::[NAME=<PORTNAME>],¹
[SFBER=<SFBER>],[SDBER=<SDBER>],[ALSMODE=<ALSMODE>],
[ALSRCINT=<ALSRCINT>],[ALSRCPW=<ALSRCPW>],[COMM=<COMM>],
[MACADDR=<MACADDR>],[SYNCMSG=<SYNCMSG>],
[SENDDUS=<SENDDUS>],[RLASER=<RLASER>],[SOAK=<SOAK>]:
[<PST>],[<SST>];
1. [NAME=<PORTNAME>] applies to R4.5 only.
 - ED-OCH:[<TID>]:<AID>:<CTAG>:::[RDIRN=<RDIRN>],
[EXPWLEN=<EXPWLEN>],[VOAATTN=<VOAATTN>],
[VOAPWR=<VOAPWR>],[CALOPWR=<CALOPWR>],
[CHPOWER=<CHPOWER>],¹[NAME=<PORTNAME>],¹[SFBER=<SFBER>],
[SDBER=<SDBER>],[ALSMODE=<ALSMODE>],[ALSRCINT=<ALSRCINT>],
[ALSRCPW=<ALSRCPW>],[COMM=<COMM>],[GCCRATE=<GCCRATE>],
[OSFBER=<OSFBER>],[OSDBER=<OSDBER>],[DWRAP=<DWRAP>],
[FEC=<FEC>],[MACADDR=<MACADDR>],[SYNCMSG=<SYNCMSG>],
[SENDDUS=<SENDDUS>],[RLASER=<RLASER>],[SOAK=<SOAK>]:
[<PST>],[<SST>];
1. [CHPOWER=<CHPOWER>] and [NAME=<PORTNAME>] apply to R4.5 only.
 - RTRV-CLNT:[<TID>]:<AID>:<CTAG>;
 - RTRV-OCH:[<TID>]:<AID>:<CTAG>;

1.6.6 FEC Provisioning Rules for MXP/TXP Cards

1. The FEC can only be provisioned if the G.709 is enabled.
2. Trunk port needs to be OOS.
3. The TL1 commands to provision are:
 - ED-CLNT:[<TID>]:<AID>:<CTAG>:::[NAME=<PORTNAME>],¹
[SFBER=<SFBER>],[SDBER=<SDBER>],[ALSMODE=<ALSMODE>],
[ALSRCINT=<ALSRCINT>],[ALSRCPW=<ALSRCPW>],[COMM=<COMM>],
[MACADDR=<MACADDR>],[SYNCMSG=<SYNCMSG>],

```
[SENDUS=<SENDUS>],[RLASER=<RLASER>],[SOAK=<SOAK>]:
<PST>],[<SST>];
```

1. [NAME=<PORTNAME>.] applies to R4.5 only.

- ED-OCH:[<TID>]:<AID>:<CTAG>:::[RDIRN=<RDIRN>.]

```
[EXPWLEN=<EXPWLEN>],[VOAATTN=<VOAATTN>.]
[VOAPWR=<VOAPWR>],[CALOPWR=<CALOPWR>.]
[CHPOWER=<CHPOWER>.]1[NAME=<PORTNAME>.]1[SFBER=<SFBER>.]
[SDBER=<SDBER>],[ALSMODE=<ALSMODE>],[ALSRCINT=<ALSRCINT>.]
[ALSRCPW=<ALSRCPW>],[COMM=<COMM>],[GCCRATE=<GCCRATE>.]
[OSFBER=<OSFBER>],[OSDBER=<OSDBER>],[DWRAP=<DWRAP>.]
[FEC=<FEC>],[MACADDR=<MACADDR>],[SYNCMSG=<SYNCMSG>.]
[SENDUS=<SENDUS>],[RLASER=<RLASER>],[SOAK=<SOAK>]:
<PST>],[<SST>];
```

1. [CHPOWER=<CHPOWER>.] and [NAME=<PORTNAME>.] apply to R4.5 only.

- RTRV-CLNT:[<TID>]:<AID>:<CTAG>;
- RTRV-OCH:[<TID>]:<AID>:<CTAG>;

1.6.7 Synchronization Provisioning Rules for MXP/TXP Cards

1. Only the MXP card ports can be used for a timing source.
2. For the MXP card, all client ports are available for timing irrespective of the termination mode.
3. For the MXP card, the trunk port is only allowed for a timing reference if G.709 is off and the termination mode is set to line.
4. The TL1 commands to provision are:
 - ED-CLNT:[<TID>]:<AID>:<CTAG>:::[NAME=<PORTNAME>.]¹

```
[SFBER=<SFBER>],[SDBER=<SDBER>],[ALSMODE=<ALSMODE>.]
[ALSRCINT=<ALSRCINT>],[ALSRCPW=<ALSRCPW>],[COMM=<COMM>.]
[MACADDR=<MACADDR>],[SYNCMSG=<SYNCMSG>.]
[SENDUS=<SENDUS>],[RLASER=<RLASER>],[SOAK=<SOAK>]:
<PST>],[<SST>];
```

1. [NAME=<PORTNAME>.] applies to R4.5 only.
 - ED-OCH:[<TID>]:<AID>:<CTAG>:::[RDIRN=<RDIRN>.]

```
[EXPWLEN=<EXPWLEN>],[VOAATTN=<VOAATTN>.]
[VOAPWR=<VOAPWR>],[CALOPWR=<CALOPWR>.]
[CHPOWER=<CHPOWER>.]1[NAME=<PORTNAME>.]1[SFBER=<SFBER>.]
[SDBER=<SDBER>],[ALSMODE=<ALSMODE>],[ALSRCINT=<ALSRCINT>.]
[ALSRCPW=<ALSRCPW>],[COMM=<COMM>],[GCCRATE=<GCCRATE>.]
[OSFBER=<OSFBER>],[OSDBER=<OSDBER>],[DWRAP=<DWRAP>.]
[FEC=<FEC>],[MACADDR=<MACADDR>],[SYNCMSG=<SYNCMSG>.]
[SENDUS=<SENDUS>],[RLASER=<RLASER>],[SOAK=<SOAK>]:
<PST>],[<SST>];
```

1. [CHPOWER=<CHPOWER>.] and [NAME=<PORTNAME>.] apply to R4.5 only.
 - RTRV-CLNT:[<TID>]:<AID>:<CTAG>;
 - RTRV-OCH:[<TID>]:<AID>:<CTAG>;

1.6.8 Trace Provisioning Rules for MXP/TXP Cards

1. The client ports only support the SONET/SDH J0 section trace.
2. The client ports support the J0 Section trace only in line terminated mode.
3. The trunk (DWDM) port supports the J0 Section trace mode only in line terminated mode.
4. For the trunk port, if G.709 is enabled, TTI level trace can be provisioned for section and path monitoring.
5. In line termination, the J0 Section trace supports MANUAL and MANUAL_NO_AIS trace mode.
6. The J0 Section trace level supports 1 or 16-byte length trace format.
7. The OTN level trace supports only the Manual and MANUAL-NO-AIS trace modes.
8. The OTN level trace supports only 64-byte length trace format
9. The trace mode of AUTO and AUTO-NO-AIS are not supported.
10. The TL1 commands to provision are:
 - ED-TRC-CLNT:[<TID>]:<SRC>:<CTAG>:::[EXPTRC=<EXPTRC>],[TRC=<TRC>],[TRCMODE=<TRCMODE>],[TRCLEVEL=<TRCLEVEL>],[TRCFORMAT=<TRCFORMAT>][:];
 - ED-TRC-OCH:[<TID>]:<SRC>:<CTAG>:::[EXPTRC=<EXPTRC>],[TRC=<TRC>],[TRCMODE=<TRCMODE>],[TRCLEVEL=<TRCLEVEL>],[TRCFORMAT=<TRCFORMAT>][:];
 - RTRV-TRC-CLNT:[<TID>]:<SRC>:<CTAG>::[<MSGTYPE>],[<TRCLEVEL>][:];
 - RTRV-TRC-OCH:[<TID>]:<SRC>:<CTAG>::[<MSGTYPE>],[<TRCLEVEL>][:];

1.6.9 PM and Alarm Threshold Provisioning Rules for MXP/TXP Cards

1. The OTN thresholds are only applicable if the G.709 is enabled.
2. The FEC thresholds are only applicable if the G.709 and FEC are enabled.
3. The Optics TCA & Alarm Thresholds apply to the local node only.
4. The TL1 commands to provision are:
 - SET-TH-<MOD2>:[<TID>]:<AID>:<CTAG>::<MONTYPE>,<THLEV>,[<LOCN>],[<TMPER>];
 - RTRV-TH-<MOD2>:[<TID>]:<AID>:<CTAG>::[<MONTYPE>],[<LOCN>],[<TMPER>][:];

1.6.10 Regeneration Group Provisioning Rules for MXP/TXP Cards

1. Only a TXP card can be used in a regeneration group.
2. A regeneration group enables the continuation of the client signal across multiple spans.
3. Regeneration group rules are as follows:
 - a. peer-slot must not be itself
 - b. peer-slot must at least be preprovisioned
 - c. same card type

- d. same payload type
 - e. termination mode has to be set to transparent mode
 - f. peer slot cannot be part of another Y cable or regeneration group
4. Once two cards are in regeneration group, any payload changes will be reflected on both cards.
 5. The TL1 commands to provision are:
 - ED-DWDM:[<TID>]:<AID>:<CTAG>:::[PEERID=<PEERID>],[NAME=<NAME>],[¹TERMMODE=<TERMMODE>],[PAYLOAD=<PAYLOAD>],[PWL=<PWL>];
 - 1. [NAME=<NAME>] applies to R4.5 only.
 - RTRV-DWDM:[<TID>]:<AID>:<CTAG>;

1.6.11 Y Cable Protection Group Provisioning Rules for MXP/TXP Cards

1. A Y cable protection group can be created between the client ports of either two TXP cards or two MXP cards.
2. Y cable protection cannot be part of a regeneration group.
3. Only the working ports (not the protect) can be provisioned with DCC and timing reference.
4. The TL1 commands to provision are:
 - ENT-FFP-CLNT:[<TID>]:<WORKAID>,<PROTAID>:<CTAG>:::[PROTOTYPE=<PROTOTYPE>],[PROTID=<PROTID>],[RVRTV=<RVRTV>],[RVTM=<RVTM>],[PSDIRN=<PSDIRN>][:];
 - ED-FFP-CLNT:[<TID>]:<AID>:<CTAG>:::[PROTID=<PROTID>],[RVRTV=<RVRTV>],[RVTM=<RVTM>],[PSDIRN=<PSDIRN>][:];
 - RTRV-FFP-CLNT:[<TID>]:<AID>:<CTAG>[[:]];:

1.7 Provisioning Rules for TXP_MR_2.5G and TXPP_MR_2.5G Cards

The following sections provide rules necessary when performing provisioning with the TXP_MR_2.5G and TXPP_MR_2.5G cards.

1.7.1 Payload Provisioning Rules for TXP_MR_2.5G and TXPP_MR_2.5G Cards

1. Changing payload data type requires:
 - a. All ports must be in OOS state because the payload change is traffic-affecting.
 - b. All ports must not have any DCC termination.
 - c. All ports must not be part of any timing source.
 - d. All ports Section Trace Mode must be OFF>
 - e. For all 2R payload types trunk ports must not have GCC termination or OTN enabled.
 - f. If the card is part of a regeneration group, rules a. through d. also apply to the peer's ports.
 - g. If any port is Y cable protected rules a. through d. are applied to the peer's slot.

2. If the slot is in a regeneration group, changing payload type affects both cards.
3. Changing payload is a card-level operation (all client ports are affected).
4. To set the payload to other than OC3/OC12/OC48/STM1/STM4/STM16, the termination mode must be set to Transparent.

1.7.2 Termination Mode Provisioning Rules for TXP_MR_2.5G and TXPP_MR_2.5G Cards

1. Only applicable to payload type OC3/OC12/OC48/STM1/STM4/STM16.
2. Changing termination mode is a card level operation. Client and trunk must have the same termination mode selection.
3. Changing termination mode requires:
 - a. All ports must be in OOS state because termination mode change is traffic-affecting.
 - b. All ports must not have any DCC termination.
 - c. The Section Trace Mode on all ports must be OFF.
 - d. If any port is Y cable-protected rules a. through d. are applied to the peer's slot.
4. Section and Line termination mode is supported for payload OC3/OC12/OC48/STM1/STM4/STM16.

1.7.3 Wavelength Provisioning Rules for TXP_MR_2.5G and TXPP_MR_2.5G Cards

1. Changing trunk wavelength requires:
 - a. All trunk ports must be in OOS state because trunk wavelength change is traffic-affecting.
2. Setting the wavelength to the first tunable wavelength will cause the first wavelength from the card manufacturing data to be used as the operational wavelength.
3. If the provisioned wavelength is set to the first tunable wavelength any removal of an operational card and the subsequent replacement with a card for a different wavelength will not cause a mismatch alarm to be raised.
4. In order to receive the mismatch alarm notification you must explicitly provision the wavelength and not use the first tunable wavelength.

1.7.4 Regeneration Group Provisioning Rules for TXP_MR_2.5G and TXPP_MR_2.5G Cards

1. The TXP_MR_2.5G and TXPP_MR_2.5G cards can be used in a regeneration group.
2. When the TXPP_MR_2.5G card is used as a regeneration group, a LOCKOUT_OF_PROTECTION Inhibit Switching command on the working trunk port will be issued.
3. A user cannot unlock the Inhibit Switching command until the regeneration group is un-provisioned for the protect TXPP_MR_2.5G card.

4. Regeneration group provisioning will be denied if there is a FORCE or MANUAL switching command already provisioned on the trunk ports for the TXPP_MR_2.5G card.
5. A Regeneration group enables the continuation of the client signal across multiple spans.
6. Provisioning a regeneration group requires:
 - a. Peer-slot must not be itself.
 - b. Peer-slot must at least be preprovisioned.
 - c. Peer-slot must not be part of another regeneration group.
 - d. Peer-slot must not be part of a Y Cable protection group.
 - e. Same card type
 - f. Same payload type and data rate
 - g. Same G.709 OTN status
 - h. Same FEC status
 - i. Termination mode has to be set to Transparent mode
7. Once two cards are in regeneration group:
 - a. Any payload data type changes will be reflected on both cards.
 - b. Any changes for G.709 OTN and FEC status will be reflected on both cards.

1.7.5 DCC/GCC Provisioning Rules for TXP_MR_2.5G and TXPP_MR_2.5G Cards

1. SDCC can be provisioned on the client port.
2. All 2R payload types do not support GCC.
3. Provisioning an SDCC requires:
 - a. Payload Data Type is set to OC3/OC12/OC48/STM1/STM4/STM16 (or SONET/SDH framing type).
 - b. Termination mode is set to Line/Section terminated.
4. DCC can be provisioned on the trunk line provided that G.709 OTN status is turned off:
 - a. To provision a GCC on the trunk port, the G.709 should be enabled.
 - b. To provision a SDCC on the trunk port, the G.709 should be disabled.
5. Only the working client port in a Y Cable protection scheme is allowed to be provisioned with SDCC.
6. Only the working trunk port in a splitter protection scheme can be provisioned with SDCC or GCC.

1.7.6 G.709 OTN, FEC, and OTN SD/SDBER Provisioning Rules for TXP_MR_2.5G and TXPP_MR_2.5G Cards

1. The G.709 OTN, FEC, and OTN SD/SFBER can only be provisioned on the trunk port.
2. All 2R payload types do not support G.709 OTN or FEC.
3. To enable the G.709 OTN status:
 - a. All trunk ports must be in OOS state.

- b. All trunk ports must not have any SDCC provisioned.
4. In order to disable G.709:
 - a. All trunk ports must be in OOS state.
 - b. All trunk ports must not have any GCC or active TTI mode provisioned.
5. FEC status cannot be enabled if G.709 is not enabled.
6. To change FEC status all trunk ports must be in OOS state.
7. Only G.709 OTN, FEC status, SD/SFBER setting on the working trunk port can be changed in the TXPP_MR_2.5G card. The value provisioned on the working trunk port will be reflected on the protect trunk port.
8. G.709 OTN pane is only provisionable in non-2R (or unframed) payload type.
9. When G.709 is turned on OTN SFBER value is always set to 1E-5 and no other BER values are provisionable.

1.7.7 Synchronization Provisioning Rules for TXP_MR_2.5G and TXPP_MR_2.5G Cards

1. The TXP_MR_2.5G and TXPP_MR_2.5G cards are through-timed and cannot be used for a timing source.

1.7.8 Section Trace Provisioning (J0) Rules for TXP_MR_2.5G and TXPP_MR_2.5G Cards

1. The client and the trunk ports only support the section trace if the payload is OC3/OC12/OC48/STM1/STM4/STM16.
2. The client and trunk ports support the section trace only in Line/Section terminated mode.
3. In Line Termination mode, the supported trace modes are MANUAL and MANUAL_NO_AIS trace modes.
4. In Section Termination mode, the supported trace mode is only MANUAL_NO_AIS trace mode.
5. The Section trace supports 1 or 16 bytes length trace format.
6. The trace mode of AUTO and AUTO-NO-AIS are not supported.
7. No trace is applicable for 2R (or unframed) payload types, for example; DV-6000, HDTV, and ESCON.
8. The Section trace received string should be displayed when the card is in transparent termination mode and the payload is OC3/OC12/OC48/STM1/STM4/STM16.
9. When the client port is configured in a Y cable protection group the received string is always retrieved from the active client port.
10. If the line is Y cable protected trace can only be provisioned on the working, however; the provisioning will be duplicated between the two ports. Both ports will contain the same values. This rule applies to these parameters: Mode, Format, Send String, and Expected String.

1.7.9 Trail Trace Identification Provisioning (TTI) Rules for TXP_MR_2.5G and TXPP_MR_2.5G Cards

1. For the TXPP_MR_2.5G card TTI can be provisioned on both the working trunk ports only, however: the provisioning will be duplicated between two ports. Both ports will contain the same values. This rule applies to these parameters: Mode, Format, Send String, and Expected String.
2. The TTI level trace supports only 64 byte length trace format.
3. The TTI level trace supports only the MANUAL and MANUAL_NO_AIS trace modes.
4. The TTI level trace can be provisioned for the section and path monitoring.

1.7.10 PM and Alarm Threshold Provisioning Rules for TXP_MR_2.5G and TXPP_MR_2.5G Cards

1. When framing type is UNFRAMED, for example; HDTV or DV6000:
 - a. Only optics threshold provisioning and PM are applicable.
 - b. ESCON SFP does not support optics threshold provisioning and PM.
2. Optics PM supports only Near End, 15Min, and 1Day interval buckets.
3. When framing type is FIBER CHANNEL and ETHERNET, for example; 1GFC and 1G Ethernet:
 - a. Only 8B10B threshold provisioning and PM are available.
 - b. 2G Fiber Channel does not support 8B10B threshold provisioning and PM.
4. 8B10B applies to both Tx and Rx directions.
5. 8B10B PM supports only Near End, 15Min and 1Day interval buckets.
6. When framing type is SONET/SDH all monitored PM parameter terminology will follow the current chassis type.
7. The OTN thresholds are only applicable if G.709 OTN status is enabled.
8. The FEC thresholds are only applicable if the G.709 and FEC are enabled.
9. If the line is configured in a Y cable or Splitter protection group, only the working line thresholds can be provisioned. The working line thresholds will be reflected on the protect line thresholds. This rule applies for all threshold types including G.709 OTN and FEC thresholds.
10. Payload PM can be independently retrieved for both the working and protect port.

1.7.11 Y Cable Protection Group Provisioning Rules for TXP_MR_2.5G and TXPP_MR_2.5G Cards

1. A Y cable protection group can be created between the client ports of two TXP_MR_2.5G cards only.
2. While in Y cable protection, a TXP_MR_2.5G/TXPP_MR_2.5G card cannot be part of a regeneration group.
3. Only the working client port can be provisioned with SDCC.
4. Y cable cannot be provisioned for the TXPP_MR_2.5G card.

1.7.12 Loopback Provisioning Rules for TXP_MR_2.5G and TXPP_MR_2.5G Cards

1. Loopback can be provisioned on the client and trunk ports.
2. Both Terminal and Facility loopback types can be provisioned.
3. Loopback is not applicable when framing type is UNFRAMED.
4. For the TXPP_MR_2.5G card, the following loopback rules apply to the trunk ports:
 - a. Only one loopback is allowed to be provisioned at the trunk ports at any given time.
 - b. Loopback is allowed if the sibling trunk port is not IS.
 - c. Provisioning a loopback on a trunk port will trigger the Inhibit Switching command LOCKOUT_OF_PROTECTION or LOCKOUT_OF_WORKING depending on whether the working or the protect is placed in a loopback.
 - d. Once a loopback is provisioned on a trunk port both the trunk ports will transmit the signal of the loopback port.
 - e. Loopback will be denied if there is a FORCE or MANUAL switching command in place on the trunk ports.
 - f. You cannot remove the Inhibit Switching command issued as a result of the loopback. This Inhibit Switching command will be removed only when the loopback is removed.

1.7.13 ALS Provisioning Rules for TXP_MR_2.5G and TXPP_MR_2.5G Cards

1. ALS can be provisioned on the client and trunk ports.
2. If the trunk port is configured in a Splitter protection group, only the working trunk port can be provisioned for ALS, however; ALS provisioning on the working trunk port will be reflected on the protect port.
3. For the protected TXPP_MR_2.5G card, ALS mode will only take effect when both ports receive LOS.

1.7.14 Port State Model Provisioning Rules for TXP_MR_2.5G and TXPP_MR_2.5G Cards

1. The Enhanced state model port state of primary state=OOS and secondary state=AINS is not supported for the 1GigE/2GigE payload type.
2. The working and protect port can be put in IS/OOS independently.
3. For the TXPP_MR_2.5G card:
 - a. Setting the protect trunk port to OOS will enable the suppression of alarms on that port and will enable the card to be used like an unprotected card but the card still cannot be used for a Y cable protection group.
 - b. Setting the protect trunk port to OOS will not switch off the transmit laser unless both trunk ports are OOS.
 - c. The protect trunk port cannot be IS if there is a loopback or a regeneration group provisioned.

1.7.15 SONET-Related Provisioning Rules for TXP_MR_2.5G and TXPP_MR_2.5G Cards

1. The SD/SFBER can only be provisioned on the working trunk port for the TXPP_MR_2.5G card. Values set at the working port will be reflected on the trunk port.

1.7.16 Overhead Circuit Rules for TXP_MR_2.5G and TXPP_MR_2.5G Cards

1. LOW/EOW is possible between the AIC-I, OCn and TXP/MXP cards in any combination in line-terminated mode.
2. F1/D4-D12 UDC:
 - a. Not possible between TXP/TXPP and AIC-I cards in line-terminated mode.
 - b. Not possible between TXP/TXPP and OCn cards in line-terminated mode.
 - c. Possible between OCn ports.
3. All OH bytes are passed across client and DWDM ports in transparent mode.
4. SDCC/LDCC tunneling is not possible in line-terminated mode.
5. No end-to-end OH circuit provisioning. In R4.1/4.5 you can stitch them at each node.

1.7.17 Hardware Limitation Rules for TXP_MR_2.5G and TXPP_MR_2.5G Cards

1. ESCON SFP does not support any monitoring.
2. Optics thresholds and PM are not shown on client ports.
3. HI/LO-TXPOWER is not supported for TXP_MR_2.5G and TXPP_MR_2.5G Cards.

1.8 CTC Interoperability

A TL1 cross-connect that has been upgraded to a CTC circuit can no longer be managed by TL1. For example, if you issue a `DLT-CRS-<STS_PATH>` command to delete a circuit, you will see that the circuit still appears in CTC as “incomplete.” The reason for this is because in addition to creating cross-connects (as TL1 does), CTC creates another object on the source node that stores network-level circuit attributes. CTC will continue to see that object after the cross-connect is deleted which is why it shows an incomplete circuit.

Starting with R3.4, there is a *Create cross connects only (TL1-like)* check box that appears in CTC when creating circuits. If applicable, you can check this box to create one or more cross-connects to complete a signal path for TL1-generated circuits. If this box is checked, you cannot assign a name to the circuit; and VT tunnels, Ethergroup sources, and drops are unavailable. Refer to the *Cisco ONS 15454 Procedure Guide* or the *Cisco ONS 15327 Procedure Guide* for information about CTC circuit creation.

1.9 Mixed Mode Timing Support

Although TL1 supports mixed mode timing in R4.1 and R4.5, Cisco strongly advises against its implementation. Mixed mode timing is not a recommended timing mode because of the inherent risk of creating timing loops. Refer to Telcordia document GR-436-CORE, *Digital Network Synchronization Plan* for recommended synchronization planning. Refer to the *Cisco ONS 15454 Procedure Guide* or the *Cisco ONS 15327 User Documentation* for information about setting up ONS 15454/15327 timing. For further assistance contact the Cisco Technical Assistance Center (TAC) at www.cisco.com or call (800) 553-2447 for unresolved problems.

1.10 TL1 Command Completion Behavior

When you enter a TL1 command, one of three completion codes will be returned. The completion codes are: completed (COMPLD), partial (PRTL), and deny (DENY). You can specify an explicit, implicit, or explicit with implicit list as explained in the following sections.

1.10.1 General Rules



Note

The command completion behavior does not apply to RTRV-CRS, RTRV-ALM, and RTVR-COND commands.

1.10.1.1 Explicit List of AIDs - No Wildcards

If a set of AIDs is explicitly listed, including a set of just one AID, then each AID must complete successfully to return a COMPLD message. If more than one AID is in the set and at least one AID succeeds but all do not, then a PRTL with errors for each failed AID is returned. If all AIDs in the set fail, a DENY with errors for each failed AID is returned.

```
SLOT-1
FAC-2-1&FAC-3-3&FAC-4-2
```

1.10.1.2 Implicit List of AIDs - Single AID With Wildcard

If a set of AIDs is implied by the use of the ALL modifier on a single AID, then follow the same rules as in the [“Explicit List of AIDs - No Wildcards”](#) section on page 1-20. The caveat is that the implicit list only includes AIDs that apply to the command:

```
SLOT-ALL
FAC-1-ALL
STS-3-ALL
```

where Slot 3 contains an OC-12 and the command is ED-STSS1 but STS-3-4 and STS-3-7 are STS3C. The set implied by STS-3-ALL then only contains STS-3- $\{1,2,3,10,11,12\}$ and will not return an error for STS-3- $\{4,5,6,7,8,9\}$. Disregard the STS3C in this case because the modifier of the command specifies that the user is only interested in STS-1 paths. The rule specified in this section then applies to the implicit set of $\{1,2,3,10,11,12\}$.

1.10.1.3 Explicit List Grouped With Implicit List

If the set of AIDs is comprised of two subsets, one set including explicitly stated AIDs and the other set implied by one or more AID(s) with the ALL modifier, then follow the rules of the [“Explicit List of AIDs - No Wildcards” section on page 1-20](#) and the [“Implicit List of AIDs - Single AID With Wildcard” section on page 1-20](#), respectively.

```
FAC-1-1&FAC-2-ALL
FAC-3-ALL&FAC-7-ALL
STS-2-ALL&STS-12-1&STS-13-2&STS-14-ALL
```

1.10.2 Command Completion Behavior for Retrieval of Cross-Connections

When you enter a RTRV-CRS command, one of three completion codes will be returned. The completion codes are: completed (COMPLD), partial (PRTL), and deny (DENY). You can specify an explicit, implicit, or explicit with implicit list as explained in the following sections.

1.10.2.1 Explicit List of AIDs - No Wildcards

For an explicit list of AIDs on a RTRV-CRS command, an error code will be returned for each AID that fails validation (e.g. the user specifies STS-N-13 when SLOT-N only contains an OC-12) or for each AID where no matching cross-connection is found. To determine the completion code, follow the rules from the [“Explicit List of AIDs - No Wildcards” section on page 1-20](#). If the result is either PRTL or COMPLD, then a list of matching cross-connections will accompany the response.

1.10.2.2 Implicit List of AIDs - Single AID With Wildcard

If a set of AIDs is implied by the use of the ALL modifier on a single AID, then follow the same AID expansion rule as defined in the example from the [“Implicit List of AIDs - Single AID With Wildcard” section on page 1-20](#). Then apply the following rules to the set:

1. If all valid AIDs match, COMPLD is returned with a matching list of cross-connections.
2. If some valid AIDs match but not all, COMPLD is returned with a matching list of cross-connections.
3. If all valid AIDs fail to match, DENY is returned.

RTRV-CRS-STs1:[<TID>]:STS-9-ALL:<CTAG>; where STS-9-ALL maps to STS-9-{1,2,3,10,11,12} because there is a single-port OC-12 card in Slot 3 with STS-3C defined for STS-9-4 and STS-9-7. You then traverse the set and return only the STS1 cross-connections that exist using end points in that set. If no cross-connections are retrieved, COMPLD is returned.

1.10.2.3 Explicit List Grouped With Implicit List

When you have determined the implicit list, apply the rules from the [“Implicit List of AIDs - Single AID With Wildcard” section on page 1-21](#) to the implicit list and the rules from the [“Explicit List of AIDs - No Wildcards” section on page 1-21](#) to the explicit list. Apply the following logic to the results from the two subsets:

1. Explicit list returns COMPLD, implicit list returns COMPLD, return COMPLD plus matching list
2. Explicit list returns COMPLD, implicit list returns DENY, return PRTL with errors plus matching list

3. Explicit list returns PRTL, implicit list returns COMPLD, return PRTL with errors plus matching lists
4. Explicit list returns PRTL, implicit list returns DENY, return PRTL with errors plus matching list
5. Explicit list returns DENY, implicit list returns COMPLD, return PRTL with errors plus matching list
6. Explicit list returns DENY, implicit list returns DENY, return DENY with errors

1.11 Test Access

The test access (TACC) feature allows a third-party Broadband Remote Test Unit (BRTU) to create non-intrusive test access points (TAPs) to monitor the circuits on the ONS 15454/15327 for errors. The test access feature also allows the circuit to be split (intrusive), so that the transmission paths can be tested for bit errors via the use of various bit test patterns. The two BRTUs supported by the ONS 15454/15327 are the Hekimian/Spirent BRTU-93 (6750) and the TTC/Acterna Centest 650.

The test access functionality provides TL1 commands for creating and deleting TAPs, connecting or disconnecting TAPs to circuit cross-connects and changing the mode of test access on the ONS 15454/15327. You can view test access information in CTC; in node view click the **Maintenance > Test Access** tabs.

Refer to Telcordia document GR-834-CORE, *Network Maintenance: Access and Testing* and GR-1402-CORE, *Network Maintenance: Access Testing - DS3 HCDS TSC/RTU and DTAU Functional Requirements* for more information about Test Access. See [Chapter 3, “TL1 Command Descriptions”](#) for TL1 command information.

A TAP provides the capability of connecting the circuit under test to a BRTU. This connection initially provides in-service monitoring capability to permit the tester to determine that the circuit under test is idle. The monitor connection should not disturb the circuit under test. The access point and remote test unit (RTU) also provide the capability of splitting a circuit under test. A split consists of breaking the transmission path of the circuit under test. This is done out of service. The two sides of the access point are called the Equipment (E) and Facility (F) directions. For a 4-wire or 6-wire circuit, the transmission pairs within the access point are defined as the A and B pairs. The circuit under test should be wired into the access point so the direction of transmission on the A pair is from E to F, and the transmission direction for the B pair is from F to E ([Figure 1-2](#)).

Figure 1-2 *Circuit with no access*

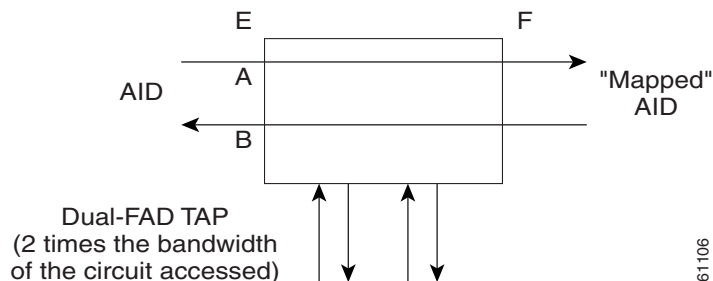

1.11.1 Test Access Terminology

BRTU—Broadband remote test unit
 DFAD—Dual facility access digroup
 FAD—Facility access digroup
 FAP—Facility access path
 MONE—Monitor access with signal detector on A path
 MONF—Monitor access with signal detector on B path
 MONEF—Monitor access with signal detector on A and B paths
 SPLTA—Split access on A path with signal detector from equipment, QRS on facility side
 SPLTB—Split access on B path with signal detector from equipment, QRS on equipment side
 SPLTE—Split access on A and B paths with signal detector from equipment, QRS on equipment side
 SPLTF—Split access on A and B paths with signal detector from equipment, QRS on facility side
 SPLTEF—Split access on A and B paths for testing in both equipment and facility directions
 LOOPE—Split/loop access on A and B paths equipment side
 LOOPF—Split/loop access on A and B paths facility side
 QRS—Quasi-random signal (bit test pattern)
 TACC—Test access
 TAP—Test access path/point
 Path Naming Conventions:
 E—Equipment test access point direction
 F—Facility test access point direction
 A—Transmission path (the direction of transmission on the A pair is from E to F)
 B—Transmission path (the transmission direction for the B pair is from F to E)

1.11.2 TAP Creation and Deletion

The edit command (ED-<rr>) is used to change an existing port, STS, or VT to a TAP.

Input Format:

```
ED-(STS_PATH):[<TID>]:<AID>:<CTAG>:::[SFBER=<SFBER>],[SDBER=<SDBER>],
[RVRTV=<RVRTV>],[RVTM=<RVTM>],[SWPDIP=<SWPDIP>],[EXPTRC=<EXPTRC>],
[TRC=<TRC>],[TRCMODE=<TRCMODE>],[TACC=<TACC>]:[<PST>],[<SST>];
```

Edit an existing port, STS, or VT and change it to a TAP so it can be used when requesting TACC connections. Includes a new optical parameter TACC=n that defines the port, STS, or VT as a TAP with a selected unique TAP number. This TAP number will be used when requesting test access connections to circuit cross-connections under test. The TAP creation will fail if there is a cross-connection already on the port, STS, or VT.

The following list applies to TAP numbers:

1. The TAP number is an integer within the range of 1–999. When TACC=0 is specified, the TAP is deleted (if already present).

2. The TAP number is unique across T1/T3/STS/VT/DS1 TAPs in the system.
3. The TAP number is not editable.

1.11.2.1 ED-T1

When the ED-T1 command is issued with a specified TACC value for a given T1 port/facility, a dual facility access group (DFAD) is created by using the specified port/facility and the consecutive port/facility.

Example 1-1 *ED-T1::FAC-1-1:12::TACC=1;*

```
DV9-99 1970-01-02 03:16:11
M 12 COMPLD
;
```

This command creates a DFAD on FAC-1-1 and FAC-1-2.



Note

These ports/facilities cannot be used for the creation of cross-connects until the TAP is deleted.

1.11.2.2 ED-T3

When the ED-T3 command is issued with a specified TACC value for a given T3 port/facility, a DFAD is created by using the specified port/facility and the consecutive port/facility.

The command in [Example 1-2](#) creates a T3 DFAD on FAC-2-1 and FAC-2-2.

Example 1-2 *ED-T3::FAC-2-1:12::TACC=2;*

```
DV9-99 1970-01-02 03:16:11
M 12 COMPLD
;
```



Note

These ports/facilities cannot be used for the creation of cross-connects until the TAP is deleted.

1.11.2.3 ED-DS1

When the ED-DS1 command is issued with a specified TACC value for a given DS1 facility on a DS3XM, a DFAD is created by using the specified facility and the consecutive port/facility.

The command in [Example 1-3](#) creates DFAD on DS1-2-1-1 and DS1-2-1-2.

Example 1-3 *ED-DS1::DS1-2-1-1:12::TACC=3;*

```
DV9-99 1970-01-02 03:16:11
M 12 COMPLD
;
```



Note

These ports/facilities cannot be used for the creation of cross-connects until the TAP is deleted.

1.11.2.4 ED-STSn

When the ED-STSn command is issued for a TACC it assigns the STS for the first 2-way test access connection and STS+1 as the second 2-way connection. For STS3c, STS9c, STS12c, STS24c, and STS48c the next consecutive STS of same width is chosen. The TAP creation will fail if either of the consecutive STSs are not available.

The command in [Example 1-4](#) creates a TAP on STS-5-1 and STS-5-2.

Example 1-4 *ED-STSn::STS-5-1:12::TACC=4*

```
DV9-99 1970-01-02 03:16:11
M 12 COMPLD
;
```

Note

These STSs cannot be used for the creation of cross-connects until the TAP is deleted.

The command in [Example 1-5](#) creates an STS24C dual TAP on STS-6-1 and STS-6-25.

Example 1-5 *ED-STSn::STS-6-1:12::TACC=5:*

```
DV9-99 1970-01-02 03:16:11
M 12 COMPLD
;
```

Note

These STSs cannot be used for the creation of cross-connects until the TAP is deleted.

1.11.2.5 ED-VT1

When the ED-VT1 command is issued for a TACC, a VT TAP is created. The specified VT AID is taken as the first VT connection, the second VT connection is made by incrementing the VT group and keeping the VT number the same.

The command in [Example 1-6](#) creates a VT TAP on VT1-1-1-1-1 and VT1-1-1-2-1.

Example 1-6 *ED-VT1-1-1-1-1:12::TACC=6;*

```
DV9-99 1970-01-02 03:16:11
M 12 COMPLD
;
```

Note

These VTs cannot be used for the creation of cross-connects until the TAP is deleted.

1.11.3 Connect Test Access Points

The CONN-TACC command (CONN-TACC-<rr>) is used to make a connection between the TAP and the circuit or cross-connect under test.

Input Format: CONN-TACC-(T1, T3, STS1, STS3C, STS6C, STS9C, STS12C, STS24C, STS48C, VT1, DS1):[<TID>]:<AID>:<CTAG>::<TAP>:MD=<MD>;

Connect the port/STS/VT defined by <AID> to the port/STS/VT defined by the <TAP> number. The mode of test access to the circuit/cross-connect is specified by <MD>. The modes can be either of monitor (non-intrusive), split or loop (intrusive) modes. The various modes are described in the “[Test Access Mode Definitions](#)” section on page 1-30.

**Note**

The connection is maintained only for the duration of the TL1 session (non-persistent).

**Note**

The TAP number is displayed at the output if the CONN-TACC command completes successfully.

Error Codes Supported:

RTBY—Requested TAP busy

RTEN—Requested TAP does not exist

SCAT—Circuit is already connected to another TAP

SRCN—Requested condition already exists

IIAC—Invalid access identifier (AID)

EANS—Access not supported

SRAC—Requested access configuration is invalid

The command in [Example 1-7](#) creates a connection between TAP with number one and the port/facility FAC-1-3 with access mode as MONE. The various modes are described in the “[Test Access Mode Definitions](#)” section on page 1-30.

Example 1-7 *CONN-TACC-T1::FAC-1-3:12::1:MD=MONE;*

```
DV9-99 1970-01-02 02:51:54
M 12 COMPLD
1
;
```

1.11.4 Change Access Mode

The CHG-ACCMD command (CHG-ACCMD-<rr>) is used to change the access mode.

Input Format: CHG-ACCMD-(T1, T3, STS1, STS3C, STS6C, STS9C, STS12C, STS24C, STS48C, VT1, DS1):[<TID>]:<TAP>:<CTAG>::<MD>;

Change the type of test access. This may be a change from monitoring the data to inserting data into the STS. This command can only be applied to an existing TAP connection. If a TAP connection does not exist, a RTEN error is returned.

Error codes supported:

SRCN—Requested condition already exists

SRAC—Requested access configuration is invalid

RTEN—Requested TAP does not exist

The command in [Example 1-8](#) changes the access mode of TAP 1 to LOOPE.

Example 1-8 *CHG-ACCMD-T1::1:12::LOOPE;*

```
DV9-9 1970-01-02 02:59:43
M 12 COMPLD
;
```



Note

The access mode cannot be changed if the TAP is not connected.

1.11.5 Disconnect Test Access Points

TAPs can be disconnected in the following ways:

- Issue the DISC-TACC command
- Delete or modify accessed connection
- Drop the TL1 session for any reason, including logout or a dropped telnet session
- Switch or reset a TCC+/TCC2or XTC

The DISC-TACC command disconnects the <TAP> and puts the connection back to it's original state (no access). To issue the DISC-TACC command, follow the input format and examples shown below:

Input Format: DISC-TACC:[<TID>]:<TAP>:<CTAG>;

The command in [Example 1-9](#) disconnects TAP 1 from the circuit/cross-connect under test.

Example 1-9 *DISC-TACC::1:12;*

```
DV9-99 1970-01-02 02:59:43
M 12 COMPLD
;
```

Error codes supported:

SADC—Already disconnected

SRTN—Unable to release TAP

1.11.6 Delete Test Access Points

The command in [Example 1-10](#) deletes a TAP.

Example 1-10 *ED-<STS_PATH>:[<[TID]>]:<AID>:<CTAG>:::TACC=0;;*



Note

The TACC number must be set to zero in order to delete a TAP.



Note

If a TAP is not removed the STS bandwidth will be stranded.

1.11.7 Retrieve Test Access Point Information

The RTRV-TACC command retrieves TAP information. See the [“RTRV-TACC: Retrieve Test Access” section on page 3-304](#) for more information.

Input Format: RTRV-TACC:[<TID>]:<TAP>:<CTAG>;

<TAP> indicates the assigned numeric number for the AID being used as a test access point. The <TAP> number must be an integer with a range of 1–999. The ALL TAP value means that the command will return all the configured TACCs in the NE. <TAP> is a string and must not be null.

Example 1-11 RTRV-TACC::ALL:12;

```
PTLM6-454A59-52 1970-01-10 09:51:27
M 12 COMPLD
"1:STS-2-1,STS-2-2,MONE,STS-2-3,STS-2-4"
"2:VT1-1-1-1-1,VT1-1-1-2-1,MONF,VT1-1-1-3-1,VT1-1-1-4-1"
;
```

Parameter definitions:

- <TAP> indicates the assigned numeric number for the AID being used as a TAP; <TAP> is a string
- <TACC_AID1> is the STS or VT AID that was designated as a test access point and assigned to the TAP; <TACC_AID1> is from the [“ALL” section on page 4-9](#)
- <TACC_AID2> is the STS or VT AID that was designated as a test access point and assigned to the TAP+1; <TACC_AID2> is from the [“ALL” section on page 4-9](#)
- <MD> indicates the test access mode. It identifies the status of the circuit connected to the TACC. Valid values are shown in the [“TACC_MODE” section on page 4-97](#)
- <E_CONN> indicates the E side STS or VT AID of a circuit connected to the TACC or under test; <E_CONN> is from the [“ALL” section on page 4-9](#) and is optional
- <F_CONN> indicates the F side STS or VT AID of a circuit connected to the TACC or under test; <F_CONN> is from the [“ALL” section on page 4-9](#)

1.11.8 Test Access Configurations

Figure 1-3 Single node view (Node 1)

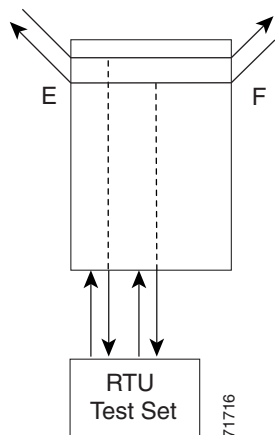

Example 1-12 *ED-ST51::STS-1-1:90::TACC=1;*

This command changes STS1 and STS2 on Slot 1 to a TAP. The <CTAG> is 90. Sets the TAP number to 1.

Example 1-13 *CONN-TACC-ST51::<AID for E or F depending on MD>:91::TAP-1:MONE*

This command connects the <AID> to the TACC defined by TAP 1 on the E side. <CTAG> is 91.

**Note**

The connection made in the CONN-TACC command can use MONE to connect to the F side <AID>. The <AID> provided designates the E side and the other automatically becomes the F side. For example, if an <AIDF> is supplied to a MONE connection the top line would be connected to the side of the path, or what is shown in the diagram as the F side. Once a CONN-TACC is set up, these designations cannot change until a DISC-TACC or another CONN-TACC command is issued. The connection is based on the <AID> supplied.

**Note**

In the [Figure 1-3](#) configuration there may be a single DS3 port wired-up but configured as 14 dual FADs (28 VTs).

Figure 1-4 Multi-node view (MONE example)

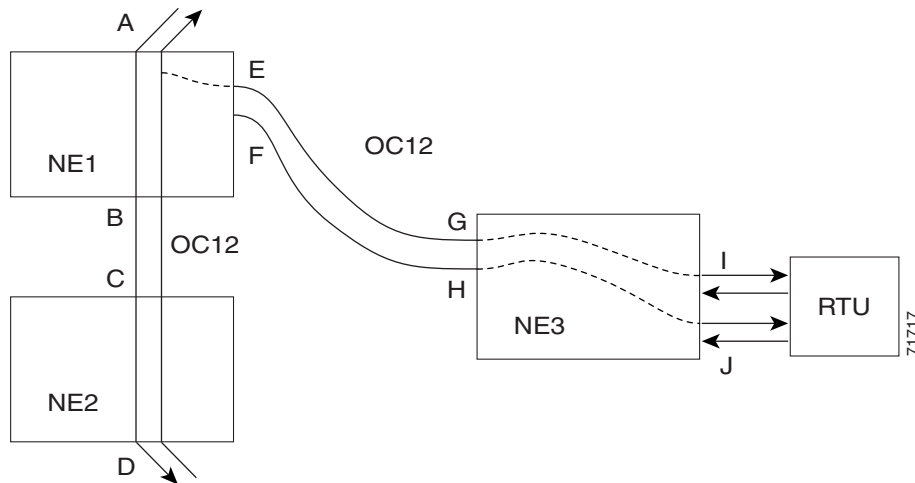

On NE3:

Example 1-14 *ENT-CRS-ST51::<AID I-G>:100::2WAY; A connection, not a TAP CTAG is 100.*
ENT-CRS-ST51::<AID J-H>:101::2WAY; Second connection, not a TAP.

On NE1:

Assuming the path from A to B is already entered; the A and B points in the diagram refer to entry and exit points on the node or different cards. The E/F designators refer to the two 2-way connections from NE3.

Example 1-15 *ED-STS1::STS-1-1:TACC=4;* Creates TAP with STS-1-1 and STS-1-2 through NE1. TAP number assigned is 4.

Example 1-16 *CONN-TACC-STS1::<AID A or B>:102::4:<MD>* Connects TAP #4 to the circuit.

**Note**

The I and J connections above are TAPs in [Figure 1-3](#), but normal connections in the [Figure 1-4](#) configuration.

1.11.9 Test Access Mode Definitions

The following diagrams show what the different test access modes <MD> refer to. [Figure 1-5](#) shows a circuit with no access followed by all the modes. The QRS may be generated by an outside source, i.e. the empty connection of the BRTU.

Figure 1-5 *Circuit with no access*

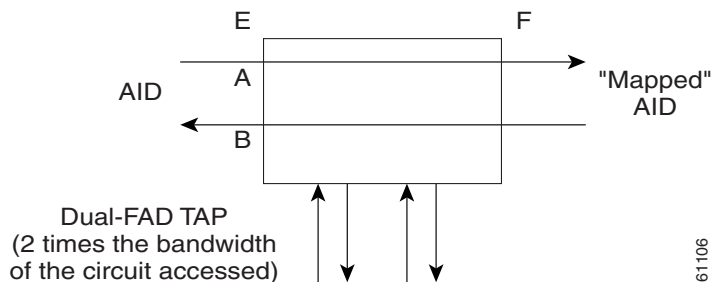

1.11.9.1 MONE

Monitor E (MONE) indicates a monitor connection provided from the facility access digroup (FAD) to the A transmission path of the accessed circuit ([Figure 1-6](#)). This is a non-intrusive mode.

Figure 1-6 *MONE access*

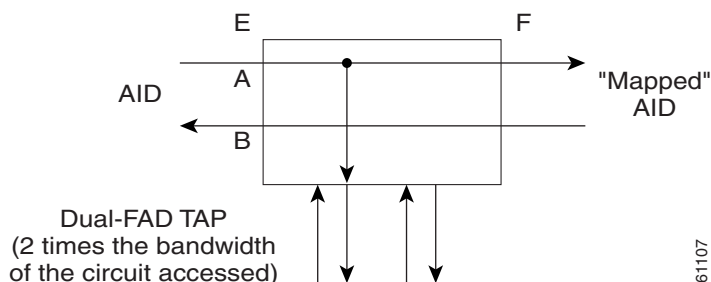

1.11.9.2 MONF

Monitor F (MONF) indicates that the FAD is providing a monitor connection to the B transmission path of the accessed circuit ([Figure 1-7](#)). This is a non-intrusive mode.

Figure 1-7 MONF access

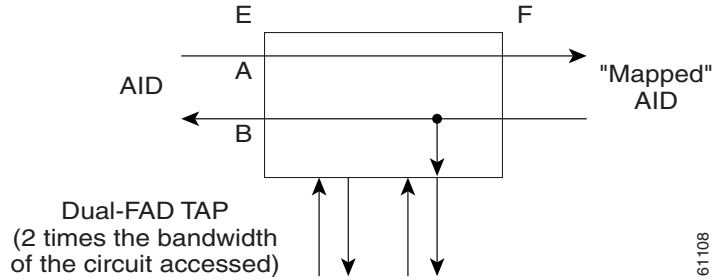

61108



Note

The MONE and SPLTA modes are applicable to unidirectional circuits from E to F. The MONF and SPLTB modes are applicable to unidirectional circuits from F to E.

1.11.9.3 MONEF

Monitor EF (MONEF) is a monitor connection provided from the FAD1 (odd pair) to a DFAD, to the A transmission path and from FAD2 (even pair) of the same DFAD, to the B transmission path of the accessed circuit. This is a non-intrusive mode.

MONEF for T3 (DS3 HCDS) indicates that the odd pair of a FAP is providing a monitor connection to the A transmission path and from the even pair of a facility access path (FAP) to the B transmission path of the accessed circuit.

Figure 1-8 MONEF access

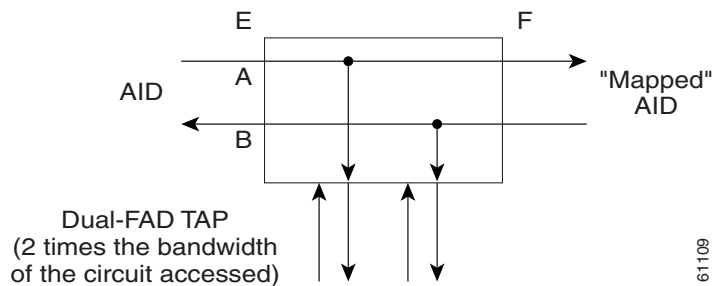

61109

1.11.9.4 SPLTE

Split E (SPLTE) indicates to split both the A and B paths and connect the E side of the accessed circuit to the FAD. Figure 1-9 through 1-11 show split E and F access modes.

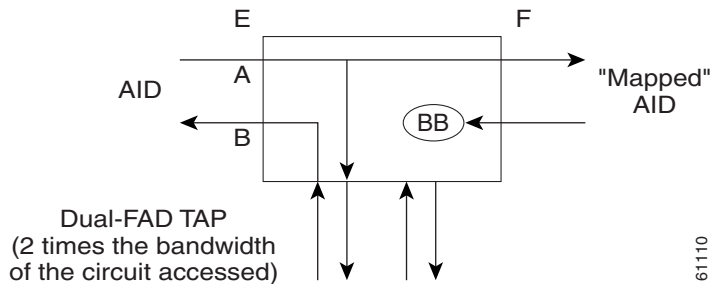
Figure 1-9 *SPLTE access*

1.11.9.5 SPLTF

Split F (SPLTF) indicates to split both the A and B paths and connect the F side of the accessed circuit to the FAD.

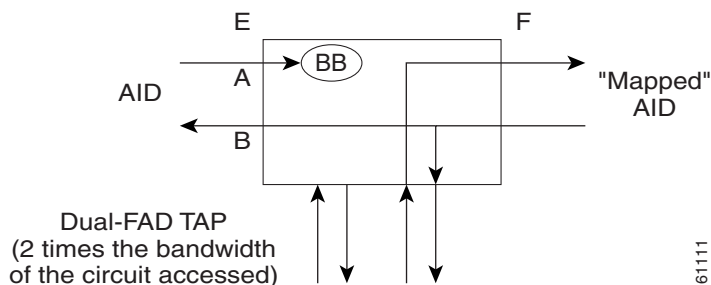
Figure 1-10 *SPLTF access*

1.11.9.6 SPLTEF

Split EF (SPLTEF) for T1 (DS1 HCDS) indicates to split both the A and B paths, connect the E side of the accessed circuit to FAD1 and the dual facility access digroup (DFAD) pair, and connect the F side to the FAD2 of the same DFAD pair. SPLTEF for T3 (DS3 HCDS) indicates to split both the A and B paths and connect the E side of the accessed circuit to the odd pair of the FAP and the F side to the even pair of the FAP.

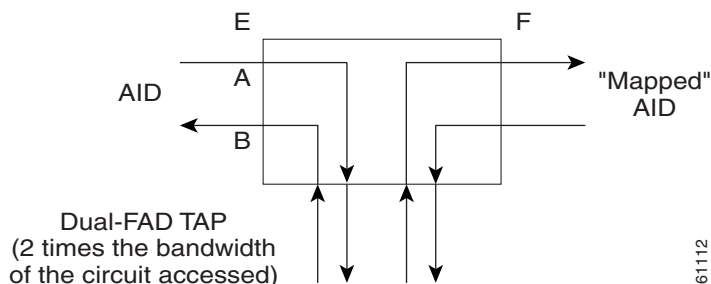
Figure 1-11 *SPLTEF access*

1.11.9.7 LOOPE

Loop E (LOOPE) indicates to split both the A and B paths, connect the incoming line from the E direction to the outgoing line in the E direction, and connect this looped configuration to the FAD. Loop E and F modes are basically identical to the SPLT E and F modes except that the outgoing signal is the incoming signal and not the signal from the remote test unit (RTU).

Figure 1-12 LOOPE access

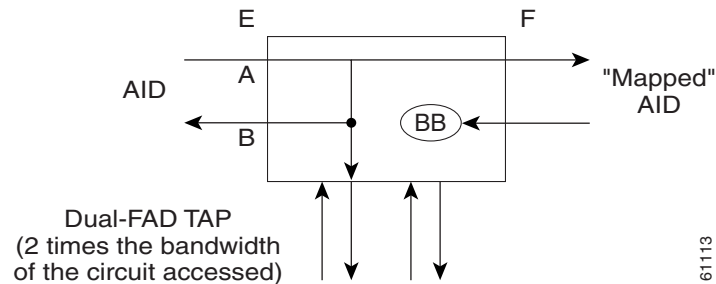

1.11.9.8 LOOPF

Loop F (LOOPF) indicates to split both the A and B paths, connect the incoming line from the F direction to the outgoing line in the F direction and connect this looped configuration to the FAD.

Figure 1-13 LOOPF access

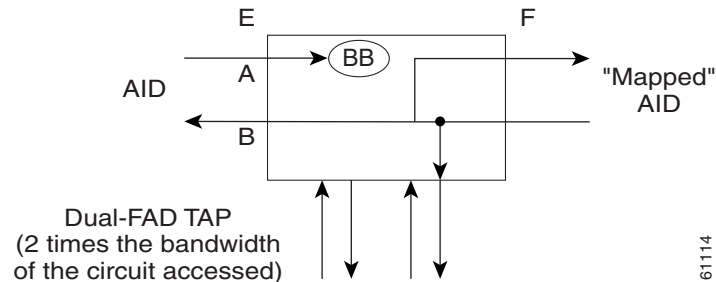

1.11.9.9 SPLTA

Split A (SPLTA) indicates that a connection is provided from both the E and F sides of the A transmission path of the circuit under test to the FAD and split the A transmission path. Split A and B access modes are shown in [Figure 1-14](#) and [Figure 1-15](#). These modes are similar to the Split E and F modes, except the signals are sent to the RTU, not the NE signal configuration.

Figure 1-14 SPLTA access

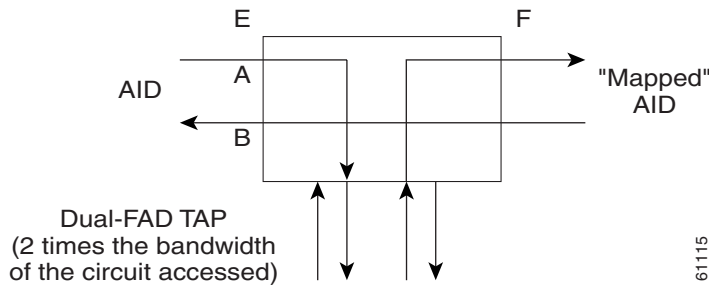

1.11.9.10 SPLTB

Split B (SPLTB) indicates that a connection is provided from both the E and F sides of the B transmission path of the circuit under test to the FAD and split the B transmission path.

Figure 1-15 SPLTB access

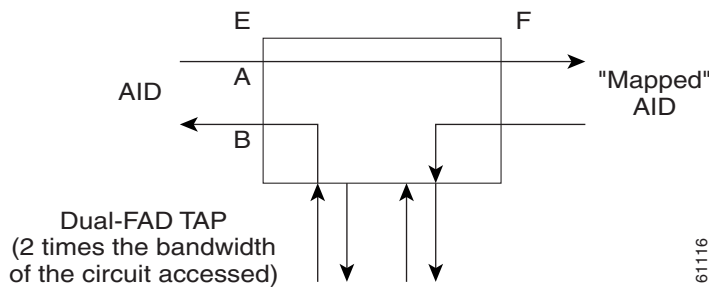

1.11.10 Unmapped AID Test Access Point Connections

The ONS 15454/15327 supports connections to unmapped AIDs (unmapped circuits). The TAPs can be connected to an unmapped AID, i.e. an AID that does not have a cross-connect on it. The access modes supported are: MONE, SPLTE, and LOOPE.

Example 1-17 `ED-STST1::STS-5-1:12::TACC=1;`

```
DV9-99 1970-01-02 03:16:11
M 12 COMPLD
;
```

This command creates a TAP on STS-5-1 and STS-5-2.

Example 1-18 `CONN-TACC-STST1::STS-5-3:12::1:MD=MONE;`

```
DV9-99 1970-01-02 02:51:54
```

```
M 12 COMPLD
1
;
```

**Note**

STS-5-3 does not have a cross-connect on it. This command creates an unmapped AID connection with the MONE access mode. STS-5-3 becomes unusable until the connection is disconnected by the DISC-TACC command.

**Note**

The <AID> provided in the CONN-TACC command designates the E side and the other automatically becomes the F side.

**Note**

In the case of all 1-way circuits (1-way, UPSR_HEAD, UPSR_DROP, UPSR_DC, UPSR_EN): If the <AID> specified is the source AID, the direction is designated as From E in the above table. If the <AID> specified is the destination AID or the drop side, the direction is designated as From F in the above table.

Examples:

The following examples assume an STS TAP is already created with TAP number = 1.

1.11.10.1 1-Way Circuit

```
Example 1-19 ENT-CRS-ST1::STS-5-1,STS-5-2:12::1WAY;
DV9-99 1970-07-01 20:29:06
M 12 COMPLD;
```

```
Example 1-20 CONN-TACC-ST1::STS-5-1:12::1:MD=MONF;
DV9-99 1970-01-01 20:29:47
M 12 DENY
EANS
STS-5-1
/*INCORRECT TAP MODE*/
```

The <AID> specified in the above CONN-TACC command is the source AID for the 1-way circuit. In this case only MONE and SPLTA modes are allowed because there is no B path in the case of a 1-way circuit (see [Table 1-3 on page 1-36](#)).

```
Example 1-21 CONN-TACC-ST1::STS-5-1:12::1:MD=MONE;
DV9-99 1970-01-01 20:30:09
M 12 COMPLD
```

```
Example 1-22 DISC-TACC::1:12;
DV9-99 1970-01-01 20:30:20
M 12 COMPLD
;
```

However if the <AID> specified is the destination AID as shown below, the modes allowed are MONF and SPLTB.

Example 1-23 *CONN-TACC-STS1::STS-5-2:12::1:MD=MONF;
DV9-99 1970-01-01 20:30:32
M 12 COMPLD*

Notes:

1. The same examples apply for UPSR_HEAD, UPSR_DROP, UPSR_DC and UPSR_EN which are all 1-way circuits.
2. The connections are made only to the working path irrespective of which path is currently active.

1.11.10.2 2-Way Circuits

For 2-way circuits all the modes are allowed as shown in [Table 1-3](#) and the same applies for UPSR_UPSR and path protection circuit types. In the case of UPSR_UPSR and path protection circuits the working path is connected irrespective of which path is currently active.

1.11.10.3 Unmapped AID

As explained in the [“Unmapped AID Test Access Point Connections”](#) section on page 1-34, connections can be made to an <AID> without a cross-connect on it. The modes supported are MONE, SPLTE and LOOPE as shown in [Table 1-3](#).

Table 1-3 *Modes Supported by Circuit Type*

	MONE	MONF	MONEF	SPLTE	SPLTF	SPLTEF	LOOPE	LOOPF	SPLTA	SPLTB
1-way (from E)	X								X	
1-way (from F)		X								
2-way	X	X	X	X	X	X	X	X	X	X
Path Protection	X	X	X	X	X	X	X	X	X	X
UPSR_HEAD (from E)	X								X	
UPSR_HEAD (from F)		X								X
UPSR_DROP UPSR_DC UPSR_EN (from E)	X								X	
UPSR_DROP UPSR_DC UPSR_EN (from F)		X								X
UPSR_UPSR	X	X	X	X	X	X	X	X	X	X
Unmapped AID	X			X			X			

1.12 TL1 PCA Provisioning

You can provision or retrieve protection channel access (PCA) cross-connections on two-fiber and four-fiber BLSR topologies at these supported OC rates: OC12 (two-fiber only), OC48, and OC192. The traffic on the protection channel is referred to as extra-traffic and has the lowest priority level.

Extra-traffic will be preempted by any working traffic that requires the use of the protection channel.

In a two-fiber BLSR the extra traffic is provisioned on the upper half of the bandwidth path. In a four-fiber BLSR the extra traffic is provisioned on the protect fiber. The PCA provisioning feature allows you to establish the PCA cross-connection on the protection path of the two-fiber BLSR and protection channel of the four-fiber BLSR only when the query is an explicit request.

There are two PCA connection types: 1WAYPCA and 2WAYPCA. The PCA cross-connection is provisioned only when the user provides an explicit request using the ENT-CRS-STSp/VT1 commands. If the cross-connection is a PCA cross-connection, either 1WAYPCA or 2WAYPCA is shown in the CCT field of the RTRV-CRS-STSp/VT1 command output.

1WAYPCA and 2WAYPCA are only used in the TL1 user interface to provide usability and visibility for the user to specify a PCA cross-connection type in the TL1 cross-connection commands.



Note

The network must be configured as either a two-fiber or four-fiber OC-12, OC-48, or OC-192 BLSR.



Note

The STS or VT1 path cross-connection can be established with TL1 commands (ENT-CRS-xxx).



Note

Because the RTRV-CRS-xxx command does not include the optional CTYPE field to specify a connection type, the output result reports the matched cross-connections based on the queried AID(s); therefore, the retrieved cross-connection inventory can be both PCA and non-PCA cross-connections.

1.12.1 Provision a PCA Cross-Connection

Input format for provisioning a PCA cross-connection:

Example 1-24 *ENT-CRS-<PATH>:[<TID>]:<FROM>,<TO>:<CTAG>::[<CCT>][:];*
<PATH>::={STS_PATH | VT1}
[<CCT>]::={1WAY, 1WAYDC, 1WAYEN, 2WAY, 1WAYPCA, 2WAYPCA}, it defaults to 2WAY.
{STS_PATH}::={STS1 | STS3C | STS6C | STS9C | STS12C | STS24C | STS48C | STS192C}

STS= all the STS bandwidth cross-connections.

VT1=VT1_5 cross-connection.

Input example of provisioning an STS3C PCA cross-connection:

Example 1-25 *ENT-CRS-ST33C::STS-1-1,STS-2-1:123::2WAYPCA;*



Note

If the [<CCT>] of this cross-connection provisioning command is either 1WAYPCA or 2WAYPCA, and the NONE of both <FROM> and <TO> AID is PCA AID, an IIAC (Input, Invalid PCA AIDs) error message is returned.

**Note**

If sending this command with a non-PCA connection type (CCT), and one (or two) AIDs is/are the PCA AIDs, an IIAC (The PCA AID Is Not Allowed for the Queried CCT Type) error message is returned.

1.12.2 Retrieve a PCA Cross-Connection

Input Format for retrieving a PCA cross-connection:

Example 1-26 *RTRV-CRS-[:<PATH>]:[:<TID>]:<AID>:<CTAG>[:<::>]:<PATH>::={STS_PATH | VT1 | STS }*

If PATH is STS, it will retrieve all the STS cross-connections based on the queried AIDs.

<AID>={FacilityAIDs, STSAIDs, VTAIDs, ALL}

Output format of the PCA STSp cross-connection retrieval command:

Example 1-27 *"<FROM>,<TO>:2WAYPCA,STS3C"*

Output format of the PCA VT cross-connection retrieval command:

Example 1-28 *"<FROM>,<TO>:2WAYPCA"*

1.13 FTP Software Download

The file transfer protocol (FTP) software download feature downloads a software package to the inactive flash partition residing on either the TCC+/TCC2 or XTC card. FTP software download provides for simplex and duplex TCC+/TCC2 or XTC card downloads, success and failure status, and in-progress status at 20% increments.

1.13.1 COPY-RFILE

The COPY-RFILE command downloads a new software package from the location specified by the FTP URL into the inactive flash partition residing on either the TCC+/TCC2 or XTC card.

Input format:

Example 1-29 *COPY-RFILE:[:<TID>]:[:<SRC>]:<CTAG>::TYPE=<XFERTYPE>,[SRC=<SRC1>]:*

where:

- SRC is the type of file being transferred and is from the [“RFILE” section on page 4-27](#)
- <XFERTYPE> is the file transfer protocol; valid values can be found in the [“TX_TYPE” section on page 4-100](#)
- <SRC1> specifies the source of the file to be transferred. Only the FTP URL is supported. In a non-firewall environment the format for the URL is:
“FTP://FTPUSER[:FTPPASSWORD]]@FTPHOST/PACKAGE_PATH”

where:

- userid is the userid to connect to the computer with the package file
- password is the password used to connect to the computer with the package file
- hostname is the IP address of the computer with the package file. DNS lookup of hostname is not supported.
- package_path is the long path name to the package file



Note Userid and password are optional if the user does not need to log into the host computer. The password may be optional if the user does not need to log in. All other portions of the URL are required, including the initial “FTP://” string.

In a firewall environment the hostname should be replaced with a list of IP addresses each separated by a “@” character. The first IP address should be for the computer where the package file is stored. Subsequent IP addresses are for firewall computers moving outward toward the edge of the network until the final IP address listed is the computer that outside users use to first access the network.

For example, if your topology is:

“FTPHOST <-> GNE3 <->GNE2 <-> GNE1 <-> ENE”

the FTP URL is:

FTP://FTPUSER:FTPPASSWORD@FTPHOST@GNE3@GNE2@GNE1/PACKAGE_PATH

SRC1 is a String

Notes:

1. SWDL is the only allowable <XFERTYPE>.
2. FTP is the only allowed file transfer method.
3. The use of the SWDL and the extended FTP URL syntax are required by the COPY-RFILE syntax.

1.13.2 APPLY

The APPLY command can activate or revert software depending on the version of software loaded on the active and protect flash. An error is returned if attempting to activate to an older software load or trying to revert to a newer software load. If this command is successful the appropriate flash is selected and the TCC+/TCC2 or XTC card will reboot.

Input format:

Example 1-30 *APPLY:[<TID>]::<CTAG>[::<MEM_SW_TYPE>]:*

where:

- <MEM_SW_TYPE> indicates memory switch action during the software upgrade.
<MEM_SW_TYPE> is ACT for activate and RVRT for revert.

1.13.3 REPT EVT FXFR

REPT EVT FXFR is an autonomous message used to report the start, completion, and completed percentage status of the FTP software download. REPT EVT FXFR also reports any failure during the software upgrade including invalid package, invalid path, invalid userid/password, and loss of network connection.

Note:

1. The “FXFR_RSLT” is only sent when the “FXFR_STATUS” is COMPLD.
2. The “BYTES_XFRD” is only sent when the “FXFR_STATUS” is IP or COMPLD.

Output format:

```
Example 1-31  SID DATE TIME
                A ATAG REPT EVT FXFR
                "<FILENAME>,<FXFR_STATUS>,<FXFR_RSLT>,<BYTES_XFRD>]"
                ;
```

where:

- <FILENAME> indicates the transferred file path name and is a string
- <FXFR_STATUS> indicates the file transferred status: Start, IP (in progress), or COMPLD
- <FXFR_RSLT> indicates the file transferred result: success or failure. <FXFR_RSLT> is optional
- <BYTES_XFRD> indicates the percentage transfer complete and is optional

1.13.4 Downloading New Software

The following procedure downloads new software to the TCC+/TCC2 or XTC card using TL1.

Download New Software



Note Only Superusers can download and activate software.

- Step 1** Copy the new software package (15454-0340-X02E-2804.pkg) to an FTP host.
- Step 2** Establish a TL1 session with the target NE.
- Step 3** Login with the ACT-USER command.
- Step 4** Check the working and protect software on the NE by issuing the RTRV-NE-GEN command.

Input example:

```
Example 1-32  RTRV-NE-GEN:::1;
```

Output example:

```
Example 1-33  VA454-94 1970-01-06 22:22:12
                M 1 COMPLD
                "IPADDR=1-.82.87.94,IPMASK=255.255.254.0,DEFRTR=10.82.86.1,
                ETHIPADDR=10.82.87.94,ETHIPMASK=255.255.254.0,NAME=VA454-94,
                SWER=3.40.00,LOAD=03.40-002G-14.21,PROTSWVER=4.00.00,
                PROTLOAD=04.00-X02G-25.07,DEFDESC=\\FACTORY DEFAULTS\\"
                ;
```

- Step 5** Issue the COPY-RFILE command. This command will initiate the download process. Refer to the “COPY-RFILE” section on page 1-38 for command syntax.

In the following example the package is located in “/USR/CET/VINTARA” in the host 10.77.22.199. The userid and passwords are TL1 and CISCO454. The directory path of the package is similar to what you will see during an FTP session.

```
Example 1-34 COPY-RFILE::RFILE-
PKG:CTAG::TYPE=SWDL, SRC="FTP://TL1:CISCO454@10.77.29.199
/USR/CET/VINTARA/15454-0340-X02E-2804.PKG";

DEV208 1970-01-10 11:51:57
M CTAG COMPLD
;
```

- Step 6** If any of the parameters are wrong or if the host is not accessible, a REPT EVT FXFR message will report from the following list. A download failure may be due to one or more of the following:
- Directory path of the package is invalid or not found
 - Package is invalid (i.e., ONS 15454 package on an ONS 15327, vice-versa, or an invalid file type)
 - Package not found on specified path
 - Userid/password or hostname is invalid
 - Host is not accessible
 - Firewall userid/password or host in invalid
 - Node rebooted/lost connection during download
 - If software download is already in progress
 - If the node or the host timed out during FTP protocol

```
Example 1-35 DEV208 1970-01-10 11:52:02
A 2816,2816 REPT EVT EQPT
"SLOT-11:SFTWDOWN-FAIL,TC,,,,,;"SOFTWARE DOWNLOAD FAILED\;TCC
;
```

- Step 7** If the download is successful the REPT EVT FXFR message will report an active start:

```
Example 1-36 DEV208 1970-01-10 11:52:15
A 2818,2818 REPT EVT FXFR
"ACTIVE START"
;
```

- Step 8** A SFTDOWN minor alarm is raised to indicate that the software download is in progress. The SFTDOWN alarm will clear when the download is complete.

```
Example 1-37 DEV208 1970-01--10 11:52:15
* 2817,2817 REPT ALM EQPT
"SLOT-7:MN,SFTWDOWN,NSA,,,,;"SOFTWARE DOWNLOAD IN PROGRESS\;TCC"
;
```

Use the in-progress status at any time during the software download to verify the RTRV-NE-GEN command.

Example 1-38 RTRV-NE-GEN

```
VA454-94 1970-01-06 22:22;12
```

```

M 1 COMPLD
"IPADDR=10.82.87.94,IPMASK=255.255.245.0,DEFRTR=10.82.86.1,
ETHIPADDR=10.82.87.94,EHTIPMASK=255.255.254.0,NAME=VA454-94,
SWVER=3.40.00,LOAD=03.40-002G-14-21,PROTSWVER=NONE,
PROTLOAD=DOWNLOADINPROGRESS,DEFDESC=\\FACTORY DEFAULTS\\"
;

```

- Step 9** The download progress is reported by the REPT EVT FXFR message which will report a message after every 20% of download is complete as shown:

```

Example 1-39  DEV208 1970-01-10 11:53:12
A 2820,2820 REPT EVT FXFR
"ACTIVE,IP,,20"
;

DEV208 1970-01-10 11:53:12
A 2820,2820 REPT EVT FXFR
"ACTIVE,IP,,40"
;

DEV208 1970-01-10 11:53:12
A 2820,2820 REPT EVT FXFR
"ACTIVE,IP,,60"
;

DEV208 1970-01-10 11:53:12
A 2820,2820 REPT EVT FXFR
"ACTIVE,IP,,80"
;

```

- Step 10** If the TL1 session times out during download or if the user terminates the TL1 session the download will continue. The download completion can be confirmed by issuing the RTRV-NE-GEN command and verifying the PROTLOAD.

Example 1-40 RTRV-NE-GEN:::1;

```

VA454-94 1970-01-06 22:22:12
M 1 COMPLD
"IPADDR=10.82.87.94,IPMASK=255.255.245.0,DEFRTR=10.82.86.1,
ETHIPADDR=10.82.87.94,EHTIPMASK=255.255.254.0,NAME=VA454-94,
SWVER=3.40.00,LOAD=03.40-002G-14-21,PROTSWVER=4.00.00,
PROTLOAD=03.40-X02E-28.04,DEFDESC=\\FACTORY DEFAULTS\\"
;

```

- Step 11** REPT EVT FXFR confirms the completion of the software download.

```

Example 1-41  DEV208 1970-01-10 12:01:16
A 2825,2825 REPT EVT FXFR
"ACTIVE,COMPLD,SUCCESS"
;

```

- Step 12** The SFTDOWN alarm clears when the download is complete.

```

Example 1-42  DEV208 1970-01-10 11:52:15
                * 2826,2817 REPT ALM EQPT
                "SLOT-7:CL,SFTWDOWN,NSA,,,,:\SOFTWARE DOWNLOAD IN PROGRESS\,TCC"
                ;

```

1.13.5 Activating New Software

After the software is successfully downloaded, the new software which resides in the protect load must be activated to run on the NE. The APPLY command can be used to activate and revert depending on the version of the protect software and the newly downloaded software (refer to the [“APPLY” section on page 1-39](#) for correct APPLY syntax).

Activate New Software

Step 1 If the protect software is newer than the working software, activate it as shown:

```

Example 1-43  APPLY::1::ACT;

                DEV208 1970-01-10 13:40:53
                M 1 COMPLD
                ;

```

An error is reported if a revert is attempted with a newer protect software.

Step 2 If the APPLY command is successful, logout of the TL1 session using the CANC-USER command:

```

Example 1-44  CANC-USER::CISCO15:1;

                VA454-94 1970-01-07 01:18:18
                M 1 COMPLD
                ;

```

After a successful completion of the APPLY command the NE will reboot and the TL1 session will disconnect. When the NE comes up after the reboot it will be running the new software. Traffic switches are possible during activation.

1.13.6 Remote Software Download/Activation Using the GNE

In a network with SDCC-connected ONS 15454 and ONS 15327s, remote download and activation are possible using the GNE/ENE feature supported in TL1. The GNE must be connected by a LAN and the remaining ENEs can download the new software package through fiber from the GNE.

For remote software downloading, complete the steps in the [“Download New Software” procedure on page 1-40](#) and the [“Activate New Software” procedure on page 1-43](#), but ensure that the TID in each command is filled with the ENE node name.

A maximum of 5 ENEs (an additional session through craft interface) can be contacted using the GNE sessions through the GNE by opening a single TL1 session on the GNE. For more information on TL1 Gateway, see [Chapter 2, “TL1 Gateway.”](#)

Example 1-45 *ACT-USER:NODE1:CISCO15:1;
ACT-USER:NODE2:CISCO15:1;
ACT-USER:NODE3:CISCO15:1;
ACT-USER:NODE4:CISCO15:1;
ACT-USER:NODE5:CISCO15:1;*

Five simultaneous software downloads can be initiated using the COPY-RFILE command with appropriate TIDs. All downloads will be independent of each other and download speeds may differ.

Example 1-46 *COPY-RFILE:NODE1:RFILE-PKG:CTAG::TYPE=SWDL,SRC="FTP://TL1:
CISCO454@10.77.29.199/USR/CET/VINTARA/15454-0340-X02E-2804.PKG";

COPY-RFILE:NODE2:RFILE-PKG...
COPY-RFILE:NODE3:RFILE-PKG...
COPY-RFILE:NODE4:RFILE-PKG...
COPY-RFILE:NODE5:RFILE-PKG...*

Individual REPT EVT FXFR messages can be isolated using the node names. RTRV-NE-GEN also requires the individual node names entered in the TID to see a specific download status.

You can activate the software on all of the nodes using the GNE node.

**Note**

Activate the GNE last, after activating all the ENEs or else ENE connectivity will be lost when the GNE starts to reboot for activation.

Example 1-47 *APPLY:NODE1::1::ACT;
APPLY:NODE2::1::ACT;
APPLY:NODE3::1::ACT;
APPLY:NODE4::1::ACT;
APPLY:NODE5::1::ACT;*