



Model D9482 DAVIC QPSK Modulator Installation and Operation Guide

Please Read

Important

Please read this entire guide. If this guide provides installation or operation instructions, give particular attention to all safety statements included in this guide.

Notices

Trademark Acknowledgments

Cisco and the Cisco logo are trademarks or registered trademarks of Cisco and/or its affiliates in the U.S. and other countries. To view a list of cisco trademarks, go to this URL: www.cisco.com/go/trademarks.

Third party trademarks mentioned are the property of their respective owners.

The use of the word partner does not imply a partnership relationship between Cisco and any other company. (1110R)

Publication Disclaimer

Cisco Systems, Inc. assumes no responsibility for errors or omissions that may appear in this publication. We reserve the right to change this publication at any time without notice. This document is not to be construed as conferring by implication, estoppel, or otherwise any license or right under any copyright or patent, whether or not the use of any information in this document employs an invention claimed in any existing or later issued patent.

Copyright

© 2001, 2012 Cisco and/or its affiliates. All rights reserved. Printed in the United States of America.

Information in this publication is subject to change without notice. No part of this publication may be reproduced or transmitted in any form, by photocopy, microfilm, xerography, or any other means, or incorporated into any information retrieval system, electronic or mechanical, for any purpose, without the express permission of Cisco Systems, Inc.

Contents

Safety Precautions	ix
Read and Retain Instructions	ix
Symbols Used	ix
Heed Warnings.....	ix
Avoid Electric Shock.....	ix
Servicing.....	ix
Cleaning, Water, Moisture, Open Flame	x
Ventilation.....	x
Placement	x
Portable Cart Warning	xi
Fuse	xi
Grounding (For United States and Canada)	xi
Safety Plugs.....	xi
Grounding Terminal.....	xi
Software Warranty and Disclaimer	xiii
Statement.....	xiii
Disclaimer	xiii
Customer Responsibility.....	xiii
Limitation of Liability.....	xiv
Hardware Warranty and Disclaimer.....	xv
Statement.....	xv
Warranty Period.....	xv
Disclaimer	xv
Purchaser's Responsibility	xv
Claims Under This Warranty	xvi
Limitation of Liability.....	xvi

Contents, Continued

Preface

About This Guide.....	xvii
Introduction	xvii
Audience	xvii
Scope	xvii
Additional Publications	xvii
Document Version	xvii

Chapter 1 Introducing the DAVIC QPSK Modulator

Overview	1-1
Introduction	1-1
In This Chapter.....	1-1
System Overview	1-2
Introduction	1-2
The Modulating-Demodulating Process.....	1-2
Diagram of DBDS Major Components.....	1-3
Major Parts and Functions of the QPSK Modulator	1-4
Major Components of the QPSK Modulator.....	1-5
The QPSK Modulator and the QPSK Demodulator.....	1-6
Communication Path.....	1-6
Communication Diagram	1-6
Front Panel Overview	1-7
Introduction	1-7
Front Panel Diagram.....	1-7
Front Panel Components	1-7
Description of Components, Continued.....	1-8
Back Panel Overview.....	1-9
Introduction	1-9
48 V DC Model	1-9
115 V AC Model	1-9
Description of Components.....	1-9
Description of Components, Continued.....	1-10

Continued on next page

Contents, Continued

Chapter 2	Installing the DAVIC QPSK Modulator	
	Overview	2-1
	Introduction	2-1
	Important.....	2-1
	In This Chapter.....	2-1
	Installation Prerequisites.....	2-2
	Introduction	2-2
	Rack Requirements	2-2
	Power Requirements	2-2
	Fuse Requirements.....	2-2
	Operating Temperature.....	2-3
	Unpacking and Inspecting.....	2-4
	Introduction	2-4
	Carrier’s Responsibility.....	2-4
	Unpacking and Inspecting Procedure.....	2-4
	Installing the QPSK Modulator Into a Rack.....	2-5
	Introduction	2-5
	Rack Requirements	2-5
	Mounting the Front Bezel	2-5
	Installing Additional Support	2-5
	Connecting the Serial Port	2-6
	Introduction	2-6
	Serial Port Location.....	2-6
	Connecting the Alarms Relays.....	2-7
	Introduction	2-7
	Description.....	2-7
	Procedure	2-7
	Connecting the E NET Port	2-8
	Introduction	2-8
	E NET Port Location.....	2-8

Continued on next page

Contents, Continued

	Connecting the ATM 25 Port.....	2-9
	Introduction	2-9
	ATM 25 Port Location	2-9
	Connecting the Demodulator Interface	2-10
	Introduction	2-10
	Demodulator Interface Port Connection to the Demodulator Network Data Port	2-10
	Connecting the RF OUT Port	2-11
	Introduction	2-11
	RF OUT Port Location.....	2-11
Chapter 3	Operating the DAVIC QPSK Modulator	
	Overview	3-1
	Introduction	3-1
	In This Chapter.....	3-1
	Default Status Screen.....	3-2
	Introduction	3-2
	Default Status Screen Information.....	3-2
	Front Panel Features	3-3
	Introduction	3-3
	Diagram of the Front Panel Menu Structure.....	3-3
	Accessing the QPSK Demodulator Features	3-4
	The ENTER Key	3-4
	Front Panel Indicators	3-4
	Self-Test Failure Indication.....	3-4
	FREQ Key Menus.....	3-5
	Setting the Output Frequency	3-5
	Procedure	3-5
	LEVEL Key Menus.....	3-6
	Setting the RF Output Level	3-6
	Procedure	3-6

Continued on next page

Contents, Continued

	CW Key Menu	3-7
	Setting the Carrier Mode.....	3-7
	Procedure	3-7
	OPTIONS Key Menus	3-8
	Introduction	3-8
	Menu Descriptions.....	3-8
	Routine Maintenance.....	3-10
	Introduction	3-10
	Quarterly Visual Inspection.....	3-10
	Spare Parts (Fuses)	3-10
	Fuse Replacement	3-11
	Fuse Replacement, Continued.....	3-12
Chapter 4	Customer Information	4-1
Appendix A	Technical Specifications	
	Overview	A-1
	Introduction	A-1
	In This Appendix	A-1
	Electrical Specifications	A-2
	Introduction	A-2
	Power Specifications.....	A-2
	RF Specifications	A-2
	RF Specifications, Continued.....	A-3
	Modulation Specifications	A-3
	Connector Type	A-4

Contents, Continued

- Other Specifications A-5
 - Introduction A-5
 - Frequency Requirements A-5
 - System Setting Recommendations..... A-5
 - Rack Specifications..... A-6
 - Overall Environmental Specifications..... A-6

Glossary

Compliance

- FCC Compliance
- Canadian EMI Regulation

Safety Precautions





Read and Retain Instructions

Carefully read all safety and operating instructions before operating this product, and retain them for future reference.

Symbols Used

 **WARNING:**
Avoid personal injury and product damage! Do not proceed beyond any symbol until you fully understand the indicated conditions.

The following symbols alert you to important information about the safe operation of this product:

-  You will find this symbol in the literature that accompanies this product. This symbol indicates important operating or maintenance instructions.
-  You may find this symbol affixed to this product. This symbol indicates a live terminal; the arrowhead points to the terminal device.
-  You may find this symbol affixed to this product. This symbol indicates a protective earth terminal.
-  You may find this symbol affixed to this product. This symbol indicates excessive or dangerous heat.

Heed Warnings

Follow all warnings and cautions in the operating instructions, as well as those that are affixed to this product.

Avoid Electric Shock

Follow the instructions in this warning.

 **WARNING!**
To reduce risk of electric shock, perform only the instructions that are included in the operating instructions. Refer all servicing to qualified service personnel.

Servicing

Do not open the cover of this product and attempt service unless instructed to do so in the operating instructions. Refer all servicing to qualified personnel only.

 **WARNING:**
Avoid electric shock! Opening or removing the cover may expose you to dangerous voltages.

Safety Precautions, Continued

Cleaning, Water, Moisture, Open Flame

To protect this product against damage from moisture and open flames, do the following:

- Before cleaning, unplug this product from the socket-outlet. Do *not* use liquid or aerosol cleaners. Use a damp cloth for cleaning.
- Do not expose this product to moisture.
- Do not place this product on a wet surface or spill liquids on or near this product.
- Do not place or use candles or other open flames near or on this product.

Ventilation

To protect this product against damage from overheating, do the following:

- This product has openings for ventilation to protect it from overheating. To ensure product reliability, do not block or cover these openings.
- Do not open this product unless otherwise instructed to do so.
- Do not push objects through openings in the product or enclosure.

Placement

To protect this product against damage from breakage, do the following:

- Place this product close enough to a mains AC socket-outlet to accommodate the length of the product power cord.
- Route all power supply cords so that people cannot walk on, or place objects on, or lean objects against them. This can pinch or damage the cords. Pay particular attention to cords at plugs, socket-outlets, and the points where the cords exit the product.
- Make sure the mounting surface or rack is stable and can support the size and weight of this product.

Safety Precautions, Continued

Portable Cart Warning

 **WARNING:**



Use this product only with a cart, stand, bracket, table, or other mounting accessories that meet Cisco specifications. Carefully follow all instructions for proper mounting.

Avoid personal injury and damage to this product! Move any appliance and cart combination with care. Quick stops, excessive force, and uneven surfaces may cause the appliance and cart to overturn.

Avoid personal injury and damage to this product! An unstable surface may cause this product to fall.

Fuse

To replace a fuse, do the following:

- Always use a fuse that has the correct type and rating. The correct type and rating are indicated on this product.
- Always disconnect all power cables before you change a fuse.

Grounding (For United States and Canada)

This section provides instructions for verifying that your equipment is properly grounded.

Safety Plugs

This product is equipped with a three-prong (grounding pin) plug--The middle prong on this plug is a protective grounding pin. Insert this plug into grounded mains, three-socket outlet. If you are unable to insert this plug fully into the socket-outlet, contact an electrician to replace your obsolete socket-outlet.

Grounding Terminal

If this product is equipped with an external grounding terminal, attach one end of an 14-gauge wire (or larger) to the grounding terminal; then, attach the other end of the wire to an earth ground, such as an equipment rack that is grounded.

Hardware Warranty and Disclaimer

Statement

Cisco warrants good title to any hardware furnished by it. For software, we warrant that we have the right to grant any software license granted. We warrant during the Warranty Period as defined below that services will be performed in a good and workmanlike manner. We also warrant that during the Warranty Period, each item we deliver (other than separately licensed software and services) (an “Item”) will be free from material defects in workmanship and materials and under ordinary use, conform in all material respects to its published specifications current at the time the Item was shipped.

Items may include refurbished goods, subassemblies or components, which we warrant as provided in this section.

Warranty Period

The Warranty Period begins on the date the Item is delivered and extends for 12 months for hardware and 90 days for software, parts and services. We will repair or replace, at our option, any product returned to us by the purchaser of such Item at the purchaser’s expense during the Warranty Period, which fails to satisfy this Warranty, unless the failure was the result of shipping; improper installation, maintenance or use; abnormal conditions of operation; attempted modification or repair by the purchaser; or an act of God. We will re-perform any services, which do not conform to this Warranty provided we have received notice of non-conformance within the Warranty Period.

Disclaimer

THIS WARRANTY IS IN LIEU OF ALL OTHER WARRANTIES, EXPRESS, IMPLIED OR STATUTORY, INCLUDING ANY WARRANTY OF MERCHANTABILITY, FITNESS FOR A PARTICULAR PURPOSE OR NONINFRINGEMENT. PURCHASER'S SOLE REMEDY FOR ANY BREACH OF WARRANTY IS THE REPAIR OR REPLACEMENT, AT CISCO'S OPTION, OF THE FAILED ITEM. CISCO SPECIFICALLY DISCLAIMS ANY AND ALL WARRANTIES, EXPRESS OR IMPLIED, TO CUSTOMERS OF THE PURCHASER.

Purchaser’s Responsibility

The purchaser must pay packing, crating, and transportation costs to and from the factory.

At the purchaser’s request, we will make reasonable efforts to provide warranty service at the purchaser’s premises, provided the purchaser pays our then current rates for field services and the associated travel and living expenses.

Hardware Warranty and Disclaimer, Continued

Claims Under This Warranty

In case of a claim under this warranty, the purchaser should do the following:

1. Notify us by giving the Item model number, serial number and details of the difficulty.
2. On receipt of this information, the purchaser will be given service data or shipping instructions.
3. On receipt of shipping instructions, forward the Item prepaid.
4. If the Item or fault is not covered by warranty, an estimate of charges will be furnished before work begins.

Limitation of Liability

EXCEPT FOR CLAIMS FOR PERSONAL INJURY CAUSED BY ITEMS FURNISHED BY Cisco, Cisco SHALL NOT BE LIABLE TO THE PURCHASER OR ANY OTHER PERSON OR ENTITY FOR INDIRECT, SPECIAL, INCIDENTAL, CONSEQUENTIAL, PUNITIVE, OR EXEMPLARY DAMAGES ARISING OUT OF OR IN CONNECTION WITH THE TRANSACTION IN WHICH THE ITEMS OR SERVICES WERE FURNISHED OR ANY ACTS OR OMISSIONS ASSOCIATED THEREWITH OR RELATING TO THE SALE OR USE OF ANY ITEMS OR SERVICES FURNISHED, WHETHER SUCH CLAIM IS BASED ON BREACH OF WARRANTY, CONTRACT, TORT OR OTHER LEGAL THEORY AND REGARDLESS OF THE CAUSES OF SUCH LOSS OR DAMAGES OR WHETHER ANY OTHER REMEDY PROVIDED HEREIN FAILS. IN NO EVENT SHALL Cisco'S TOTAL LIABILITY UNDER A CONTRACT EXCEED AN AMOUNT EQUAL TO THE TOTAL AMOUNT PAID FOR ITEMS PURCHASED UNDER SUCH CONTRACT.

Software Warranty and Disclaimer

Statement

CISCO, Inc. warrants that software licensed by it ("Licensed Software"), as provided, shall conform in all material respects to its published specifications current at the time the Licensed Software was shipped, downloaded or otherwise delivered to the Customer. During the first ninety (90) days after the date of delivery of Licensed Software, Cisco shall use reasonable commercial efforts to correct errors detected in Licensed Software after receiving notification of such errors from Customer.

Disclaimer

CISCO MAKES NO OTHER WARRANTIES, WHETHER EXPRESS OR IMPLIED, WITH RESPECT TO ANY LICENSED SOFTWARE, INCLUDING BUT NOT LIMITED TO ANY WARRANTIES OF MERCHANTABILITY OR FITNESS FOR A PARTICULAR PURPOSE. CISCO DOES NOT WARRANT THAT THE FUNCTIONS CONTAINED IN LICENSED SOFTWARE WILL MEET THE CUSTOMER'S REQUIREMENTS OR THAT THE OPERATION OF THE LICENSED SOFTWARE WILL BE UNINTERRUPTED OR ERROR-FREE. CISCO MAKES NO WARRANTY OF NON-INFRINGEMENT, EXPRESS OR IMPLIED. ANY THIRD PARTY SOFTWARE SUPPLIED WITH OR INCORPORATED IN LICENSED SOFTWARE IS PROVIDED "AS IS," WITHOUT WARRANTIES OF ANY KIND. IF ANY ADDITIONAL WARRANTIES ARE SUPPLIED BY A THIRD PARTY, SUCH WARRANTIES WILL BE OFFERED DIRECTLY BY SUCH THIRD PARTY TO CUSTOMER.

Customer Responsibility

Customer acknowledges its responsibility to use all reasonable methods to prove out and thoroughly test the operation of and output from Licensed Software prior to its use in Customer's operations.

Unless otherwise provided in a separate writing, and subject only to the warranty of this Section, Cisco is under no obligation to provide Customer with any modifications, updates, additions or revisions to Licensed Software, nor to maintain Licensed Software in any manner.

In the event that any modifications are made to Licensed Software which have not been authorized by Cisco, any and all warranty and other obligations of Cisco shall immediately cease with respect to such software.

Software Warranty and Disclaimer, Continued

Limitation of Liability

EXCEPT FOR CLAIMS FOR PERSONAL INJURY CAUSED BY LICENSED SOFTWARE FURNISHED BY CISCO, CISCO SHALL NOT BE LIABLE TO THE CUSTOMER OR ANY OTHER PERSON OR ENTITY FOR INDIRECT, SPECIAL, INCIDENTAL, CONSEQUENTIAL, PUNITIVE, OR EXEMPLARY DAMAGES ARISING OUT OF OR IN CONNECTION WITH THE TRANSACTION IN WHICH THE LICENSED SOFTWARE WAS FURNISHED OR ANY ACTS OR OMISSIONS ASSOCIATED THEREWITH OR RELATING TO THE SALE OR USE OF ANY LICENSED SOFTWARE FURNISHED, WHETHER SUCH CLAIM IS BASED ON BREACH OF WARRANTY, CONTRACT, TORT OR OTHER LEGAL THEORY AND REGARDLESS OF THE CAUSES OF SUCH LOSS OR DAMAGES OR WHETHER ANY OTHER REMEDY PROVIDED HEREIN FAILS. IN NO EVENT SHALL CISCO BE LIABLE TO CUSTOMER FOR ANY DAMAGES, HOWEVER BASED, IN EXCESS OF THE LESSER OF TEN THOUSAND UNITED STATES DOLLARS (U.S. \$10,000) OR THE LICENSE FEE PAID BY CUSTOMER TO CISCO FOR THE LICENSED SOFTWARE.

Preface

About This Guide

Introduction

The Model D9482 Digital Audio-Visual Council (DAVIC) Quadrature Phase-Shift Keying (QPSK) Modulator Installation and Operation Guide describes how to install, operate, and troubleshoot the DAVIC QPSK Modulator within the Digital Broadband Delivery System (DBDS). This guide provides an overview of the 115 V AC DAVIC QPSK Modulator (Cisco part number 591920) and the 48 V DC DAVIC QPSK Demodulator (Cisco part number 545600), and includes installation and operation procedures.

Audience

This guide is written for system administrators of the Digital Broadband Delivery System (DBDS), operators of the Digital Network Control System (DNCS), call center personnel, and system operators who are responsible for installing and operating the DAVIC QPSK Modulator. These individuals should have extensive working experience with cable communications equipment.

Scope

This guide provides the following topics:

- DAVIC QPSK Modulator function descriptions
- DAVIC QPSK Modulator component descriptions
- Installation procedures
- Operation procedures
- Troubleshooting guidelines
- Customer support information
- DAVIC QPSK Modulator technical specifications for installation

Additional Publications

Refer to the following Cisco publications for more information:

- *DBDS Troubleshooting Guide*, part number 565079
- *Digital Network Control System (DNCS) User's Reference Guide*, part number 565093
- *Digital Network Control System (DNCS) User's Guide*, part number 565062

Document Version

This is the FOURTH release of this guide. This guide includes the 115 V AC QPSK Modulator and updated technical specifications.

Chapter 1

Introducing the DAVIC QPSK Modulator

Overview

Introduction

This chapter provides descriptions of the DAVIC QPSK Modulator functions, how the DAVIC QPSK Modulator and the DAVIC QPSK Demodulator function together, and describes the front and back panel components.

Note: In this guide, the DAVIC QPSK Modulator and the DAVIC QPSK Demodulator will be referred to as the QPSK Modulator and the QPSK Demodulator.

In This Chapter

This chapter contains the following topics.

Topic	See Page
System Overview	1-2
The QPSK Modulator and the QPSK Demodulator	1-6
Front Panel Overview	1-7
Back Panel Overview	1-9

System Overview

Introduction

The QPSK Modulator is an integral component of the Cisco DBDS. The QPSK Modulator works with QPSK Demodulators and Digital Home Communication Terminals (DHCTs) to provide a forward signaling and reverse communications path for interactive two-way video and data services.

The Modulating-Demodulating Process

DHCT configuration and setup is initiated and controlled by the QPSK Modulator through the QPSK forward path. Messages are split into Asynchronous Transfer Mode (ATM) cells, formatted in DAVIC-compliant frames, QPSK modulated, and then transmitted to the DHCT at a rate of 1.544 Mbps. After the DHCTs are configured, all control and status information travels through the QPSK forward path, while all video and audio sources are carried by high-bandwidth Quadrature Amplitude Modulation (QAM) channels to the DHCT.

The QPSK Demodulator receives the messages that originate from a DHCT, such as a request for a service, on a 1.544 Mbps reverse path channel. The QPSK Demodulator demodulates the incoming QPSK signal, performs error correction on the detected data, and transmits the message as an ATM packet to the QPSK Modulator through an ATM-25 interface operating at 18.5 Mbps, and uses RJ-45 connectors.

Up to eight QPSK Demodulators can be connected to one QPSK Modulator, so the maximum sustained input rate to a modulator will be eight times the 1.544 Mbps rate, or approximately 12.4 Mbps to the DAVIC Router function of the QPSK Modulator.

The QPSK Modulator receives the ATM cells and uses the slot number information inserted by the QPSK Demodulator, along with the demodulator port number (for example, reverse channel number) to create a "success feedback" word to acknowledge or confirm receipt to the DHCT. These words generate the "acknowledge bits." The DHCT needs these bits to determine whether its cell was received successfully. ATM cells from DHCTs are routed to the main memory of the modulator, where complete messages are reassembled. The modulator processes these reassembled messages as a part of its Media Access Control (MAC) functions. The QPSK Modulator serves as a DAVIC Router by implementing the DAVIC MAC functions, and by communicating signaling and status information back to the DNCS through an Ethernet/IP connection.

System Overview, Continued

DBDS Major Components

The following diagram shows the major components of the DBDS. The QPSK Modulators are usually in hubs and work with QPSK Demodulators. Up to eight demodulators can be connected to each modulator.

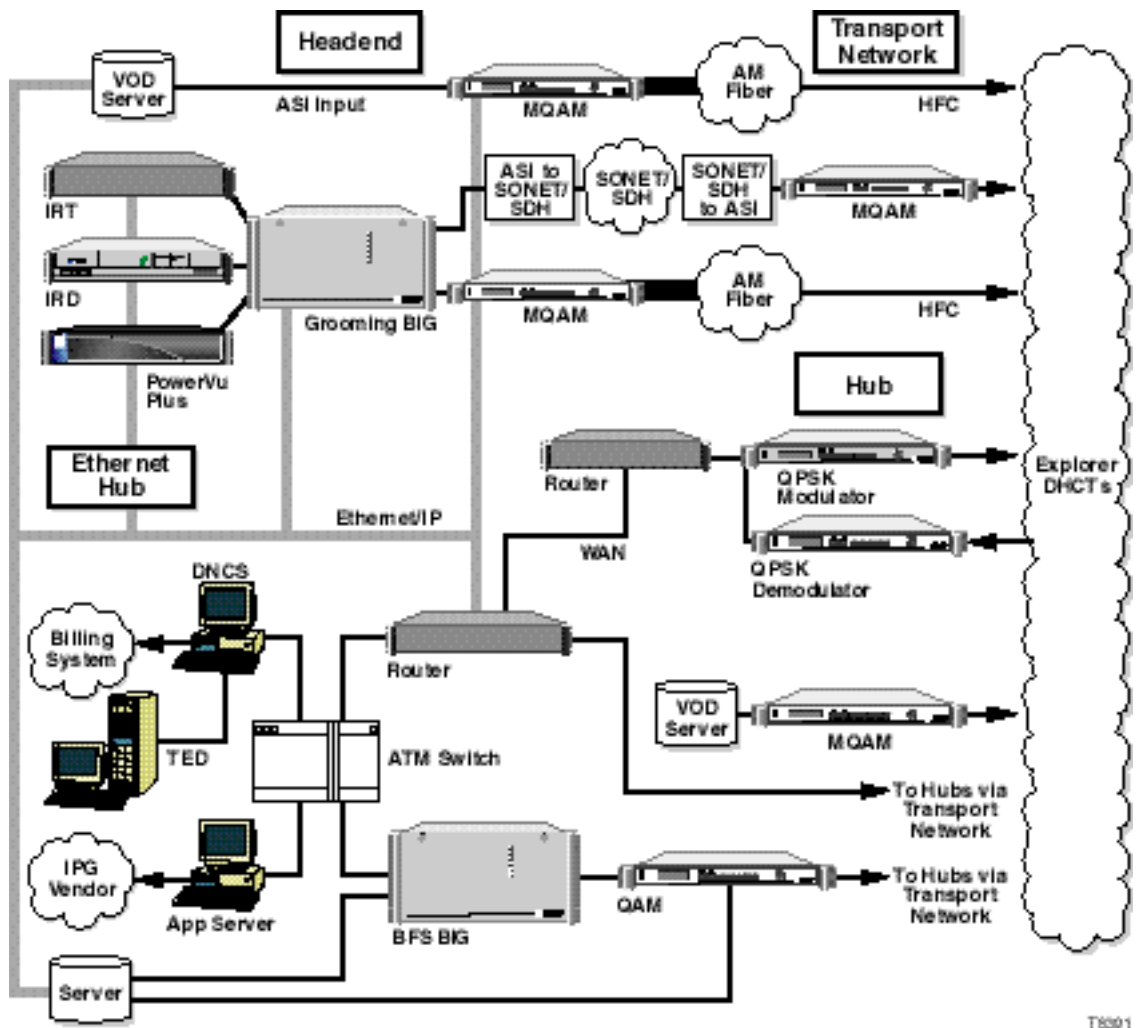

Note: Connections to the Cisco DNCS and other network elements are made through 10/100BaseT Ethernet links.

System Overview, Continued

Major Parts and Functions

The following table describes the internal components and functions of the QPSK Modulator.

Part	Function
Data Router Daughter board	Raw, demodulated ATM cells enter the unit through the Data Router Daughter board. The Data Router Daughter board contains all of the port connectors and analog signal conditioning required for each of the nine ATM links and the Ethernet link.
Data Router board	Data is moved from the data router daughter board to the Data Router board. ATM data is sent to the ATM packet routing logic, which processes each cell by looking at its virtual channel identifier/virtual path identifier (VCI/VPI) header. Control of the output converter, QPSK Modulator, front and back panels, and initialization of all other blocks is done through the I/O control and configuration logic on this board.
Modulator board	The Modulator board generates an intermediate frequency modulated signal that is sent to the output converter.
Output Converter board	The Output Converter board moves the signal to the desired channel and outputs it from the unit.
Data Processor board	The Data Processor board design is based on the Power PC603e microprocessor and the IBM 82663/664 Bridge chip set. The data processor consists of the PowerPC 603e microprocessor, the IBM 660 bridge set, system DRAM, a Level 2 cache, a system clock driver, and an Ethernet controller. The DAVIC MAC control code runs on this board.
Front panel	The front panel contains an LCD display, three LEDs, and seven keypad buttons (refer to Front Panel Overview later in this chapter).
Back panel	The back panel contains the serial port, major and minor alarm connections, the RJ-45 connector block for all nine ATM links and the Ethernet, and the RF output (refer to Back Panel Overview later in this chapter).

System Overview, Continued

Internal Components

Note: This illustration identifies the internal components and processes of the QPSK Modulator.

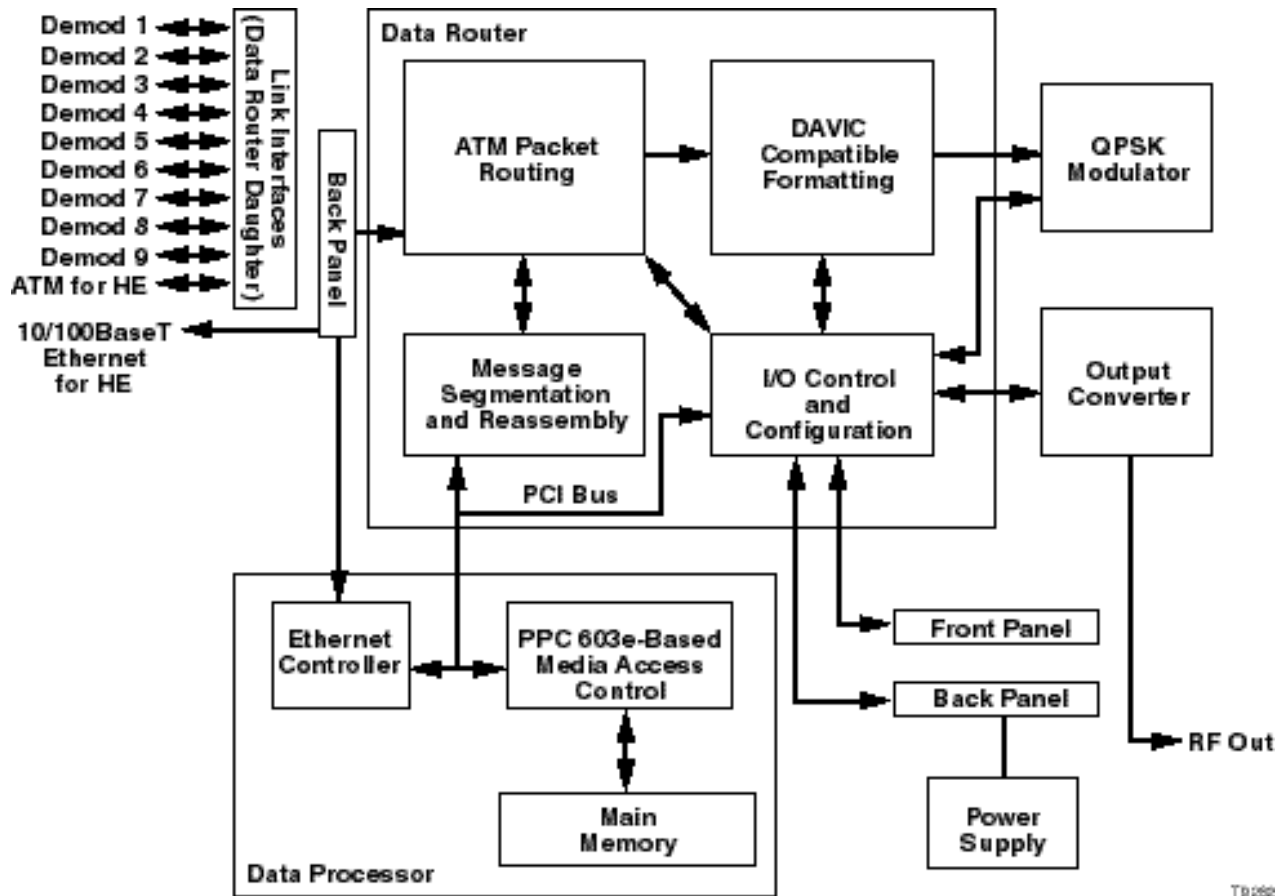

The QPSK Modulator and the QPSK Demodulator

Communication Path

The QPSK Modulator and QPSK Demodulator combine to create a DAVIC-compliant headend QPSK signaling hub. The following table illustrates this communication path.

From	To	Data
QPSK Modulator	QPSK Demodulator	<ul style="list-style-type: none"> • Embedded 3 ms reference • SMC provisioning data • SMC status requests
QPSK Demodulator	QPSK Modulator	<ul style="list-style-type: none"> • SMC Responses • Application data • MAC status data • MAC calibration requests

Communication Diagram

The following diagram illustrates the QPSK communication path.

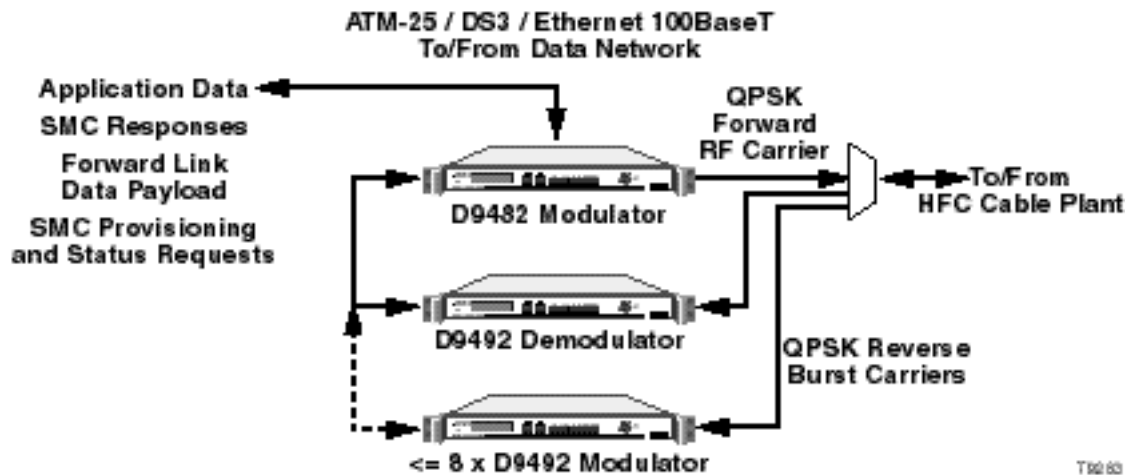

Front Panel Overview

Introduction

This section illustrates the front panel components of the QPSK Modulator.

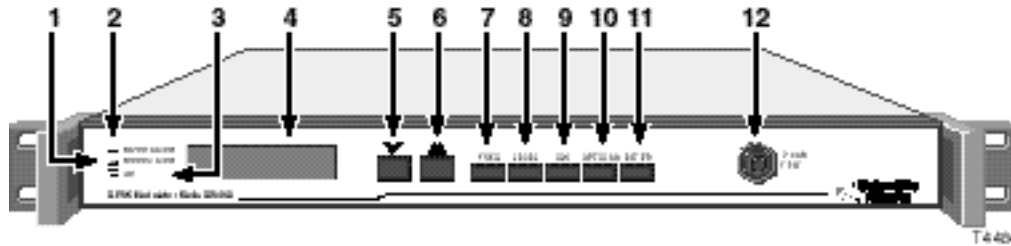

Front Panel Diagram

All controls for the unit are available on the front panel. The following illustration shows the front panel components.







Front Panel Components

The following table describes the front panel components.

Item	Component	Description
1	MINOR ALARM indicator (yellow)	Illuminates for a minor alarm.
2	MAJOR ALARM indicator (red)	Illuminates for a major alarm.
3	CW indicator (yellow)	Illuminates when the QPSK Modulator is in the continuous wave (CW) mode.
4	LCD alphanumeric display	Displays information and menus for the front panel keys.
5		Down key. Use this key to scroll down through menu selections.
6		Up key. Use this key to scroll up through menu selections.
7		Frequency key. Use this key to adjust the RF output frequency.

Front Panel Overview, Continued

Description of Components, Continued

Item	Component	Description
8	LEVEL 	Level key. Use this key to adjust the RF output level.
9	CW 	Continuous wave (CW) key. Use this key to set the QPSK Modulator to output either a modulated carrier, or an unmodulated (CW) carrier with the same average power as the modulated carrier.
10	OPTIONS 	Options key. Use this key to select various monitoring and set-up functions.
11	ENTER 	Enter key. Use this key to save configuration changes to nonvolatile memory.
12	 -20 dB TEST	BNC connector. Use this connector to analyze the modulated IF (baseband) signal.

Back Panel Overview

Introduction

This section illustrates the back panel components of the QPSK Modulator.

Back Panel Diagram

The following illustrations show the back panel components of both the 48 V DC Model and the 115 V AC Model QPSK Modulator.

48 V DC Model

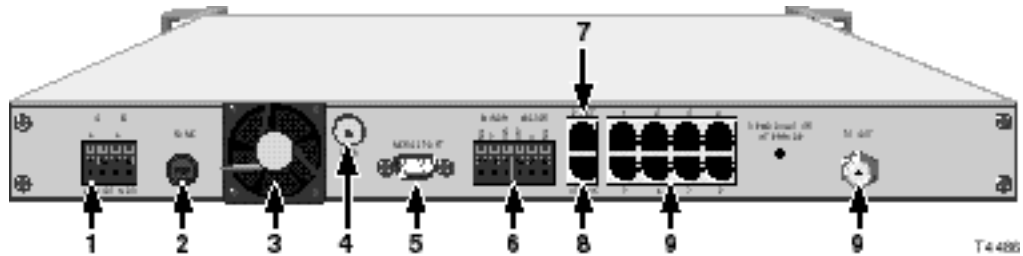

115 V AC Model

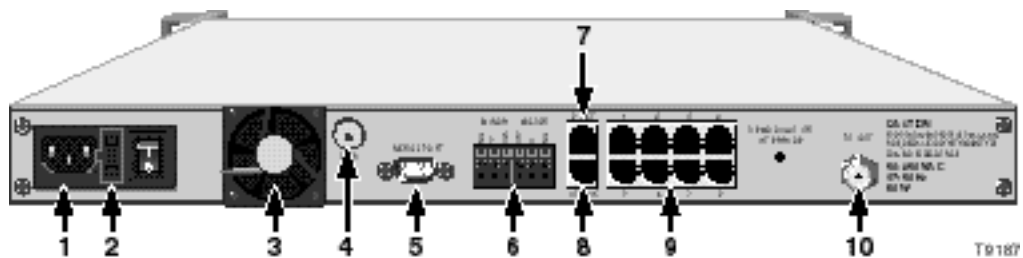

Back Panel Components

The following table describes the back panel components.

Item	Component	Description
1	Power Inlet	Screw-cage clamp terminal strip on the 48 V DC model; and a 3-prong male socket on the 115 V AC model
2	Fuse Holder	2.5 A Slo-Blo 250 V fuse on the 48 V DC model; and a 1.0 A Slo-Blo 250 V fuse on the 115 V AC model
3	Cooling Fan(s)	Removes heat from the chassis
4	GND	Ground screw for grounding the unit

Back Panel Overview, Continued

Back Panel Components, Continued

5	SERIAL PORT	DB-9 9-pin male connector for factory use only
6	ALARM RELAY	Screw-cage clamp terminal strip accesses the alarm relay connections
7	E-NET	RJ-45 jack connects to the DNCS Ethernet hub
8	ATM 25	RJ-45 jack connects to the headend
9	DEMODULATOR INTERFACE	8 RJ-45 jacks connect to between one and eight QPSK Demodulators
10	RF OUT	75 Ω female connector outputs the RF signal to the combining network

Chapter 2

Installing the DAVIC QPSK Modulator

Overview

Introduction

This chapter provides procedures for installing the QPSK Modulator into a rack and connecting the unit to other components.

Important

The QPSK Modulator must be installed in the system headend before any calibration or installation occurs.

In This Chapter

This chapter contains the following topics.

Topic	See Page
Installation Prerequisites	2-2
Unpacking and Inspecting	2-4
Installing the QPSK Modulator Into a Rack	2-5
Connecting the Serial Port	2-6
Connecting the Alarms Relays	2-7
Connecting the E NET Port	2-8
Connecting the ATM 25 Port	2-9
Connecting the Demodulator Interface	2-10
Connecting the RF OUT Port	2-11

Installation Prerequisites

Introduction

This section describes the rack, power, and operating temperature requirements.

Rack Requirements

The QPSK Modulator fits into a standard rack mount Type: EIA RS-310.

 **CAUTION:**
When installing the QPSK Modulator into a rack, be careful not to tangle or strain interconnecting cables.

Power Requirements

The QPSK Modulator requires a power source with the following specifications:

Item	Specification
Voltage (2 options)	-42 V DC to -56.7 V DC (option 1) 90 V AC to 260 V AC (option 2)  CAUTION: Avoid damaging the QPSK Modulator and creating a possible fire hazard! Connect the QPSK Modulator to a correct power source.
Power	< 65 Watts
Connector Specifications (2 options)	DC input (option 1 only) Terminal Block AC input (option 2 only) 3-prong male socket
Line Frequency	47 Hz to 63 Hz \pm 5%

Fuse Requirements

Keep spare fuses readily available. The fuse is user-serviceable.

- The 48 V DC QPSK Modulator uses a 2.5 A 250 V Slo-Blo power fuse.
- The 115 V AC QPSK Modulator uses a 1.0 A 250 V Slo-Blo power fuse.

Note: For information on replacing fuses, go to **Fuse Replacement** in the **Routine Maintenance** section of Chapter 3, **Operating the DAVIC QPSK Modulator**, later in this guide.

Installation Prerequisites, Continued

Operating Temperature

The operating temperature of this equipment is 0°C to 50°C (32°F to 122°F).

 **CAUTIONS:**

- **Avoid damage to this product! Your warranty is void if you operate this product above or below the maximum specified operating temperatures.**
- **Avoid damage to this product! Your warranty is void if you install this product without proper ventilation. Install 1U vent panels above and below each QPSK Modulator.**

To help keep the operating temperature in the acceptable range:

- Place the equipment in an air-conditioned environment
- Keep cooling vents obstruction-free

Unpacking and Inspecting

Introduction

This section describes the procedures to follow when unpacking and inspecting the QPSK Modulator.

Carrier's Responsibility

Cisco thoroughly inspects and carefully packs all products before shipment. The carrier is responsible for safe shipping and delivery. Do not return products damaged in transit to Cisco.

Note: Retain all boxes for future equipment shipping needs. They have been designed for use with this equipment.

Unpacking and Inspecting Procedure

Follow these steps to unpack and inspect the QPSK Modulator.

1. Review the Safety Precautions portion of this guide.
2. Inspect the shipping carton for visible damage.
3. Open the shipping carton.
4. Remove all packing material.
5. Inspect the product for visible damage.
6. Inspect for loose items that may indicate concealed damage.
7. Inspect for missing parts using the packing slip as a guide.

Note: If there is any missing parts or damage to the product, refer to Chapter 4, **Customer Information**, later in this guide.

Installing the QPSK Modulator Into a Rack

Introduction

This section describes the rack requirements, and the procedure for installing the QPSK Modulator into a rack.

Rack Requirements

The dimensions of the QPSK Modulator are: 1.50 in. H x 17.50 in. W x 18.00 in. D. The QPSK Modulator fits into a standard rack mount type: EIA RS-310.

CAUTIONS:

- Do not to tangle or strain interconnecting cables.
- Install 1U vent panels above and below each unit to prevent overheating.
- Be sure to install additional support (see below).

Mounting the Front Bezel

Follow these steps to mount the front bezel to the rack.

1. Place the QPSK Modulator in the rack.
2. Insert a mounting screw through each of the four bezel mounting holes on the front panel of the QPSK Modulator and then into the rack.

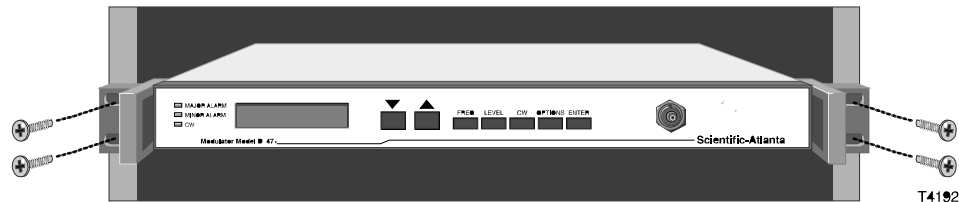

3. Firmly tighten each mounting screw.

Installing Additional Support

Due to the additional stress of wire connectors and cabling, additional support is necessary. The two methods needed to provide additional support are:

- Angle Support Brackets (part number 345763)
- Rack Slides (part number 275317)

Connecting the Alarms Relays

Introduction

This section describes the procedure for connecting the Alarms Relays.

Description

The QPSK Modulator includes Alarm Relay connections, labeled **MAJOR** and **MINOR**, for connecting visual or audible alarm indicators. These additional alarm indicators are optional since the front panel displays alarm messages. The relays provide both normally open (**NO**) and normally closed (**NC**) connections.

Procedure

Follow these steps to connect an indicator to one of the alarm relays.

1. Disconnect the power wires from the power supply.



Avoid electric shock when disconnecting the power supply. Only a qualified electrician should disconnect the power supply.

2. Determine whether the indicator trips on an open or closed circuit. Usually the external alarm should have this information.
 - A simple indicator (for example, an alarm based on a battery and beeper) would trip on a closed circuit (use the **NO** and **COM** terminals)
 - A more complex indicator (for example, a commercial alarm system) would trip on an open circuit (use the **NC** and **COM** terminals)

Note: The alarm connections power base ratio is 2 A at 50 V.

3. Use a small slotted screwdriver to gently push on and hold in the yellow tab, located at the top of each terminal.
4. Insert an indicator wire into the **NO**, **NC**, or **COM** terminal (see step 2 for determining which terminals to use).

Note: Make sure the contact closes on the bare wire, not the insulation.

5. Release the tab to secure the wire.
6. Repeat steps 4, 5, and 6 for additional connections, as needed.
7. Connect the power wires to the power supply.



Avoid electric shock when connecting the power supply. Only a qualified electrician should connect the power supply.

Connecting the ATM 25 Port

Introduction

A ninth **ATM 25** port is included in the QPSK Modulator for future use. It is electrically equivalent to the other eight ATM ports for connecting to QPSK Demodulators; but, the internal software of the QPSK Modulator services the port differently. Standard operation does not require that a connection be made to this port. To use this port, contact Cisco Services for further details.

ATM 25 Port Location

The following illustration shows the location of the ATM 25 port.

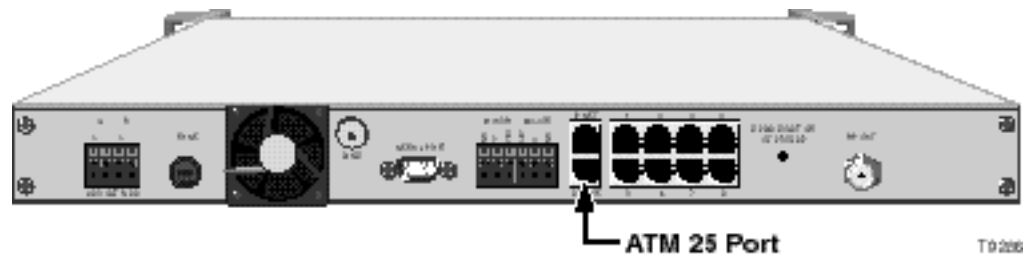

Connecting the Demodulator Interface

Introduction

The **DEMODULATOR INTERFACE** of the QPSK Modulator has port connections for up to eight QPSK Demodulators. The eight ports are electrically identical. They should be connected to the **NETWORK DATA** port of a QPSK Demodulator. The connections are controlled and managed by the modulator software. Each port is an ATM-25 interface that is configured for network mode.

The connections should be made using standard category 5 Ethernet cables, compatible with the ATM-25 specification, with RJ-45 connectors.

Demodulator Interface Port Connection to the Demodulator Network Data Port

The follow illustration shows the connection from the Demodulator Interface of the QPSK Modulator to the Network Data port of the QPSK Demodulator.

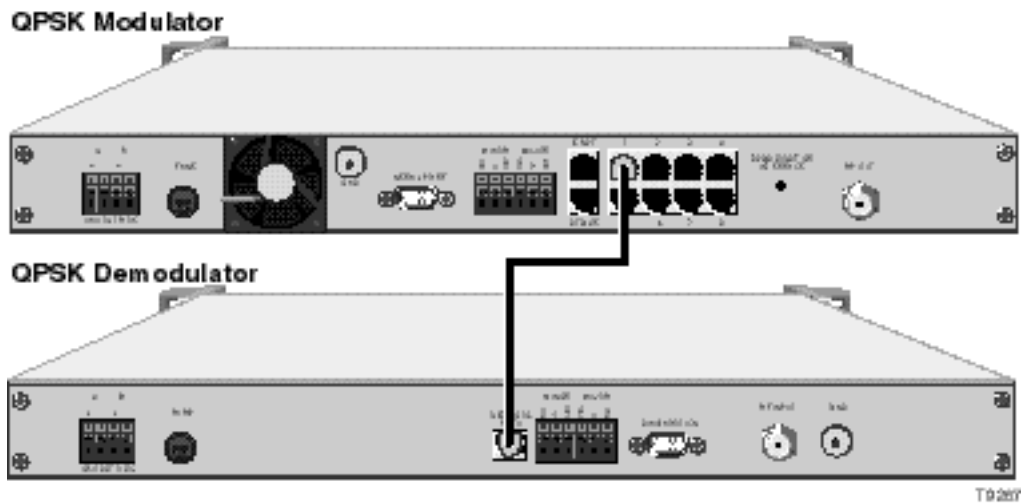

Connecting the RF OUT Port

Introduction

The **RF OUT** port of the QPSK Modulator connects to the combining network using a 75 Ω RG-59 coaxial cable. The interface connects to the **RF OUT** port of the QPSK Modulator to a system of combiners and RF input connectors linking to subscriber DHCTs.

⚠ CAUTION:

Turning on the QPSK Modulator with a default RF output level of 100% can drown out other signals. Set the RF output frequency and RF output level before you connect the RF OUT port to the network. See the **FREQ Key Menus and the **LEVEL Key Menus** sections of Chapter 3, **Operating the QPSK Modulator**, next in this guide, for instructions on setting the RF output frequency and RF output level.**

RF OUT Port Location

The following illustration shows the location of the RF Out port.

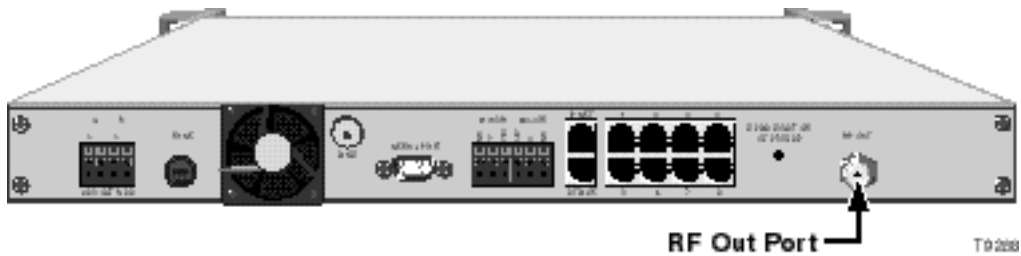

Chapter 3

Operating the DAVIC QPSK Modulator

Overview

Introduction

This chapter describes the front panel screens, the procedures for viewing and changing QPSK Modulator settings, and instructions for routine maintenance.

In This Chapter

This chapter contains the following topics.

Topic	See Page
Default Status Screen	3-2
Front Panel Features	3-3
FREQ Key Menus	3-5
LEVEL Key Menus	3-6
CW Key Menu	3-7
OPTIONS Key Menus	3-8
Routine Maintenance	3-10

Default Status Screen

Introduction

This section describes the Default Status screen. The QPSK Modulator displays the Default Status screen after one of the following events occurs:

- The power-on self-test sequence is complete.
- You press the **ENTER** key to complete a command.
- A minute elapsed since the last key was pressed.

Default Status Screen Information

The following is an example of the Default Status screen.

80.00 MHz	RF: 50%
Output Converter : LOCKED	

The following table describes the information displayed on the Default Status screen.

Display	Function
MHz	Current output frequency in megahertz
RF	Configured radio frequency output level (-10% to 110%)
Output Converter	Converter status (this should be LOCKED)

Front Panel Features

Introduction

The front panel has an alphanumeric LCD screen and three indicators that display information to the operator. Four keys on the front panel allow you to change various parameters of the QPSK Modulator. You can access other menus and screens by pressing the following front panel keys: **FREQ**, **LEVEL**, **CW**, and **OPTIONS**.

Diagram of the Front Panel Menu Structure

The following diagram illustrates the QPSK Modulator menu structure.

Note: The settings shown on this menu are examples, not recommended settings.

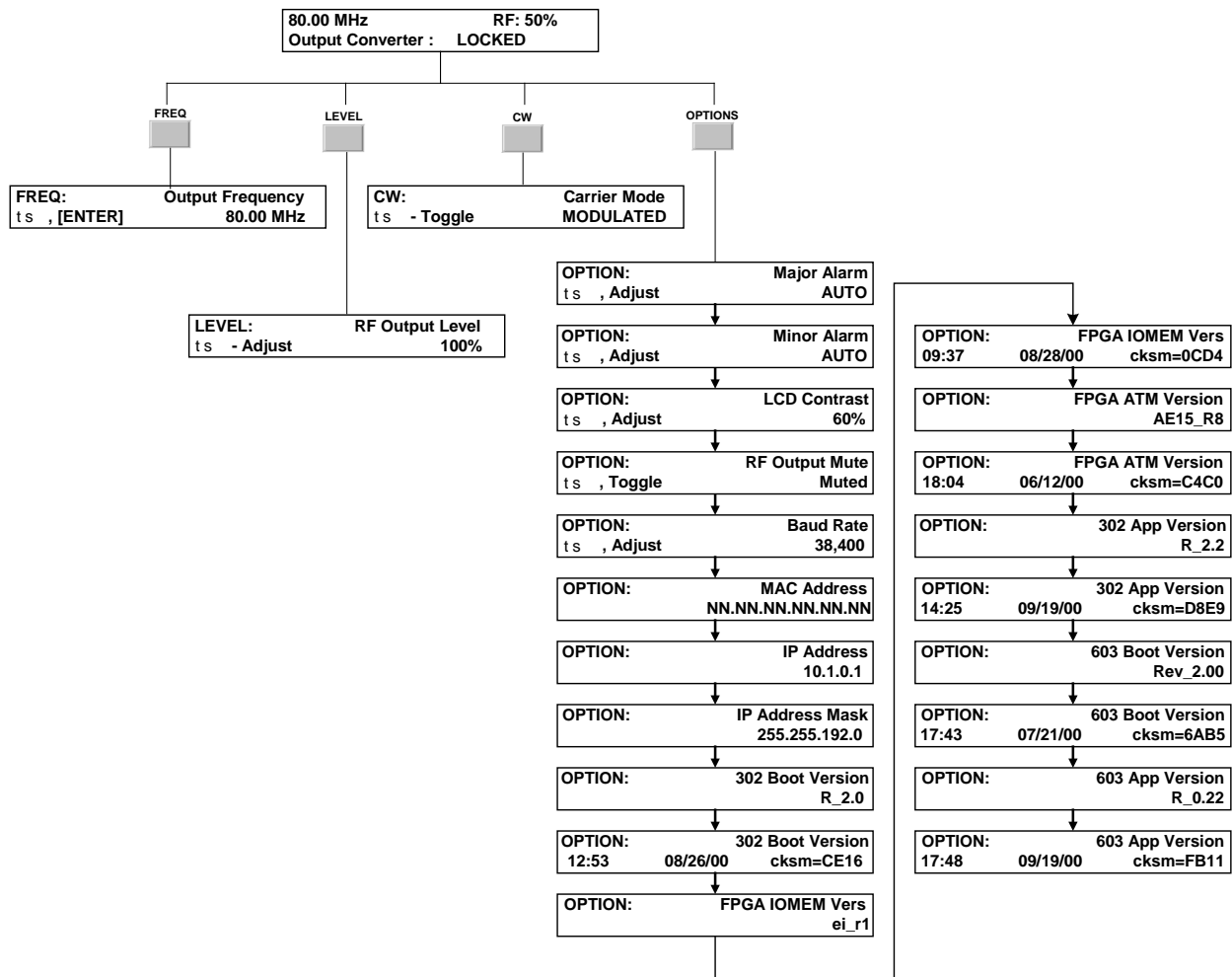

Front Panel Features, Continued

Accessing the QPSK Demodulator Features

You can access other menus and screens by pressing the following front panel keys: **FREQ**, **LEVEL**, **CW**, and **OPTIONS**. This section provides detailed instructions for using these keys.

The ENTER Key

Use the **ENTER** key to store any changes to the configuration settings. Use this key also to control status tests.

Note: The QPSK Modulator stores configuration settings automatically if no front panel keys are pressed for a time period of one minute or more. The QPSK Modulator displays the default status screen after either storage method occurs.

Front Panel Indicators

The following LED indicators are located on the front panel:

- **Major Alarm** (red): This indicates a catastrophic failure.
- **Minor Alarm** (yellow): This indicates a non-catastrophic failure.
- **CW** (yellow): This indicates that the QPSK Modulator is in the CW mode.

Self-Test Failure Indication

If the QPSK Modulator fails any power-on self-test, one of the ALARM LEDs illuminates, and the screen displays an alarm message.

FREQ Key Menus

Setting the Output Frequency

When you press the **FREQ** key, the output frequency menu appears. Use this screen to change the output frequency.

Note: The frequency changes and saves to nonvolatile memory only when the **ENTER** key is pressed.

Procedure

Follow these steps to change the output frequency.

1. Press **FREQ** on the front panel of the QPSK Modulator.

Result: The Output Frequency screen appears.

FREQ: t s , [ENTER]	Output Frequency 80.00 MHz
-------------------------------	---

2. Press the up or down arrow keys to increase or decrease the output frequency in 0.25 MHz increments.



Note: The QPSK Modulator supports a frequency range from 54 MHz to 550 MHz.

3. Press the **ENTER** key to save the changes to nonvolatile memory and return to the default status screen.

LEVEL Key Menus

Setting the RF Output Level

When you press the **LEVEL** key, the RF Output Level menu appears. Use this screen to change the RF output level.

Note: When the RF output level is changed with the  and  keys, the change is saved to nonvolatile memory at that time. The **ENTER** key does not save the RF output level.

Procedure

Follow these steps to set the RF output level.

1. Press **LEVEL** on the front panel of the QPSK Modulator.

Result: The RF Output Level screen appears.

LEVEL:	RF Output Level
t s - Adjust	100%

2. Press the up or down arrow keys to increase or decrease the output level from 39 dBmV (-20%) to 51 dBmV (110%).

Note: The RF output is not disabled by 0%.

3. Press the **ENTER** key to return to the default status screen.

CW Key Menu

Setting the Carrier Mode

When you press the **CW** key the Carrier Mode menu appears. Use this screen to change the carrier mode level.

The **CW** menu lists two modes:

- Use this screen to set the QPSK Modulator to output a modulated (normal) carrier or a CW (unmodulated) carrier. Modulated is used for normal operation.
- Unmodulated - Continuous Wave (CW) carrier, is used for configuration and testing.

Procedure

Follow these steps to change the carrier mode.

1. Press the **CW** key on the front panel of the QPSK Modulator.

Result: The Carrier Mode screen appears.

CW: t s - Toggle	Carrier Mode MODULATED
----------------------------	---

2. Press the up or down arrow keys to toggle the carrier mode between **MODULATED** (normal) or **UNMODULATED**.
3. Press the **ENTER** key to save the changes to nonvolatile memory and return to the default status screen.

Note: A spectrum analyzer can be connected to the MONITOR port of the QPSK Modulator when the QPSK Modulator is in CW (unmodulated) mode.

OPTIONS Key Menus

Introduction

This section describes the **OPTIONS** key menus.

Menu Descriptions

The following screens appear when the **OPTIONS** key is pressed repeatedly.

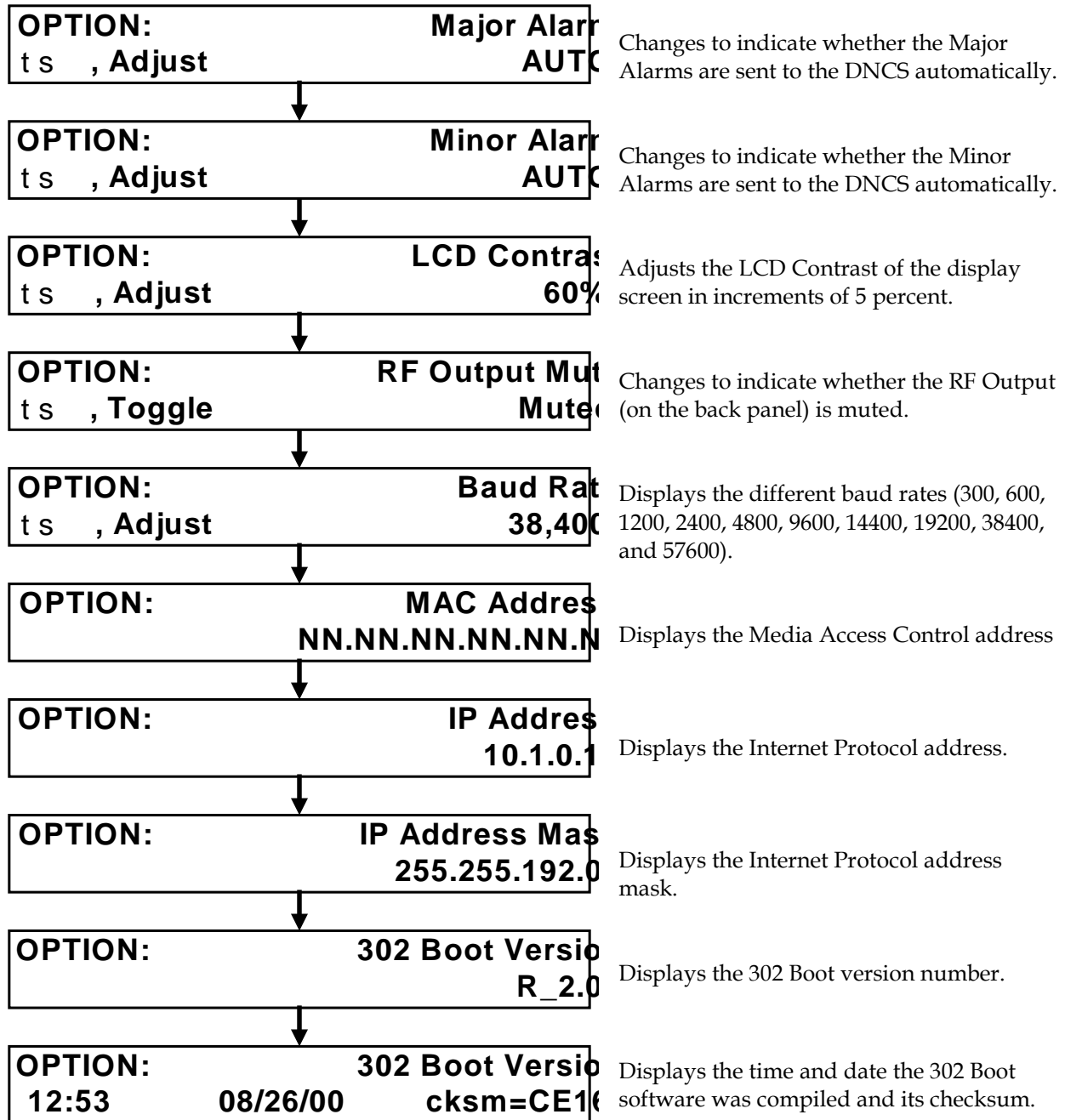

OPTIONS Key Menus, Continued

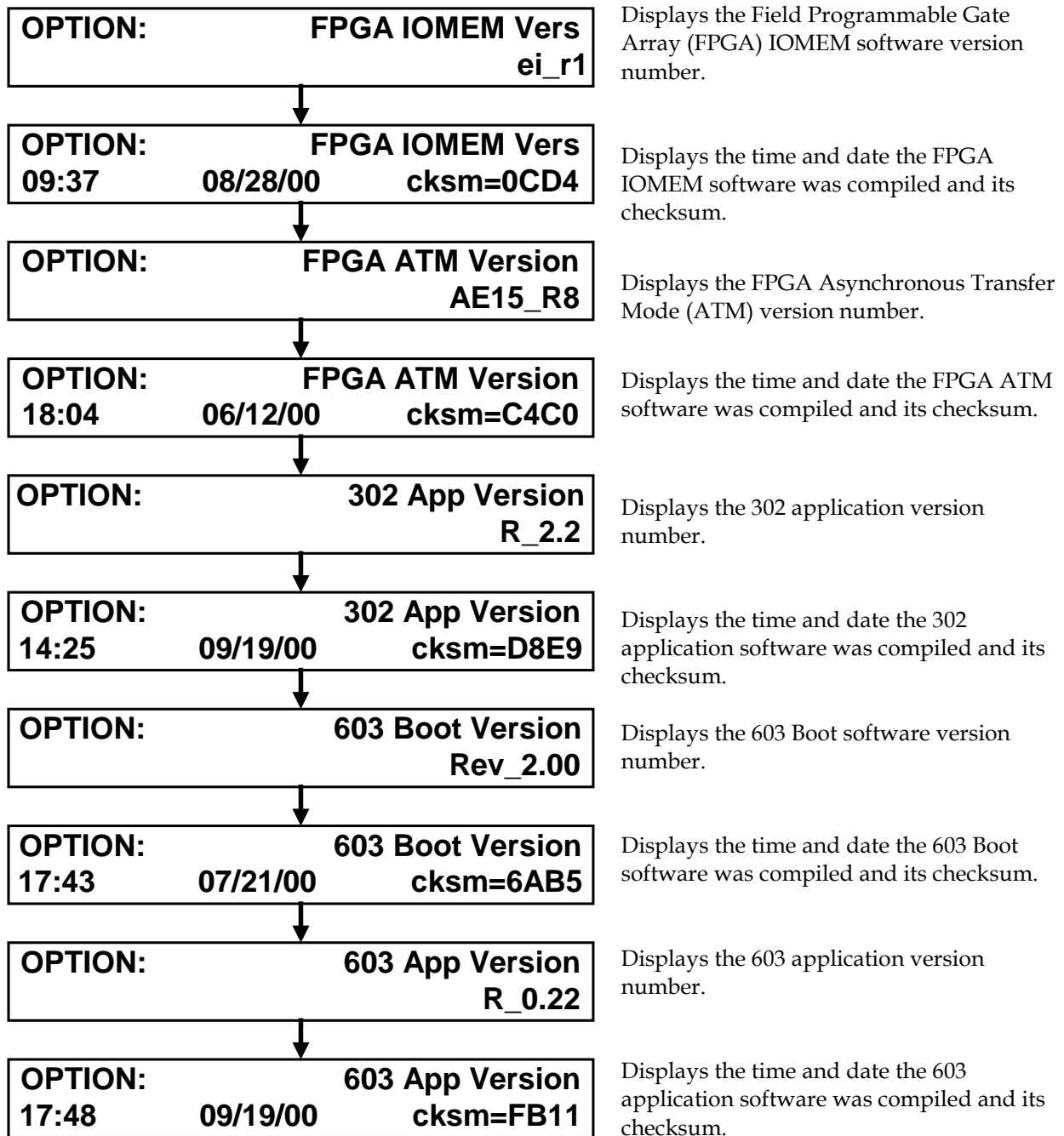

Routine Maintenance

Introduction

Carrying out routine maintenance helps prevent the need for troubleshooting. This section describes important routine maintenance procedures.



WARNING!

Avoid electric shock! Only qualified personnel should attempt maintenance and service of the QPSK Modulator.

Quarterly Visual Inspection

The QPSK Modulator can operate unattended for extended periods of time. If it is operating normally, do not remove cards or covers or make any adjustments. However, do conduct a visual inspection at least once every four months.

Check the following during a visual inspection:

- **Cables and connectors** – Make sure that all cables are connected properly, and that all retaining screws are tight. Inspect cables for stress and chafing.
- **Cover and back panel** – If necessary, clean the cover and back panel with a soft cloth dampened with a mild detergent solution.

Spare Parts (Fuses)

Note: Keep spare fuses readily available.

- The 48 V DC QPSK Modulator uses a 2.5 A 250 V Slo-Blo power fuse.
- The 115 V QPSK Modulator uses a 1.0 A 250 V Slo-Blo power fuse.

For replacing fuses, go to **Fuse Replacement**, next in this section

Routine Maintenance, Continued

Fuse Replacement

Follow these steps to replace the 2.5 A 250 V fuse in the 48 V DC model.

WARNINGS!

- **Avoid electric shock! Disconnect the power cord on this product before you remove the fuse.**
- **Avoid electric shock and damage to this product! Replace the fuse only with a fuse that is the correct type and rating.**

1. Locate the fuse holder on the left side of the back panel.

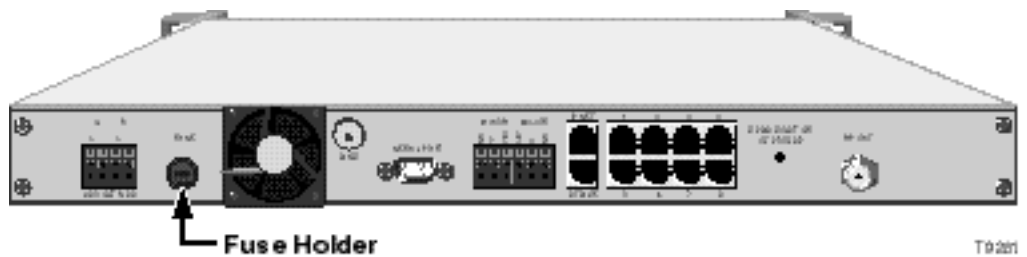

2. Turn the fuse casing counter-clockwise with a small, flat-blade screwdriver to unlock the casing.
3. Pull the fuse holder from the back panel.
4. Remove the blown fuse and replace it with a new one.
5. Reinsert the fuse holder into the back panel.
6. Turn the fuse casing in and clockwise with a small, flat-blade screwdriver to lock the casing.
7. Reconnect the power cord.

Routine Maintenance, Continued

Fuse Replacement, Continued

Follow these steps to replace the 1.0 A 250 V fuse in the 115 V AC model.

WARNINGS!

- **Avoid electric shock! Disconnect the power cord on this product before you remove the fuse.**
- **Avoid electric shock and damage to this product! Replace the fuse only with a fuse that is the correct type and rating.**

1. Locate the fuse holder located between the power plug and the on-off switch.

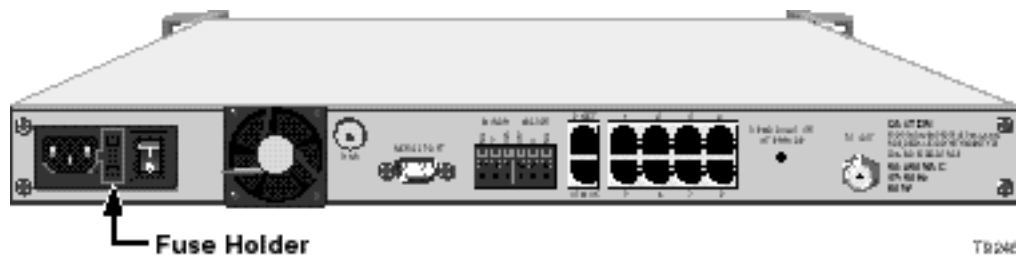

Note: The spare fuse in the fuse holder's hidden compartment should be retained as a backup. If you use this spare fuse, you should replace it.

2. Using a small flat-blade screwdriver, gently pry out the fuse holder.

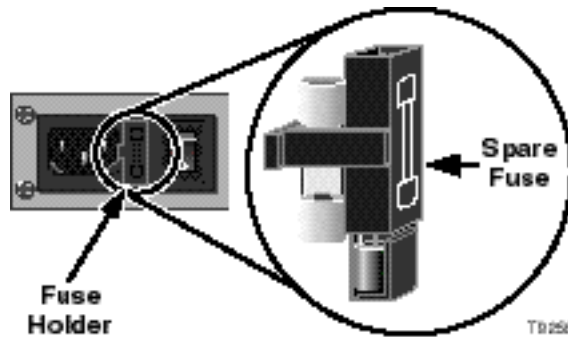

3. Remove the blown fuse and replace it with a new one.
4. Reinsert the fuse holder into the back panel.
5. Reconnect the power cord and power on the unit.

Chapter 4

Customer Information

If You Have Questions

If you have technical questions, call Cisco Services for assistance. Follow the menu options to speak with a service engineer.

Access your company's extranet site to view or order additional technical publications. For accessing instructions, contact the representative who handles your account. Check your extranet site often as the information is updated frequently.

Appendix A

Technical Specifications

Overview

Introduction

This appendix lists the electrical, operating, technical, and installation specifications for installing the QPSK Modulator.

In This Appendix

This appendix contains the following topics.

Topic	See Page
Electrical Specifications	A-2
Other Specifications	A-5

Electrical Specifications

Introduction

This section lists the power, RF, modulation, and connector type specifications for operating the QPSK Modulator.

Power Specifications

The following table lists the power specifications for the QPSK Modulator.

Item	Specification
Voltage (2 options)	<ul style="list-style-type: none">• Option 1: -42 V DC to -56.7 V DC• Option 2: 85 V AC to 264 V AC
Power	< 65 Watts

RF Specifications

The following table lists the RF specifications for the QPSK Modulator.

Item	Specification
Frequency Range	54 MHz to 550 MHz (center frequency)
Minimum Tuning Step Size	250 kHz
RF Output Power Level	+50 dBmV to +60 dBmV (minimum range)
RF Output Impedance	75 ohms
RF Output Return Loss	12 dB minimum (45 MHz to 550 MHz)
Occupied Bandwidth	1 MHz
Inband Spurious Outputs	<-57 dBc (50 MHz to 550 MHz)
Phase Noise	<-55 dBc/Hz 2 kHz from carrier Test to: -57 dBc <-75 dBc/Hz 10 kHz from carrier Test to: -77 dBc <-95 dBc/Hz 100 kHz from carrier Test to: -97 dBc
Noise Floor (out-of-band)	<-126 dBc/Hz > 25 MHz from center frequency
Output Power Level with Carrier Squelched	<0 dBmV
Output Power Level Stability	± 2 dB (over temperature)

Electrical Specifications, Continued

RF Specifications, Continued

Output Power Level Change	5 dB p-p max (over tuning range)
Output Frequency Error	< ± 10 ppm (over temperature)
RF Test Point Level	-20 dB (± 2 dB)

Modulation Specifications

The following table lists modulation specifications for the QPSK Modulator.

Item	Specification		
Modulation Type	QPSK		
Data Rate	1.544 Mbps		
Data Shaping Filter	Square root raised cosine; alpha = .30		
Spectral Mask	Offset from Center (MHz)	Response(dB)	
	0.5018	< -21	
	0.772	< -40	
Carrier Suppression	>30 dB		
Error Vector Magnitude for QPSK constellation, measured with HP89441 (or equivalent):	Typical: 2.0% rms Guaranteed: 3.0% rms Test to: 2.5% rms		
Differential Encoding	A	B	Phase Change
	0	0	none
	0	1	+90°
	1	1	180°
	1	0	-90°
	where A B are bits sequentially input to encoder (+ phase is counter clockwise rotation)		
Scrambler Polynomial	$X^6 + X^5 + 1$ (self synchronizing)		
Error Correction	Reed-Solomon; T = 1		

Electrical Specifications, Continued

Connector Type

The following table lists the Connector type specifications for the QPSK Modulator.

Item	Specification
RF Output	Type F
DC Input (Option 1 only)	Screw terminal
AC Input (Option 2 only)	3-prong male socket
RF Test Point	BNC
Ethernet 10/100BaseT	RJ-45
ATM 25	RJ-45 (9)
Alarm Relay	Quick insert wire connector
Alarm Contact Closures Contact Type Contact Rating	1 form C (NO, NC) contacts 220 V DC, 2 A switching

Other Specifications

Introduction

This section provides additional requirements, recommendations, rack specifications, and overall environmental specifications for the QPSK Modulator.

Frequency Requirements

The following list provides important frequency requirements.

- There must be 1 MHz of spectrum available within the range of 70 MHz to 130 MHz.
- The selected spectrum must be free of ingress, spurious, and spillover from other services.
- The Center frequency must be at 0.25 MHz increments starting with 70 MHz.

System Setting Recommendations

The following list provides important system setting recommendations.

- Analog/Digital Ratio at headend: 6 dB
- Analog/Digital Ratio at End of Line: <10 dB
- QPSK Level into DHCT: -10 dBmV to 10 dBmV
- C/N (1MHz BW): > 24 dB
- Amplitude Response in 1 MHz: <1 dB
- Delay Response in 1 MHz: <100 ns
- C/I >: 35 dB

Other Specifications, Continued

Rack Specifications

The following table lists the rack specifications for the QPSK Modulator.

Specification	Parameter
Height	1.75 in.
Width	19.00 in.
Depth	20.0 in.
Rack Mount Type	EIA RS-310

CAUTIONS:

- **Avoid damage to this product! Your warranty is void if you operate this product above the maximum specified operating temperature.**
- **Avoid damage to this product! Your warranty is void if you install this product without proper ventilation. Install 1U vent panels above and below each QPSK Modulator.**

Overall Environmental Specifications

The following table describes the environmental specifications for the QPSK Modulator.

Operating Temperature	0°C to 50°C (32°F to 122°F)
Operating Humidity	0% to 95% non-condensing
Vibration Susceptibility	No data errors with a chassis vibration of .5 Gs, with a vibration frequency of 10 Hz to 400 Hz
Electrostatic Shock Susceptibility	No damage from 5 discharges of 15 KV IEC model (150pF + 150 ohm) to all exposed connections

Glossary

Asynchronous Transfer Mode (ATM)	A digital switching and transport technology capable of supporting digitized voice, video, and packet data in standard fixed-length cells.
Bandwidth Segment	A reference to an analog transmission channel or a specific MPEG-2 Program carried using a digital transmission channel during some time interval.
BER	Bit Error Rate.
bps	Bits per second.
BFS	Broadcast File System.
BIG	See Broadband Integrated Gateway.
BOOTP	Bootstrap Protocol. This protocol determines the IP address of an Ethernet Interface. This is used by QAMs, MQAMS, QPSKs, and BIGs during the provisioning process.
Broadband	A communications system delivering multiple channels or services of video, voice, or data to users or subscribers over a broad band of the radio frequency spectrum.
Broadband Integrated Gateway (BIG)	The BIG provides an interface between networks providing digital video, audio, or data services and the DBDS. Multiplex transport device that provides interfaces to standard network transmission rates and types. Controls signal management for the DBDS. Terminates incoming ATM data streams from network servers, time-corrects the data, and passes them to QAM and MQAM modulator modems.
BSM - Broadcast Segment Manager (was Broadcast Service Manager).	The Broadcast Segment Manager is responsible for fielding broadcast segment definitions. It also receives notifications from the SI Manager when broadcast sources start and forwards those notifications for Conditional Access.
CA	Conditional Access. The process of securing a signal so that only authorized DHCTs will receive it.
CATV	Community Antenna Television (Cable Television).

Glossary, Continued

Combiner	Combines analog and digital video channels, QAM and MQAM, modulator video channels, and QPSK downstream control channels, and generate signals for delivery to DHCTs.
Content	Interactive television content: programs, catalogs, games, classes, videos, and other media.
CW	Carrier Wave, Continuous Wave, or Control Word.
Data stream	A general term used to describe any flow of digital data, such as audio, video, or control data, processed by the MPEG transport system.
DAVIC	Digital Audio Visual Council.
dB	Decibel. A unit for expressing the relative intensity of sounds or other signals.
DBDS	Digital Broadband Delivery System. The DBDS receives analog and digital services from various sources (i.e., analog and digital broadcast distribution systems, Wide Area Networks, and audio and video program servers). The DBDS coordinates the secure transport of these services over a network to DHCTs with reverse path requests initiated by the subscriber.
DHCT	Digital Home Communications Terminal.
Digital Broadcast Service	One or more events transmitted using a digital transmission channel without access control.
Digital Home Communications Terminal (DHCT)	A device that is connected to a television and a broadband interactive cable network system to receive and process digital and analog signals for television viewing and interactive television services.
Digital Network Control System (DNCS)	A family of software products and a graphical user interface (GUI) that allows the DBDS operator to manage and control the network and services support by the DBDS.

Glossary, Continued

Digital Pay-Per-View (PPV) Service	One or more encrypted PPV events transmitted using a digital transmission channel that may be decrypted by subscribers pre-authorized to receive the PPV events.
Digital Transmission Channel	A QAM MQAM waveform with a bandwidth of 6 MHz used for transporting an MPEG-2 Transport Stream from a headend to a DHCT. A digital transmission channel supports a data rate of 29.172 Mbps (after FEC) when modulated using 64-QAM, or 38.896 Mbps (after FEC) when modulated using 256-QAM.
Digital video compression	A method for increasing the amount of information that can be transmitted within the same bandwidth. Used for data that must be transmitted when sending a full-motion video signal from one location to another or when storing video. <i>Also see MPEG.</i>
Digital video service	A service offering video services through digital signal transmission including home shopping, banking, gaming, movies, and other applications.
DSM-CC	Digital Storage Media Command and Control (related to Data Carousel). A set of protocols that provides the control functions and operations specific to managing ISO/IEC 11172 (MPEG-1) and ISO/IEC 13818 (MPEG-2) bit streams.
DVB	Digital Video Broadcasting (European).
EMM	Entitlement Management Message.
Event	A unit of programming, such as a movie, an episode of a television show, a newscast, or a sports game. An event may also be a series of consecutive units of programming.
FDC	Forward Data Channel.
FEC	Forward Error Correction.

Glossary, Continued

Forward Data Channel	A QPSK waveform with a bandwidth of 1 MHz used for transporting data out-of-band from a hub to a DHCT. A forward data channel is capable of supporting a data rate of 1.544 Mbps.
Forward Path (out-of-band)	A physical connection from a hub to a DHCT. A forward path may support multiple analog transmission channels, digital transmission channels, and forward data channels.
FPGA	Field Programmable Gate Array.
Frequency	The number of similar shapes in a communications or electrical path in a unit of time. For example, the number of sine waves moving past a fixed point in one second.
Gateway	A computer system or any device that can transfer data between two normally compatible applications or networks. Also, a satellite earth station (dish).
Headend	See Network Elements.
HFC	Hybrid fiber/coax.
HITS	Headend In the Sky. A source of digital satellite programming received into the DBDS either by an IRD or an IRT.
Hybrid fiber/coax (HFC) network	A broadband network architecture that combines fiber trunk distribution of analog and digital signals with coaxial cable home access to deliver video, telephony, and data services.
Interactive Program Guide (IPG)	A service application that presents a schedule of services and service content information, such as the name, description, cast, and rating of a programming unit. The IPG also provides the Source identification of a selected service to another service application or DHCT operating system for tuning to the service.
IP	Internet Protocol.
IRT	Integrated Receiver Transcoder (third-party element of the Digital Video System).

Glossary, Continued

LED	Light-emitting diode.
LID	Land-Area-Network Interlock Device.
Mbps	Mega bits per second.
MHz	Mega-Hertz.
Moving Picture Experts Group (MPEG)	A set of international standards that define specifications for compressed video and audio and their combination and transport.
MPEG-2 TS	An international video compression standard supporting the interlaced video format used by the television industry and allowing a scaling of image quality and transmission bandwidth. Allows the capability for fixed and variable-bit rate video delivery.
MQAM	Multiplexing Quadrature Amplitude Modulator.
MSYNC	Master Synchronization – Clock signal.
Multiplexor (MUX)	A device that combines two or more independent signals into a single signal.
N/A	Not applicable.
Near-Video-On-Demand Service	A coordinated supply of encrypted NVOD events transmitted using multiple digital transmission channels which can only be decrypted by qualified subscribers who request authorization using the DHCT.
Network Elements	The electronic control switching or processing center for the cable network in a hybrid fiber/coax (HFC) network.
OC-3	Optical Carrier Level 3 OC-3 (capable of 155.52 Mbps).
Out-of-band	Cable technology in which data is sent through an addressable transmitter to subscribers on a separate RF carrier outside the normal 6 MHz band.

Glossary, Continued

Package	A set of one or more PowerKEY™-controlled events that is offered to subscribers for purchase.
Package Name	A descriptive name assigned to a package.
Packet	A data bundle packaged for transmission over a network.
Pay-Per-View (PPV) Event	An event with a defined start time and end time offered for purchase as part of a PPV service.
PDS	Packet Delivery System.
PES	Packetized Elementary Stream.
PID	Process Identification.
PSI	Program Specific Information.
QAM Modulator	The Quadrature Amplitude Modulation Modulator delivers digital broadcast and interactive services over noisy bands in the RF spectrum. QAM Modulator channels deliver compressed and encoded multiprogram MPEG transport streams containing interleaved voice, video, and data to DHCTs.
QPSK	Quadrature Phase-Shift Keying: DHCTs use QPSK for two-way signaling and messaging across an interactive TV network.
Reverse Data Channel	A QPSK waveform with a bandwidth of 1 MHz used for transporting data out-of-band from a DHCT to a hub.
Reverse Path	A physical connection from a DHCT to a hub. A reverse path may support multiple reverse data channels.
RF	Radio Frequency.
RS	Reed-Solomon (coding).

Glossary, Continued

Secure Digital Broadcast Service	One or more encrypted events transmitted using a digital transmission channel, which can only be decrypted by subscribers pre-authorized to receive the service.
Service Application	An application that facilitates the use of a service. Examples of service applications include a PPV application and an Interactive Program Guide.
SI	Service Information.
SMC	Status Monitoring and Control.
SONET	Synchronous Optical Network.
Source	An originator of one or more events.
Source ID	Uniquely identifies the source of one or more events.
SWIF	Single Wire Interface.
TCP	Transport Control Protocol.
TED	Transition Encryption Device.
TS	Transport Stream.
Two-Way Real-Time Datagram Service	A connectionless service (when an FDC is utilized) which routes IP datagrams from a VASP to a DHCT and from a DHCT to a VASP.
UN Config	User to Network Configuration (DNCS to DHCT configuration message).
VASP	Value-Added Service Provider (data sources and primary services delivery system).
Virtual Channel	A virtual channel provides an access path to an event by pointing to an analog transmission channel, a digital transmission channel, or a forward data channel where the service associated with the virtual channel can be found.
VOD	Video-On-Demand. An interactive application that provides a viewer with true pause, fast forward, and rewind operations using interaction between the DHCT and the video server.

Compliance

FCC Compliance

This equipment has been tested and found to comply with the limits for a Class A digital device, pursuant to Part 15 of FCC Rules. These limits provide reasonable protection against harmful interference when operating this equipment in a commercial environment.

This equipment generates, uses, and can radiate radio frequency energy and, if the user does not install and use this equipment according to the instruction manual, may cause harmful interference to radio communications.

Operation of this equipment in a residential area is likely to cause harmful interference, in which case the user will be required to correct the interference at his own expense.

Important: Install ferrite clamps on designated Ethernet cables and/or alarm relay cables (see instructions that came with the component).



CAUTION:

Any changes or modification to this equipment not expressly approved by Cisco could void the user's authority to operate this equipment.

Canadian EMI Regulation

“This Class A digital apparatus meets all requirements of the Canadian Interference Causing Equipment Regulations.”

“Cet appareil numérique de la classe A respecte toutes les exigences du Règlement sur le matériel brouilleur du Canada.”



Cisco Systems, Inc.
5030 Sugarloaf Parkway, Box 465447
Lawrenceville, GA 30042

678 277-1120
800 722-2009
www.cisco.com

This document includes various trademarks of Cisco Systems, Inc. Please see the Notices section of this document for a list of the Cisco Systems, Inc. trademarks used in this document.

Product and service availability are subject to change without notice.

© 2001, 2012 Cisco and/or its affiliates.

All rights reserved.

September 2012 Printed in USA

Part Number 78-545607-01 Rev D