









Prisma II 1550 nm Transmitters Installation and Configuration Guide

For Your Safety

Explanation of Warning and Caution Icons

Avoid personal injury and product damage! Do not proceed beyond any symbol until you fully understand the indicated conditions.

The following warning and caution icons alert you to important information about the safe operation of this product:

-  You may find this symbol in the document that accompanies this product. This symbol indicates important operating or maintenance instructions.
-  You may find this symbol affixed to the product. This symbol indicates a live terminal where a dangerous voltage may be present; the tip of the flash points to the terminal device.
-  You may find this symbol affixed to the product. This symbol indicates a protective ground terminal.
-  You may find this symbol affixed to the product. This symbol indicates a chassis terminal (normally used for equipotential bonding).
-  You may find this symbol affixed to the product. This symbol warns of a potentially hot surface.
-  You may find this symbol affixed to the product and in this document. This symbol indicates an infrared laser that transmits intensity-modulated light and emits invisible laser radiation or an LED that transmits intensity-modulated light.

Important

Please read this entire guide. If this guide provides installation or operation instructions, give particular attention to all safety statements included in this guide.

Notices

Trademark Acknowledgments

Cisco and the Cisco logo are trademarks or registered trademarks of Cisco and/or its affiliates in the U.S. and other countries. To view a list of cisco trademarks, go to this URL: www.cisco.com/go/trademarks.

Third party trademarks mentioned are the property of their respective owners.

The use of the word partner does not imply a partnership relationship between Cisco and any other company. (1110R)

Publication Disclaimer

Cisco Systems, Inc. assumes no responsibility for errors or omissions that may appear in this publication. We reserve the right to change this publication at any time without notice. This document is not to be construed as conferring by implication, estoppel, or otherwise any license or right under any copyright or patent, whether or not the use of any information in this document employs an invention claimed in any existing **or** later issued patent.

Copyright

© 2001, 2004, 2008-2009, 2012 Cisco and/or its affiliates. All rights reserved. Printed in the United States of America.

Information in this publication is subject to change without notice. No part of this publication may be reproduced or transmitted in any form, by photocopy, microfilm, xerography, or any other means, or incorporated into any information retrieval system, electronic or mechanical, for any purpose, without the express permission of Cisco Systems, Inc.

Contents

Important Safety Instructions	ix
Laser Safety	xix
Laser Power and Warning Labels	xxi
Chapter 1 Introduction	1
Description.....	3
Features	3
Operation	4
Optical Output	4
EMT Block Diagram	5
QAM Transmitter Block Diagram	5
The Front Panel	6
EMT Illustration	6
QAM Transmitter Illustration.....	7
The Back Panel	8
Back Panel Illustration	8
Back Panel Connectors	8
Configuration Overview	9
Configuration and Monitoring Methods.....	9
Configuration Summary	10
Chapter 2 Installation	11
Preparing for Installation.....	12
Unpacking and Inspecting the Module	12
Equipment and Tools Needed	12
Site Requirements	13
Access Requirements.....	13
Equipment Rack.....	13
Operating Environment.....	13
Power Requirements	14
Space Requirements.....	14
Chassis Style	14
Rear Access Chassis Illustration	14
Front Access Chassis Illustration.....	15

Connecting the RF Cables to the Chassis	16
To Connect RF Cables	16
Installing the Module in the Chassis.....	17
To Install the Module	17
Routing Optical Cables	19
Fiber Fish Tool.....	19
The Fiber Fish Tool Hook	19
To Pull the Optical Cable to the Module	20
Cleaning Optical Connectors	21
Recommended Equipment	21
Tips for Optimal Fiber Optic Connector Performance	21
To Clean Optical Connectors	22
Connecting Optical Cables	23
To Connect Optical Cables	23
Connecting the ICIM to Additional Chassis	24
ICIM IN and ICIM OUT Connectors.....	24
ICIM IN and ICIM OUT Cables.....	24
To Connect Chassis-to-Chassis ICIM IN and ICIM OUT Ports	25
Connecting the Chassis to the TNCS Server	26
To Connect TNCS to the Chassis EM IN Port.....	26
Using TNCS with Multiple Chassis	27
Making External Alarm Connections.....	28
ALARMS IN and ALARMS OUT Connections	28
ALARMS IN and ALARMS OUT Connector Illustration.....	29
Master/Slave Illustration.....	29
Redundancy Interface Panel.....	29
Prisma II Redundancy Interface Panel Illustrations	30

Chapter 3 Operation Using the ICIM 31

ICIM Introduction.....	32
ICIM Block Diagram.....	32
The ICIM Front Panel	33
ICIM Front Panel Illustration	33
ICIM Front Panel Features.....	34
ICIM2 LCD.....	34
ICIM Keypad	35
ICIM Password.....	36
Password Protection System	36
To Access the Password Menu.....	37
Expired Password or Inactive Password Messages	37
To Enter the User Password	38
To Change the User Password	39
To Disable the User Password using ICIM	40
Using the ICIM.....	41
To Adjust the LCD Contrast.....	41

To Access the MAIN Menu	41
To Access the ICIM Menu.....	42
MAIN and ICIM Menu Structures	43
Prisma II 1550 nm Long Reach and Extended Reach EMT (TXL,TXX) Software Menu Structure.....	44
Prisma II 1550 nm Full Height Reverse QAM (TXR) Transmitter Software Menu Structure.....	45
Checking the Operating Status using the ICIM.....	46
To Check Operating Status using the ICIM	46
STATUS Menus	47
Configuring the Module using the ICIM.....	48
To Configure Parameters using the ICIM	48
CONFIG Menus	49
Checking Alarms using the ICIM.....	50
To Check Alarms using the ICIM.....	50
To View Alarms	51
To Set Adjustable Alarm Thresholds using the ICIM.....	51
To Check Alarm Thresholds.....	52
Alarm Threshold Menus.....	52
Checking Manufacturing Data using the ICIM	53
To Check Manufacturing Data.....	53
MFG. DATA Menus	54
Saving the Configuration using the ICIM	55
To Save the Current Configuration	55
Configuration Complete	55
SNMP Configuration.....	56
SNMP Considerations.....	56
Basic SNMP Setup.....	56
To Set Up the IP Configuration Parameters for SNMP Support using ICIM.....	57
To Restart the ICIM by Removing the ICIM.....	58
Community Strings.....	59
Default Community Strings	59
Setting SNMP Trap Receiver Parameters	60
To Set Traps for a Specific IP Address using P2TrapRecvEntry	60
New SNMP Variables.....	61
Table of Inserted Modules	61
Table of Removed Modules.....	61
Previous IP Address	62
Boot Dialog for ICIM/SNMP Configuration	63
To Prepare to Change Parameters	64
To Change Parameters	65
To Restart the ICIM using ICIM	65
Adjusting Alarm Thresholds.....	66
To Adjust Alarm Thresholds.....	66

Chapter 4 Operation Using LCI 67

LCI Introduction	68
Laser Warning	68
LCI Function	68
System Requirements	69
Computer Requirements.....	69
Cable Requirements.....	69
Installing LCI	70
To Install the LCI Software	70
Connecting Your Computer to the Chassis.....	74
To Connect a Computer to the Chassis.....	74
Starting LCI Software	75
To Start LCI Software	75
LCI Module Tree	77
Introduction.....	77
Module Tree Levels	77
Accessing Module Details.....	78
Module Details Window	78
To Access the Module Details, Double-Click the Chassis.....	80
To Access the Module Details, Right-Click the Chassis	81
To Access the Module Details, Double-Click the Module	83
To Access the Module Details, Right-Click the Module.....	84
Checking the Operating Status	85
To Check the Operating Status using LCI.....	85
Configuring the Module using LCI.....	87
To Configure Parameters using LCI	87
Checking the Module Alarms using LCI.....	89
To Check Alarms using LCI	89
Modifying Module Alarm Limits using LCI.....	91
To Modify Alarm Limits using LCI.....	91
Checking Manufacturing Data using LCI	93
To Check Manufacturing Data using LCI	93

Chapter 5 Maintenance and Troubleshooting 95

Maintenance.....	96
Maintenance Record.....	96
General Troubleshooting Information.....	97
Equipment Needed.....	97
Additional Assistance	97
Troubleshooting	97
Troubleshooting Alarm Conditions	98
1550 nm EMT Transmitter (TXX, TXL) Alarm Conditions	98
1550 nm Reverse Transmitter (TXR) Alarm Conditions	99

Cleaning Optical Connectors	100
Recommended Equipment	100
Tips for Optimal Fiber Optic Connector Performance	100
To Clean Optical Connectors	101
Chapter 6 Customer Information	103
Appendix A Module Parameter Descriptions	105
1550 nm EMT Transmitter Parameters	106
Operating Status Parameters.....	106
Configurable Parameters	107
Alarm Data Parameters.....	108
Manufacturing Data Parameter Examples	109
1550 nm Reverse Transmitter Parameters	110
Operating Status Parameters.....	110
Configurable Parameters	110
Alarm Data Parameters.....	111
Manufacturing Data Parameter Examples	112
Glossary	113
Index	117

Important Safety Instructions

Read and Retain Instructions

Carefully read all safety and operating instructions before operating this equipment, and retain them for future reference.

Follow Instructions and Heed Warnings

Follow all operating and use instructions. Pay attention to all warnings and cautions in the operating instructions, as well as those that are affixed to this equipment.

Terminology

The terms defined below are used in this document. The definitions given are based on those found in safety standards.

Service Personnel - The term *service personnel* applies to trained and qualified individuals who are allowed to install, replace, or service electrical equipment. The service personnel are expected to use their experience and technical skills to avoid possible injury to themselves and others due to hazards that exist in service and restricted access areas.

User and Operator - The terms *user* and *operator* apply to persons other than service personnel.

Ground(ing) and Earth(ing) - The terms *ground(ing)* and *earth(ing)* are synonymous. This document uses *ground(ing)* for clarity, but it can be interpreted as having the same meaning as *earth(ing)*.

Electric Shock Hazard

This equipment meets applicable safety standards.



WARNING:

To reduce risk of electric shock, perform only the instructions that are included in the operating instructions. Refer all servicing to qualified service personnel only.

Electric shock can cause personal injury or even death. Avoid direct contact with dangerous voltages at all times. The protective ground connection, where provided, is essential to safe operation and must be verified before connecting the power supply.

Important Safety Instructions

Know the following safety warnings and guidelines:

- **Dangerous Voltages**
 - Only qualified service personnel are allowed to perform equipment installation or replacement.
 - Only qualified service personnel are allowed to remove chassis covers and access any of the components inside the chassis.
- **Grounding**
 - Do not violate the protective grounding by using an extension cable, power cable, or autotransformer without a protective ground conductor.
 - Take care to maintain the protective grounding of this equipment during service or repair and to re-establish the protective grounding before putting this equipment back into operation.

Installation Site

When selecting the installation site, comply with the following:

- **Protective Ground** - The protective ground lead of the building's electrical installation should comply with national and local requirements.
- **Environmental Condition** - The installation site should be dry, clean, and ventilated. Do not use this equipment where it could be at risk of contact with water. Ensure that this equipment is operated in an environment that meets the requirements as stated in this equipment's technical specifications, which may be found on this equipment's data sheet.

Installation Requirements



WARNING:

Allow only qualified service personnel to install this equipment. The installation must conform to all local codes and regulations.

Equipment Placement



WARNING:

Avoid personal injury and damage to this equipment. An unstable mounting surface may cause this equipment to fall.

To protect against equipment damage or injury to personnel, comply with the following:

- Install this equipment in a restricted access location.
- Do not install near any heat sources such as radiators, heat registers, stoves, or

other equipment (including amplifiers) that produce heat.

- Place this equipment close enough to a mains AC outlet to accommodate the length of this equipment's power cord.
- Route all power cords so that people cannot walk on, place objects on, or lean objects against them. This may pinch or damage the power cords. Pay particular attention to power cords at plugs, outlets, and the points where the power cords exit this equipment.
- Use only with a cart, stand, tripod, bracket, or table specified by the manufacturer, or sold with this equipment.
- Make sure the mounting surface or rack is stable and can support the size and weight of this equipment.
- The mounting surface or rack should be appropriately anchored according to manufacturer's specifications. Ensure this equipment is securely fastened to the mounting surface or rack where necessary to protect against damage due to any disturbance and subsequent fall.

Ventilation

This equipment has openings for ventilation to protect it from overheating. To ensure equipment reliability and safe operation, do not block or cover any of the ventilation openings. Install the equipment in accordance with the manufacturer's instructions.

Rack Mounting Safety Precautions

Mechanical Loading

Make sure that the rack is placed on a stable surface. If the rack has stabilizing devices, install these stabilizing devices before mounting any equipment in the rack.



WARNING:

Avoid personal injury and damage to this equipment. Mounting this equipment in the rack should be such that a hazardous condition is not caused due to uneven mechanical loading.

Reduced Airflow

When mounting this equipment in the rack, do not obstruct the cooling airflow through the rack. Be sure to mount the blanking plates to cover unused rack space. Additional components such as combiners and net strips should be mounted at the back of the rack, so that the free airflow is not restricted.



CAUTION:

Installation of this equipment in a rack should be such that the amount of airflow required for safe operation of this equipment is not compromised.

Important Safety Instructions

Elevated Operating Ambient Temperature

Only install this equipment in a humidity- and temperature-controlled environment that meets the requirements given in this equipment's technical specifications.



CAUTION:

If installed in a closed or multi-unit rack assembly, the operating ambient temperature of the rack environment may be greater than room ambient temperature. Therefore, install this equipment in an environment compatible with the manufacturer's maximum rated ambient temperature.

Handling Precautions

When moving a cart that contains this equipment, check for any of the following possible hazards:



WARNING:



Avoid personal injury and damage to this equipment! Move any equipment and cart combination with care. Quick stops, excessive force, and uneven surfaces may cause this equipment and cart to overturn.

- Use caution when moving this equipment/cart combination to avoid injury from tip-over.
- If the cart does not move easily, this condition may indicate obstructions or cables that may need to be disconnected before moving this equipment to another location.
- Avoid quick stops and starts when moving the cart.
- Check for uneven floor surfaces such as cracks or cables and cords.

Grounding

This section provides instructions for verifying that the equipment is properly grounded.

Safety Plugs (USA Only)

This equipment may be equipped with either a 3-terminal (grounding-type) safety plug or a 2-terminal (polarized) safety plug. The wide blade or the third terminal is provided for safety. Do not defeat the safety purpose of the grounding-type or polarized safety plug.

To properly ground this equipment, follow these safety guidelines:

- **Grounding-Type Plug** - For a 3-terminal plug (one terminal on this plug is a protective grounding pin), insert the plug into a grounded mains, 3-terminal outlet.

Note: This plug fits only one way. If this plug cannot be fully inserted into the outlet, contact an electrician to replace the obsolete 3-terminal outlet.

- **Polarized Plug** - For a 2-terminal plug (a polarized plug with one wide blade and one narrow blade), insert the plug into a polarized mains, 2-terminal outlet in which one socket is wider than the other.

Note: If this plug cannot be fully inserted into the outlet, try reversing the plug. If the plug still fails to fit, contact an electrician to replace the obsolete 2-terminal outlet.

Grounding Terminal

If this equipment is equipped with an external grounding terminal, attach one end of an 18-gauge wire (or larger) to the grounding terminal; then, attach the other end of the wire to a ground, such as a grounded equipment rack.

Safety Plugs (European Union)

- **Class I Mains Powered Equipment** – Provided with a 3-terminal AC inlet and requires connection to a 3-terminal mains supply outlet via a 3-terminal power cord for proper connection to the protective ground.

Note: The equipotential bonding terminal provided on some equipment is not designed to function as a protective ground connection.

- **Class II Mains Powered Equipment** – Provided with a 2-terminal AC inlet that may be connected by a 2-terminal power cord to the mains supply outlet. No connection to the protective ground is required as this class of equipment is provided with double or reinforced and/or supplementary insulation in addition to the basic insulation provided in Class I equipment.

Note: Class II equipment, which is subject to EN 50083-1, is provided with a chassis mounted equipotential bonding terminal. See the section titled **Equipotential Bonding** for connection instructions.

Equipotential Bonding

If this equipment is equipped with an external chassis terminal marked with the IEC 60417-5020 chassis icon () , the installer should refer to CENELEC standard EN 50083-1 or IEC standard IEC 60728-11 for correct equipotential bonding connection instructions.

AC Power

Important: If this equipment is a Class I equipment, it must be grounded.

- If this equipment plugs into an outlet, the outlet must be near this equipment, and must be easily accessible.
- Connect this equipment only to the power sources that are identified on the equipment-rating label normally located close to the power inlet connector(s).

Important Safety Instructions

- This equipment may have two power sources. Be sure to disconnect all power sources before working on this equipment.
- If this equipment **does not** have a main power switch, the power cord connector serves as the disconnect device.
- Always pull on the plug or the connector to disconnect a cable. Never pull on the cable itself.
- Unplug this equipment when unused for long periods of time.

Connection to -48 V DC/-60 V DC Power Sources

If this equipment is DC-powered, refer to the specific installation instructions in this manual or in companion manuals in this series for information on connecting this equipment to nominal -48 V DC/-60 V DC power sources.

Circuit Overload

Know the effects of circuit overloading before connecting this equipment to the power supply.



CAUTION:

Consider the connection of this equipment to the supply circuit and the effect that overloading of circuits might have on overcurrent protection and supply wiring. Refer to the information on the equipment-rating label when addressing this concern.

General Servicing Precautions



WARNING:

Avoid electric shock! Opening or removing this equipment's cover may expose you to dangerous voltages.



CAUTION:

These servicing precautions are for the guidance of qualified service personnel only. To reduce the risk of electric shock, do not perform any servicing other than that contained in the operating instructions unless you are qualified to do so. Refer all servicing to qualified service personnel.

Be aware of the following general precautions and guidelines:

- **Servicing** - Servicing is required when this equipment has been damaged in any way, such as power supply cord or plug is damaged, liquid has been spilled or objects have fallen into this equipment, this equipment has been exposed to rain or moisture, does not operate normally, or has been dropped.

- **Wristwatch and Jewelry** - For personal safety and to avoid damage of this equipment during service and repair, do not wear electrically conducting objects such as a wristwatch or jewelry.
- **Lightning** - Do not work on this equipment, or connect or disconnect cables, during periods of lightning.
- **Labels** - Do not remove any warning labels. Replace damaged or illegible warning labels with new ones.
- **Covers** - Do not open the cover of this equipment and attempt service unless instructed to do so in the instructions. Refer all servicing to qualified service personnel only.
- **Moisture** - Do not allow moisture to enter this equipment.
- **Cleaning** - Use a damp cloth for cleaning.
- **Safety Checks** - After service, assemble this equipment and perform safety checks to ensure it is safe to use before putting it back into operation.

Electrostatic Discharge

Electrostatic discharge (ESD) results from the static electricity buildup on the human body and other objects. This static discharge can degrade components and cause failures.

Take the following precautions against electrostatic discharge:

- Use an anti-static bench mat and a wrist strap or ankle strap designed to safely ground ESD potentials through a resistive element.
- Keep components in their anti-static packaging until installed.
- Avoid touching electronic components when installing a module.

Fuse Replacement

To replace a fuse, comply with the following:

- Disconnect the power before changing fuses.
- Identify and clear the condition that caused the original fuse failure.
- Always use a fuse of the correct type and rating. The correct type and rating are indicated on this equipment.

Batteries

This product may contain batteries. Special instructions apply regarding the safe use and disposal of batteries:

Important Safety Instructions

Safety

- Insert batteries correctly. There may be a risk of explosion if the batteries are incorrectly inserted.
- Do not attempt to recharge 'disposable' or 'non-reusable' batteries.
- Please follow instructions provided for charging 'rechargeable' batteries.
- Replace batteries with the same or equivalent type recommended by manufacturer.
- Do not expose batteries to temperatures above 100°C (212°F).

Disposal

- The batteries may contain substances that could be harmful to the environment
- Recycle or dispose of batteries in accordance with the battery manufacturer's instructions and local/national disposal and recycling regulations.



廢電池請回收

- The batteries may contain perchlorate, a known hazardous substance, so special handling and disposal of this product might be necessary. For more information about perchlorate and best management practices for perchlorate-containing substance, see www.dtsc.ca.gov/hazardouswaste/perchlorate.

Modifications

This equipment has been designed and tested to comply with applicable safety, laser safety, and EMC regulations, codes, and standards to ensure safe operation in its intended environment. Refer to this equipment's data sheet for details about regulatory compliance approvals.

Do not make modifications to this equipment. Any changes or modifications could void the user's authority to operate this equipment.

Modifications have the potential to degrade the level of protection built into this equipment, putting people and property at risk of injury or damage. Those persons making any modifications expose themselves to the penalties arising from proven non-compliance with regulatory requirements and to civil litigation for compensation in respect of consequential damages or injury.

Accessories

Use only attachments or accessories specified by the manufacturer.

Electromagnetic Compatibility Regulatory Requirements

This equipment meets applicable electromagnetic compatibility (EMC) regulatory requirements. Refer to this equipment's data sheet for details about regulatory compliance approvals. EMC performance is dependent upon the use of correctly shielded cables of good quality for all external connections, except the power source, when installing this equipment.

- Ensure compliance with cable/connector specifications and associated installation instructions where given elsewhere in this manual.

Otherwise, comply with the following good practices:

- Multi-conductor cables should be of single-braided, shielded type and have conductive connector bodies and backshells with cable clamps that are conductively bonded to the backshell and capable of making 360° connection to the cable shielding. Exceptions from this general rule will be clearly stated in the connector description for the excepted connector in question.
- Ethernet cables should be of single-shielded or double-shielded type.
- Coaxial cables should be of the double-braided shielded type.

EMC Compliance Statements

Where this equipment is subject to USA FCC and/or Industry Canada rules, the following statements apply:

FCC Statement for Class A Equipment

This equipment has been tested and found to comply with the limits for a Class A digital device, pursuant to Part 15 of the FCC Rules. These limits are designed to provide reasonable protection against harmful interference when this equipment is operated in a commercial environment.

This equipment generates, uses, and can radiate radio frequency energy and, if not installed and used in accordance with the instruction manual, may cause harmful interference to radio communications. Operation of this equipment in a residential area is likely to cause harmful interference in which case users will be required to correct the interference at their own expense.

Industry Canada - Industrie Canadienne Statement

This apparatus complies with Canadian ICES-003.
Cet appareil est conforme à la norme NMB-003 du Canada.

CENELEC/CISPR Statement with Respect to Class A Information Technology Equipment

This is a Class A equipment. In a domestic environment this equipment may cause radio interference in which case the user may be required to take adequate measures.

Laser Safety

Introduction

This equipment contains an infrared laser that transmits intensity-modulated light and emits invisible radiation.

Warning: Radiation



WARNING:

- **Avoid personal injury! Use of controls, adjustments, or procedures other than those specified herein may result in hazardous radiation exposure.**
 - **Avoid personal injury! The laser light source on this equipment (if a transmitter) or the fiber cables connected to this equipment emit invisible laser radiation. Avoid direct exposure to the laser light source.**
 - **Avoid personal injury! Viewing the laser output (if a transmitter) or fiber cable with optical instruments (such as eye loupes, magnifiers, or microscopes) may pose an eye hazard.**
- Do not apply power to this equipment if the fiber is unmated or unterminated.
 - Do not stare into an unmated fiber or at any mirror-like surface that could reflect light emitted from an unterminated fiber.
 - Do not view an activated fiber with optical instruments such as eye loupes, magnifiers, or microscopes.
 - Use safety-approved optical fiber cable to maintain compliance with applicable laser safety requirements.

Warning: Fiber Optic Cables



WARNING:

Avoid personal injury! Qualified service personnel may only perform the procedures in this manual. Wear safety glasses and use extreme caution when handling fiber optic cables, particularly during splicing or terminating operations. The thin glass fiber core at the center of the cable is fragile when exposed by the removal of cladding and buffer material. It easily fragments into glass splinters. Using tweezers, place splinters immediately in a sealed waste container and dispose of them safely in accordance with local regulations.

Safe Operation for Software Controlling Optical Transmission Equipment

If this manual discusses software, the software described is used to monitor and/or control ours and other vendors' electrical and optical equipment designed to transmit video, voice, or data signals. Certain safety precautions must be observed when operating equipment of this nature.

For equipment specific safety requirements, refer to the appropriate section of the equipment documentation.

For safe operation of this software, refer to the following warnings.



WARNING:

- **Ensure that all optical connections are complete or terminated before using this equipment to remotely control a laser device. An optical or laser device can pose a hazard to remotely located personnel when operated without their knowledge.**
- **Allow only personnel trained in laser safety to operate this software. Otherwise, injuries to personnel may occur.**
- **Restrict access of this software to authorized personnel only.**
- **Install this software in equipment that is located in a restricted access area.**

Laser Power and Warning Labels

Warning Labels

The following labels are located on this product.

Laser Warning Label



Laser Classification Label

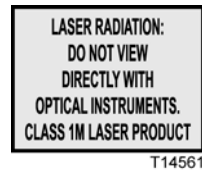

Product and Laser Information Label

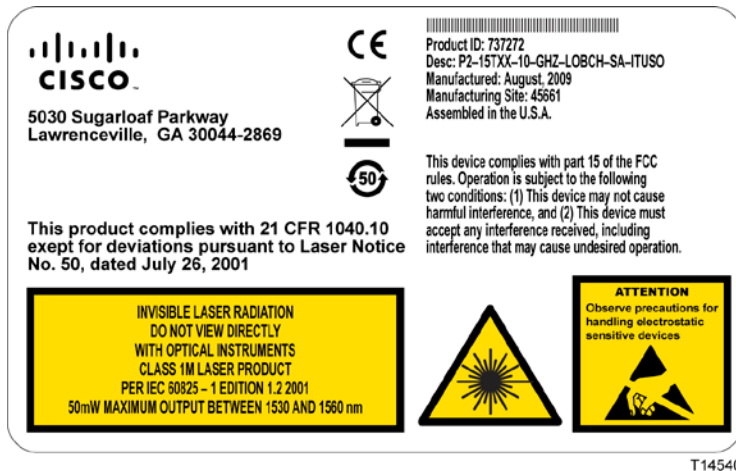

Location of Labels on Equipment

The following illustrations display the location of warning labels on this equipment.

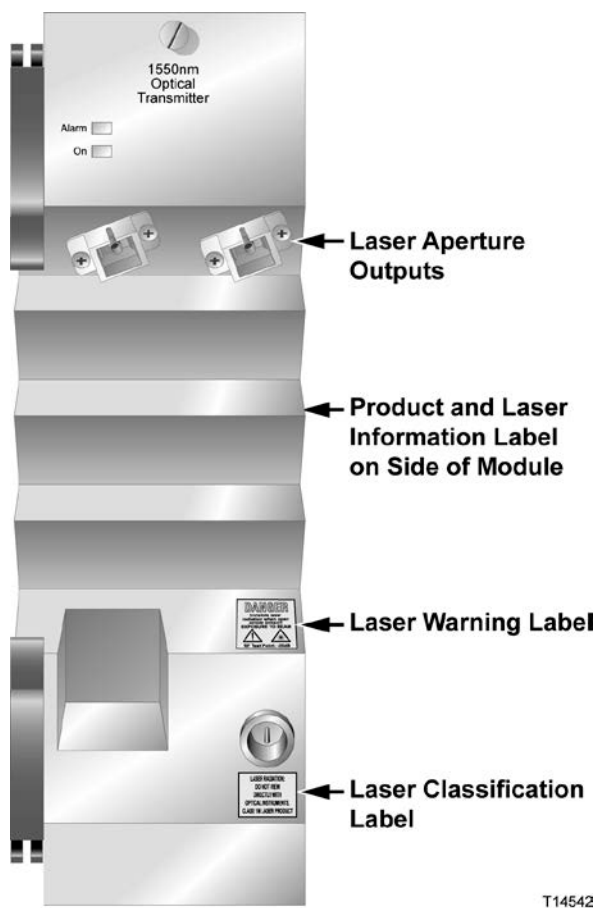
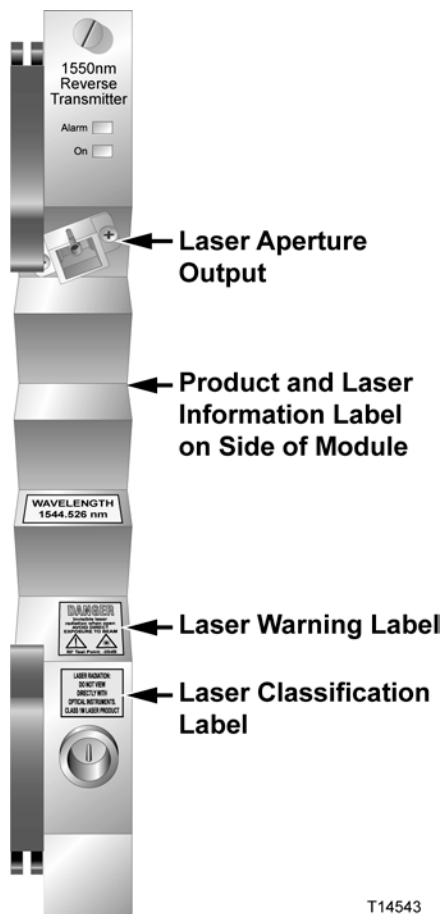

1

Introduction

Overview

This chapter describes the Prisma® II 1550 nm Transmitters.

Purpose

This guide provides information about the Prisma II 1550 nm Transmitters. It describes the front and back panels and presents a setup summary for the transmitters.

Who Should Use This Document

This document is intended for authorized service personnel who have experience working with similar equipment. The service personnel should have appropriate background and knowledge to complete the procedures described in this document.

Qualified Personnel

Only appropriately qualified and skilled personnel should attempt to install, operate, maintain, and service this product.



WARNING:

Only appropriately qualified and skilled personnel should attempt to install, operate, maintain, and service this product. Otherwise, personal injury or equipment damage may occur.

Scope

This guide discusses the following topics.

- Description of the transmitters
- Installation procedures
- Operation using the ICIM
- Operation using LCI
- Maintenance and troubleshooting

Document Version

This is the sixth release of this guide (Rev F).

In This Chapter

■ Description.....	3
■ The Front Panel	6
■ The Back Panel	8
■ Configuration Overview	9

Description

The Prisma II optical network is an advanced transmission system designed to optimize network architectures and increase reliability, scalability, and cost-effectiveness. The Prisma II 1550 nm Externally Modulated Transmitters (EMTs) are plug-in modules for the Prisma II platform. Microprocessor control allows ease of installation and flexibility of application.

The transmitter design includes an array of capabilities, such as low RF input level, broadcast, and elective Automatic Gain Control (AGC). AGC is a feature of the 1550 nm EMTs.

The Prisma II 1550 nm Transmitters covered in this guide include the following:

- Long Reach EMT, PII-15TXL
- Extended Reach EMT, PII-15TXX
- Full Height Reverse Quadrature Amplitude Modulated (QAM) Transmitter, PII-15TXR

Features

The Prisma II 1550 nm Transmitters have the following features:

- Front panel green light emitting diode (LED) to indicate operating status
- Front panel red LED to indicate alarm status
- -20 dB test point
- Optical output connector(s)
- Plug-and-play capability
- Compatible with Intelligent Communications Interface Module (ICIM), Local Craft Interface (LCI) software, and Transmission Networks Control System (TNCS) software
- Blind-mate radio frequency (RF) connections

Operation

The Prisma II 1550 nm Transmitters receive an RF signal through a connector on the rear of the module. The RF input signal is then amplified and converted to an optical signal. This module employs a high-performance, doubly isolated distributed feedback (DFB) laser to generate the optical signal.

First, the incoming RF signal is amplified. The signal is routed through a coupler and is sent to an RF detector circuit. The detector circuit produces a DC voltage that is proportional to the incident RF power. This voltage level is used to monitor the input power level. The transmitter will generate an alarm condition if the input power is over or under a specified level.

If necessary, an attenuator is used to reduce RF power in an overdrive condition, or to compensate for gain variations of the transmitter. The signal is equalized, then impedance-matched, then sent to the laser. The optical output connector is located on the front panel of the module.

The user can turn the laser on or off, adjust the drive level to the laser, and set alarm levels. The module is controlled by an ICIM, the LCI software, or the TNCS software.

Optical Output

Depending on how you ordered your system, the optical output connectors may either be an SC/APC, SC/UPC, FC/UPC, or E2000/APC.



WARNING:

Avoid damage to your eyes! Do not look into any optical connector while the system is active. Even if the unit is off, there may still be hazardous optical levels present.

EMT Block Diagram

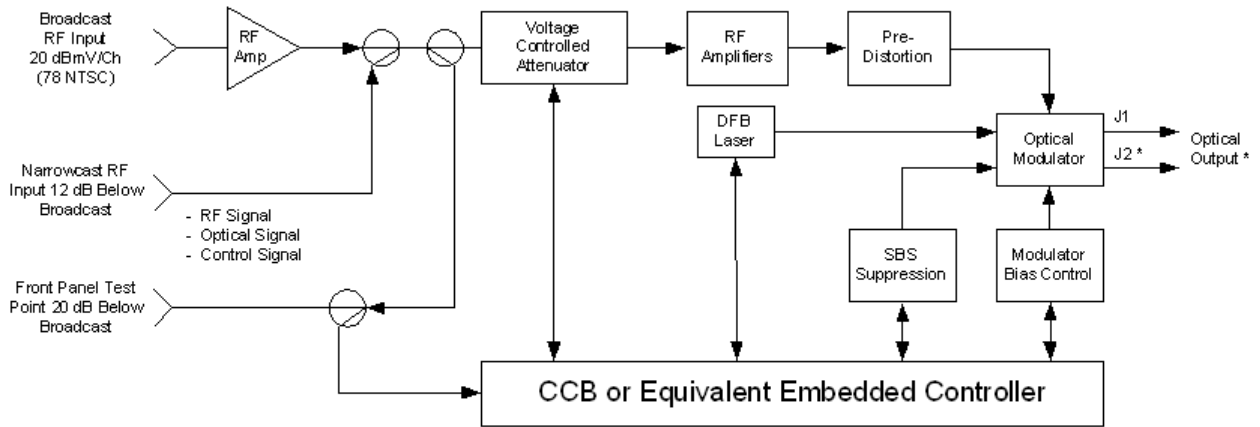

* Dual optical outputs, J1 and J2, on a P2-15TXL Transmitter
 Single optical output, J1 only, on a P2-15TXX Transmitter

TP625

QAM Transmitter Block Diagram

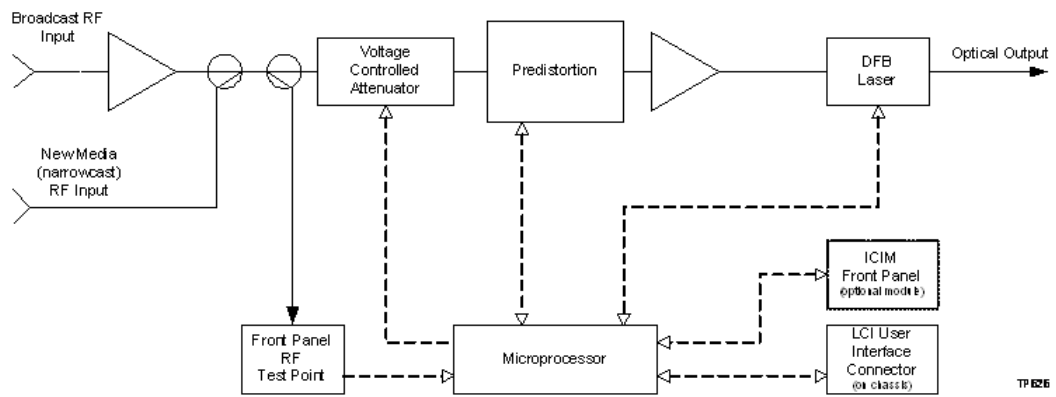

TP626

The Front Panel

The following table lists the features of the Prisma II 1550 nm Transmitter front panel.

Feature	Description
Alarm indicator	Illuminates or blinks when an alarm condition occurs.
Power On indicator	Illuminates when power is supplied to the module.
Optical output	Connects the output signal to the optical cable.
-20 dB test point	Provides a -20 dB sample of the RF input signal.

EMT Illustration

The front panel of the Prisma II 1550 nm EMT is shown below. The PII-15TXL is a two-port device, while PII-15TXX is a one-port device.

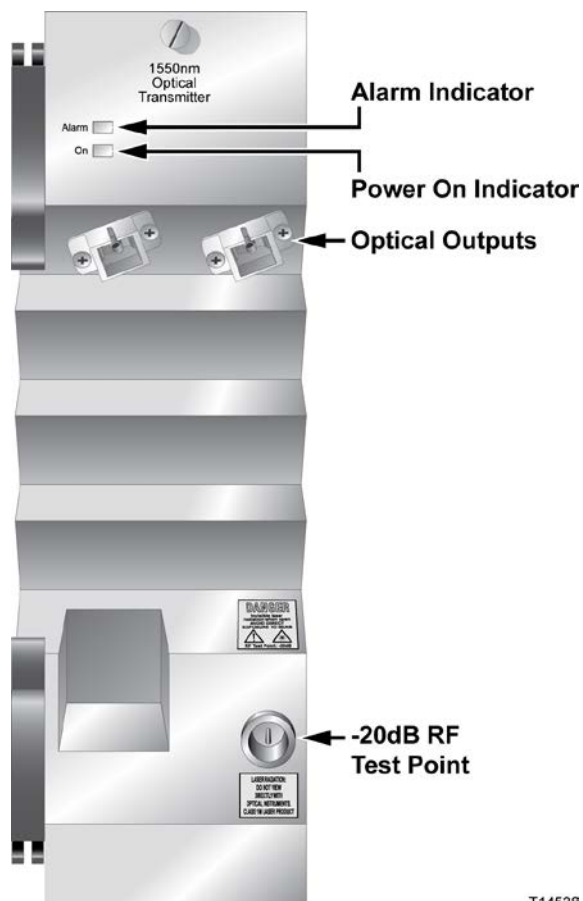

T14538

QAM Transmitter Illustration

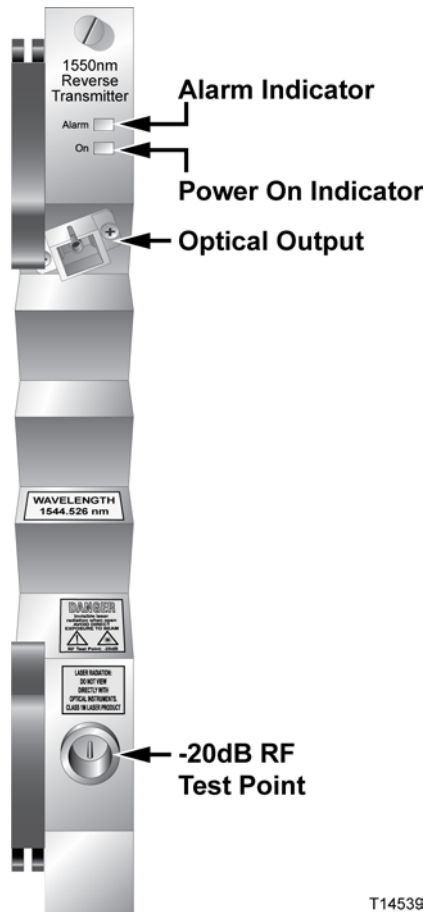

T14539

The Back Panel

Back Panel Illustration

The back panel of the module is shown below.

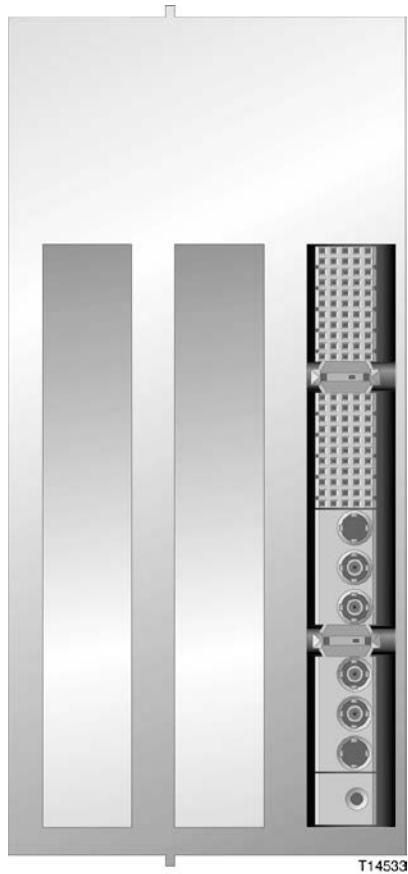

Back Panel Connectors

Blind-mate connectors make it easy to install this module. The power and communications connector on the back of the module mates with the backplane connector inside of the chassis. This 110-pin connector provides the following:

- RF signal input connection
- Electrical power input connection
- Alarm communications
- Status-monitoring communications
- Communications and control connections

Configuration Overview

The Prisma II 1550 nm Transmitter ships from the factory with operational parameters set to factory defaults. However, you will probably choose to configure the operating parameters so that they are best suited for your application.

Configuration and Monitoring Methods

Prisma II 1550 nm Transmitters may be controlled using any of the following methods.

- Prisma II ICIM

If an ICIM is installed in the Prisma II Chassis, it may be used to configure and monitor Prisma II application modules within its domain. For instructions on operating this module using the ICIM, refer to *Operation Using the ICIM* (on page 31).

- LCI software

The Local Craft Interface (LCI) software running on a locally connected PC may be used to configure operating parameters of Prisma II modules. For instructions on operating this module using the LCI software, refer to *Operation Using LCI* (on page 67).

- TNCS software

If the ICIM is installed, TNCS software may be used to configure and monitor all functions of the Prisma II modules. For instructions on operating this module using TNCS, see the manual that was shipped with the TNCS software.

Configuration Summary

Using any of the above methods, you can configure the following parameters.

- Enable Laser
- Laser Mode
- AGC
- RF Drive Level to the Laser
- Optical Modulation Index (OMI) Level
- Master/Slave Mode
- RFLasSet
- Length
- LowRF Alarm Inhibit

Configurable parameters are dependent on the type of transmitter. For detailed information on configuring this module, see *Operation Using the ICIM* (on page 31) or *Operation Using LCI* (on page 67).

2

Installation

This chapter provides instructions and identifies the site requirements, tools, and equipment needed to install this module.

Qualified Personnel



WARNING:

Allow only qualified personnel to install, operate, maintain, or service this product. Otherwise, personal injury or equipment damage may occur.

In This Chapter

■ Preparing for Installation.....	12
■ Site Requirements	13
■ Connecting the RF Cables to the Chassis	16
■ Installing the Module in the Chassis.....	17
■ Routing Optical Cables	19
■ Cleaning Optical Connectors	21
■ Connecting Optical Cables	23
■ Connecting the ICIM to Additional Chassis	24
■ Connecting the Chassis to the TNCS Server	26
■ Making External Alarm Connections.....	28

Preparing for Installation

Before you begin, make sure that the module is in good condition and that you have the tools and equipment listed here.

Unpacking and Inspecting the Module

As you unpack the module, inspect it for shipping damage. If you find any damage, contact Cisco Services. Refer to *Customer Information* (on page 103) for contact information.

Equipment and Tools Needed

Before you begin, make sure that the module is in good condition. You need the following equipment and tools to install these modules.

You need . . .	To . . .
A standard Prisma II Chassis with power supply	Provide housing, power, and input and output connections to the module.
A 3/8-in. flat-blade screwdriver	Secure the module in the chassis.
A 7/16-in. open-end wrench	Secure RF cable connectors at the chassis.
One RF cable with connectors	Carry RF input signals.

Site Requirements

Before you begin, be sure that your installation site meets the requirements discussed in this section.

Access Requirements

Ensure that only authorized personnel have access to this equipment. Otherwise, personal injury or equipment damage may occur.



WARNING:

Use this product in locations that restrict access to all persons who are not authorized. Otherwise, personal injury or equipment damage may occur.

Equipment Rack

To install the modules, your site should be equipped with an Electronics Industry Association (EIA) equipment rack that properly houses the Prisma II Chassis with proper spacing for air circulation. For instructions on installing the chassis in the rack, refer to the guide that was shipped with the chassis.

Operating Environment



CAUTION:

Avoid damage to this product! Operating this product outside the specified operating temperature limits voids the warranty.

Follow these recommendations to maintain an acceptable operating temperature:

- Temperature inside the rack must be between -40°C and 65°C (-40°F and 149°F)
- Keep cooling vents clear and free of obstructions.
- Provide ventilation, as needed, using one or more of the following methods.
 - Air-deflecting baffles
 - Forced-air ventilation
 - Air outlets above enclosures

Power Requirements

Prisma II modules receive their electrical power from the Prisma II Chassis. The module may be installed with the chassis under power.

Space Requirements

The Prisma II 1550 nm EMT Transmitters are triple-width modules. The Prisma II 1550 nm Reverse QAM Transmitter is a single-width module. These modules are usually installed in slots 5 through 16. Slots 1 through 4 are usually reserved for the power supplies.

Slots 15 and 16 are reserved for the ICIM, if installed. If an ICIM is not installed, any other module could be installed in these slots. Slot 2 and slot 4 are reserved for an internal power supply if installed. If an internal power supply is not installed here, any other module could be installed in these slots.

Chassis Style

The Prisma II Chassis may be configured with front or rear connectors depending on the system you have purchased. Power, RF input/output, and other connectors may be located on either the front or rear of the Prisma II Chassis. Connections to the chassis serve the same function and are made in the same manner regardless of the location of the connectors or chassis configuration.

Rear Access Chassis Illustration

The rear access chassis is shown here.

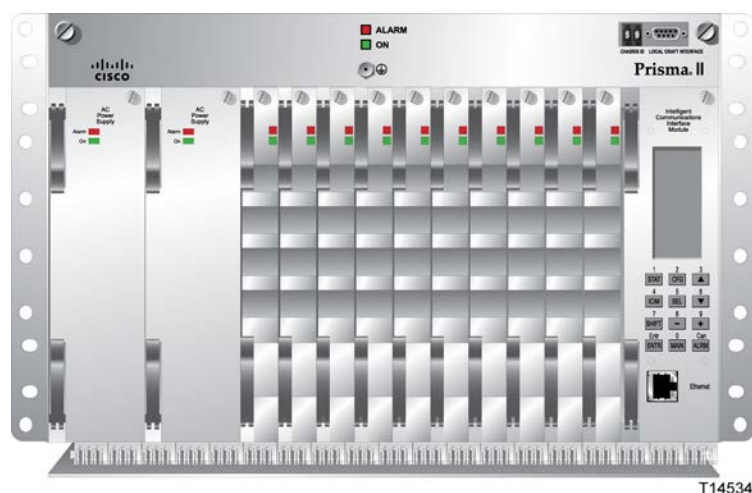

Front Access Chassis Illustration

The front access chassis is shown here.

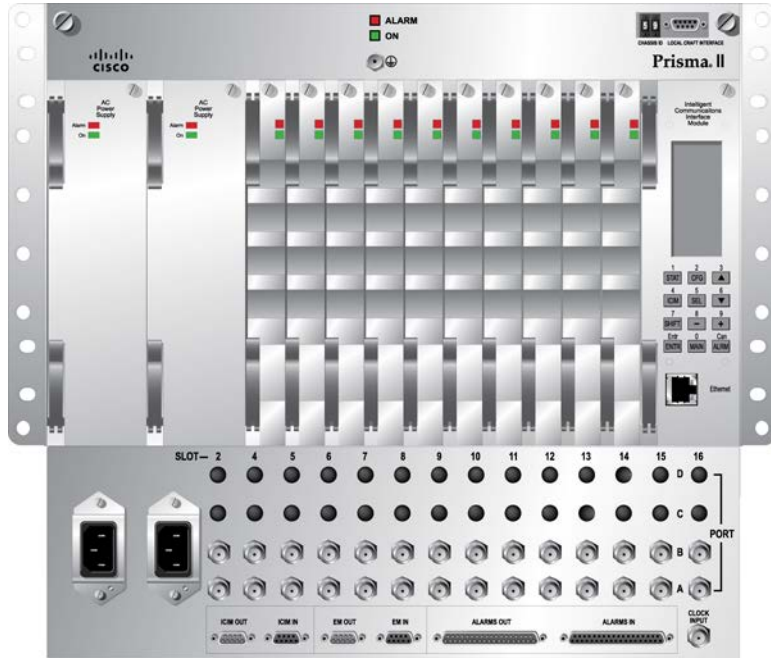

T14535

Connecting the RF Cables to the Chassis

Important: This procedure assumes the Prisma II Chassis is mounted in a rack.

To Connect RF Cables

Complete the following steps to make the RF cable connections for each transmitter to be installed.

- 1 Attach a 75-ohm RF cable to the appropriate RF source.
- 2 At the front/rear of the Prisma II Chassis, locate the RF ports.

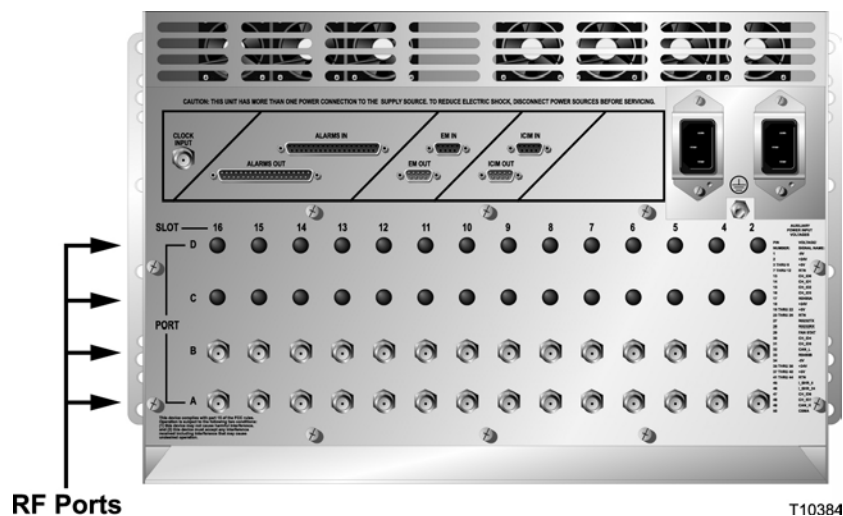

- 3 Attach the other end of the RF cable to Port A connector (RF IN) of the corresponding slot where the module is to be installed. This is the RF input connection.

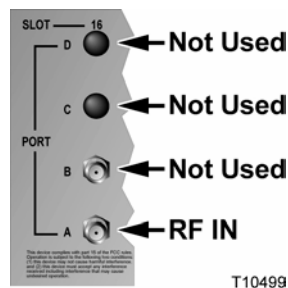

- 4 If F-connectors are installed, use a 7/16-in. open-end wrench to secure both cables to the connectors at the chassis.

Installing the Module in the Chassis

Important:

- The following procedure assumes that the Prisma II Chassis is mounted in a rack.
- This procedure applies to both front access and rear access chassis styles. This module is usually installed in slots 5 through 16.

To Install the Module



WARNING:

Avoid damage to your eyes! Do not look into any optical connector while the system is active. Even if the unit is off, there may still be hazardous optical levels present.

Complete the following steps to install the module in the chassis.

- 1 Locate the fiber guides at the bottom of the chassis and the module guide slots inside the chassis as shown in the following illustration.

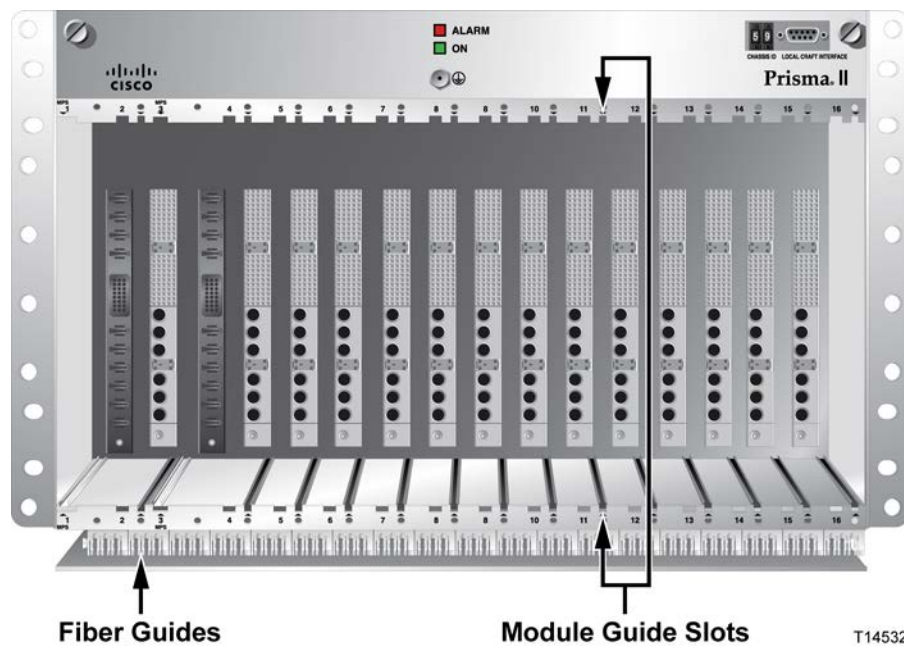

- 2 Align the ridges on the top and bottom of the module with the module guide slots located on the chassis. Module ejectors must be fully extended when inserting the module.

- 3 Gently slide the module into the chassis until you feel the connectors on the back of the module join the receptacles at the back of the slot. Use the module ejector to lock the module in place.

Note: Do not force or bang the module into the chassis. If properly aligned, it will slide in with minimal force.

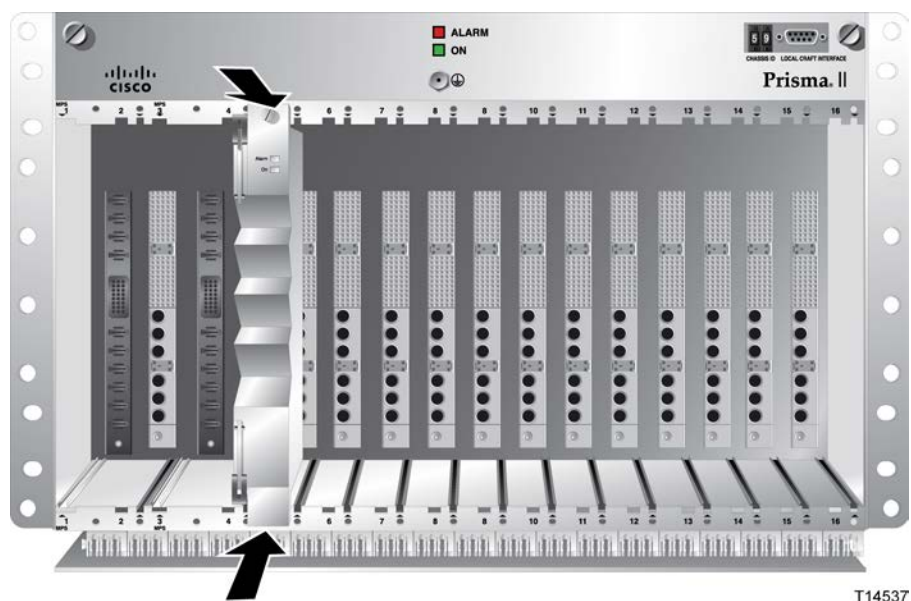

- 4 Secure the module by pressing the two ejectors located on the left side of the module until they lock. When the levers are locked, the power and communications connections at the rear of the module mates with the communications connectors at the back of the chassis slot.
- 5 Hand-tighten the screw at the top of the module to secure it in the chassis. Use a 3/8-in. flat-blade screwdriver to secure. Do not over-tighten.

Routing Optical Cables

Before connecting fiber optic cables, you may need to route the fiber to the module. Use the tools and procedures in this section to route fiber as needed.

Fiber Fish Tool

**WARNING:**

Unterminated fiber cables and connectors may emit invisible laser radiation. Avoid direct exposure to the laser light source. Ensure that the fiber cable is terminated before "fishing."

The Fiber Fish tool that was shipped with the Prisma II Chassis is used to pull an optical cable from the rear of the chassis to the front of the chassis so the optical cables can be connected to optical connectors on the front panel of the modules.



The Fiber Fish Tool Hook

At the end of the Fiber Fish tool is a small hook that allows you to hold an optical cable so that you can pull it through to the front panel of chassis.

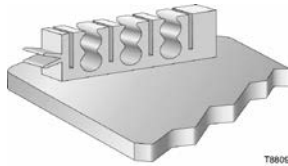

To Pull the Optical Cable to the Module

- 1 Insert the Fiber Fish tool through the slot located just above the bottom of the chassis.
- 2 At the rear of the chassis, locate the appropriate optical cable.
- 3 Insert the optical cable into the notched area of the Fiber Fish tool as shown below.

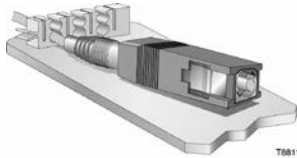

- 4 At the front of the chassis, pull the Fiber Fish tool (with cable attached) to the front of the chassis.
- 5 Disengage the optical cable from the Fiber Fish tool and attach to the appropriate connector on the desired module.

Cleaning Optical Connectors

**CAUTION:**

Proper operation of this equipment requires clean optical fibers. Dirty fibers will adversely affect performance. Proper cleaning is imperative.

The proper procedure for cleaning optical connectors depends on the connector type. The following describes general instructions for fiber optic cleaning. Use your company's established procedures, if any, but also consider the following.

Cleaning fiber optic connectors can help prevent interconnect problems and aid system performance. When optical connectors are disconnected or reconnected, the fiber surface can become dirty or scratched, reducing system performance.

Inspect connectors prior to mating, clean as needed, and then remove all residue. Inspect connectors after cleaning to confirm that they are clean and undamaged.

Recommended Equipment

- CLETOP or OPTIPOP ferrule cleaner (for specific connector type)
- Compressed air (also called “canned air”)
- Lint-free wipes moistened with optical-grade (99%) isopropyl alcohol
- Bulkhead swabs (for specific connector type)
- Optical connector scope with appropriate adaptor

Tips for Optimal Fiber Optic Connector Performance

- Do not connect or disconnect optical connectors with optical power present.
- Always use compressed air before cleaning the fiber optic connectors and when cleaning connector end caps.
- Always install or leave end caps on connectors when they are not in use.
- If you have any degraded signal problems, clean the fiber optic connector.
- Advance a clean portion of the ferrule cleaner reel for each cleaning.
- Turn off optical power before making or breaking optical connections to avoid microscopic damage to fiber mating surfaces.

To Clean Optical Connectors



Warning:

- **Avoid personal injury! Use of controls, adjustments, or procedures other than those specified herein may result in hazardous radiation exposure.**
- **Avoid personal injury! The laser light source on this equipment (if a transmitter) or the fiber cables connected to this equipment emit invisible laser radiation.**
- **Avoid personal injury! Viewing the laser output (if a transmitter) or fiber cable with optical instruments (such as eye loupes, magnifiers, or microscopes) may pose an eye hazard.**

- Do not apply power to this equipment if the fiber is unmated or unterminated.
- Do not stare into an unmated fiber or at any mirror-like surface that could reflect light emitted from an unterminated fiber.
- Use safety-approved optical fiber cable to maintain compliance with applicable laser safety requirements.

Important: Ensure that no optical power is present prior to this procedure.

- 1 Turn optical power off to the connector.
- 2 Using an optical connector scope, inspect the connector for scratches, burns, or other signs of damage.

Note: If the connector is damaged, replace the jumper.

- 3 If the connector requires cleaning, swipe it across the face of the appropriate ferrule cleaner several times. This will remove dust and some films.

Note: You may hear a slight "squeak" while cleaning the connector, indicating that it is clean.

- 4 Inspect the connector again. If the connector requires further cleaning, clean it using 99% isopropyl alcohol and a lint-free wipe.
- 5 Swipe the connector across the face of the appropriate ferrule cleaner several more times to remove any film left by the alcohol.
- 6 Repeat all the steps above as needed until the connector is clean.

Connecting Optical Cables

Important: This procedure assumes that the Prisma II Chassis is mounted in a rack.

Note: Observe Laser safety precautions when performing this procedure. Refer to *Laser Safety* (on page xix).

To Connect Optical Cables

Complete the following steps to make the optical cable connections for each module to be installed.

- 1 Attach one end of the optical cable to the optical output connector (connector 1), located on the front of the 1550 nm Transmitter.

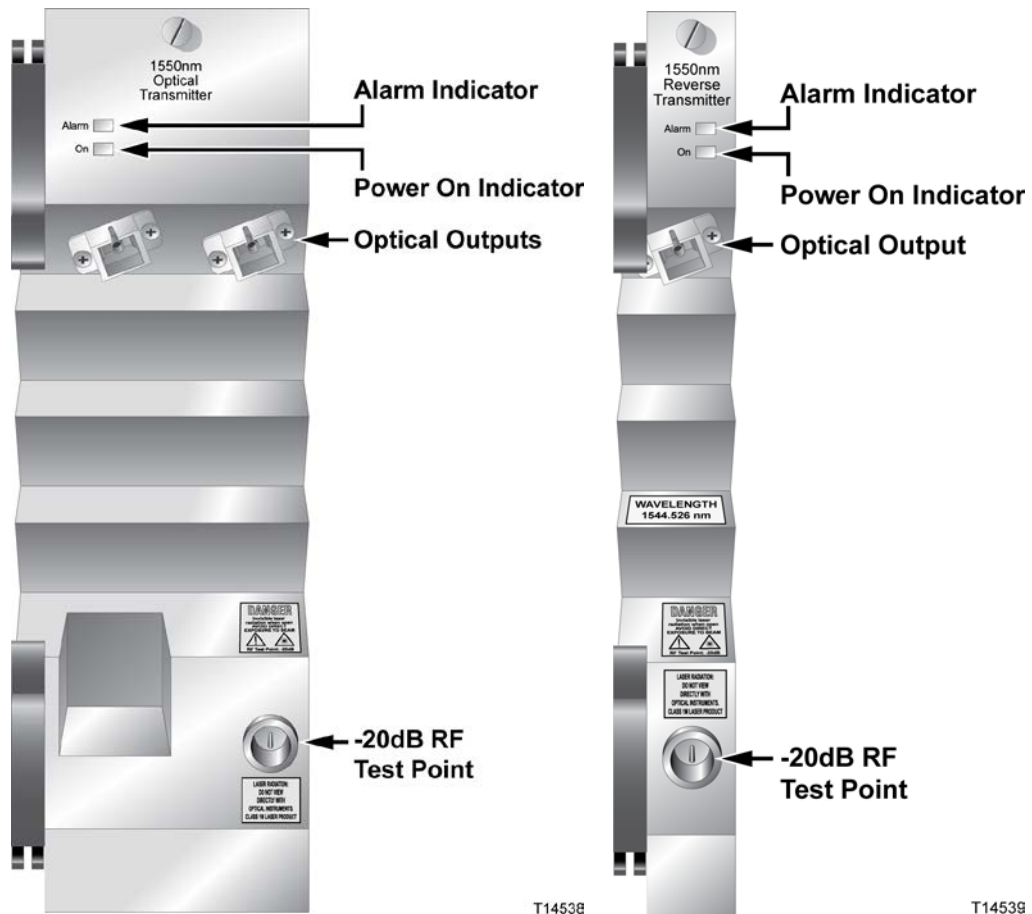

- 2 Route the other end of the optical cable to the appropriate destination.

Connecting the ICIM to Additional Chassis

The Prisma II platform allows the ICIM to be located in one chassis and control modules located in several other chassis. This communication daisy-chain can be enabled by connecting cables to the **ICIM IN** and **ICIM OUT** connectors located on the connector interface panel of the chassis. This connection is required if an ICIM in one chassis is to communicate with or control any module located in a separate chassis.

Note: An ICIM can control a maximum of 140 modules. Depending on your application, this is typically 6 or 7 chassis to a rack. Do not exceed these limits.

ICIM IN and ICIM OUT Connectors

Every Prisma II Chassis has a DB9 **ICIM IN** and a DB9 **ICIM OUT** connector for the purpose of chassis-to-chassis ICIM connections.

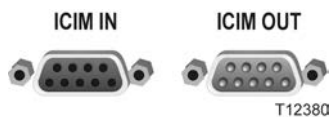

ICIM IN is a female connector and ICIM OUT is a male connector.

ICIM IN and ICIM OUT Cables

The cable required for both **ICIM IN** and **ICIM OUT** connections is a shielded 9-wire serial extension cable, DB9 Female to DB9 Male. This cable can be purchased locally or from the factory. The chassis data sheet lists the part number for a 6-foot DB9 Female to DB9 Male serial extension cable. The connectors are a serial 9-pin D-shell (EIA 574/232).

To Connect Chassis-to-Chassis ICIM IN and ICIM OUT Ports

- 1 Connect the serial extension cable from the **ICIM OUT** of the chassis containing the ICIM to the **ICIM IN** connector of the second chassis.
- 2 Connect a serial extension cable from the **ICIM OUT** of the second chassis to the **ICIM IN** of the third chassis.
- 3 Continue this daisy-chain connection until all chassis are connected.
- 4 Connect an **ICIM OUT** terminator, part number 4013014, to the **ICIM OUT** connector on the last chassis in the daisy-chain connection. The **ICIM OUT** terminator ships with the ICIM.

Important:

- All chassis connected in the daisy-chain must be powered and have a fan tray installed. A chassis connected in the daisy-chain that is not powered or has no fan tray installed will cause faulty operation of the ICIM.
- All chassis connected in this daisy-chain must have a unique chassis ID number.
- If the **ICIM OUT** terminator that ships with the ICIM is not installed on the last chassis of a daisy-chain connection, faulty communication with the ICIM may occur.

Connecting the Chassis to the TNCS Server

Connecting the chassis to the TNCS server requires two special cable kits that are available from the factory.

- The RS-485 cable kit, part number 735748, includes the following:
 - Breakout boxes, 4 each
 - RS-485 cable assemblies (50 feet), 4 each
 - Breakout box mounting brackets, 4 each
 - 6-32 screws (1.25 inches), 100 each
- The Prisma II cable kit, part number 738686, includes the following:
 - Prisma II cable assemblies, 4 each

The RS-485 cable kit is used to communicate with the RS-485/422/TTL devices.

To Connect TNCS to the Chassis EM IN Port

Complete the following steps to connect TNCS to a Prisma II Chassis.

- 1 Mount one of the breakout boxes included in the RS-485 cable kit in a rack location central to the Prisma II Chassis to be connected.



- 2 Connect one of the RS-485 cable assemblies included in the RS-485 cable kit from the breakout box to the **RS-485 COM** port on the TNCS server.
- 3 Connect one of the Prisma II cable assemblies included in the Prisma II cable kit from the breakout box to the **EM IN** port of each Prisma II Chassis containing an ICIM.



Note: We generally recommend that you connect no more than four ICIMs to any single COM port on the TNCS server. If necessary, you may connect more than four ICIMs per TNCS COM port as long as the total number of devices (modules) monitored by a single COM port does not exceed 400 *and* the total number of devices monitored by any single ICIM does not exceed 140.

Using TNCS with Multiple Chassis

All chassis within an ICIM domain are connected in series via the **ICIM IN/ICIM OUT** connectors using standard 9-wire serial extension cable, DB9 Female to DB9 Male. Using the **EM IN/EM OUT** connectors, a chassis with an ICIM installed is connected to a breakout box as shown below.

The breakout box is connected to the TNCS server with the cable included in the RS-485 cable kit.

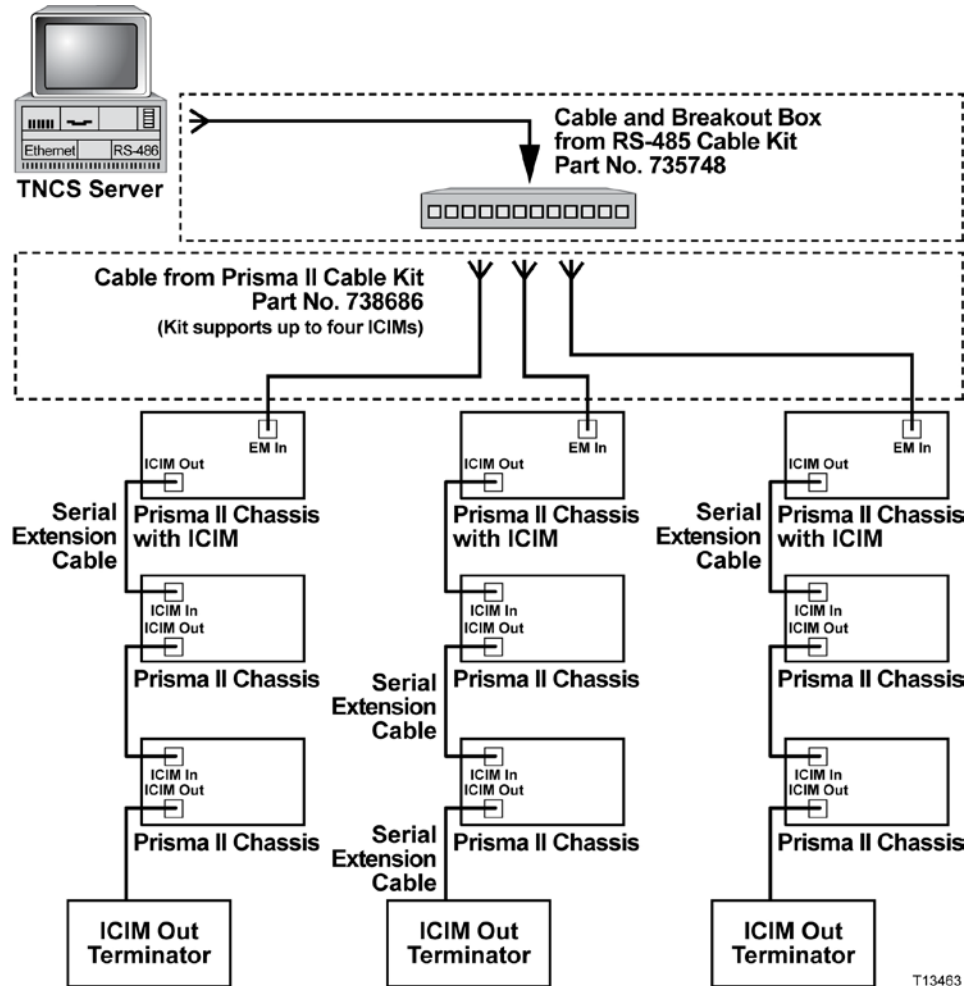

T13463

Making External Alarm Connections

The Prisma II Chassis allows for local hard-wired redundancy by means of the external alarm connections ALARM IN and ALARM OUT, located on the connector interface panel. Using these connections, you can configure a pair of like application modules as a master and slave so that, if the master fails, the slave takes over.

This module ships from the factory configured as a master. You can reconfigure the module as a slave using the LCI or TNCS software or the ICIM to support local hard-wired redundancy.

ALARMS IN and ALARMS OUT Connections

The chassis provides two connections for external alarms to and from each module slot. These alarm connections are located in two 37-pin D-connectors (DB-37) labeled ALARMS IN and ALARMS OUT.

When a critical alarm occurs in a master module, the master turns off and the slave (redundant module) is enabled. To make this happen, the pin representing the master module slot in the ALARM OUT connector must be externally wired to the pin representing the slave module slot in the ALARM IN connector.

Important:

- This module takes up to three slots in the Prisma II chassis. For purposes of redundancy wiring, the module is identified with the higher-numbered slot. For example, if the module occupies slots 6-8 (module ejector lever at slot 6), its ALARM IN and ALARM OUT connections are made at slot 8, and the pins for slots 6 and 7 are not used.
- Any device configured as a master ignores its own ALARM IN contacts.
- To verify proper wiring and redundant configuration, unplug the master device and confirm that the slave module turns on as a result.
- Once the ALARM IN and ALARM OUT contacts are wired, take care to ensure that the master and slave modules are not moved to other slots. If they are, the ALARM IN and ALARM OUT connectors will need to be rewired to the appropriate pins.

ALARMS IN and ALARMS OUT Connector Illustration

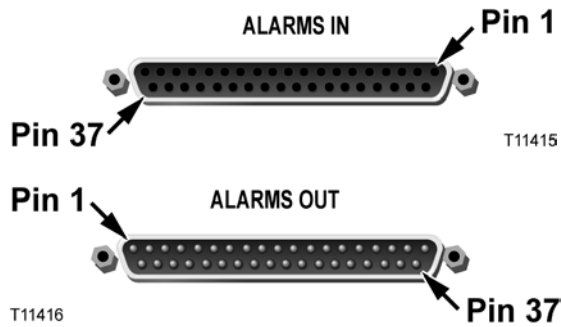

Master/Slave Illustration

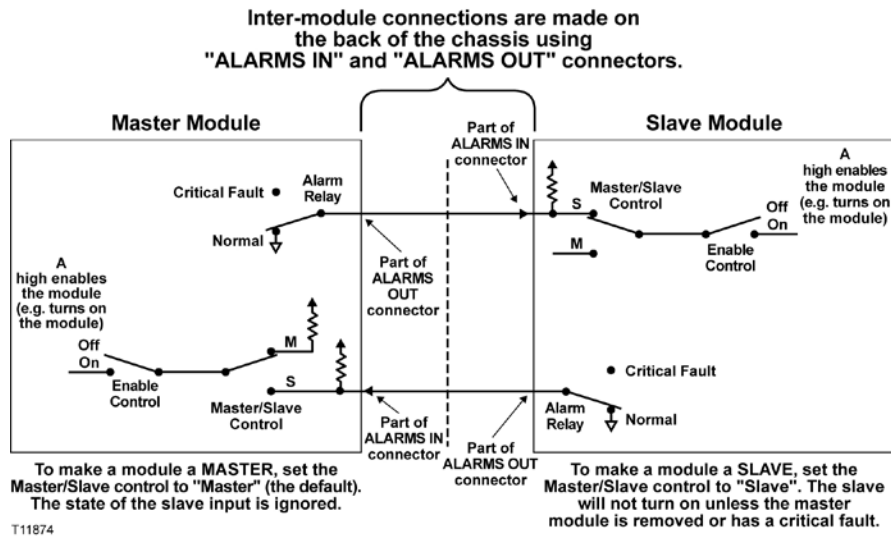

Redundancy Interface Panel

The Prisma II Redundancy Interface Panel is an accessory to the Prisma II platform. It is intended to be used with the master/slave feature and the contact closure alarm feature of the Prisma II platform.

The Prisma II Redundancy Interface Panel serves as an extension to the two DB-37 connectors labeled **ALARM IN** and **ALARM OUT** on the connector interface panel of the chassis. The terminals on the redundancy interface panel are extensions of pins on the **ALARMS OUT** and **ALARMS IN** connectors on the chassis.

For additional information, see the *Prisma II Chassis Installation and Operation Guide*, part number 713375.

Prisma II Redundancy Interface Panel Illustrations

Front Panel

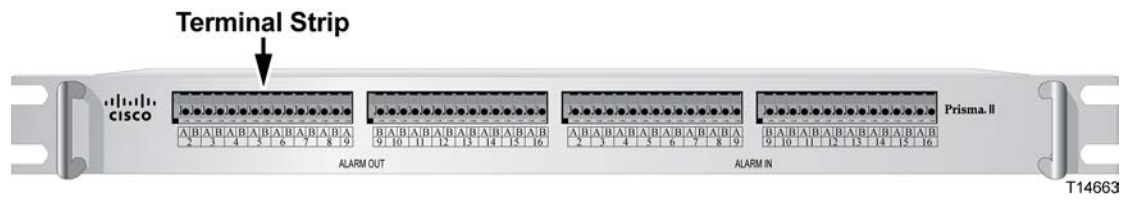

Back Panel

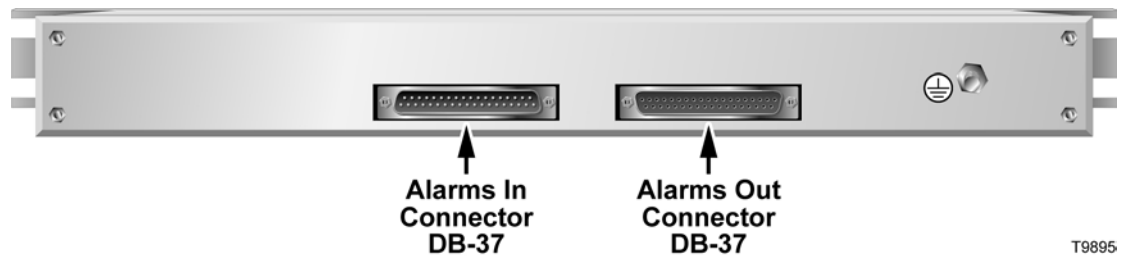

Close-up of Front Panel Terminal Strips



T11921

3

Operation Using the ICIM

The procedures in this chapter apply only if you are using the Prisma II ICIM to configure and operate this module.

This chapter includes descriptions of the ICIM front panel and liquid crystal display (LCD), and detailed procedures for using the ICIM software menus to configure the module.

In This Chapter

■ ICIM Introduction.....	32
■ The ICIM Front Panel.....	33
■ ICIM Password.....	36
■ Using the ICIM.....	41
■ Checking the Operating Status using the ICIM.....	46
■ Configuring the Module using the ICIM.....	48
■ Checking Alarms using the ICIM.....	50
■ Checking Manufacturing Data using the ICIM.....	53
■ Saving the Configuration using the ICIM.....	55
■ SNMP Configuration.....	56
■ Community Strings	59
■ Setting SNMP Trap Receiver Parameters.....	60
■ New SNMP Variables.....	61
■ Boot Dialog for ICIM/SNMP Configuration.....	63
■ Adjusting Alarm Thresholds.....	66

ICIM Introduction

The ICIM serves as the module-to-user interface and as the interface between the Prisma II modules and TNCS or ROSA. The ICIM allows local module configuration and status monitoring for up to 140 modules located in multiple chassis.

Important:

- Do not operate any Prisma II Chassis without a fan tray installed properly. If a fan tray is not installed in the Prisma II Chassis, the ICIM will not communicate with any of the modules in that chassis.
- All chassis connected in a daisy-chain must be powered and have a fan tray installed. A chassis that is connected but is either not powered, or does not have a fan tray installed will cause faulty operation of the ICIM.
- All chassis connected in this daisy-chain must have a unique chassis identification (ID) number.
- The last chassis in the daisy-chain must have a terminator installed in the ICIM OUT connector. Otherwise, faulty communication with the ICIM may occur.

ICIM Block Diagram

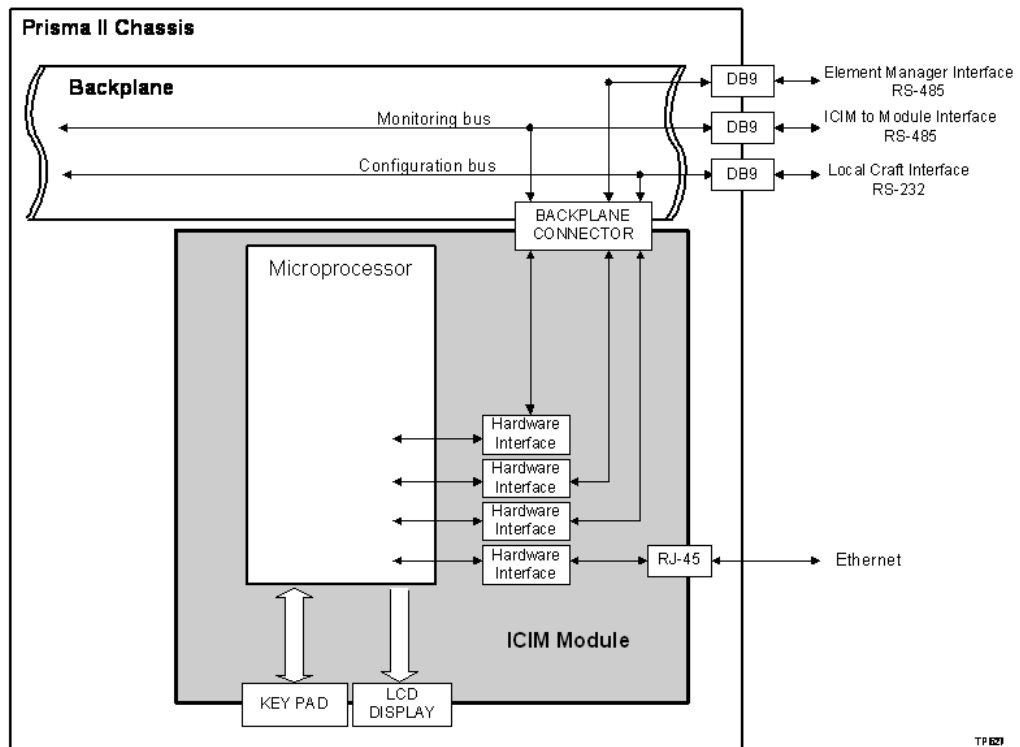

The ICIM Front Panel

ICIM Front Panel Illustration

The ICIM front panel illustration is shown below.

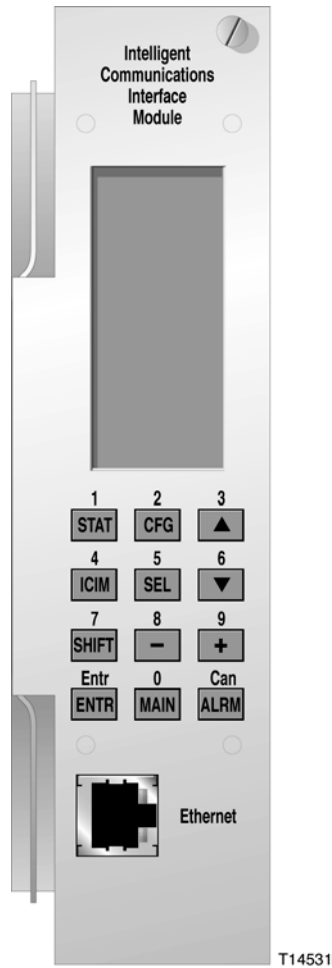

ICIM Front Panel Features

Part	Function
LCD screen	Displays the ICIM menus, alarms, and status information.
12-key numeric keypad	Used to navigate the ICIM menus and configure the application modules.
Ethernet connector	Directly connects the ICIM to a network (future release).

ICIM2 LCD

The LCD on the front panel of the ICIM gives you a visual link to the ICIM firmware. When the ICIM is installed and powered up, the MAIN menu appears on the LCD.













The following illustration shows the ICIM MAIN menu.

MAIN
Offline
Modules 15
Alarms 0
Scroll
Module Shelf Slot

TP011

ICIM Keypad

The ICIM keypad has 12 keys for monitoring parameters. The table below lists each key and briefly describes its function.

Button	Function
	Displays status information for the selected module.
	Displays configuration information for the selected module.
	Displays all of the parameters in alarm for a selected module.
	Moves the menu selection area up.
	Moves the menu selection area down.
	Selects the highlighted parameter.
	Displays ICIM module information such as firmware version and serial number.
	Shifts function of a keypad button to the function or number label just above that button.
	Decreases numerical readings of selected configuration parameters.
	Increases numerical readings of selected configuration parameters.
	Enters input data (if valid).
	Exits the current menu and displays the MAIN menu.

ICIM Password

The ICIM lets you send configuration commands, change alarm thresholds, and restore factory default settings in Prisma II modules. To prevent unauthorized changes to these parameters, you can use a password protection system.

Password authorization only applies to configurable parameters. Status and alarm information is always available on the ICIM, regardless of password implementation.

Password Protection System

The ICIM menu options available in the password protection system are shown here.

Menu Option	Description
User Psw	A user-settable password. <ul style="list-style-type: none"> ■ Created, entered, and changed by the system operator(s) ■ Must be exactly eight digits, using only the 0-9 number keys
Change Psw	Changes an existing user password
Disable Psw	Disables the user password function
SA Psw	A service password that is used by factory personnel only

Important: If you only want to monitor status and alarm data, simply skip the password function when it appears on the ICIM menu. You can access all module status and alarm information without a password.

However, once a user password is entered, you are required to enter it every time you want to set configurable parameters to any module controlled by that ICIM. Refer to *Expired Password or Inactive Password Messages* (on page 37) and *To Enter the User Password* (on page 37).

To Access the Password Menu

The Password menu allows you to create, enter, change, or disable the user password. It also allows service personnel to use the factory default password.

- 1 Press the **ICIM** key.
- 2 Use the **▼** key to scroll down until **Password** is highlighted.
- 3 Press the **SEL** key. The Password menu appears. **User Psw** is highlighted.

MAIN	ICIM	ICIM	ICIM
Offline	Shelf 7 Slot 15	Shelf 7 Slot 15	Shelf 7 Slot 15
Modules 0	Mfg Data	Mfg Data	User Psw
Alarms 0	Password	Password	SA Psw
Scroll	IP Setup	IP Setup	Change Psw
Module Shelf Slot	Update Adr	Update Adr	Disable Psw

TP615

Expired Password or Inactive Password Messages

After entering a valid password, you are authorized to make changes to system parameters. As a security precaution, this authorization expires automatically 10 minutes after your last keystroke.

After your authorization to change system parameters expires:

- If you try to change any system parameters, the menu displays **Psw Expired**.
- If you try to disable the password, the menu displays **Failed, Password Not Active**.

If either of these messages appears, you must re-enter the password as described in *To Enter the User Password* (on page 37) to renew your authorization to change system parameters.

To Enter the User Password

To use the user password feature, you must create and enter a password of exactly eight digits using only the 0-9 number keys.

The password remains active for 10 minutes after your last keystroke. To change configuration parameters after 10 minutes, you must re-enter your password.

Complete the following steps to enter a user password.

- 1 Access the Password menu as shown in *To Access the Password Menu* (on page 36).
- 2 Press the **SEL** key. The user password menu appears.
- 3 When **User Psw/Shift Off** appears, press the **SHIFT** key to display **Shift On**, and then enter the eight digits of your password, using the 0-9 number keys.
 - To change a digit you have just typed, use the **CAN** (Cancel) function by pressing the **ALRM** key. This deletes the last digit typed.
- 4 Press the **ENTER** key to enter the password. The ICIM display updates to show whether your password entry was accepted.
 - If the password is accepted, the word **Accepted** appears in the menu, and you are able to return to the MAIN menu.
 - If the password was rejected, the word **Rejected** appears in the menu. Reasons for a password to be rejected include:
 - Entering more than eight digits for the password.
 - Pressing keys other than the 0-9 number keys.
 - Entering an incorrect password if a valid password has been entered.

If the password is rejected, press the **SHIFT** key to return to the password menu and re-enter the password as described in step 3 above.







ICIM	ICIM	ICIM	ICIM
Shelf 0 Slot 15	Shelf 0 Slot 15	Shelf 0 Slot 15	Shelf 0 Slot 15
User Psw	User Psw *****	User Psw 1234****	User Psw 12345678
Shift Off	Shift On	Rejected Shift Off	Accepted Shift Off

TPD 3

To Change the User Password

After entering a user password, you are authorized to change it as long as the current password is active. If more than 10 minutes elapse since your last keystroke, this authorization expires and you must re-enter the current password before changing to a new one.

Complete the following steps to change the user password.

- 1 Access the Password menu as shown in *To Access the Password Menu* (on page 36).
- 2 Use the  key to scroll down until **Change Psw** is highlighted.
- 3 Press the  key to select **Change Psw**.
- 4 When **Change Psw/Shift Off** appears, press the  key to display **Shift On**, and then enter the eight digits of your new password, using the 0-9 number keys.
 - To change a digit you have just typed, use the **CAN** (Cancel) function by pressing the  key. This deletes the last digit typed.
- 5 Press the  key to input the new password. The ICIM display updates to show whether your password entry was accepted.
 - If the new password entry was accepted, you are able to return to the MAIN menu.
 - If the new password entry was rejected:
 - Press the  key to return to the password entry menu.
 - Clear all digits using the **CAN** (Cancel) function.
 - Re-enter an 8-digit password using only the 0-9 number keys.
 - Press the  key to input the password.





ICIM	ICIM	ICIM	ICIM
Shelf 7 Slot 15	Shelf 7 Slot 15	Shelf 7 Slot 15	Shelf 7 Slot 15
User Psw	Change Psw	Change Psw *****	Change Psw 87654321
SA Psw			
Change Psw			
Disable Psw	Shift Off	Shift On	Shift On

TPM 4

To Disable the User Password using ICIM

You can disable a user password at any time, provided that the password is active before disabling it. If the current password expires because more than 10 minutes pass since your last keystroke, you must re-enter the password before disabling it.

Note: After disabling the user password, you can re-enable password protection by entering a new user password.

- 1 Press the  key.
- 2 Use the  key to scroll down until **Password** is highlighted.
- 3 Press the  key.
- 4 Use the  key to scroll down until **Disable Psw** is highlighted.
- 5 Press the  key to select **Disable Psw**.
- 6 If the current password is active, the menu displays **Password Is Now Disabled**. You can now make changes to parameters without any password.
- 7 If the current password expires because more than 10 minutes pass since your last keystroke, the menu displays **Failed, Password Not Active**. You must re-enter the password and then repeat this procedure.



ICIM	ICIM	ICIM
Shelf 7 Slot 15	Shelf 7 Slot 15	Shelf 7 Slot 15
User Psw	Enter Psw 8765****	Enter Psw 87654321
SA Psw		
Change Psw	Password Is Now Disabled	Failed, Password Not Active
Disable Psw	Shift Off	Shift Off

TPDS

Using the ICIM

Once the module is installed, it runs without the aid of an operator. Unless alarms are generated or your system configuration changes, you should not need to make any adjustments to the module beyond the initial setup.

To Adjust the LCD Contrast

To access the ICIM LCD contrast control from the MAIN menu, press the  key. Use the  key to increase or the  key to decrease ICIM display contrast.

Note: Do not hold down the ICIM key while adjusting the LCD contrast.

To Access the MAIN Menu

A few seconds after power-up, the MAIN menu appears. Press the  key to select the specific option.

Display	Description
Offline	Indicates TNCS or ROSA communication status with the ICIM.
Modules	Indicates the number of modules in the ICIM domain.
Alarms	Displays the number of currently active alarms. Selecting this option allows scrolling through all modules in alarm condition.
Scroll	Allows scrolling through all modules in the ICIM domain.
Module Shelf Slot	Allows selection of any specific module in the ICIM domain.

The ICIM MAIN menu is shown below.

MAIN
Offline
Modules 15
Alarms 0
Scroll
Module Shelf Slot

TP011

To Access the ICIM Menu

To display the ICIM menu, press the **ICIM** key. The ICIM menu appears as shown below. Press the **SEL** key to select the specific option.

Display	Description
Shelf Slot	Displays the location of the ICIM module. Shelf = Chassis ID number on the front of the chassis. Slot = Slot number within the chassis.
Mfg Data	Displays manufacturing data about the ICIM.
IP Setup	Press the SEL key to view the IP Address, IP Subnet, and Gateway IP of the ICIM. These values are read-only via the ICIM2 front panel. These parameters can be changed via CLI or the Boot Dialog interface.

The ICIM menu appears as shown below.

ICIM	ICIM
Shelf 0	Shelf 0
Slot 15	Slot 15
Mfg Data	Mfg Data
IP Setup	IP Setup

TP099

MAIN and ICIM Menu Structures

Pressing the **MAIN** key initiates the MAIN software menu. Pressing the **ICIM** key initiates the ICIM software menu.

The MAIN and ICIM software menu structures are shown below.

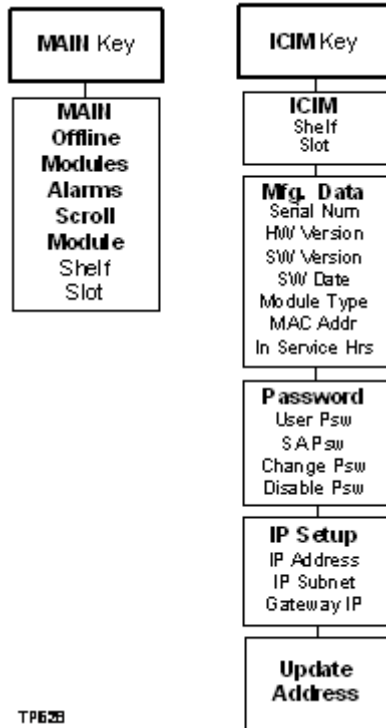

Prisma II 1550 nm Long Reach and Extended Reach EMT (TXL,TXX) Software Menu Structure

From the MAIN menu, you can navigate to the MODULE menu. From the MODULE menu, press the **STAT**, **CFG**, or **ALRM** key to display the desired parameter menu.

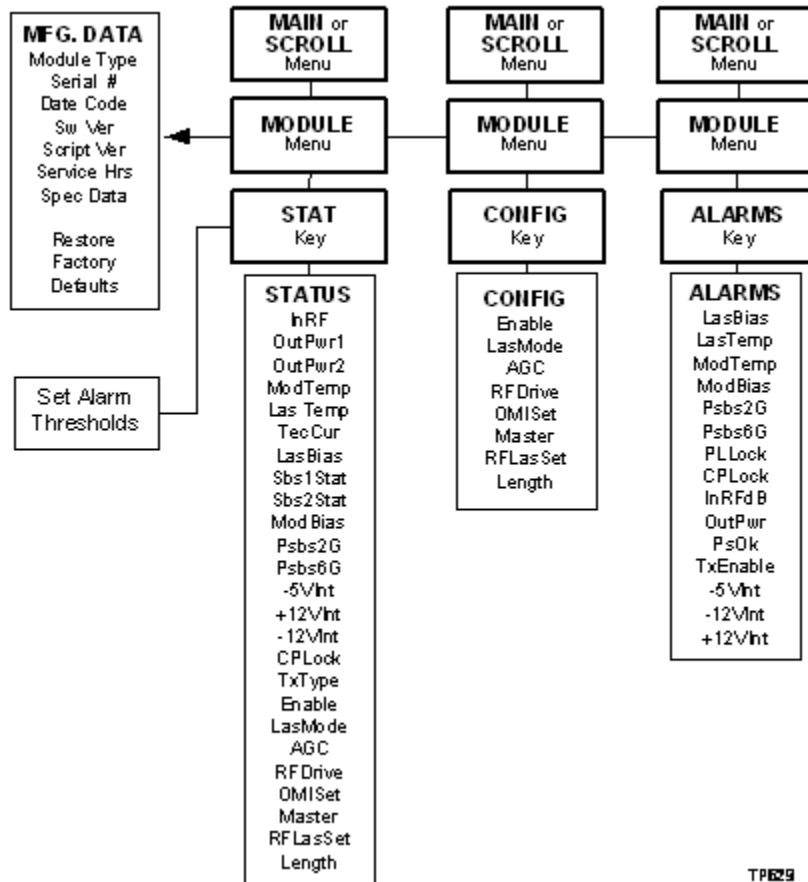

TP629

Prisma II 1550 nm Full Height Reverse QAM (TXR) Transmitter Software Menu Structure



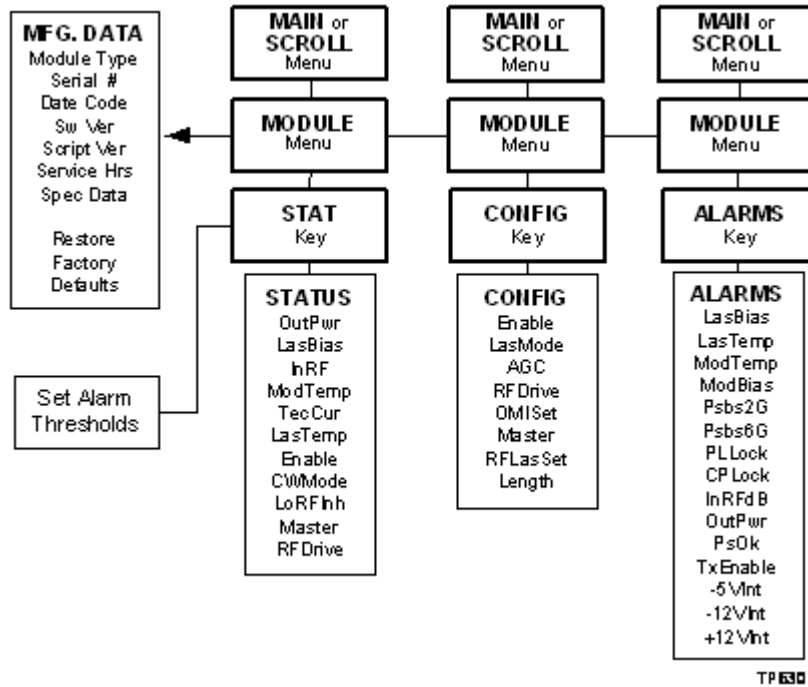









From the MAIN menu, you can navigate to the MODULE menu. From the MODULE menu, press the **STAT**, **CFG**, or **ALRM** key to display the desired parameter menu.



Checking the Operating Status using the ICIM

To Check Operating Status using the ICIM

You can use the ICIM to check the status of all operating parameters of this module. All status information is displayed on the ICIM front panel LCD.

- 1 At the MAIN menu, press the  key to highlight the **Shelf** and **Slot** fields.
- 2 Press the  key to address the **Shelf** number. Then press the  key or the  key to scroll to the number of the desired shelf.
- 3 Press the  key.
Result: The **Slot** field is highlighted.
- 4 Press the  key or the  key to scroll to the number of the desired slot.
- 5 Press the  key.
Result: The **MODULE** menu appears on the ICIM LCD.
- 6 Press the  key.
- 7 Press the  key or the  key to scroll through the monitored parameters until you find the parameter of interest.
- 8 Check the status of the desired parameter or select other parameters to monitor.
When finished, press the  key to return to the **MAIN** menu.

STATUS Menus

Press the **STAT** key to select the STATUS menu. Typical STATUS menus are shown below.

<table border="1"> <thead> <tr><th colspan="2">STATUS</th></tr> </thead> <tbody> <tr><td>Shelf</td><td>0</td></tr> <tr><td>Slot</td><td>6</td></tr> <tr><td colspan="2">-----</td></tr> <tr><td colspan="2">1550 nm Optical Transmit</td></tr> <tr><td colspan="2">-----</td></tr> <tr><td>InRF</td><td>-11.5 dB</td></tr> <tr><td>OutPwr1</td><td>8.5 dBm</td></tr> <tr><td colspan="2">▲ ▼</td></tr> </tbody> </table>	STATUS		Shelf	0	Slot	6	-----		1550 nm Optical Transmit		-----		InRF	-11.5 dB	OutPwr1	8.5 dBm	▲ ▼		<table border="1"> <thead> <tr><th colspan="2">STATUS</th></tr> </thead> <tbody> <tr><td>Shelf</td><td>0</td></tr> <tr><td>Slot</td><td>6</td></tr> <tr><td colspan="2">-----</td></tr> <tr><td colspan="2">1550 nm Optical Transmit</td></tr> <tr><td colspan="2">-----</td></tr> <tr><td>CPLock</td><td>0.004#</td></tr> <tr><td>ModTemp</td><td>34.39 deg C</td></tr> <tr><td colspan="2">▲ ▼</td></tr> </tbody> </table>	STATUS		Shelf	0	Slot	6	-----		1550 nm Optical Transmit		-----		CPLock	0.004#	ModTemp	34.39 deg C	▲ ▼		<table border="1"> <thead> <tr><th colspan="2">STATUS</th></tr> </thead> <tbody> <tr><td>Shelf</td><td>0</td></tr> <tr><td>Slot</td><td>6</td></tr> <tr><td colspan="2">-----</td></tr> <tr><td colspan="2">1550 nm Optical Transmit</td></tr> <tr><td colspan="2">-----</td></tr> <tr><td>LasTemp</td><td>29.5 deg C</td></tr> <tr><td>TecCur</td><td>.151 A</td></tr> <tr><td colspan="2">▲ ▼</td></tr> </tbody> </table>	STATUS		Shelf	0	Slot	6	-----		1550 nm Optical Transmit		-----		LasTemp	29.5 deg C	TecCur	.151 A	▲ ▼		<table border="1"> <thead> <tr><th colspan="2">STATUS</th></tr> </thead> <tbody> <tr><td>Shelf</td><td>0</td></tr> <tr><td>Slot</td><td>6</td></tr> <tr><td colspan="2">-----</td></tr> <tr><td colspan="2">1550 nm Optical Transmit</td></tr> <tr><td colspan="2">-----</td></tr> <tr><td>LasBias</td><td>257 mA</td></tr> <tr><td>ModBias</td><td>0.028 V</td></tr> <tr><td colspan="2">▲ ▼</td></tr> </tbody> </table>	STATUS		Shelf	0	Slot	6	-----		1550 nm Optical Transmit		-----		LasBias	257 mA	ModBias	0.028 V	▲ ▼	
STATUS																																																																											
Shelf	0																																																																										
Slot	6																																																																										

1550 nm Optical Transmit																																																																											

InRF	-11.5 dB																																																																										
OutPwr1	8.5 dBm																																																																										
▲ ▼																																																																											
STATUS																																																																											
Shelf	0																																																																										
Slot	6																																																																										

1550 nm Optical Transmit																																																																											

CPLock	0.004#																																																																										
ModTemp	34.39 deg C																																																																										
▲ ▼																																																																											
STATUS																																																																											
Shelf	0																																																																										
Slot	6																																																																										

1550 nm Optical Transmit																																																																											

LasTemp	29.5 deg C																																																																										
TecCur	.151 A																																																																										
▲ ▼																																																																											
STATUS																																																																											
Shelf	0																																																																										
Slot	6																																																																										

1550 nm Optical Transmit																																																																											

LasBias	257 mA																																																																										
ModBias	0.028 V																																																																										
▲ ▼																																																																											
<table border="1"> <thead> <tr><th colspan="2">STATUS</th></tr> </thead> <tbody> <tr><td>Shelf</td><td>0</td></tr> <tr><td>Slot</td><td>6</td></tr> <tr><td colspan="2">-----</td></tr> <tr><td colspan="2">1550 nm Optical Transmit</td></tr> <tr><td colspan="2">-----</td></tr> <tr><td>Sbs1Stat</td><td>LOCK</td></tr> <tr><td>Psbs2G</td><td>146.1</td></tr> <tr><td colspan="2">▲ ▼</td></tr> </tbody> </table>	STATUS		Shelf	0	Slot	6	-----		1550 nm Optical Transmit		-----		Sbs1Stat	LOCK	Psbs2G	146.1	▲ ▼		<table border="1"> <thead> <tr><th colspan="2">STATUS</th></tr> </thead> <tbody> <tr><td>Shelf</td><td>0</td></tr> <tr><td>Slot</td><td>6</td></tr> <tr><td colspan="2">-----</td></tr> <tr><td colspan="2">1550 nm Optical Transmit</td></tr> <tr><td colspan="2">-----</td></tr> <tr><td>-5VInt</td><td>-5.1 V</td></tr> <tr><td>+12VInt</td><td>+12.3 V</td></tr> <tr><td colspan="2">▲ ▼</td></tr> </tbody> </table>	STATUS		Shelf	0	Slot	6	-----		1550 nm Optical Transmit		-----		-5VInt	-5.1 V	+12VInt	+12.3 V	▲ ▼		<table border="1"> <thead> <tr><th colspan="2">STATUS</th></tr> </thead> <tbody> <tr><td>Shelf</td><td>0</td></tr> <tr><td>Slot</td><td>6</td></tr> <tr><td colspan="2">-----</td></tr> <tr><td colspan="2">1550 nm Optical Transmit</td></tr> <tr><td colspan="2">-----</td></tr> <tr><td>LasMode</td><td>CostCur</td></tr> <tr><td>ACG</td><td>OFF</td></tr> <tr><td colspan="2">▲ ▼</td></tr> </tbody> </table>	STATUS		Shelf	0	Slot	6	-----		1550 nm Optical Transmit		-----		LasMode	CostCur	ACG	OFF	▲ ▼		<table border="1"> <thead> <tr><th colspan="2">STATUS</th></tr> </thead> <tbody> <tr><td>Shelf</td><td>0</td></tr> <tr><td>Slot</td><td>6</td></tr> <tr><td colspan="2">-----</td></tr> <tr><td colspan="2">1550 nm Optical Transmit</td></tr> <tr><td colspan="2">-----</td></tr> <tr><td>RFDrive</td><td>0 dB</td></tr> <tr><td>OMISet</td><td>0 dB</td></tr> <tr><td colspan="2">▲ ▼</td></tr> </tbody> </table>	STATUS		Shelf	0	Slot	6	-----		1550 nm Optical Transmit		-----		RFDrive	0 dB	OMISet	0 dB	▲ ▼	
STATUS																																																																											
Shelf	0																																																																										
Slot	6																																																																										

1550 nm Optical Transmit																																																																											

Sbs1Stat	LOCK																																																																										
Psbs2G	146.1																																																																										
▲ ▼																																																																											
STATUS																																																																											
Shelf	0																																																																										
Slot	6																																																																										

1550 nm Optical Transmit																																																																											

-5VInt	-5.1 V																																																																										
+12VInt	+12.3 V																																																																										
▲ ▼																																																																											
STATUS																																																																											
Shelf	0																																																																										
Slot	6																																																																										

1550 nm Optical Transmit																																																																											

LasMode	CostCur																																																																										
ACG	OFF																																																																										
▲ ▼																																																																											
STATUS																																																																											
Shelf	0																																																																										
Slot	6																																																																										

1550 nm Optical Transmit																																																																											

RFDrive	0 dB																																																																										
OMISet	0 dB																																																																										
▲ ▼																																																																											















TP631

Note: For details on all operating status parameters, see *Module Parameter Descriptions* (on page 105).



Configuring the Module using the ICIM

To Configure Parameters using the ICIM

You can use the ICIM to configure the parameters of this module.

- 1 From the **MAIN** menu, press the  key to highlight the **Shelf** and **Slot** fields.
- 2 Press the  key to address the **Shelf** number. Then press the  key or the  key to scroll to the number of the desired shelf.
- 3 Press the  key. The **Slot** field is highlighted.
- 4 Press the  key or the  keys to scroll to the number of the desired slot.
- 5 Press the  key. The **MODULE** menu appears on the ICIM LCD.
- 6 To configure the module, press the  key.
- 7 Press the  key or the  key to scroll through the configurable controls until you find the parameter of interest.
- 8 Press the  key to select the highlighted control.
- 9 Press the  key or the  key to activate or change the value of the selected control.
- 10 Press the  key to save the changes and return to the **MAIN** menu.

CONFIG Menus

When the **CONFIG** menu is selected, the **Shelf** number field is highlighted. The shelf and slot number fields may only be incremented with the  key or the  key. The  key highlights the **Slot** number field. Once you exit the slot field, the Up and Down arrows will scroll through the parameters that are specific to this module.

Sample **CONFIG** menus are shown below.

<pre> CONFIG ----- Shelf 0 Slot 6 ----- 1550 nm Optical Transmit ----- Enable LasMode AGC RFDrive OMISet ▲ ▼ </pre>	<pre> CONFIG ----- Shelf 0 Slot 6 ----- 1550 nm Optical Transmit ----- Master ▲ ▼ </pre>	<pre> CONFIG ----- Shelf 0 Slot 6 ----- 1550 nm Optical Transmit ----- Enable ON ▲ ▼ </pre>	<pre> CONFIG ----- Shelf 0 Slot 6 ----- 1550 nm Optical Transmit ----- LasMode ConstCur ▲ ▼ </pre>
<pre> CONFIG ----- Shelf 0 Slot 6 ----- 1550 nm Optical Transmit ----- AGC OFF ▲ ▼ </pre>	<pre> CONFIG ----- Shelf 0 Slot 6 ----- 1550 nm Optical Transmit ----- RFDrive 0 dB ▲ ▼ </pre>	<pre> CONFIG ----- Shelf 0 Slot 6 ----- 1550 nm Optical Transmit ----- OMISet 0 dB ▲ ▼ </pre>	<pre> CONFIG ----- Shelf 0 Slot 6 ----- 1550 nm Optical Transmit ----- Master Master ▲ ▼ </pre>

TP132

Note: For details on all configurable parameters, see *Module Parameter Descriptions* (on page 105).













Checking Alarms using the ICIM

To Check Alarms using the ICIM

Alarms fall into one of the following categories.

- Major low
- Minor low
- Minor high
- Major high

If the red ALARM LED on the front panel is blinking, a minor alarm condition is indicated. If the ALARM LED on the front panel is illuminated, a major alarm condition is indicated.

- 1 From the MAIN menu, press the  key to highlight the **Shelf** and **Slot** fields.
- 2 Press the  key to address the **Shelf** number. Then press the  key or the  keys to scroll to the number of the desired shelf.
- 3 Press the  key.
Result: The **Slot** field is highlighted.
- 4 Press the  key or the  key to scroll to the number of the desired slot.
- 5 Press the  key.
Result: The **MODULE** menu appears on the ICIM LCD.
- 6 Press the  key.
Result: Module alarm conditions display.
- 7 Use the  key or the  key to scroll through alarm conditions until the desired alarm is displayed.
- 8 Monitor the alarm condition(s). Take appropriate action. Verify that all settings and thresholds relating to the alarm indication are set correctly to rule out an unintended alarm.
- 9 When finished, press the  key to return to the MAIN menu.

To View Alarms

When a module ALARMS menu is selected, press the  key or the  key to scroll through alarms. Typical ALARMS menus are shown below.



ALARMS Shelf 0 Slot 6 ----- 1550 nm Optical Transmit ----- LasBias Minor High ▲ ▼	ALARMS Shelf 0 Slot 6 ----- 1550 nm Optical Transmit ----- LasTemp Minor High ▲ ▼	ALARMS Shelf 0 Slot 6 ----- 1550 nm Optical Transmit ----- ModTemp Minor High ▲ ▼	ALARMS Shelf 0 Slot 6 ----- 1550 nm Optical Transmit ----- ModBias Minor High ▲ ▼
ALARMS Shelf 0 Slot 6 ----- 1550 nm Optical Transmit ----- Psbs2G 200 ▲ ▼	ALARMS Shelf 0 Slot 6 ----- 1550 nm Optical Transmit ----- Lock2G Lock ▲ ▼	ALARMS Shelf 0 Slot 6 ----- 1550 nm Optical Transmit ----- CPLock Lock PLLock Lock ▲ ▼	ALARMS Shelf 0 Slot 6 ----- 1550 nm Optical Transmit ----- InRF Major High

TP 633

Note: For details on all alarm parameters, see *Module Parameter Descriptions* (on page 105).

To Set Adjustable Alarm Thresholds using the ICIM

You can use the ICIM to change the adjustable alarm thresholds of this module from their factory default values.

- 1 At the MODULE menu, press the  key. The STATUS menu appears on the ICIM LCD.
- 2 Press the  key. The alarm thresholds previously set are displayed. If the label **n/a** is displayed, you cannot configure that alarm threshold. Press the  key to highlight the alarm threshold for the next parameter.

- 3 When the threshold that you wish to set is highlighted, press the **ENTER** key.
 - 4 Press the **▼** key or the **▲** key to change the increment size.
 - 5 Press the **+** key or the **-** key to adjust the alarm threshold.
- Note:** Press the Cancel (**ALRM**) key to return to the previous menu.
- 6 Press the **ENTER** key to save the changes. The message **Data Saved** appears on the ICIM LCD.
 - 7 When finished, press the **MAIN** key to return to the MAIN menu.

To Check Alarm Thresholds

Complete the following steps to view alarm threshold factory default values.

- 1 At the MODULE menu, press the **STAT** key. The ICIM LCD displays the STATUS menu.
- 2 Press the **SEL** key. The alarm thresholds previously set are displayed.
- 3 When finished, press the **MAIN** key to return to the MAIN menu.

Alarm Threshold Menus

Some typical alarm threshold menus are shown below.

STATUS Shelf 0 Slot 6	STATUS Shelf 0 Slot 6	STATUS Shelf 0 Slot 6	STATUS Shelf 0 Slot 6
1550 nm Optical Transmit	1550 nm Optical Transmit	1550 nm Optical Transmit	1550 nm Optical Transmit
LasBias MajH100.0 MinH50.00 MinL-50.00 MajL-100.0 ▲ ▼	LasTemp MajH39.99 MinH30.99 MinL28.99 MajL19.99 ▲ ▼	ModTemp MajH85.00 MinH78.00 MinL-21.00 MajL-30.00 ▲ ▼	ModBias MajH9.500 MinH5.000 MinL-5.000 MajL-9.500

TP631









Note: For details on all alarm thresholds, see *Module Parameter Descriptions* (on page 105).

Checking Manufacturing Data using the ICIM

To Check Manufacturing Data



You can display the manufacturing data for this module on the ICIM LCD.

Complete the following steps to access the manufacturing data.



- 1 From the MAIN menu, press the  key to highlight the **Shelf** and **Slot** fields.
- 2 Press the  key to address the **Shelf** number. Then press the  key or the  key to scroll to the number of the desired shelf.
- 3 Press the  key. The **Slot** field is highlighted.
- 4 Press the  key or the  key to scroll to the number of the desired slot.
- 5 Press the  key. The MODULE menu for this module will be selected, as shown on the left below. Press the  key to enter the start of the MFG. DATA menus, as shown on the right below.

MODULE	MFG. DATA
Shelf 0	Shelf 0
Slot 6	Slot 6
1550 nm Optical Transmit	1550 nm Optical Transmit
Alarms 1	Module Type
Mfg. Data	1001
▲ ▼	▲ ▼

TP635

- 6 Use the  and  keys to scroll through the manufacturing data.

MFG. DATA Menus

When the **MFG. DATA** menu is selected, the  key or the  key allows you to scroll through the manufacturing parameters specific to this module. Sample **MFG. DATA** menus are shown below.

MFG.DATA	MFG.DATA	MFG.DATA	MFG.DATA
Shelf 0 Slot 6	Shelf 0 Slot 6	Shelf 0 Slot 6	Shelf 0 Slot 6
1550 nm Optical Transmit	1550 nm Optical Transmit	1550 nm Optical Transmit	1550 nm Optical Transmit
Module Type 1001 ▲ ▼	Serial # AAYCUA Date Code A01 ▲ ▼	Sw Rev CCB606 Script Ver 1300 ▲ ▼	In Service Hours 1 ▲ ▼

TP 636

Note: For details on all manufacturing data parameters, see *Module Parameter Descriptions* (on page 105).

Saving the Configuration using the ICIM

To Save the Current Configuration

- 1 After you have changed a parameter or entered data, press the **ENTER** key to save the changes and return to the MAIN menu.
- 2 If you do not save your changes for two minutes, or if you press the **SHIFT** **CAN** keys at the same time, changes are aborted and the display returns to the MAIN menu.

Configuration Complete

If no alarms are indicated after using the ICIM to configure this module to your system specifications, no further action is necessary. The module operates without further input. Alarms, changes in operating parameters, electrical power fluctuations, or changes in system design may be cause for additional action.

SNMP Configuration

The IP Setup item in the ICIM menu lets you enter an IP address, IP subnet, and Gateway IP to configure the ICIM for remote status monitoring and control by a Simple Network Management Protocol (SNMP) network management system.

This section does not describe SNMP implementation. Refer to your SNMP manager documentation or management information base (MIB) information for instructions on implementing SNMP, Version 1.

All of this configuration is also available through the Boot Dialog. The Boot Dialog also allows community names and the default port number for traps to be changed.

Note: Contact Customer Service for MIB files. Refer to *Customer Information* (on page 103) for assistance center phone numbers.

SNMP Considerations













The following items should be considered when implementing SNMP.

- The SNMP connection is made through the Ethernet port on the front of the ICIM. (Use 10baseT cable with an RJ-45 connector.) To meet the requirements of GR1089-CORE, a shielded cable must be used and both ends must be grounded.
- The network management system (NMS) must be installed behind a firewall to prevent any ill-intentioned persons with an SNMP manager from accessing and tampering with the ICIM.
- When the ICIM has to handle excessive SNMP traffic, it will respond slowly to both SNMP control and front panel input. If this occurs, reduce the update rate of the SNMP manager.

Basic SNMP Setup

Refer to your SNMP manager documentation or MIB information for instructions on implementing SNMP. Before you can use and reconfigure SNMP services, you need to know the community strings in your network and the IP addresses or computer names for SNMP management hosts to which traps are sent.

To Set Up the IP Configuration Parameters for SNMP Support using ICIM

- 1 Press the  key. The ICIM menu appears on the ICIM LCD.
- 2 Select the **Password** menu and enter the User Password. The ICIM allows configuration changes for the next 10 minutes.
Note: Refer to your specific hardware Installation and Operation Guide for more information on using, entering, or changing the ICIM user password.
- 3 Press the  key. The ICIM menu appears.
- 4 Use the  key to scroll down until **IP Setup** is highlighted.
- 5 Press the  key. The **IP Setup** menu appears.
- 6 Use the  or  keys to scroll to and highlight the desired configuration parameter; IP Address, IP Subnet, or Gateway IP.
- 7 Press the  key. The **Adjust** menu for the selected IP parameter appears, and the first segment of the address is highlighted.
- 8 Enter the correct numbers for the first segment of the address.
Note: One of two methods can be used to enter the numbers, as follows:
 - Press the  or  keys to increase/decrease the number to set value.
 - Press the  key to change to the numeric entry mode. Confirm that **Numlock On** appears on the front panel LCD. Then enter the exact number using the number keys on the 12-key numeric keypad.
- 9 Press the  key to accept your entry and move to the next address segment to the right. You can also use the  or  keys to move to the address segment of your choice.
Note: If you are using the numeric entry mode, the cursor moves to the next address segment to the right automatically after you enter the last digit of the current address segment.
- 10 Repeat steps 8 and 9 until all address segments are entered. After you enter the last address segment and press the Enter key, the system returns to the IP Setup menu.
- 11 Repeat steps 6 through 10 for each IP Setup parameter that you need to enter.
- 12 Restart the ICIM.

Important: IP Setup parameters do not take effect until the ICIM is restarted.

To Restart the ICIM by Removing the ICIM

- 1 Unscrew the captive screw near the top right-hand corner of the ICIM.
- 2 Unlock the top and bottom ejector levers near the left-hand side of the ICIM.
- 3 Pull the ejector levers out and away from the front panel to disconnect the ICIM from the chassis backplane connector.
- 4 Pull the ICIM at least 1.5 inches (3.81 cm) out from the front of the chassis to ensure that it is fully separated from the chassis backplane connector.
- 5 Reinsert the ICIM into the chassis until the ejector levers insert into their respective slots in the chassis.
- 6 Push the ejector levers in and flat against the ICIM front panel to reconnect the ICIM to the backplane connector until the ejector levers lock in place.
- 7 Screw in the captive screw to secure the ICIM in the chassis.

Community Strings

Default Community Strings

The community string provides primitive security and context checking for both agents and managers that request and initiate trap operations. An agent does not accept a request from a manager outside the community.

Community strings that the ICIM expects are:

Read Community	public
Write Community	private
Trap Community	SNMP_trap

Setting SNMP Trap Receiver Parameters

You can use the SNMP trap receiver parameters to specify up to five IP addresses to which proprietary traps will be sent. You can also specify the events that will result in a trap being sent to the network management systems at these IP addresses.

The Cold Start trap will always be sent to all network management systems. The Authentication Failure trap will also be sent to all trap receivers if the `snmpEnableAuthenTraps` is set to Enabled.

You can specify which enterprise specific traps are sent to each trap receiver by setting variables in the `P2TrapRecv` table.

To Set Traps for a Specific IP Address using `P2TrapRecvEntry`

Entries to the `P2TrapRecvEntry` file can be made to send the trap information to a trap handler. The SNMP agent automatically sends an alert when the value of an object changes or exceeds a predefined threshold.

- 1 On an SNMP manager, go to the `P2TrapRecvEntry` table.
- 2 Type the IP address to which you want the trap sent.
- 3 Select **Enable** from the drop-down list. The new IP address is enabled and traps are sent to this IP address.

Note: Any changes are immediately stored to the EEPROM, so the changes are not lost if power is lost or the ICIM is reset.

New SNMP Variables

Support for traps requires additional data available through SNMP. This additional data may be useful even if not using traps.

SNMP is the only way this additional data can be accessed. It cannot be accessed through the ICIM front panel or an SMC interface.

Table of Inserted Modules

This table is named p2InsertModuleTable. It contains a list of modules inserted since the last time the ICIM was reset or told to update the chassis ID for all modules. It does not include modules found when the initial search for modules is performed.

The modules are displayed in chronological order, with the most recently inserted module always being in index position 1. If the number of modules inserted exceeds the capacity of the table, the oldest entries are deleted.

This table only contains the chassis and slot ID for a detected module. It is necessary to look at the other tables for more information.

Each row of this table is made up of the following variables:

Variable	Description
p2InsertModuleIndex	The index for this table. The most recently inserted module is always in index position 1.
p2InsertModuleChassisID	The chassis ID number of the new module.
p2InsertModuleSlotID	The slot ID number of the new module.

Table of Removed Modules

This table is named p2RemoveModuleTable. It contains a list of modules removed since the last time the ICIM was reset or told to update the chassis ID for all modules.

The modules are displayed in chronological order, with the most recently removed module always being in index position 1. If the number of modules removed exceeds the capacity of the table, the oldest entries are deleted.

If a module is removed before the "plug-and-play" data is read in, the type, name, and serial number are blank.

Each row of this table is made up of the following variables:

Variable	Description
p2RemoveModuleIndex	The index for this table. The most recently removed module is always in index position 1.
p2RemoveModuleChassisID	The chassis ID number of the removed module.
p2RemoveModuleSlotID	The slot ID number of the removed module.
p2RemoveModuleName	The name of the removed module. This is the name from the plug-and-play data for this module, and matches what the ICIM and SNMP display as the name. TNCS and LCI may use a different name.
p2RemoveModuleType	The TNCS type number of the removed module. This number uniquely identifies every type of module.
p2RemoveModuleSerialNum	The serial number of the removed module. This information is needed to determine if a module has been replaced with one that is the same type.

Previous IP Address

This variable is named p2PreviousIP. When the IP of the ICIM is changed using the front panel, this variable returns the previous ICIM IP address. It returns 0.0.0.0 until the IP address of the ICIM is changed for the first time.

Boot Dialog for ICIM/SNMP Configuration

The boot dialog is presented whenever the ICIM is powered up (a cold boot). It is accessible via the LCI communications port on the front of the chassis.

Important: A null modem is required along with a terminal emulator program, such as HyperTerminal on a Windows PC.

The serial port on the PC used by the terminal emulator program should be set up with these parameters:

- 9600 baud
- 8 data bit
- No parity bit
- 1 stop bit

This parameter is often displayed as: 9600 8-N-1.

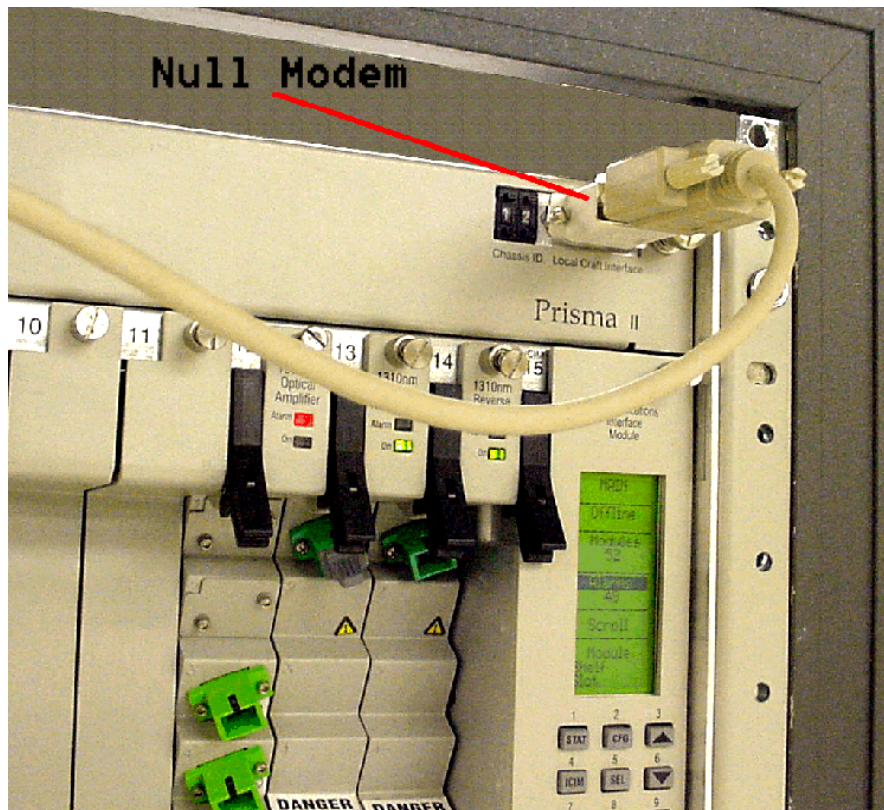

The primary use of the boot dialog is to flash a new version of the ICIM application via a TFTP server.

Important: Do this only under the direction of Cisco Services.

During a flash operation, the low-level parameters can be changed, including community strings, port number for traps, IP address, etc.

The procedures below initially tell the ICIM that it is to be updated (flashed), whereupon it presents a configuration dialog. After new values are entered and saved, the ICIM is told to **not** update the program and proceed to normal ICIM operations.

To Prepare to Change Parameters

- 1 When the ICIM is powered up, it presents a summary screen along with a prompt to "...press any key within 5 seconds." The following information appears:

```
Start-Up Configuration Dialog
Copyright (c) 2000 - 2004, Cisco Systems, Inc.
-----
START-UP MODE:
  Run ICIM Application
NETWORK INTERFACE PARAMETERS:
  IP address on LAN is 192.133.194.219
  LAN interface's subnet mask is 0xffffffff00
SNMPv1 COMMUNITY:
  Read Community: public      Write Community: private
  Trap Community: SNMP_trap   Trap Port: 162
HARDWARE PARAMETERS:
  Serial channels will use a baud rate of 9600
  Board's Serial Number is ^AIIJHC
HARDWARE PARAMETERS:
  ICIM BSP Revision: ICIM Boot Rom, Rev: BT 0204 (02-23-2004)
  MPC860 (Rev 0.2) CPU running at 49 Mhz with 5 Mhz input clock
  ICIM Board with 16 Mbytes DRAM and 4 Mbytes App FLASH and 2 Mbytes Boot
  FLASH
  This board's Ethernet hardware address is 0:2:DE:1:2:3
BOOT ROM PARAMETERS:
  IP address of the TFTP host is 192.133.194.4
  The file to download and start is ram.crc
  After board is reset, start-up code will wait 5 seconds
-----
To change any of this, press any key within 5 seconds.
```

Note: During the first couple of seconds, the ICIM does not respond to a key press.

- 2 Press any key repeatedly until the following prompt appears.

```
(M)odify any of this or (C)ontinue? [M]
```

- 3 Press **Enter** to get the default value for Modify.

```
For each of the following questions, you can press < Return > to
select the value shown in braces, or you can enter a new value.
How should the board boot?
1. pROBE+ (for debugging)
2. TFTP (for code download)
3. Run ICIM Application
Which one do you want? [3] 2
```

- 4 Select **2** for TFTP.

Note: We will **not** be doing a code download, but this gets access to the rest of the parameters dialog.

To Change Parameters

Below is an example dialog where one of the parameters (Trap Community) is changed. Any of the parameters can be changed, although some should be changed only with the advice of a Cisco Services representative.

Note: Hardware parameters (serial channel baud rate, serial number, and board Ethernet address) should **not** be changed.

```

NETWORK INTERFACE PARAMETERS:
Do you want a LAN interface? [Y]
This board's LAN IP address(0.0.0.0 = RARP)? [192.133.194.219]
Subnet mask for LAN (0 for none)? [255.255.255.0]
Should there be a default gateway for packet routing? [Y]
What is its IP address? [192.133.194.254]
SNMP COMMUNITY STRINGS:
Read Community [public]
Write Community [private]
Trap Community [SNMP_trap] ICIM_Trap
Trap Port for P2 traps [162]
HARDWARE PARAMETERS:
Baud rate for serial channels [9600]
Enter the Serial number? [^AAIJHC]
HARDWARE PARAMETERS:
Do you want to change the board's Ethernet address? [N]
BOOT ROM PARAMETERS:
IP address of the TFTP Boot server to boot from? [192.133.194.4]
What is the name of the file to be loaded and started? [ram014.crc]
How long (in seconds) should CPU delay before starting up? [5]

```

Each time a prompt is given, the default value is displayed in square brackets.

- 1 Press **Enter** to retain the current value and move onto the next parameter.

Note: As an example in the above screen, the Trap Community string has been changed to a new value. The prompt for delay time is the last one before the summary screen is presented.

- 2 Press any key repeatedly until the following prompt appears.

```
(M)odify any of this or (C)ontinue? [M]
```

- 3 Press **Enter** to get the default value for Modify.

To Restart the ICIM using ICIM

The boot selection dialog appears again.

```

For each of the following questions, you can press < Return > to select the
value shown in braces, or you can enter a new value.
How should the board boot?
1. pROBE+ (for debugging)
2. TFTP (for code download)
3. Run ICIM Application
Which one do you want? [2] 3

```

- 1 Select **3** to indicate that the normal ICIM application should be run (instead of TFTP). The summary page appears.
- 2 Do nothing and when the 5 second timeout expires, the ICIM restarts normally.

Adjusting Alarm Thresholds

To Adjust Alarm Thresholds

Relative alarm thresholds are both displayed and stored as relative values. This method for adjusting alarm thresholds lets you choose any valid increment size and adjust the alarm threshold to any valid value.

You can use the ICIM to change the adjustable alarm thresholds of this module from their factory default values.

- 1 At the MODULE menu, press the **STAT** key. The STATUS menu appears on the ICIM LCD.
- 2 Press the **SEL** key. The alarm thresholds previously set are displayed. If the label **n/a** is displayed, you cannot configure that alarm threshold. Press the **▼** key to highlight the alarm threshold for the next parameter.
- 3 When the threshold that you wish to set is highlighted, press the **ENTER** key.
- 4 Press the **▼** key or the **▲** key to change the increment size.
- 5 Press the **+** key or the **-** key to adjust the alarm threshold.
Note: Press the Cancel (**ALRM**) key to return to the previous menu.
- 6 Press the **ENTER** key to save the changes. The message **Data Saved** appears on the ICIM LCD.
- 7 When finished, press the **MAIN** key to return to the MAIN menu.

4

Operation Using LCI

The installation steps and procedures in this chapter apply if you are using the local craft interface (LCI) to configure and operate this module.

This chapter contains LCI installation instructions and procedures for using the LCI to view and, in some cases, modify module operating parameters.



WARNING:

Avoid damage to your eyes! Do not look into any optical connector while the system is active. Even if the unit is off, there may still be hazardous optical levels present.

In This Chapter

■ LCI Introduction	68
■ System Requirements	69
■ Installing LCI.....	70
■ Connecting Your Computer to the Chassis.....	74
■ Starting LCI Software.....	75
■ LCI Module Tree	77
■ Accessing Module Details	78
■ Checking the Operating Status	85
■ Configuring the Module using LCI.....	87
■ Checking the Module Alarms using LCI.....	89
■ Modifying Module Alarm Limits using LCI.....	91
■ Checking Manufacturing Data using LCI	93

LCI Introduction

Laser Warning



WARNING:

- **Avoid personal injury!** Use of controls, adjustments, or procedures other than those specified herein may result in hazardous radiation exposure.
 - **Avoid personal injury!** The laser light source on this equipment (if a transmitter) or the fiber cables connected to this equipment emit invisible laser radiation. Avoid direct exposure to the laser light source.
 - **Avoid personal injury!** Viewing the laser output (if a transmitter) or fiber cable with optical instruments (such as eye loupes, magnifiers, or microscopes) may pose an eye hazard.
-
- Do not apply power to this equipment if the fiber is unmated or unterminated.
 - Do not stare into an unmated fiber or at any mirror-like surface that could reflect light emitted from an unterminated fiber.
 - Do not view an activated fiber with optical instruments such as eye loupes, magnifiers, or microscopes.
 - Use safety-approved optical fiber cable to maintain compliance with applicable laser safety requirements.
 - Even if the unit is off, there may still be hazardous optical levels present.

LCI Function

LCI is software that functions as a user interface for the Prisma II platform. LCI is installed on a computer, which is then connected to a Prisma II Chassis. Using LCI, you can configure and monitor the modules in the chassis to which the computer is connected.

Important: Do not operate any Prisma II Chassis without a fan tray installed. If a fan tray is not installed in the Prisma II Chassis, the LCI will not communicate with any of the power supplies in that chassis.

System Requirements

You will need the following computer software and hardware to run LCI.

Computer Requirements

- Pentium II 300 MHz processor or equivalent
- 128 MB RAM
- 10 MB available hard drive space
- CD-ROM Drive
- Windows 95 or later operating system software

Cable Requirements

The required cable is a standard serial extension cable, DB9 Female to DB9 Male. This cable can be purchased locally or ordered from the factory as part number 180143. The connectors are a serial 9-pin D-shell (EIA 574/232).

Installing LCI

This section describes how to install your LCI software.

To Install the LCI Software

Complete the following steps to install the LCI software.

- 1 Obtain the LCI installation program from www.cisco.com/support and copy the program file to your Windows desktop.

Note: If you need help locating the LCI installation program, contact Cisco Services at 1-800-283-2636 for assistance.

- 2 Launch the LCI installation program. The Welcome screen appears as shown in the following illustration.

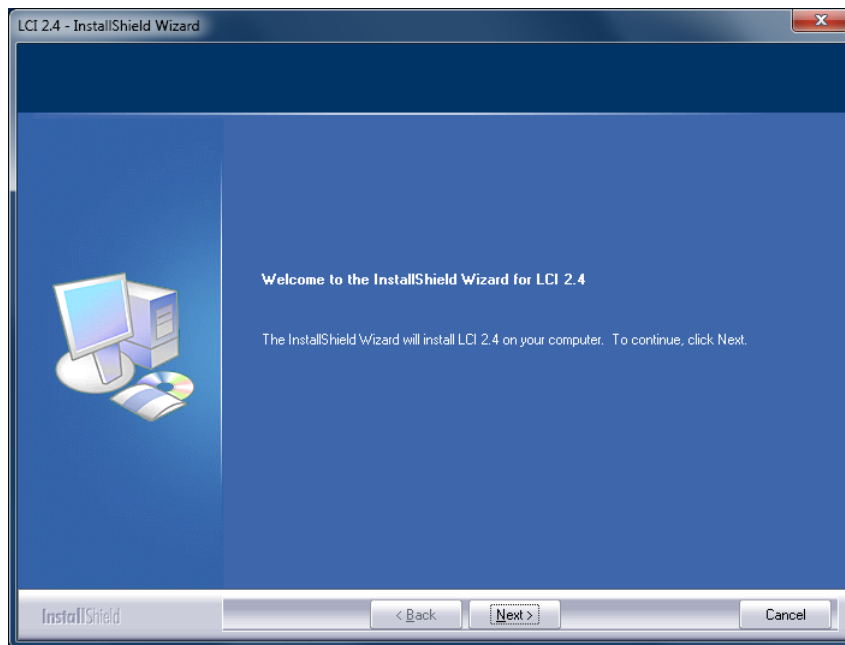

- 3 Click **Next** to continue with the installation process. The Ready to Install the Program screen appears as shown in the following illustration.

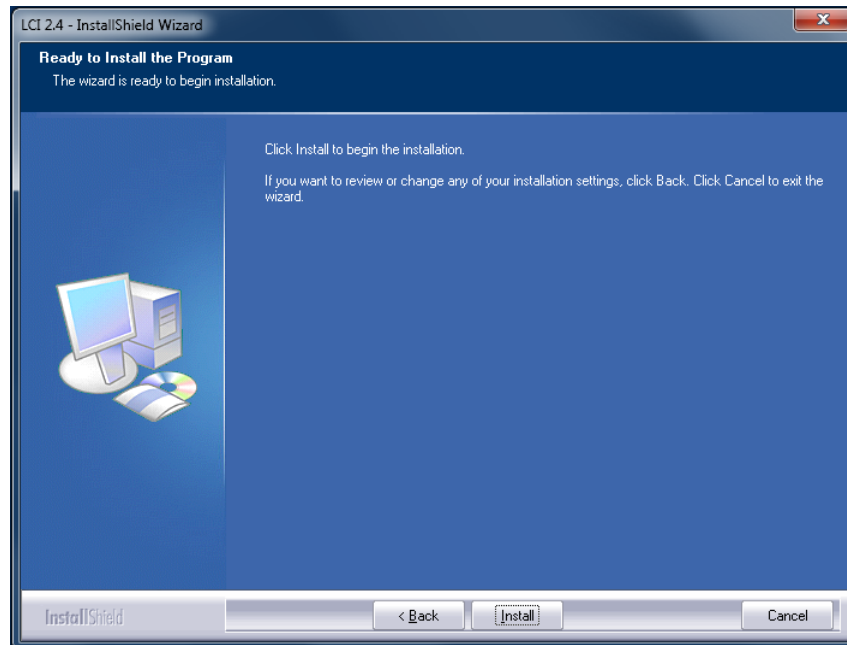

- 4 Click **Install** to begin installation. After a moment, the Setup Status screen appears, displaying a progress indicator as shown in the following illustration.

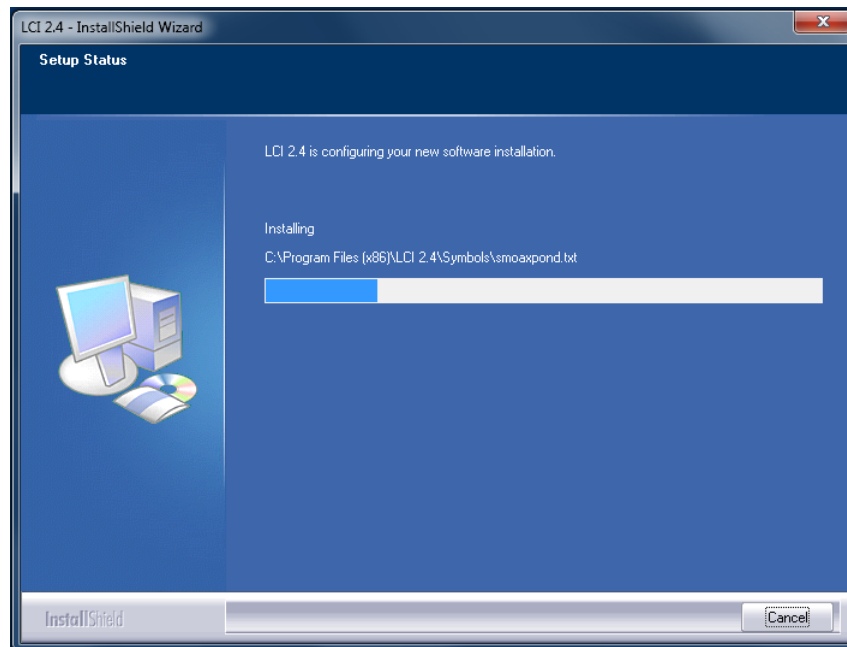

- 5 When finished, the wizard asks if you want to install the Silicon Labs driver, which is required when using LCI with a node product.
 - If you are using LCI with a node product, choose the **Launch** option, click **Next**, and follow steps of the wizard to install the driver.

- If you are not using LCI with a node product, choose the **Exit Installation** option and then click **Next**.

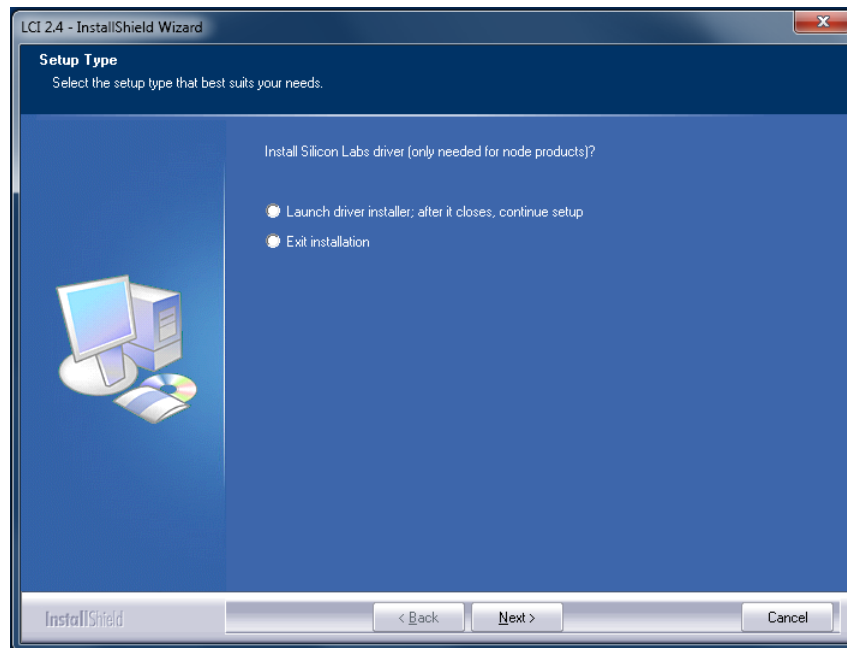

- 6 When finished, the InstallShield Wizard Complete screen appears as shown in the following illustration.

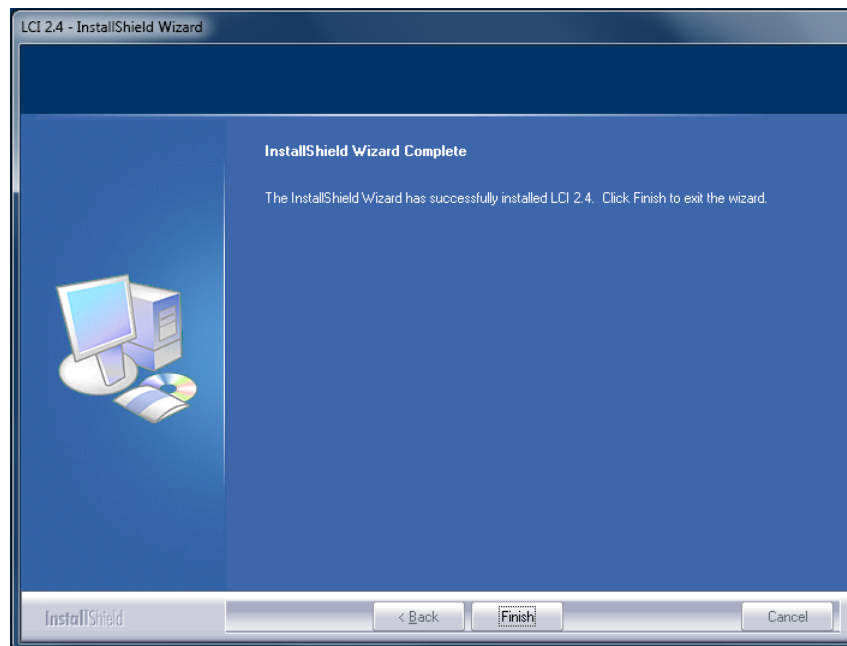

- 7 Click **Finish** to exit the Install wizard. An LCI shortcut is placed on your Windows desktop as shown in the following illustration.



The LCI software is now ready to use.

Connecting Your Computer to the Chassis

Before you start LCI, you must first connect your computer to the chassis that contains the module(s) you want to check.

Important:

- LCI only communicates with modules installed in the chassis to which your computer is connected. To check other modules, you must connect your computer to the chassis in which they are installed.
- If LCI does not communicate with a module in the chassis to which your computer is connected, it may be necessary to update the LCI application.

To Connect a Computer to the Chassis

Complete the following steps to connect your computer to the chassis.

- 1 Plug one end of a 9-pin RS-232 serial extension cable into your computer.
- 2 Plug the other end of the cable into the LCI port, labeled **Local Craft Interface**.

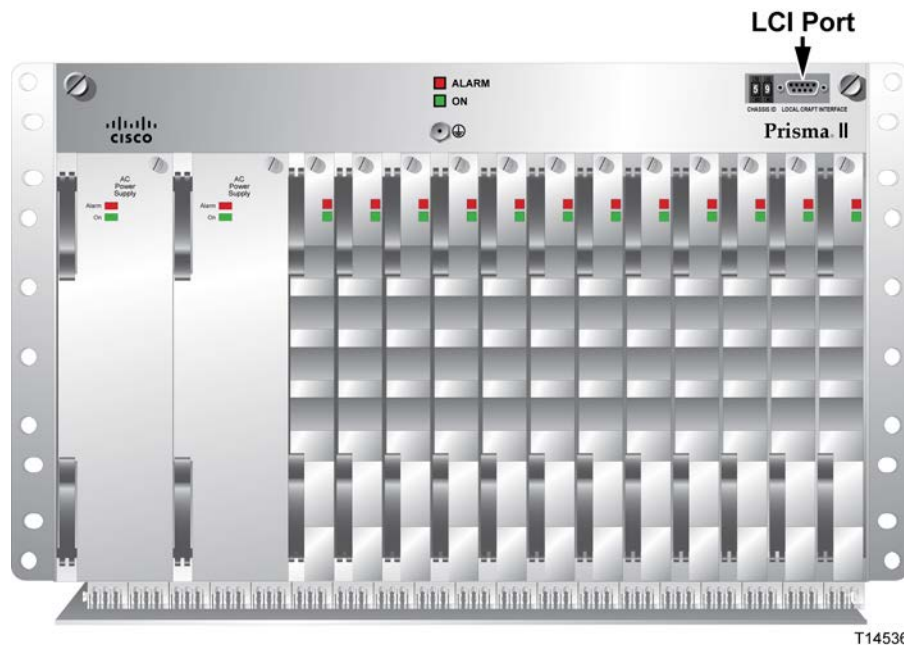

Starting LCI Software

When you start LCI, it polls the module(s) located in the chassis to which your computer is attached. For each module it finds, LCI does the following:

- Represents the module in the module tree of the main LCI window
- Makes the polling information available so you can check and configure various parameters

Important: Your computer must be connected to the chassis before you start LCI. For instructions, refer to *Connecting Your Computer to the Chassis* (on page 74).

To Start LCI Software

Complete the following steps to start the LCI software.

- 1 Double-click the LCI icon on your Windows desktop.



Result: The LCI Detect Configuration window appears as shown below.

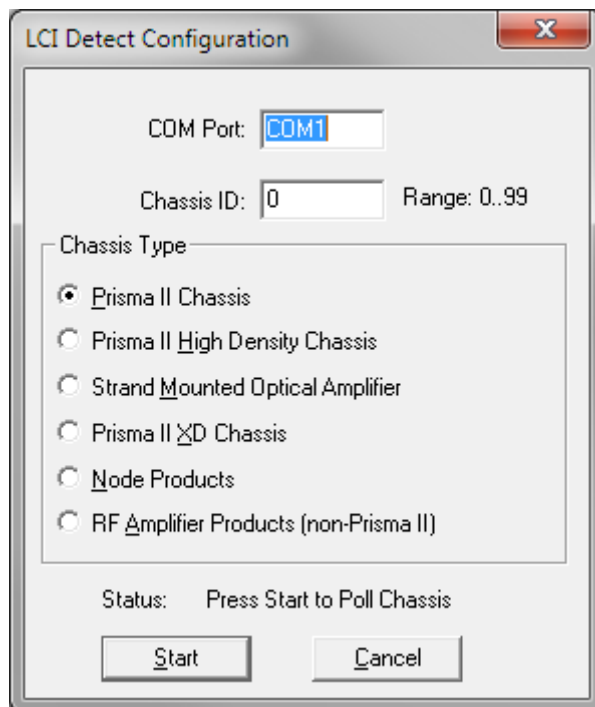

- 2 In the LCI Detect Configuration window, select the appropriate COM port, chassis ID, and chassis type, and then click **Start**.

Result: LCI polls the modules in the chassis, and when finished, displays a Refresh Complete message.

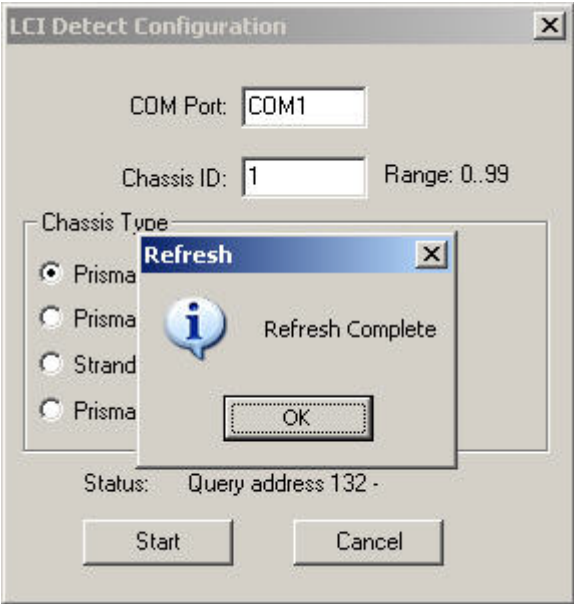

- 3 Click OK to continue with LCI startup.

Result: The main LCI window appears as shown in the example below.

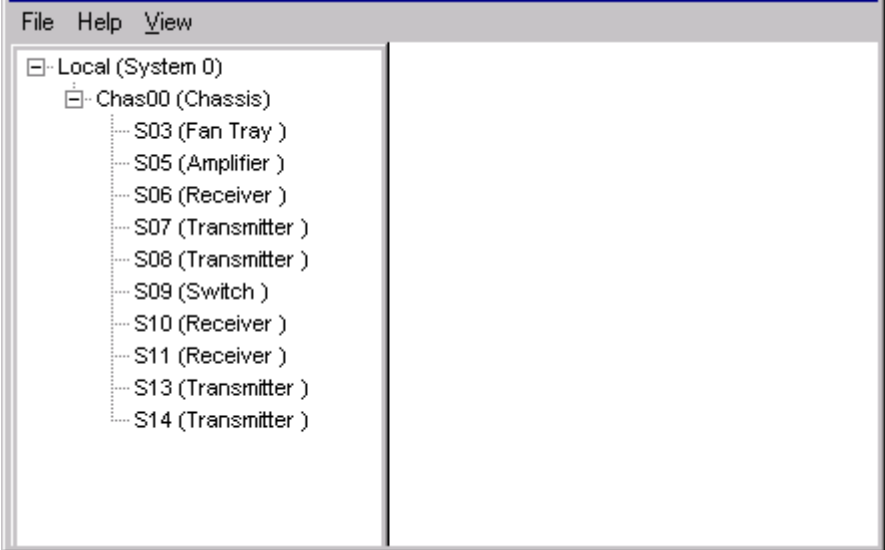

LCI Module Tree

Introduction

The LCI main window contains a tree that represents your system in a hierarchical manner.

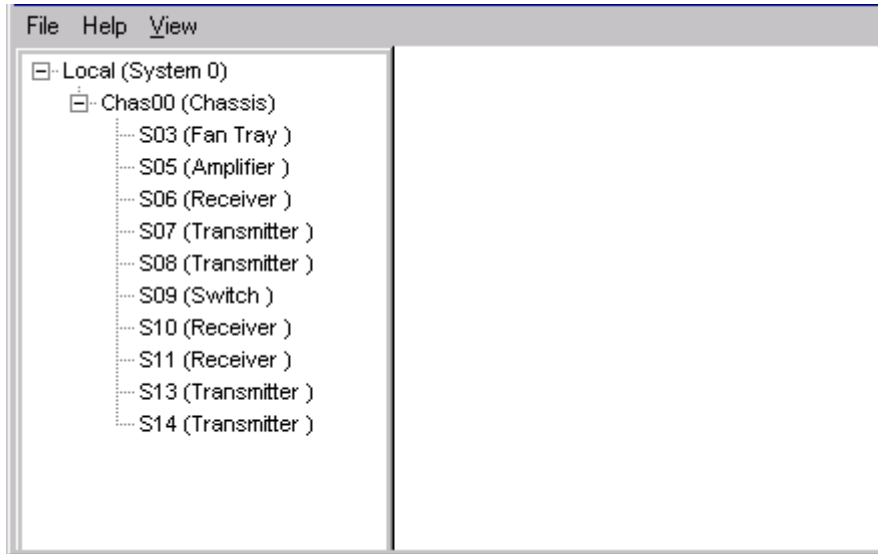

Module Tree Levels

In the illustration above, the module tree represents a computer connected to a chassis that contains ten modules. The three tree levels are described in the following table.

Module Tree Level	Description
Local (System 0)	Computer being used
Chas00 (Chassis)	Chassis to which the computer is connected
Sxx (Module name)	Module(s) located within the chassis. Each module is of the format <i>chassis slot location (module name)</i> . Example: In the illustration above, S08 (Transmitter) represents a 1550 nm transmitter located in slot 8 of the chassis.

Accessing Module Details

The Module Details window displays information about module parameters, alarms, and status. You can access this window from the module tree using one of several methods:

- Double-click the chassis to display a graphic image of the chassis, and then double-click the module in the graphic.
- Right-click the chassis in the module tree to display a context menu, and then choose **Open** from the menu.
- Right-click the module in the module tree to display a context menu, and then select **Details** from the menu.
- Double-click the module in the module tree.

The procedures in this chapter show the module right-click method. In practice, use the method that you find most convenient.

Module Details Window

The following illustration shows the Module Details window for a Prisma II 1550 nm TXX EMT Transmitter.

The screenshot shows a software window titled "1550 EMT Transmitter" with a blue title bar. The window is divided into several sections:

- Parameters:** A table with columns: Present Value, Present Status, Nominal Value, Minor-Alarm Low-Limit, Minor-Alarm High-Limit, Major-Alarm Low-Limit, Major-Alarm High-Limit, and units.

	Present Value	Present Status	Nominal Value	Minor-Alarm Low-Limit	Minor-Alarm High-Limit	Major-Alarm Low-Limit	Major-Alarm High-Limit	Units
Laser Bias	329.1	Normal	328.8	-250	50	-.300	100	mA
Laser Temperature	24.2	Normal	25.0	-10	10	-.15	15	deg-C
Module Temperature	33.3	Normal	n/a	-21	78	-.36	85	deg-C
Modulator Bias	0.23	Normal	0.17	-5.00	5.00	-.9.50	9.50	Volts
SBS 2GHz Power	74.0	Normal	n/a	10.0	400.0	5.0	405.0	
SBS 6GHz Power	123.5	Normal	n/a	10.0	400.0	5.0	405.0	
CP Lock	0.2	Normal	n/a	50	50	-.100	100	
RF Input	0.0	Normal	n/a	-1.0	1.0	-.3.0	3.0	dB
Optical Output 1 Power	10.8	Normal	n/a	5.0	13.0	2.5	15.0	dBm
-5V Supply Voltage	-5.1	Normal	n/a	-5.5	-4.5	-.6.0	4.0	Volts
-12V Supply Voltage	-12.0	Normal	n/a	-13.0	-11.0	-.14.0	10.0	Volts
+12V Supply Voltage	12.0	Normal	n/a	11.0	13.0	10.0	14.0	Volts
- Alarms:** Summary Status Normal, Communication Status Normal, Power Supply Status Normal, Laser Enabled Status Normal, PL Lock Normal.
- Status:** Optical Output 2 Power 10.8 dBm, TEC Current 0.3 A, SBS 2GHz PLL Lock, SBS 6GHz PLL Lock, Tx Type TXX.
- Controls:** Enable Laser On, Laser Mode Constant-Power, AGC Mode Off, RF Drive Setting 0.0 dB, OMI Level Setting 0.0 dB, Master Master, RFLasSet Off, Length 110.0 km.
- Properties:** Devtype Revision 1.00, Name S07, Graphic, Service Name, Symbol, Device Location, M&C-Scan On-Scan, Maintenance Mode Normal, Poll Counter 76, Script, Comm Alarm Threshold 1, Address 7, Port COM1, Generic Name Transmitter, Description 1550 EMT Transmitter, Software Revision 6.13, Script Version 1431, Serial Number KKAAlKXK, Time Of Service 3 Hrs, Day Code D09, Module Type 1040.

The following illustration shows the Module Details window for a Prisma II 1550 nm TXL EMT Transmitter.

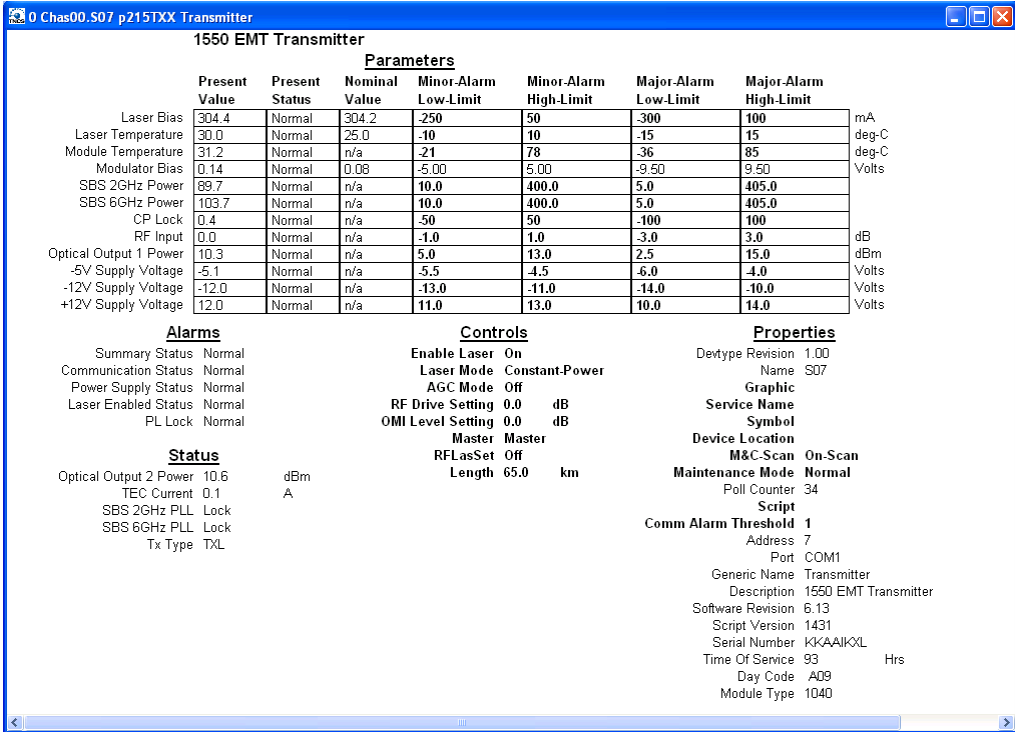

The following illustration shows the Module Details window for a Prisma II 1550 nm TXR (Reverse) Transmitter.

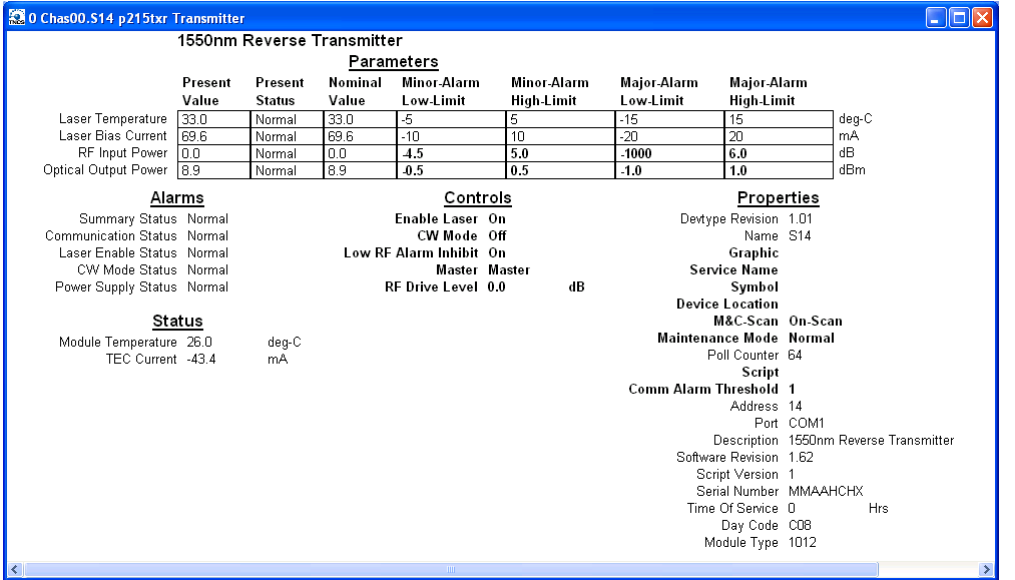

To Access the Module Details, Double-Click the Chassis

- 1 Double-click the chassis.

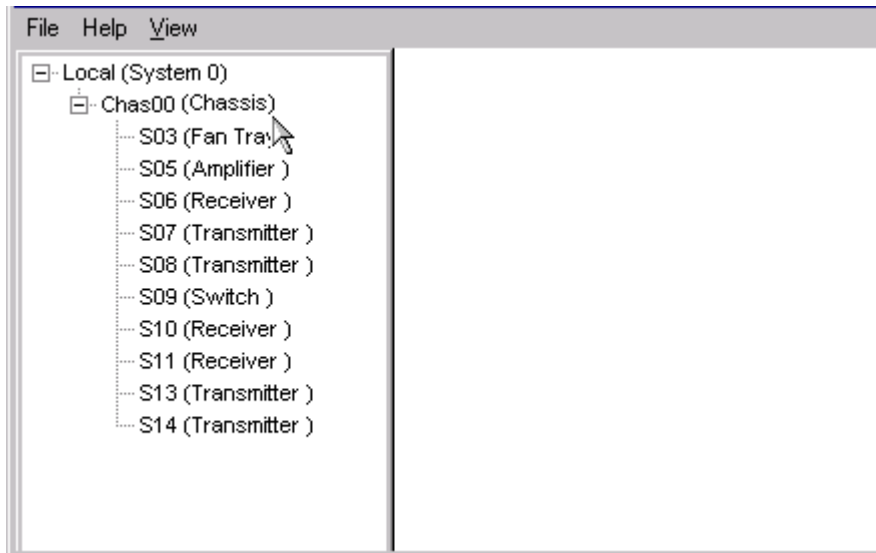

Result: A graphic representation of the chassis appears.

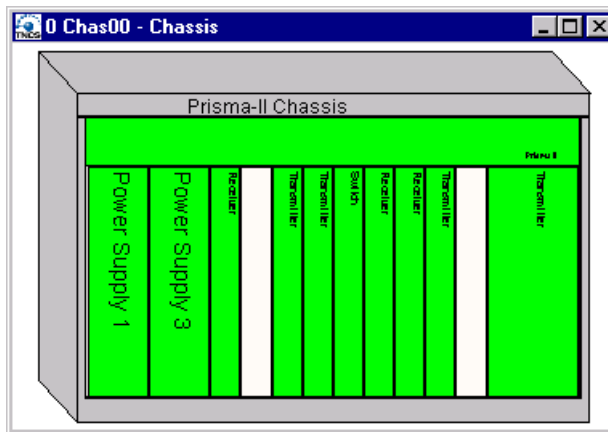

- 2 Double-click the module whose information you want to view or configure.

Result: The Module Details window appears.

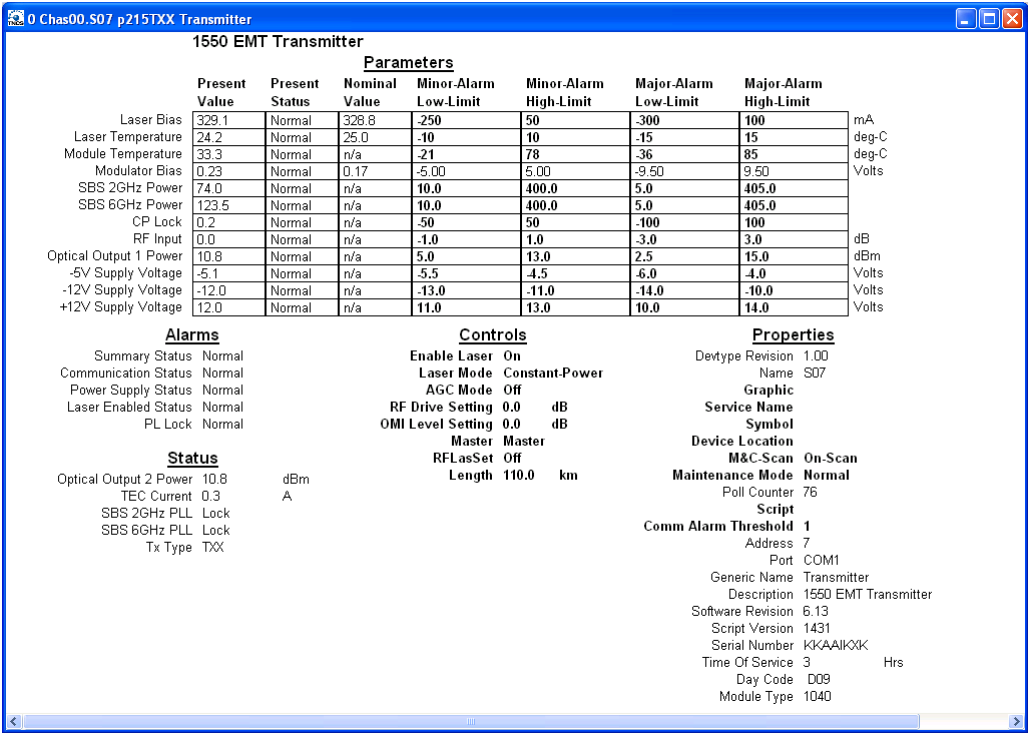

3 Proceed with viewing or configuring information.

To Access the Module Details, Right-Click the Chassis

1 Right-click the chassis, and then click Open.

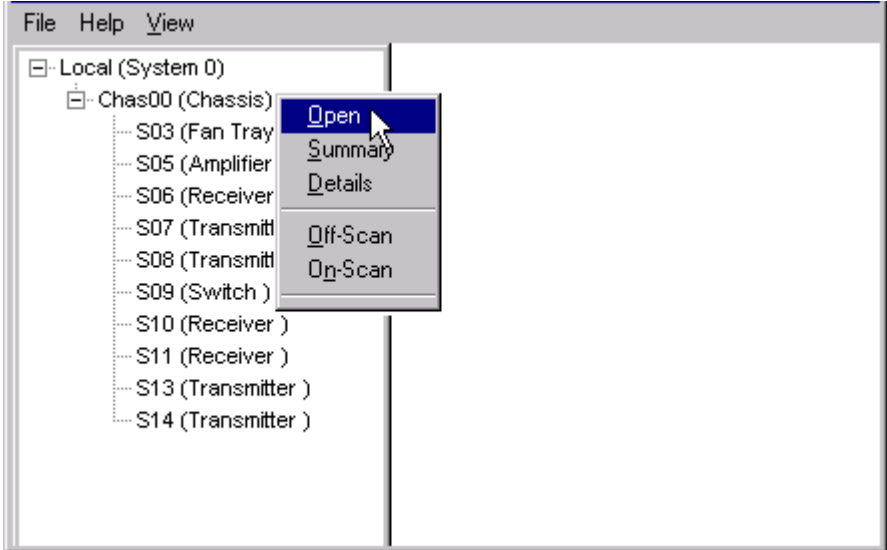

Result: A graphic representation of the chassis appears.

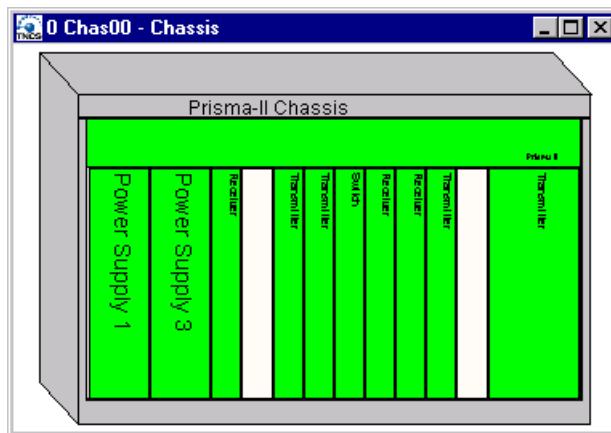

- 2 Double-click the module whose information you want to view or configure.

Result: The Module Details window appears.

1550 EMT Transmitter

	Present Value	Present Status	Nominal Value	Minor-Alarm Low-Limit	Minor-Alarm High-Limit	Major-Alarm Low-Limit	Major-Alarm High-Limit	
Laser Bias	329.1	Normal	328.8	-250	50	-300	100	mA
Laser Temperature	24.2	Normal	25.0	-10	10	-15	15	deg-C
Module Temperature	33.3	Normal	n/a	-21	78	-36	85	deg-C
Modulator Bias	0.23	Normal	0.17	-5.00	5.00	-9.50	9.50	Volts
SBS 2GHz Power	74.0	Normal	n/a	10.0	400.0	5.0	405.0	
SBS 6GHz Power	123.5	Normal	n/a	10.0	400.0	5.0	405.0	
CP Lock	0.2	Normal	n/a	50	50	-100	100	
RF Input	0.0	Normal	n/a	-1.0	1.0	-3.0	3.0	dBm
Optical Output 1 Power	10.8	Normal	n/a	5.0	13.0	2.5	15.0	dBm
-5V Supply Voltage	-5.1	Normal	n/a	5.5	-4.5	-6.0	-4.0	Volts
-12V Supply Voltage	-12.0	Normal	n/a	-13.0	-11.0	-14.0	-10.0	Volts
+12V Supply Voltage	12.0	Normal	n/a	11.0	13.0	10.0	14.0	Volts

Alarms

Summary Status	Normal
Communication Status	Normal
Power Supply Status	Normal
Laser Enabled Status	Normal
PL Lock	Normal

Controls

Enable Laser	On
Laser Mode	Constant-Power
AGC Mode	Off
RF Drive Setting	0.0 dB
OMI Level Setting	0.0 dB
Master	Master
RFLasSet	Off
Length	110.0 km

Properties

Devtype Revision	1.00
Name	S07
Graphic	
Service Name	
Symbol	
Device Location	
M&C-Scan	On-Scan
Maintenance Mode	Normal
Poll Counter	76
Script	
Comm Alarm Threshold	1
Address	7
Port	COM1
Generic Name	Transmitter
Description	1550 EMT Transmitter
Software Revision	6.13
Script Version	1431
Serial Number	KKAAIKXX
Time Of Service	3 Hrs
Day Code	D09
Module Type	1040

- 3 Proceed with viewing or configuring information.

To Access the Module Details, Double-Click the Module

- 1 Double-click the module.

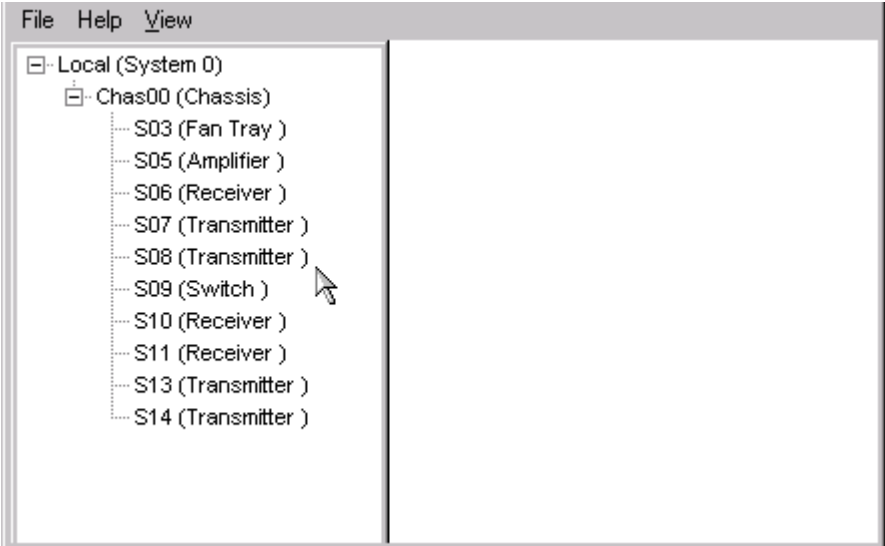

Result: The Module Details window appears.

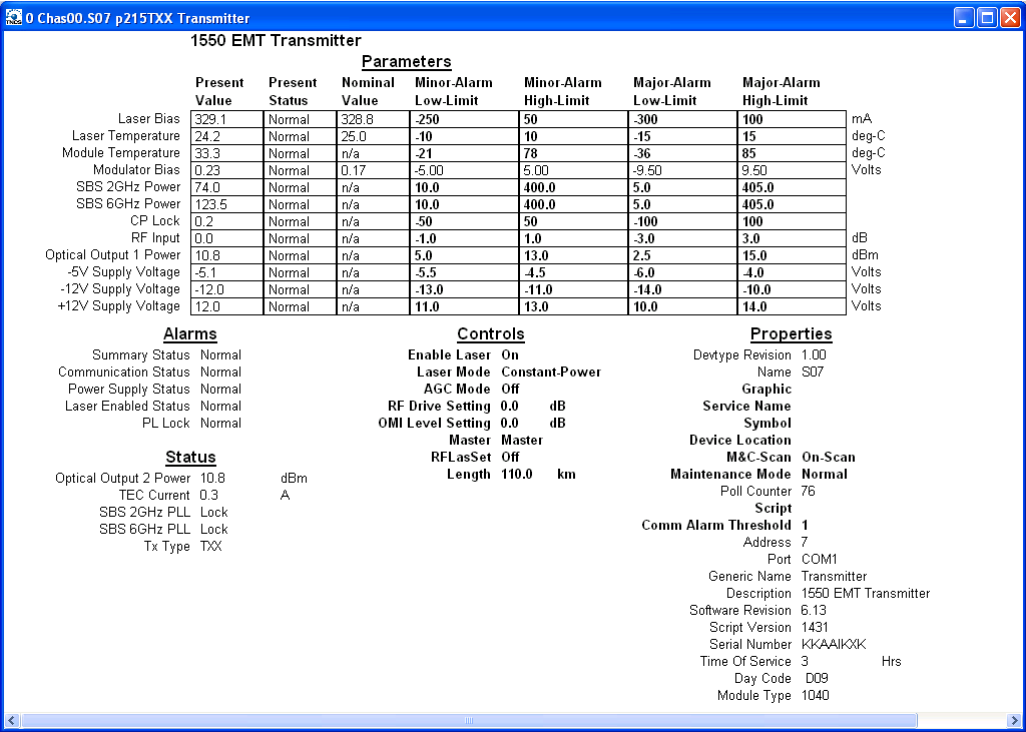

- 2 Proceed with viewing or configuring information.

To Access the Module Details, Right-Click the Module

- 1 Right-click the module, and then click **Details**.

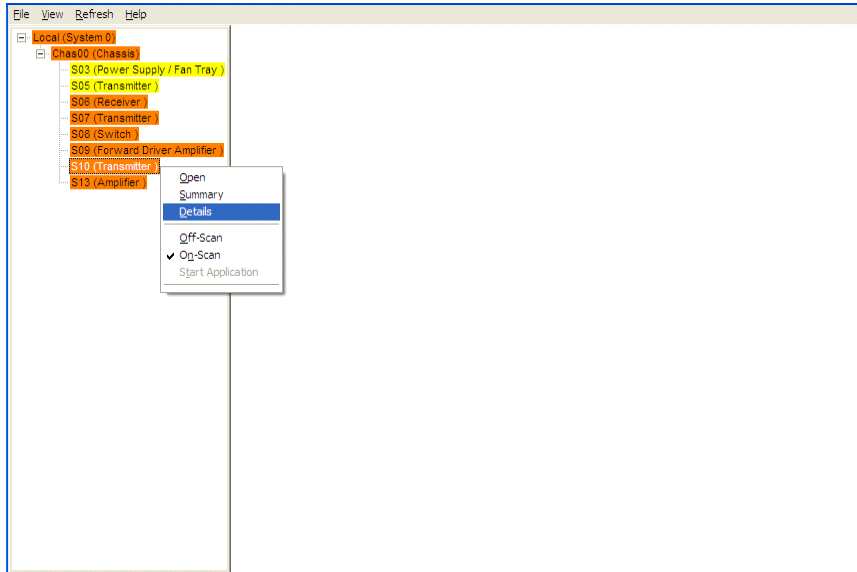

Result: The Module Details window appears.

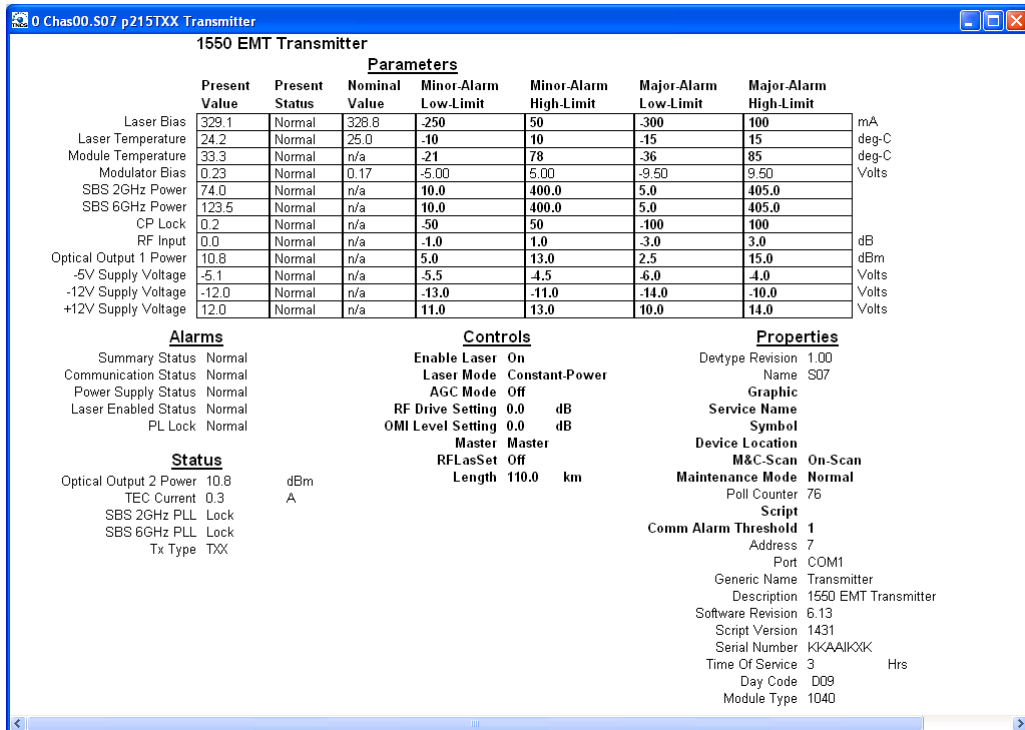

- 2 Proceed with viewing or configuring information.

Checking the Operating Status

To Check the Operating Status using LCI

Using the LCI, you can check the status of all module operating parameters.

- 1 In the module tree, right-click the module, and then click **Details**.

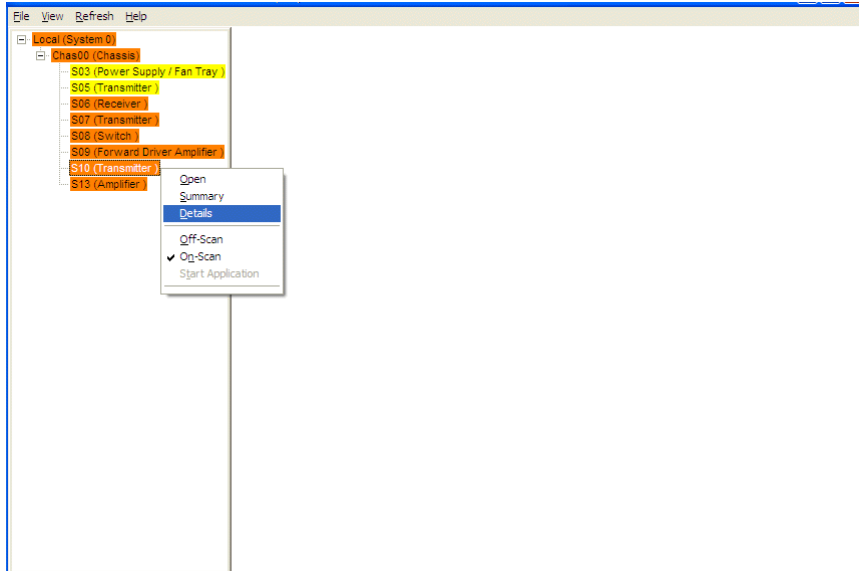

The Module Details window appears as shown in the following example. The monitored parameters are displayed under **Parameters** and **Status**.

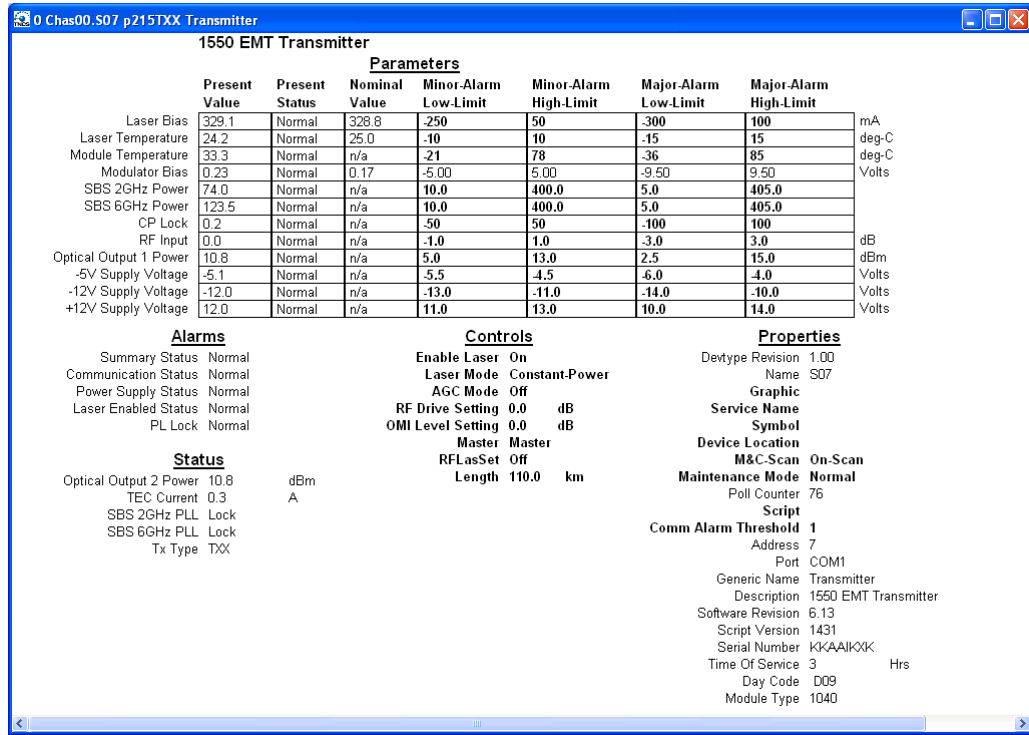

2 Check the operating parameters.

Note: For details on all operating status parameters, see *Module Parameter Descriptions* (on page 105).

Configuring the Module using LCI

To Configure Parameters using LCI

Using LCI, you can configure any module parameters that allow for such changes.

- 1 In the module tree, right-click the module, and then click **Details**.

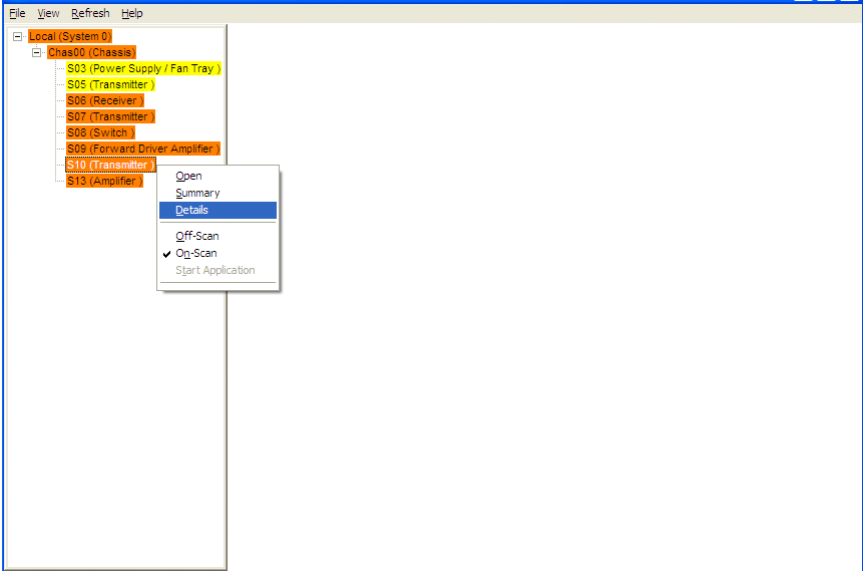

The Module Details window appears as shown in the following example.

0 Chas00.S07 p215TX Transmitter

1550 EMT Transmitter

	Present Value	Present Status	Nominal Value	Minor-Alarm Low-Limit	Minor-Alarm High-Limit	Major-Alarm Low-Limit	Major-Alarm High-Limit	
Laser Bias	329.1	Normal	328.8	-250	50	-300	100	mA
Laser Temperature	24.2	Normal	25.0	-10	10	-15	15	deg-C
Module Temperature	33.3	Normal	n/a	-21	78	-36	85	deg-C
Modulator Bias	0.23	Normal	0.17	-5.00	5.00	-9.50	9.50	Volts
SBS 2GHz Power	74.0	Normal	n/a	10.0	400.0	5.0	405.0	
SBS 6GHz Power	123.5	Normal	n/a	10.0	400.0	5.0	405.0	
CP Lock	0.2	Normal	n/a	-50	50	-100	100	
RF Input	0.0	Normal	n/a	-1.0	1.0	-3.0	3.0	dB
Optical Output 1 Power	10.8	Normal	n/a	5.0	13.0	2.5	15.0	dBm
-5V Supply Voltage	-5.1	Normal	n/a	-5.5	-4.5	-6.0	-4.0	Volts
-12V Supply Voltage	-12.0	Normal	n/a	-13.0	-11.0	-14.0	-10.0	Volts
+12V Supply Voltage	12.0	Normal	n/a	11.0	13.0	10.0	14.0	Volts

Alarms

Summary Status Normal
 Communication Status Normal
 Power Supply Status Normal
 Laser Enabled Status Normal
 PL Lock Normal

Status

Optical Output 2 Power 10.8 dBm
 TEC Current 0.3 A
 SBS 2GHz PLL Lock
 SBS 6GHz PLL Lock
 Tx Type TX

Controls

Enable Laser On
 Laser Mode Constant-Power
 AGC Mode Off
 RF Drive Setting 0.0 dB
 OMI Level Setting 0.0 dB
 Master Master
 RFLasSet Off
 Length 110.0 km

Properties

Devtype Revision 1.00
 Name S07
 Graphic
 Service Name
 Symbol
 Device Location
 M&C-Scan On-Scan
 Maintenance Mode Normal
 Poll Counter 76
 Script
 Comm Alarm Threshold 1
 Address 7
 Port COM1
 Generic Name Transmitter
 Description 1550 EMT Transmitter
 Software Revision 6.13
 Script Version 1431
 Serial Number K4AAIKXK
 Time Of Service 3 Hrs
 Day Code D09
 Module Type 1040

- 2 Under **Controls**, double-click the parameter you want to configure. The Change Value Dialog box appears. This example shows the dialog box for the RF Drive Setting parameter.

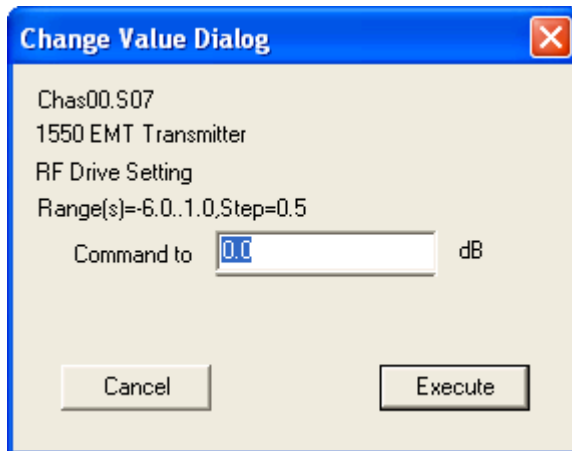

- 3 Depending on the parameter you chose, select or type a new value.
- 4 Click **Execute**. The new value appears next to the parameter.

Note: For details on all configurable parameters, see *Module Parameter Descriptions* (on page 105).

Checking the Module Alarms using LCI

Using LCI, you can check the alarm status of various parameters. Alarms limits fall into one of the following categories.

- Major low
- Minor low
- Minor high
- Major high

To Check Alarms using LCI

Right-click the module, and then click **Details**.

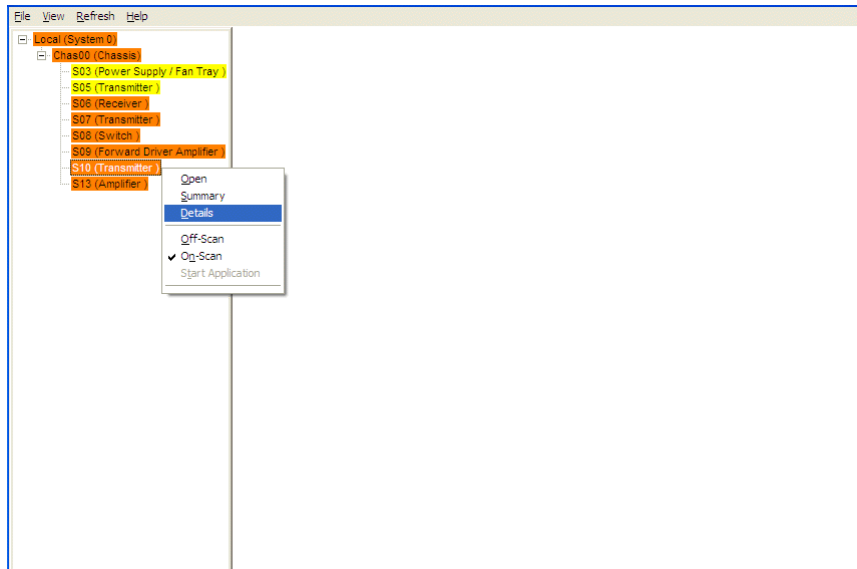

The Module Details window appears as shown in the following example. The alarms are shown under **Parameters** and **Alarms**.

0 Chas00.S07 p215TXX Transmitter

1550 EMT Transmitter

Parameters							
	Present Value	Present Status	Nominal Value	Minor-Alarm Low-Limit	Minor-Alarm High-Limit	Major-Alarm Low-Limit	Major-Alarm High-Limit
Laser Bias	329.1	Normal	328.8	-250	50	-300	100
Laser Temperature	24.2	Normal	25.0	-10	10	-15	15
Module Temperature	33.3	Normal	n/a	-21	78	-36	85
Modulator Bias	0.23	Normal	0.17	-5.00	5.00	-9.50	9.50
SBS 2GHz Power	74.0	Normal	n/a	10.0	400.0	5.0	405.0
SBS 6GHz Power	123.5	Normal	n/a	10.0	400.0	5.0	405.0
CP Lock	0.2	Normal	n/a	-50	50	-100	100
RF Input	0.0	Normal	n/a	-1.0	1.0	-3.0	3.0
Optical Output 1 Power	10.8	Normal	n/a	5.0	13.0	2.5	15.0
-5V Supply Voltage	-5.1	Normal	n/a	-5.5	-4.5	-6.0	-4.0
-12V Supply Voltage	-12.0	Normal	n/a	-13.0	-11.0	-14.0	-10.0
+12V Supply Voltage	12.0	Normal	n/a	11.0	13.0	10.0	14.0

Alarms	Controls	Properties
Summary Status Normal	Enable Laser On	Devtype Revision 1.00
Communication Status Normal	Laser Mode Constant-Power	Name S07
Power Supply Status Normal	AGC Mode Off	Graphic
Laser Enabled Status Normal	RF Drive Setting 0.0 dB	Service Name
PL Lock Normal	OMI Level Setting 0.0 dB	Symbol
	Master Master	Device Location
	RFLasSet Off	M&C-Scan On-Scan
	Length 110.0 km	Maintenance Mode Normal
Status		Poll Counter 76
Optical Output 2 Power 10.8 dBm		Script
TEC Current 0.3 A		Comm Alarm Threshold 1
SBS 2GHz PLL Lock		Address 7
SBS 6GHz PLL Lock		Port COM1
Tx Type TXX		Generic Name Transmitter
		Description 1550 EMT Transmitter
		Software Revision 6.13
		Script Version 1431
		Serial Number KKAAlKXK
		Time Of Service 3 Hrs
		Day Code D09
		Module Type 1040

Note: For details on all alarm parameters, see *Module Parameter Descriptions* (on page 105).

Modifying Module Alarm Limits using LCI

To Modify Alarm Limits using LCI

Using LCI, you can modify alarm limits for parameters that allow for such changes.

- 1 In the module tree, right-click the module, and then click **Details**.

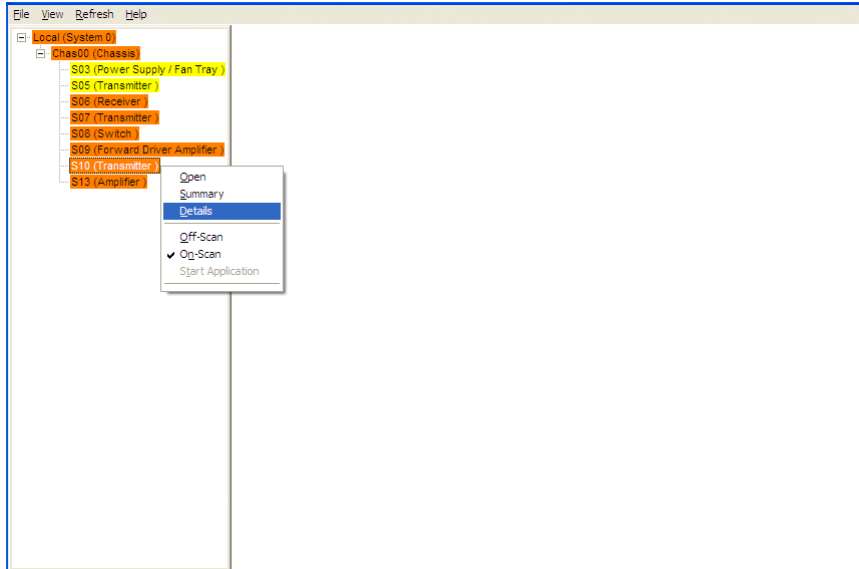

The Module Details window appears as shown in the following example. The alarm limits are shown under **Parameters**.

The screenshot shows the '1550 EMT Transmitter' window with the following sections:

Parameters								
	Present Value	Present Status	Nominal Value	Minor-Alarm Low-Limit	Minor-Alarm High-Limit	Major-Alarm Low-Limit	Major-Alarm High-Limit	
Laser Bias	329.1	Normal	328.8	-250	50	-300	100	mA
Laser Temperature	24.2	Normal	25.0	-10	10	-15	15	deg-C
Module Temperature	33.3	Normal	n/a	-21	78	-36	85	deg-C
Modulator Bias	0.23	Normal	0.17	-5.00	5.00	-9.50	9.50	Volts
SBS 2GHz Power	74.0	Normal	n/a	10.0	400.0	5.0	405.0	
SBS 6GHz Power	123.5	Normal	n/a	10.0	400.0	5.0	405.0	
CP Lock	0.2	Normal	n/a	50	50	-100	100	
RF Input	0.0	Normal	n/a	-1.0	1.0	-3.0	3.0	dB
Optical Output 1 Power	10.8	Normal	n/a	5.0	13.0	2.5	15.0	dBm
-5V Supply Voltage	-5.1	Normal	n/a	5.5	-4.5	-6.0	-4.0	Volts
-12V Supply Voltage	-12.0	Normal	n/a	-13.0	-11.0	-14.0	-10.0	Volts
+12V Supply Voltage	12.0	Normal	n/a	11.0	13.0	10.0	14.0	Volts

Alarms

- Summary Status: Normal
- Communication Status: Normal
- Power Supply Status: Normal
- Laser Enabled Status: Normal
- PL Lock: Normal

Status

- Optical Output 2 Power: 10.8 dBm
- TEC Current: 0.3 A
- SBS 2GHz PLL: Lock
- SBS 6GHz PLL: Lock
- Tx Type: TXX

Controls

- Enable Laser: On
- Laser Mode: Constant-Power
- AGC Mode: Off
- RF Drive Setting: 0.0 dB
- OMI Level Setting: 0.0 dB
- Master Master
- RFLasSet: Off
- Length: 110.0 km

Properties

- Devtype Revision: 1.00
- Name: S07
- Graphic
- Service Name
- Symbol
- Device Location
- M&C-Scan: On-Scan
- Maintenance Mode: Normal
- Poll Counter: 76
- Script
- Comm Alarm Threshold: 1
- Address: 7
- Port: COM1
- Generic Name: Transmitter
- Description: 1550 EMT Transmitter
- Software Revision: 6.13
- Script Version: 1431
- Serial Number: KKAAlKXX
- Time Of Service: 3 Hrs
- Day Code: DD9
- Module Type: 1040

- 2 Double-click the limit you want to change. This example shows a Change Value dialog box for the Laser Temperature Major High Limit parameter.

The 'Change Value Dialog' box displays the following information:

- Chas00.S07
- 1550 EMT Transmitter
- Laser Temperature Major High Limit
- Range(s)=0.0..50.0
- Command to:
- Buttons: Cancel, Execute

- 3 To change the limit value, type the desired value in the **Command to** box.
- 4 Click **Execute**. The new value appears in the alarm limit column.

Note: For details on all alarm limits, see *Module Parameter Descriptions* (on page 105).

Checking Manufacturing Data using LCI

To Check Manufacturing Data using LCI

Using LCI, you can check the manufacturing data for a selected module.

- 1 In the module tree, right-click the module, and then click **Details**.

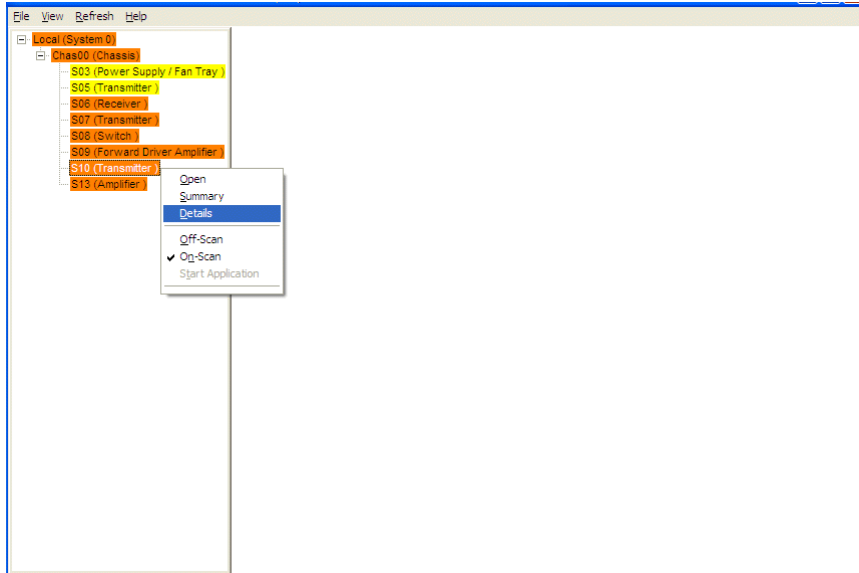

The Module Details window appears as shown in the following example. The manufacturing data is displayed under **Properties**.

The screenshot shows a software window titled "1550 EMT Transmitter" with a blue header bar. The main content area is divided into four sections: Parameters, Alarms, Controls, and Properties.

Parameters

	Present Value	Present Status	Nominal Value	Minor-Alarm Low-Limit	Minor-Alarm High-Limit	Major-Alarm Low-Limit	Major-Alarm High-Limit	
Laser Bias	329.1	Normal	328.8	-250	50	-300	100	mA
Laser Temperature	24.2	Normal	25.0	-10	10	-15	15	deg-C
Module Temperature	33.3	Normal	n/a	-21	78	-36	85	deg-C
Modulator Bias	0.23	Normal	0.17	-5.00	5.00	-9.50	9.50	Volts
SBS 2GHz Power	74.0	Normal	n/a	10.0	400.0	5.0	405.0	
SBS 6GHz Power	123.5	Normal	n/a	10.0	400.0	5.0	405.0	
CP Lock	0.2	Normal	n/a	50	50	-100	100	
RF Input	0.0	Normal	n/a	-1.0	1.0	-3.0	3.0	dB
Optical Output 1 Power	10.8	Normal	n/a	5.0	13.0	2.5	15.0	dBm
-5V Supply Voltage	-5.1	Normal	n/a	-5.5	-4.5	-6.0	-4.0	Volts
-12V Supply Voltage	-12.0	Normal	n/a	-13.0	-11.0	-14.0	-10.0	Volts
+12V Supply Voltage	12.0	Normal	n/a	11.0	13.0	10.0	14.0	Volts

Alarms

- Summary Status: Normal
- Communication Status: Normal
- Power Supply Status: Normal
- Laser Enabled Status: Normal
- PL Lock: Normal

Status

- Optical Output 2 Power: 10.8 dBm
- TEC Current: 0.3 A
- SBS 2GHz PLL: Lock
- SBS 6GHz PLL: Lock
- Tx Type: TXX

Controls

- Enable Laser: On
- Laser Mode: Constant-Power
- AGC Mode: Off
- RF Drive Setting: 0.0 dB
- OMI Level Setting: 0.0 dB
- Master Master
- RFLasSet: Off
- Length: 110.0 km

Properties

- Devtype Revision: 1.00
- Name: S07
- Graphic
- Service Name
- Symbol
- Device Location
- M&C-Scan: On-Scan
- Maintenance Mode: Normal
- Poll Counter: 76
- Script
- Comm Alarm Threshold: 1
- Address: 7
- Port: COM1
- Generic Name: Transmitter
- Description: 1550 EMT Transmitter
- Software Revision: 6.13
- Script Version: 1431
- Serial Number: KKAAIKXX
- Time Of Service: 3 Hrs
- Day Code: DD9
- Module Type: 1040

2 Proceed with viewing the manufacturing data.

Note: For details on all manufacturing data parameters, see *Module Parameter Descriptions* (on page 105).

5

Maintenance and Troubleshooting

This chapter describes the maintenance guidelines and troubleshooting procedures for this module.

Qualified Personnel

Only appropriately qualified and trained personnel should attempt to maintain or troubleshoot these products.



WARNING:

Allow only qualified personnel to install, operate, maintain, or service this product. Otherwise, personal injury or equipment damage may occur.

In This Chapter

■ Maintenance	96
■ General Troubleshooting Information.....	97
■ Troubleshooting Alarm Conditions	98
■ Cleaning Optical Connectors	100

Maintenance

The following maintenance is recommended to ensure optimal performance.

Frequency	Maintenance Required
Yearly	<ul style="list-style-type: none"> ■ Check all parameters and test points. ■ Record data. ■ Make adjustments as needed. ■ Make sure all cables are mated properly. ■ Inspect cables for stress and chafing. ■ Make sure all retaining screws are tight. ■ Replace chassis air filter, if present. Depending on office environment cleanliness and filtration, the chassis air filter may require more frequent servicing.
When needed	Carefully clean the module with a soft cloth that is dampened with mild detergent.

Maintenance Record

It may be helpful to establish a maintenance record or log for this equipment. You may want to record laser power level, laser temperature readings, laser bias current, or power supply voltages, as well as the filter change dates.

Large variations in any of the parameters above should be investigated prior to failure.

General Troubleshooting Information

This troubleshooting information describes the most common alarms and gives typical symptoms, causes, and items to check before contacting Customer Service.

Equipment Needed

You may need the following equipment to troubleshoot these modules.

- Digital voltmeter
- Fiber connector cleaning materials

Additional Assistance

If you need additional assistance, telephone one of our Technical Service Centers or your local sales subsidiary. The chapter *Customer Information* (on page 103) contains a list of telephone numbers.

Troubleshooting

Refer to *Troubleshooting Alarm Conditions* (on page 98) to identify and correct faults.



WARNING:

Avoid electric shock and damage to this product! Do not open the enclosure of this product. There are no user-serviceable parts inside. Refer servicing to qualified and skilled personnel.

Troubleshooting Alarm Conditions

1550 nm EMT Transmitter (TXX, TXL) Alarm Conditions

If the red ALARM indicator is illuminated or is blinking, check the ICIM display or the appropriate LCI screen to determine the cause of the alarm.

Note: The Typical Range values shown below are based on unit testing and do not represent safe limits for units operating in the field. Actual values outside the typical range may be observed due to varying system configurations, and should not cause concern unless an alarm is also present.

Alarm	Typical Range	Possible Cause
Laser bias current	50 to 325 mA	Internal problem
Laser temperature	20 to 35°C	Check fan tray Change chassis air filter
Module temperature	-40 to 85°C	Check fan tray Change chassis air filter
Modulator bias	0.05 to 0.2 VDC	Internal problem
2 GHz SBS power	10 to 400	Internal problem
6 GHz SBS power	10 to 400	Internal problem
CP Lock	Lock or Unlock	Internal problem
RF input power	0 dB	Check RF source Check RF cable
Optical output power	±0.5 dB of nominal	Internal problem
-5 VDC supply voltage	-5 VDC high or low	Internal problem Check chassis power supply
-12 VDC supply voltage	-12 VDC high or low	Internal problem Check chassis power supply
+12 VDC supply voltage	+12 VDC high or low	Internal problem Check chassis power supply
Power supply status	Normal or Fault	Check module seating Check chassis power supply
Laser enabled status	Enable or Disable	Laser disabled
PLL Lock	Lock or Unlock	Internal problem

1550 nm Reverse Transmitter (TXR) Alarm Conditions

If the red ALARM indicator is illuminated or is blinking, check the ICIM display or the appropriate LCI screen to determine the cause of the alarm.

Note: The Typical Range values shown below are based on unit testing and do not represent safe limits for units operating in the field. Actual values outside the typical range may be observed due to varying system configurations, and should not cause concern unless an alarm is also present.

Alarm	Typical Range	Possible Cause
Laser bias current	50 to 325 mA	Internal problem
Laser temperature	20 to 35°C	Check fan tray Change chassis air filter
RF input power	0 dB	Check RF source Check RF cable
Optical output power	±0.5 dB of nominal	Internal problem
Power supply status	Normal or Fault	Check module seating Check chassis power supply
Laser enabled status	Enable or Disable	Laser disabled
CW mode status	Normal or Fault	CW mode ON

Cleaning Optical Connectors



CAUTION:

Proper operation of this equipment requires clean optical fibers. Dirty fibers will adversely affect performance. Proper cleaning is imperative.

The proper procedure for cleaning optical connectors depends on the connector type. The following describes general instructions for fiber optic cleaning. Use your company's established procedures, if any, but also consider the following.

Cleaning fiber optic connectors can help prevent interconnect problems and aid system performance. When optical connectors are disconnected or reconnected, the fiber surface can become dirty or scratched, reducing system performance.

Inspect connectors prior to mating, clean as needed, and then remove all residue. Inspect connectors after cleaning to confirm that they are clean and undamaged.

Recommended Equipment

- CLETOP or OPTIPOP ferrule cleaner (for specific connector type)
- Compressed air (also called “canned air”)
- Lint-free wipes moistened with optical-grade (99%) isopropyl alcohol
- Bulkhead swabs (for specific connector type)
- Optical connector scope with appropriate adaptor

Tips for Optimal Fiber Optic Connector Performance

- Do not connect or disconnect optical connectors with optical power present.
- Always use compressed air before cleaning the fiber optic connectors and when cleaning connector end caps.
- Always install or leave end caps on connectors when they are not in use.
- If you have any degraded signal problems, clean the fiber optic connector.
- Advance a clean portion of the ferrule cleaner reel for each cleaning.
- Turn off optical power before making or breaking optical connections to avoid microscopic damage to fiber mating surfaces.

To Clean Optical Connectors



Warning:

- **Avoid personal injury! Use of controls, adjustments, or procedures other than those specified herein may result in hazardous radiation exposure.**
- **Avoid personal injury! The laser light source on this equipment (if a transmitter) or the fiber cables connected to this equipment emit invisible laser radiation.**
- **Avoid personal injury! Viewing the laser output (if a transmitter) or fiber cable with optical instruments (such as eye loupes, magnifiers, or microscopes) may pose an eye hazard.**

- Do not apply power to this equipment if the fiber is unmated or unterminated.
- Do not stare into an unmated fiber or at any mirror-like surface that could reflect light emitted from an unterminated fiber.
- Use safety-approved optical fiber cable to maintain compliance with applicable laser safety requirements.

Important: Ensure that no optical power is present prior to this procedure.

- 1 Turn optical power off to the connector.
- 2 Using an optical connector scope, inspect the connector for scratches, burns, or other signs of damage.

Note: If the connector is damaged, replace the jumper.

- 3 If the connector requires cleaning, swipe it across the face of the appropriate ferrule cleaner several times. This will remove dust and some films.

Note: You may hear a slight "squeak" while cleaning the connector, indicating that it is clean.

- 4 Inspect the connector again. If the connector requires further cleaning, clean it using 99% isopropyl alcohol and a lint-free wipe.
- 5 Swipe the connector across the face of the appropriate ferrule cleaner several more times to remove any film left by the alcohol.
- 6 Repeat all the steps above as needed until the connector is clean.

6

Customer Information

If You Have Questions

If you have technical questions, call Cisco Services for assistance. Follow the menu options to speak with a service engineer.

Access your company's extranet site to view or order additional technical publications. For accessing instructions, contact the representative who handles your account. Check your extranet site often as the information is updated frequently.

A

Module Parameter Descriptions

Introduction

This appendix provides control, alarm, monitor, and manufacturing data parameters for this equipment.

In This Appendix

- 1550 nm EMT Transmitter Parameters 106
- 1550 nm Reverse Transmitter Parameters..... 110

1550 nm EMT Transmitter Parameters

The following tables describe the parameters for the P2-15TXL Long Reach and P2-15TXX Extended Reach transmitter modules.

Operating Status Parameters

Parameter Name (LCI)	ICIM Abbreviation	Function	Typical Value
Optical Output 1 Power	OutPwr1	Displays optical output power at port 1.	+10.0 dBm
Optical Output 2 Power (TXL)	OutPwr2 (TXL)	Displays optical output power at port 2.	+10.0 dBm
Laser Bias	LasBias	Displays measured laser bias current.	270 mA
RF Input	InRF	Displays RF input level.	0 dB
Module Temperature	ModTemp	Displays module temperature.	Ambient °C + 30°C
CP Lock	CPLock	Indicates constant power loop lock.	0.4
TEC Current	TecCur	Indicates laser thermoelectric cooler current.	0.2 A
Laser Temperature	LasTemp	Displays laser temperature.	30°C
Tx Type	TxType	Indicates Transmitter Extended Reach (TXX) or Long Reach (TXL).	TXX or TXL
Modulator Bias	ModBias	Indicates modulator bias voltage level.	0.128 VDC
SBS 2 GHz PLL	Sbs1Stat	SBS phase lock loop 1 lock status.	LOCK
SBS 6 GHz PLL	Sbs2Stat	SBS phase lock loop 2 lock status.	LOCK
SBS 2 GHz Power	Psbs2G	Indicates 2 GHz SBS power level.	90.5
SBS 6 GHz Power	Psbs6G	Indicates 6 GHz SBS power level.	120.0
-5V Supply Voltage	-5VInt	Displays internal -5 VDC supply voltage.	-5 VDC
-12V Supply Voltage	-12VInt	Displays internal -12 VDC supply voltage.	-12 VDC
+12V Supply Voltage	+12VInt	Displays internal +12 VDC supply voltage.	+12 VDC

Note: Monitored values may vary from module to module. The values shown above are examples only.

Configurable Parameters

Parameter Name (LCI)	ICIM Abbreviation	Description	Values	Default
Enable Laser	Enable	Enables or disables amplifier operation, i.e., turns the laser on or off.	ON (1) = Enabled OFF (0) = Disabled	ON (1)
Laser Mode	LasMode	Selects one of two laser operating modes: constant current (i.e., constant wavelength) or constant power.	Constant Current (ConstCur) Constant Power (ConstPwr)	ConstPwr
AGC Mode	AGC	Turns automatic gain control on or off.	ON (1) Off (0)	OFF (0)
RF Drive Setting	RFDrive	Sets the relative RF drive level into the transmitter. Only effective when AGC is off (manual gain control).	-6.0 dB to +1.0 dB in 0.5 dB steps	0.0 dB
OMI Level Setting	OMISet	Sets the optical modulation index level. Only effective when AGC is on. Note: When AGC is active, it maintains a constant OMI for input powers between -3 dB and +1 dB from nominal when OMI level is set to 0 dB. In general, guaranteed AGC range is (-3 + OMI Level) dB to +1 dB. For example, for an OMI level setting of +1 dB, the guaranteed AGC range is 2 dB to +1 dB. Actual AGC range is typically larger.	-6.0 dB to +1.0 dB in 0.5 dB steps	0.0 dB
Master	Master	Configures the module as master or slave: <ul style="list-style-type: none"> ■ If set to Master, the transmitter is controlled only by the Enable control above. ■ If set to Slave, the transmitter is controlled by a combination of Enable and the external input CNT_IN_1. 	ON (1) = Master OFF (0) = Slave	ON (1) = Master

Appendix A
Module Parameter Descriptions

Parameter Name (LCI)	ICIM Abbreviation	Description	Values	Default
RFLasSet	RFLasSet	Configures the transmitter to shut down the laser when an alarm threshold is met.	ON (1) OFF (0)	OFF (0)
Length	Length	Optimizes transmitter performance based on the distance or span of the link.	65 km to 105 km in 1 km steps (TXL) 100 km to 140 km in 1 km steps (TXX)	65 km (TXL) 100 km (TXX)

Alarm Data Parameters

Note: The Typical Range values shown below are based on unit testing and do not represent safe limits for units operating in the field. Actual values outside the typical range may be observed due to varying system configurations, and should not cause concern unless an alarm is also present.

Alarm Name (LCI)	ICIM Abbrev.	Alarm Condition	Typical Range	Possible Cause
Laser Bias *	LasBias *	Laser bias current	50 mA to 325 mA	Internal problem
Laser Temperature *	LasTemp *	Laser temperature	20°C to 35°C	Check fan tray
Module Temperature *	ModTemp *	Module temperature	-40°C to 85°C	Check fan tray
Modulator Bias	ModBias	Modulator bias	0.05 VDC to 0.2 VDC	Internal problem
SBS 2 GHz Power *	Psbs2G *	2 GHz SBS power level	10 to 400	Internal problem
SBS 6 GHz Power *	Psbs6G *	6 GHz SBS power level	10 to 400	Internal problem
CP Lock *	CPLock *	Constant power loop locked	Lock or Unlock	Internal problem
RF Input *	InRFdB *	RF input power	0 dB	Check RF source and cable
Optical Output 1 Power *	OutPwr *	Optical output power	±0.5 dB of nominal	Internal problem
-5V Supply Voltage *	-5VInt *	-5 VDC power supply	-5 VDC high or low	Internal problem
-12V Supply Voltage *	-12VInt *	-12 VDC power supply	-12 VDC high or low	Internal problem

Alarm Name (LCI)	ICIM Abbrev.	Alarm Condition	Typical Range	Possible Cause
+12V Supply Voltage *	+12VInt *	+12 VDC power supply	+12 VDC high or low	Internal problem
Power Supply Status	PsOk	Power supply status	Normal or Fault	Check module seating and chassis power supply
Laser Enabled Status	TxEnable	Laser on or off	Enable or Disable	Laser disabled
PL Lock	PLLock	Phase Loop Lock	Lock or Unlock	Internal problem

* These are user alarms whose limits can be changed by the user. All other alarms are module alarms whose limits are set at the factory and cannot be changed by the user.

Manufacturing Data Parameter Examples

Parameter Name (LCI)	ICIM Abbreviation	Typical Values
Generic Name	-	Transmitter
-	Module	1550 nm Optical Transmit
Description	-	1550 EMT Transmitter
Software Revision	Sw Ver	6.13
Script Version	Script Ver	1431
Serial Number	Serial #	Starts with MM or KK
Time of Service	In Service Hours	Positive integer value
-	Spec Data	Special data - for example: TXX 10 GHZ Lobch SA 4548
Day Code	Date Code	Alphanumeric value
Module Type	Module Type	1040
-	Restore Factory Defaults	Restores the module factory default configuration settings.

Note: All values shown above are examples only. Actual parameter values are dependent on module type and configuration.

1550 nm Reverse Transmitter Parameters

The following tables describe the parameters for the P2-15TXR Reverse QAM transmitter.

Operating Status Parameters

Parameter Name (LCI)	ICIM Abbreviation	Function	Typical Value
Laser Temperature	LasTemp	Displays laser temperature.	30°C
Laser Bias Current	LasBias	Displays measured laser bias current.	300 mA
RF Input Power	InRF	Displays relative RF input power level.	0 dB
Optical Output Power	OutPwr	Displays optical output power at port 1.	+8.0 dBm
Module Temperature	ModTemp	Displays module temperature.	Ambient °C + 28°C
TEC Current	TecCur	Indicates laser thermoelectric cooler current.	±50 mA

Note: Monitored values may vary from module to module. The values shown above are examples only.

Configurable Parameters

Parameter Name (LCI)	ICIM Abbreviation	Description	Values	Default
Enable Laser	Enable	Enables or disables amplifier operation, i.e., turns the laser on or off.	ON (1) = Enabled OFF (0) = Disabled	ON (1)
CW Mode	CWMode	Indicates Continuous Wave (CW) mode status.	ON (1) OFF (0)	OFF (0)
Low RF Alarm Inhibit	LoRFInh	Indicates low RF inhibit alarm status.	ON (1) OFF (0)	OFF (0)
Master	Master	Indicates Master or Slave operating status.	Master (1) Slave (0)	Master (1)

Parameter Name (LCI)	ICIM Abbreviation	Description	Values	Default
RF Drive Level	RFDrive	Sets the relative RF drive level into the transmitter. Only effective when AGC is off (manual gain control).	-1.5 dB to +1.5 dB in 0.5 dB steps	0.0 dB

Alarm Data Parameters

Note: The Typical Range values shown below are based on unit testing and do not represent safe limits for units operating in the field. Actual values outside the typical range may be observed due to varying system configurations, and should not cause concern unless an alarm is also present.

Alarm Name (LCI)	ICIM Abbrev.	Alarm Condition	Typical Range	Possible Cause
Laser Temperature *	LasTemp *	Laser temperature	20°C to 35°C	Check fan tray
Laser Bias Current *	LasBias *	Laser bias current	50 mA to 100 mA	Internal problem
RF Input *	InRF *	RF input power	0 dB	Check RF source and cable
Optical Output Power *	OutPwr *	Optical output power	±0.5 dB of nominal	Internal problem
Laser Enabled Status	TxEnable	Laser on or off	Enable or Disable	Laser disabled
CW Mode Status	CW Mode Status	Continuous Wave mode status	ON or OFF	CW mode disabled
Power Supply Status	PsOk	Power supply status	Normal or Fault	Check module seating and chassis power supply

* These are user alarms whose limits can be changed by the user. All other alarms are module alarms whose limits are set at the factory and cannot be changed by the user.

Manufacturing Data Parameter Examples

Parameter Name (LCI)	ICIM Abbreviation	Typical Values
-	Module	15xx Reverse QAM
Description	-	1550nm Reverse Transmitter
Software Revision	Sw Ver	1.xx
Script Version	Script Ver	1.xx
Serial Number	Serial #	Starts with MM or KK
Time of Service	In Service Hours	Positive integer value
-	Spec Data	Special information; may be blank
Day Code	Date Code	Alphanumeric value
Module Type	Module Type	1012
-	Restore Factory Defaults	Restores the module factory default configuration settings.

Note: All values shown above are examples only. Actual parameter values are dependent on module type and configuration.

Glossary

ac, AC

alternating current. An electric current that reverses its direction at regularly recurring intervals.

AGC

automatic gain control. A process or means by which gain is automatically adjusted in a specified manner as a function of input level or other specified parameters.

CAN

cancel. The cancel character.

CP

constant (optical) power.

dc, DC

direct current. An electric current flowing in one direction only and substantially constant in value.

DFB laser

distributed feedback laser. An injection laser diode that has a Bragg reflection grating in the active region in order to suppress multiple longitudinal modes and enhance a single longitudinal mode.

EDFA

erbium doped fiber amplifier. Optical fibers doped with the rare earth element, erbium, which can amplify light in the 1550 nm region when pumped by an external light source.

EIA

Electronic Industries Association. A United States association that provides standards for use between manufacturers and purchasers of electronic products.

EMC

electromagnetic compatibility. A measure of equipment tolerance to external electromagnetic

Glossary

fields.

EMT

externally-modulated transmitter.

ESD

electrostatic discharge. Discharge of stored static electricity that can damage electronic equipment and impair electrical circuitry, resulting in complete or intermittent failures.

FHEDA

forward headend driver amplifier.

HD

high density.

HEDA

headend driver amplifier.

I/O

input/output.

ICIM

intelligent communications interface module.

IP

Internet protocol. A standard that was originally developed by the United States Department of Defense to support the internetworking of dissimilar computers across a network. IP is perhaps the most important of the protocols on which the Internet is based. It is the standard that describes software that keeps track of the internetwork addresses for different nodes, routes, and outgoing/incoming messages on a network. Some examples of IP applications include email, chat, and Web browsers.

LCD

liquid crystal display. A display medium made of liquid crystal. Liquid crystal's reflectance changes when an electric field is applied. Commonly used in monitors, televisions, cell phones, digital watches, etc.

LCI

local craft interface.

LED

light-emitting diode. An electronic device that lights up when electricity passes through it.

MIB

management information base. SNMP collects management information from devices on the network and records the information in a management information base. The MIB information includes device features, data throughput statistics, traffic overloads, and errors.

nm

nanometer. One billionth of a meter.

NMS

network management system. A software system designed specifically to monitor a network and to facilitate troubleshooting.

OMI

optical modulation index, expressed in decimal or percentage notation.

PLL

phase lock loop. An electronic servo system controlling an oscillator to maintain a constant phase angle relative to a reference signal.

QAM

quadrature amplitude modulation. An amplitude and phase modulation technique for representing digital information and transmitting that data with minimal bandwidth. Both phase and amplitude of carrier waves are altered to represent the binary code. By manipulating two factors, more discrete digital states are possible and therefore larger binary schemes can be represented.

RF

radio frequency. The frequency in the portion of the electromagnetic spectrum that is above the audio frequencies and below the infrared frequencies, used in radio transmission systems.

RMA

return material authorization. A form used to return products.

RT

remote terminal. Remote equipment of a supervisory system.

Glossary

RX

receive or receiver.

SBS

stimulated Brillouin scattering. The easiest fiber nonlinearity to trigger. When a powerful lightwave travels through a fiber, it interacts with acoustical vibration modes in the glass. This causes a scattering mechanism to be formed that reflects some of the light back to the source.

SMC

status monitoring and control. The process by which the operation, configuration, and performance of individual elements in a network or system are monitored and controlled from a central location.

SNMP

simple network management protocol. A protocol that governs network management and the monitoring of network devices and their functions.

TEC

thermoelectric cooler. A device used to dissipate heat in electronic assemblies.

TNCS

Transmission Network Control System. A Cisco application that allows status monitoring and control of all transmission equipment located in headends and hubs plus optical nodes, power supplies, and amplifiers in the outside plant. TNCS provides access to and information on the entire network in an easy to understand, topology driven, graphical user display.

torque

A force that produces rotation or torsion. Usually expressed in lb-ft (pound-feet) or N-m (Newton-meters). The application of one pound of force on a lever at a point on the lever that is one foot from the pivot point would produce 1 lb-ft of torque.

TX

transmit or transmitter.

Index

1

- 1550 nm EMT Transmitter (TXX, TXL) Alarm Conditions • 98
- 1550 nm EMT Transmitter Parameters • 106
- 1550 nm Reverse Transmitter (TXR) Alarm Conditions • 99
- 1550 nm Reverse Transmitter Parameters • 110

A

- ac, AC • 113
- Access Requirements • 13
- Accessing Module Details • 78
- Additional Assistance • 97
- Adjusting Alarm Thresholds • 66
- AGC • 113
- Alarm Data Parameters • 108, 111
- Alarm Threshold Menus • 52
- ALARMS IN and ALARMS OUT Connections • 28
- ALARMS IN and ALARMS OUT Connector Illustration • 29

B

- Back Panel Connectors • 8
- Back Panel Illustration • 8
- Basic SNMP Setup • 56
- Boot Dialog for ICIM/SNMP Configuration • 63

C

- Cable Requirements • 69
- CAN • 113
- Chassis Style • 14
- Checking Alarms using the ICIM • 50
- Checking Manufacturing Data using LCI • 93
- Checking Manufacturing Data using the ICIM • 53
- Checking the Module Alarms using LCI • 89
- Checking the Operating Status • 85
- Checking the Operating Status using the ICIM • 46
- Cleaning Optical Connectors • 21, 100

- Community Strings • 59
- Computer Requirements • 69
- CONFIG Menus • 49
- Configurable Parameters • 107, 110
- Configuration and Monitoring Methods • 9
- Configuration Complete • 55
- Configuration Overview • 9
- Configuration Summary • 10
- Configuring the Module using LCI • 87
- Configuring the Module using the ICIM • 48
- Connecting Optical Cables • 23
- Connecting the Chassis to the TNCS Server • 26
- Connecting the ICIM to Additional Chassis • 24
- Connecting the RF Cables to the Chassis • 16
- Connecting Your Computer to the Chassis • 74
- CP • 113
- Customer Information • 103

D

- dc, DC • 113
- Default Community Strings • 59
- Description • 3
- DFB laser • 113

E

- EDFA • 113
- EIA • 113
- EMC • 113
- EMT • 114
- EMT Block Diagram • 5
- EMT Illustration • 6
- Equipment and Tools Needed • 12
- Equipment Needed • 97
- Equipment Rack • 13
- ESD • 114
- Expired Password or Inactive Password Messages • 37

F

- Features • 3
- FHEDA • 114
- Fiber Fish Tool • 19

Front Access Chassis Illustration • 15

G

General Troubleshooting Information • 97

H

HD • 114

HEDA • 114

I

I/O • 114

ICIM • 114

ICIM Block Diagram • 32

ICIM Front Panel Features • 34

ICIM Front Panel Illustration • 33

ICIM IN and ICIM OUT Cables • 24

ICIM IN and ICIM OUT Connectors • 24

ICIM Introduction • 32

ICIM Keypad • 35

ICIM Password • 36

ICIM2 LCD • 34

Installation • 11

Installing LCI • 70

Installing the Module in the Chassis • 17

Introduction • 1

IP • 114

L

Laser Warning • 68

LCD • 114

LCI • 114

LCI Function • 68

LCI Introduction • 68

LCI Module Tree • 77

LED • 115

M

MAIN and ICIM Menu Structures • 43

Maintenance • 96

Maintenance and Troubleshooting • 95

Maintenance Record • 96

Making External Alarm Connections • 28

Manufacturing Data Parameter Examples • 109,
112

Master/Slave Illustration • 29

MFG. DATA Menus • 54

MIB • 115

Modifying Module Alarm Limits using LCI • 91

Module Details Window • 78

Module Tree Levels • 77

N

New SNMP Variables • 61

nm • 115

NMS • 115

O

OMI • 115

Operating Environment • 13

Operating Status Parameters • 106, 110

Operation • 4

Operation Using LCI • 67

Operation Using the ICIM • 31

Optical Output • 4

P

Password Protection System • 36

PLL • 115

Power Requirements • 14

Preparing for Installation • 12

Previous IP Address • 62

Prisma II 1550 nm Full Height Reverse QAM
(TXR) Transmitter Software Menu Structure •
45

Prisma II 1550 nm Long Reach and Extended
Reach EMT (TXL,TXX) Software Menu
Structure • 44

Prisma II Redundancy Interface Panel
Illustrations • 30

Q

QAM • 115

QAM Transmitter Block Diagram • 5

QAM Transmitter Illustration • 7

R

Rear Access Chassis Illustration • 14

Recommended Equipment • 21, 100

Redundancy Interface Panel • 29

RF • 115

RMA • 115

Routing Optical Cables • 19

RT • 115

RX • 116

S

Saving the Configuration using the ICIM • 55

SBS • 116

Setting SNMP Trap Receiver Parameters • 60

Site Requirements • 13

SMC • 116
 SNMP • 116
 SNMP Configuration • 56
 SNMP Considerations • 56
 Space Requirements • 14
 Starting LCI Software • 75
 STATUS Menus • 47
 System Requirements • 69

T

Table of Inserted Modules • 61
 Table of Removed Modules • 61
 TEC • 116
 The Back Panel • 8
 The Fiber Fish Tool Hook • 19
 The Front Panel • 6
 The ICIM Front Panel • 33
 Tips for Optimal Fiber Optic Connector
 Performance • 21, 100
 TNCS • 116
 To Access the ICIM Menu • 42
 To Access the MAIN Menu • 41
 To Access the Module Details, Double-Click the
 Chassis • 80
 To Access the Module Details, Double-Click the
 Module • 83
 To Access the Module Details, Right-Click the
 Chassis • 81
 To Access the Module Details, Right-Click the
 Module • 84
 To Access the Password Menu • 37
 To Adjust Alarm Thresholds • 66
 To Adjust the LCD Contrast • 41
 To Change Parameters • 65
 To Change the User Password • 39
 To Check Alarm Thresholds • 52
 To Check Alarms using LCI • 89
 To Check Alarms using the ICIM • 50
 To Check Manufacturing Data • 53
 To Check Manufacturing Data using LCI • 93
 To Check Operating Status using the ICIM • 46
 To Check the Operating Status using LCI • 85
 To Clean Optical Connectors • 22, 101
 To Configure Parameters using LCI • 87
 To Configure Parameters using the ICIM • 48
 To Connect a Computer to the Chassis • 74
 To Connect Chassis-to-Chassis ICIM IN and
 ICIM OUT Ports • 25
 To Connect Optical Cables • 23
 To Connect RF Cables • 16

To Connect TNCS to the Chassis EM IN Port •
 26
 To Disable the User Password using ICIM • 40
 To Enter the User Password • 38
 To Install the LCI Software • 70
 To Install the Module • 17
 To Modify Alarm Limits using LCI • 91
 To Prepare to Change Parameters • 64
 To Pull the Optical Cable to the Module • 20
 To Restart the ICIM by Removing the ICIM • 58
 To Restart the ICIM using ICIM • 65
 To Save the Current Configuration • 55
 To Set Adjustable Alarm Thresholds using the
 ICIM • 51
 To Set Traps for a Specific IP Address using
 P2TrapRecvEntry • 60
 To Set Up the IP Configuration Parameters for
 SNMP Support using ICIM • 57
 To Start LCI Software • 75
 To View Alarms • 51
 torque • 116
 Troubleshooting • 97
 Troubleshooting Alarm Conditions • 98
 TX • 116

U

Unpacking and Inspecting the Module • 12
 Using the ICIM • 41
 Using TNCS with Multiple Chassis • 27



Cisco Systems, Inc.
5030 Sugarloaf Parkway, Box 465447
Lawrenceville, GA 30042

678 277-1120
800 722-2009
www.cisco.com

This document includes various trademarks of Cisco Systems, Inc. Please see the Notices section of this document for a list of the Cisco Systems, Inc. trademarks used in this document.

Product and service availability are subject to change without notice.

© 2001, 2004, 2008-2009, 2012 Cisco and/or its affiliates.

All rights reserved.

October 2012 Printed in USA

Part Number 78-739259-01 Rev G