



# **Prisma II Forward and Reverse Headend Driver Amplifiers**

Installation and Operation Guide

# For Your Safety







---

## Explanation of Warning and Caution Icons



**Avoid personal injury and product damage! Do not proceed beyond any symbol until you fully understand the indicated conditions.**

The following warning and caution icons alert you to important information about the safe operation of this product:

-  **You may find this symbol in the document that accompanies this product. This symbol indicates important operating or maintenance instructions.**
-  **You may find this symbol affixed to the product. This symbol indicates a live terminal where a dangerous voltage may be present; the tip of the flash points to the terminal device.**
-  **You may find this symbol affixed to the product. This symbol indicates a protective ground terminal.**
-  **You may find this symbol affixed to the product. This symbol indicates a chassis terminal (normally used for equipotential bonding).**
-  **You may find this symbol affixed to the product. This symbol warns of a potentially hot surface.**
-  **You may find this symbol affixed to the product and in this document. This symbol indicates an infrared laser that transmits intensity-modulated light and emits invisible laser radiation or an LED that transmits intensity-modulated light.**

## Important

Please read this entire guide. If this guide provides installation or operation instructions, give particular attention to all safety statements included in this guide.

# Notices

---

## Trademark Acknowledgments

Cisco and the Cisco logo are trademarks or registered trademarks of Cisco and/or its affiliates in the U.S. and other countries. To view a list of cisco trademarks, go to this URL: [www.cisco.com/go/trademarks](http://www.cisco.com/go/trademarks).

Third party trademarks mentioned are the property of their respective owners.

The use of the word partner does not imply a partnership relationship between Cisco and any other company. (1110R)

## Publication Disclaimer

Cisco Systems, Inc. assumes no responsibility for errors or omissions that may appear in this publication. We reserve the right to change this publication at any time without notice. This document is not to be construed as conferring by implication, estoppel, or otherwise any license or right under any copyright or patent, whether or not the use of any information in this document employs an invention claimed in any existing or later issued patent.

## Copyright

© 2008, 2012 Cisco and/or its affiliates. All rights reserved. Printed in the United States of America.

Information in this publication is subject to change without notice. No part of this publication may be reproduced or transmitted in any form, by photocopy, microfilm, xerography, or any other means, or incorporated into any information retrieval system, electronic or mechanical, for any purpose, without the express permission of Cisco Systems, Inc.

# Contents

---

Safety Precautions .....	v
Compliance .....	vi
<b>Chapter 1</b>	<b>Introduction</b>
Overview .....	1-1
HEDA Description .....	1-2
The HEDA Front Panel.....	1-5
The HEDA Rear Panel .....	1-7
<b>Chapter 2</b>	<b>Installation</b>
Overview .....	2-1
Preparing for Installation .....	2-2
Site Requirements.....	2-3
Connecting the RF Cables to the Chassis.....	2-6
Installing the Module in the Chassis .....	2-7
<b>Chapter 3</b>	<b>Operation</b>
Overview .....	3-1
Operating the HEDA .....	3-2
Ensuring Proper Signal Strength and Adjusting the Selectable Pad.....	3-4
Ensuring a Flat Output Signal by Adjusting the Step Equalizer .....	3-5
Checking the Operating Settings.....	3-7

# Contents, Continued

---

<b>Chapter 4</b>	<b>Maintenance and Troubleshooting</b>	
	Overview .....	4-1
	HEDA Maintenance .....	4-2
	General Troubleshooting Information .....	4-3
	Troubleshooting Alarm Conditions.....	4-4
	Power Supply Related Alarms .....	4-5
<b>Chapter 5</b>	<b>Customer Information</b>	
<b>Glossary</b> .....		Glossary -1

# Safety Precautions

---

## Protect Yourself From Electric Shock and Your System From Damage!

- This product complies with international safety and design standards. Observe all safety procedures that appear throughout this guide, and the safety symbols that are affixed to this product.
- If circumstances impair the safe operation of this product, stop operation and secure this product against further operation.

## Safety Symbols

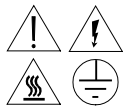

**Avoid personal injury and product damage! Do not proceed beyond any symbol until you fully understand the indicated conditions!**



**You will find this symbol in the literature that accompanies this product. This symbol indicates important operating or maintenance instructions.**



**You may find this symbol affixed to this product. This symbol indicates a live terminal; the flash points to the terminal device.**



**You may find this symbol affixed to this product. This symbol indicates a protective earth terminal.**



**You may find this symbol affixed to this product. This symbol indicates excessive or dangerous heat.**

## Enclosure

- Do not allow moisture to enter this product.
- Do not open the enclosure of this product unless otherwise specified.
- Do not push objects through openings in the enclosure of this product.

## Cables

- Always pull on the plug or the connector to disconnect a cable. Never pull on the cable itself.

## Factory Service

Refer service only to service personnel who are authorized by the factory.

# Compliance

---

## Electrical Safety

**CSA C22.2 No. 1:1994:** A sample of this equipment has been tested and found to meet the requirements of CSA C22.2 No. 1:1994.

## Electromagnetic Compatibility



### **CAUTION:**

**Any changes or modification to this equipment not expressly approved by Cisco can void the user's authority to operate this equipment.**

**FCC Part 15 Subpart B:** This equipment has been tested and found to comply with the limits for a Class A digital device according to Part 15 of FCC Rules. These limits are designed to provide reasonable protection against harmful interference when the equipment is operated in a commercial environment.

This equipment generates, uses, and can radiate radio frequency energy and, if not installed and used in accordance with the instruction manual, may cause harmful interference to radio communications. Operation of this equipment in a residential area is likely to cause harmful interference in which case the user will be required to correct the interference at his own expense.

# Chapter 1

## Introduction

### Overview

---

#### Introduction

This chapter presents a general introduction to both the Prisma® II Forward Headend Driver Amplifiers and Prisma II Reverse Headend Driver Amplifiers (HEDA). Descriptions of the front and rear panels are included with block diagrams.

The Prisma II Forward Headend Driver Amplifier and the Prisma II Reverse Headend Driver Amplifier are separate modules with different part numbers. However, with the exception of their application and a few important signal adjustments, they are installed and function in almost exactly the same manner. Therefore, except in the few places where their operation differs, the two HEDA modules are referred to as one module for the purposes of this guide.

#### Qualified Personnel

Only appropriately qualified and trained personnel should attempt to install this product.



**WARNING:**

**Allow only qualified personnel to install, operate, maintain, and service this product. Otherwise, personal injury or equipment damage may occur.**

#### In This Chapter

This chapter contains the following topics.

Topic	See Page
HEDA Description	1-2
The HEDA Front Panel	1-5
The HEDA Rear Panel	1-7



# HEDA Description

---

## Overview

The Prisma II Forward and Reverse Headend Driver Amplifiers are two of a family of products in the Prisma II product line.

Both the Prisma II Forward and Reverse Headend Driver Amplifier modules are designed to boost the RF signal level to meet the input requirements of headend/hub equipment including the Prisma optical transmitters. The forward unit is used in forward frequency (46–870 MHz) transmissions. The reverse unit is used in reverse frequency (5–200 MHz) transmissions and in the reverse combining process to amplify the return path signals to meet the input requirements of the service devices.

## The Headend Driver Amplifier as Part of the Prisma Platform

Both the Forward and Reverse Headend Driver Amplifiers are single-width modules. Once installed in a Prisma II Chassis, they communicate with the chassis only for electrical power and operational signal amplification.

**Important:** While the Prisma II Forward and Reverse Headend Driver Amplifiers are installed and operate in conjunction with other modules in the Prisma II Chassis, they do not report status or alarm information to the ICIM, LCI, or TNCS software. **All HEDA alarm indications and operating adjustments are performed at the front panel of the HEDA module.**

## HEDA Features

The Prisma II Headend Driver Amplifiers have the following features.

- Front panel green LED to indicate operating status
- Front panel red LED to indicate alarm status
- -20 dB test point
- PIN attenuator adjustment
- Selectable Equalizer adjustment
- Plug-and-play capability
- Blind mate RF connections

## HEDA Description, Continued

---

### HEDA Function

The Prisma II HEDA is designed for indoor applications, such as headend, hub, remote terminal, and central office environments. The Prisma II HEDA may be used to boost either broadcast or new media signals to meet the requirements of the Prisma II optical transmitters or other devices.

The Prisma II HEDA has a selectable pad settings and a selectable equalizer steps to control the RF input level and correct for cable tilt. These adjustments are both made on the front panel of the module. The HEDA also provides a contact closure, back through to the chassis ALARM OUT connector, for external alarm purposes.

### Headend Driver Amplifier Theory of Operation

A modulated signal is input to the Headend Driver Amplifier at the rear panel RF input connector "A". A -20 dB test point is available for checking the RF input level. The RF input signal is sent through a pin attenuator. The pin attenuator has 3 dB of range, from 0.0 dB to 3.0 dB in 1 dB steps. Stepping this control labeled **PAD** on the front panel with a small flat head screwdriver will adjust the pin attenuator.

The RF signal is then sent to the selectable equalizer. By adjusting the selectable equalizer you may compensate for cable roll off or roll off from a previous module. This control is labeled **TILT** on the front panel.

Next, the signal is amplified and sent to the RF output connector on the rear panel.

# HEDA Description, Continued

## Forward HEDA Block Diagram

A block diagram of the Prisma II Forward Headend Driver Amplifier is shown below.

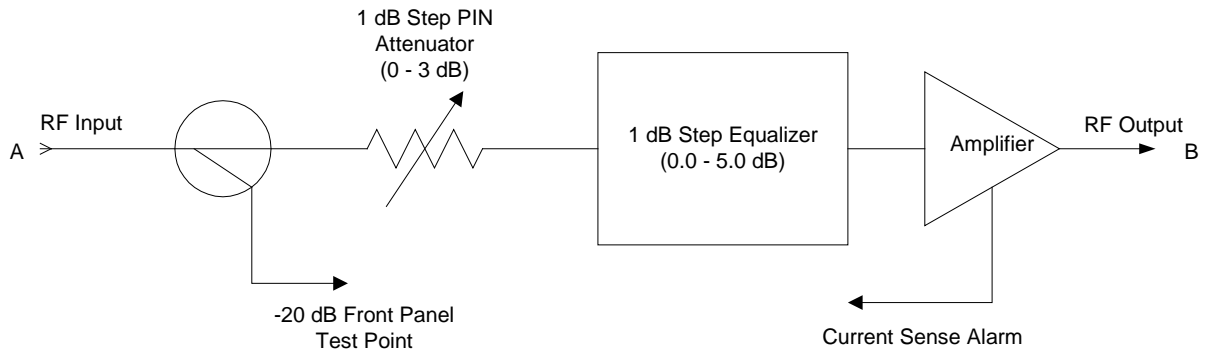

## Reverse HEDA Block Diagram

A block diagram of the Prisma II Reverse Headend Driver Amplifier is shown below.

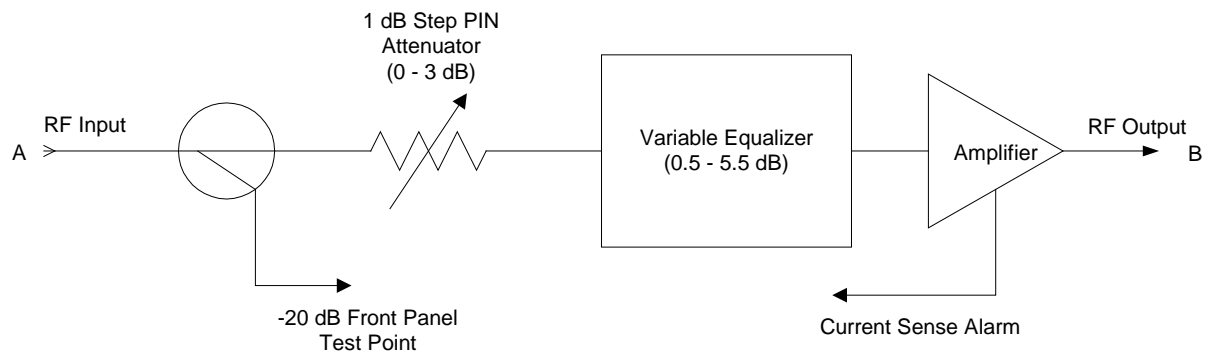

# The HEDA Front Panel

## Front Panel Description

The front panel of both the Forward and the Reverse Headend Driver Amplifiers are designed for easy adjustment and quick monitoring. The HEDA front panel has the following easily accessible features.

- PIN Attenuator
- Selectable Equalizer
- Alarm Indicator (red)
- Power ON Indicator (green)
- -20 dB Input Test Point

With identical indicators, adjusters, and test points on the front panel, you can quickly install and balance both the forward and reverse amplifiers.

Prisma II Forward HEDA

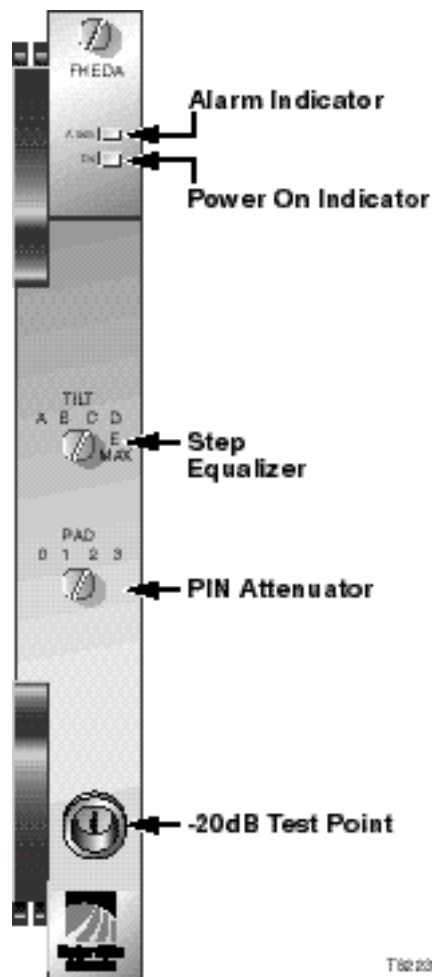

Prisma II Reverse HEDA

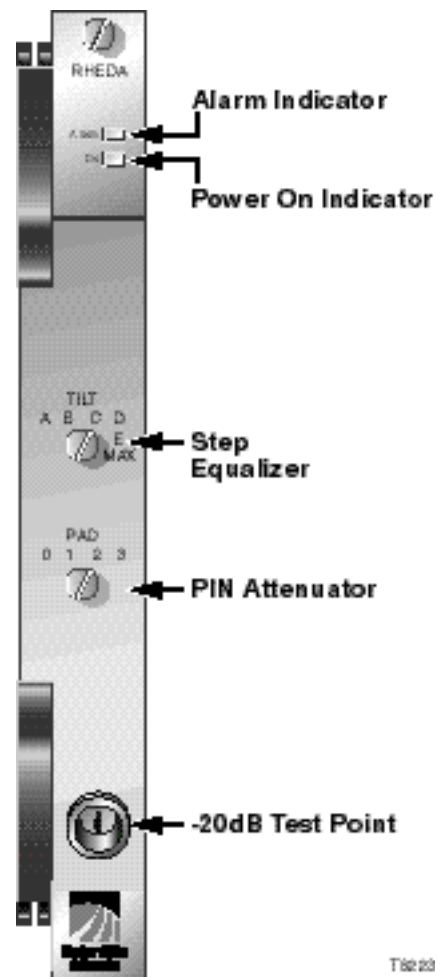

## The HEDA Front Panel, Continued

---

### Power and Alarm Indicators

Two indicators give you the status of the HEDA.

- The green POWER ON indicator turns on and stays on as long as power is applied to the HEDA.
- The red ALARM indicator blinks when either of the following conditions occurs.
  - High current draw through the HEDA
  - Low current draw through the HEDA
- The red ALARM indicator illuminates continuously when there is a loss of RF signal or loss of current through the HEDA.

### Pad and Equalizer Adjustment

You can quickly balance the HEDA by inserting a 1/8-in. flatblade screwdriver into the open slots labeled **PAD** and **TILT**. Two recessed adjusters just inside the front panel allow adjustment of the pad and tilt settings to values shown in the following tables.

Pad Setting	Loss Introduced
0	0 dB
1	1 dB
2	2 dB
3	3 dB

Tilt Setting	Amount of Signal Equalization	
	Forward Model (46-870 MHz)	Reverse Model (5-200 MHz)
A	0.0 dB	0.5 dB
B	1.0 dB	1.5 dB
C	2.0 dB	2.5 dB
D	3.0 dB	3.5 dB
E	4.0 dB	4.5 dB
MAX	5.0 dB	5.5 dB

### -20 dB Test Point

The connector labeled "1" provides a sample of the RF drive signal going directly into the amplifier. Since this signal feeds off a -20 dB RF directional coupler in line with the amplifier, you must add 20 dB to the reading you get at this test point to determine the actual RF input level.

# The HEDA Rear Panel

---

## HEDA Rear Panel Connectors

Blind-mate connectors make it easy to install this module. The connector on the back of the module mates with a like connector on the inside of the chassis. The 110-pin connector provides the electrical power connection to the module

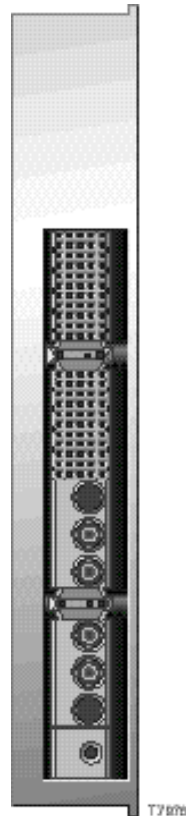

## Power and Communications Connector

The 110-pin power and communications connector on the back of the HEDA mates with corresponding connectors inside of the Prisma II Chassis and supplies power from the chassis to the HEDA.

# Chapter 2

## Installation

### Overview

---

#### Introduction

This chapter contains instructions, site requirements, equipment, and tools needed to install the Prisma II Headend Driver Amplifiers (HEDA).

The Prisma II Forward Headend Driver Amplifier and the Prisma II Reverse Headend Driver Amplifier are separate modules with different part numbers. However, with the exception of their application and a few important signal adjustments, they are installed and function in almost exactly the same manner and are referred to as one module for the purposes of this guide.

#### Qualified Personnel



**WARNING:**

**Allow only qualified personnel to install, operate, maintain, or service this product. Otherwise, personal injury or equipment damage may occur.**

#### In This Chapter

This chapter gives step-by-step instructions on installing the Prisma II HEDA.

Topic	See Page
Preparing for Installation	2-2
Site Requirements	2-3
Connecting the RF Cables to the Chassis	2-6
Installing the Module in the Chassis	2-7

# Preparing for Installation

---

## Overview

Before you begin, make sure that the module is in good condition and that you have the tools and equipment listed here.

## Unpacking and Inspecting the Module

As you unpack the module, inspect it for shipping damage. If you find any damage, contact Cisco Services.

## Equipment and Tools Needed

Before you begin, make sure that the module is in good condition. You need the following equipment and tools to install these modules.

<b>You need . . .</b>	<b>To . . .</b>
a Prisma II Chassis with power supply	provide housing, power and input/output connections to the HEDA.
3/8-in. flat-blade screwdriver	secure the HEDA in the chassis.
1/8-in. flat blade screwdriver	make <b>PAD</b> and <b>TILT</b> adjustments
two RF cables with connectors	carry RF input and output signals.



# Site Requirements

---

## Overview

Before you begin, make certain that your installation site meets the requirements discussed in this section.

## Access Requirements

Ensure that only authorized personnel have access to this equipment. Otherwise, personal injury or equipment damage may occur.

 **WARNING:**  
**Use this product in locations that restrict access to all persons who are not authorized. Otherwise, personal injury or equipment damage may occur.**

## Equipment Rack

To install the modules, your site should be equipped with an Electronics Industry Association (EIA) equipment rack that will properly house the Prisma II chassis with proper spacing for air circulation. For instructions on installing the chassis in the rack, refer to the guide that was shipped with the chassis.

## Operating Environment

 **CAUTION:**  
**Avoid damage to this product! Operating this product above the maximum operating temperature specified voids the warranty.**

Follow these recommendations to maintain an acceptable operating temperature.

- Chassis air inlet temperature must be between -40°C and 65°C (-40°F and 149 °F)
- Keep cooling vents clear and free of obstructions.
- Provide ventilation, as needed, using one or more of the following methods.
  - air-deflecting baffles
  - forced-air ventilation
  - air outlets above enclosures

## Site Requirements, Continued

---

### Power Requirements

The Prisma II HEDA receives its electrical power from the Prisma II Chassis. The module may be installed with the chassis powered-up.

### Space Requirements

The Prisma II Headend Driver Amplifier is a single-width module. It is usually installed in slots five through sixteen. Slots one through four are usually reserved for the power supplies. Slots fifteen and sixteen may or may not be used with the Intelligent Communications Interface Module (ICIM).

If an ICIM is not installed, any other module could be installed in these slots. Slot 2 and slot 4 are reserved for an internal power supply if installed. If an internal power supply is not installed here, any other module could be installed in these slots.

### Chassis Style

The Prisma II Chassis may be ordered as front access or rear access depending on the system you have purchased. Power inlets, RF inputs, RF outputs, and other connectors may be located on either the front or rear of the Prisma II Chassis. Connections to the chassis serve the same purpose and are made in the same manner regardless of the location of the connectors or chassis configuration.

# Site Requirements, Continued

## Rear Access Chassis

The Prisma II Chassis may be configured with front or rear connectors depending on the system you have purchased. The rear access chassis is shown here.

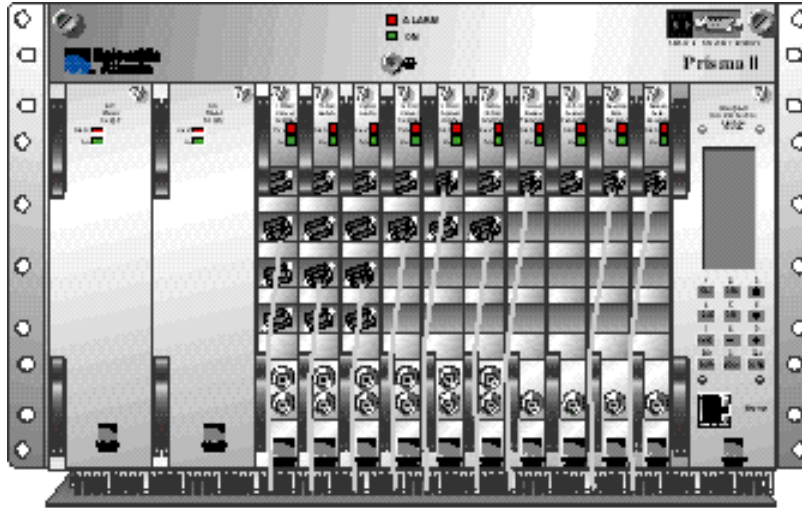

T8036

## Front Access Chassis illustration

The front access chassis is shown here.

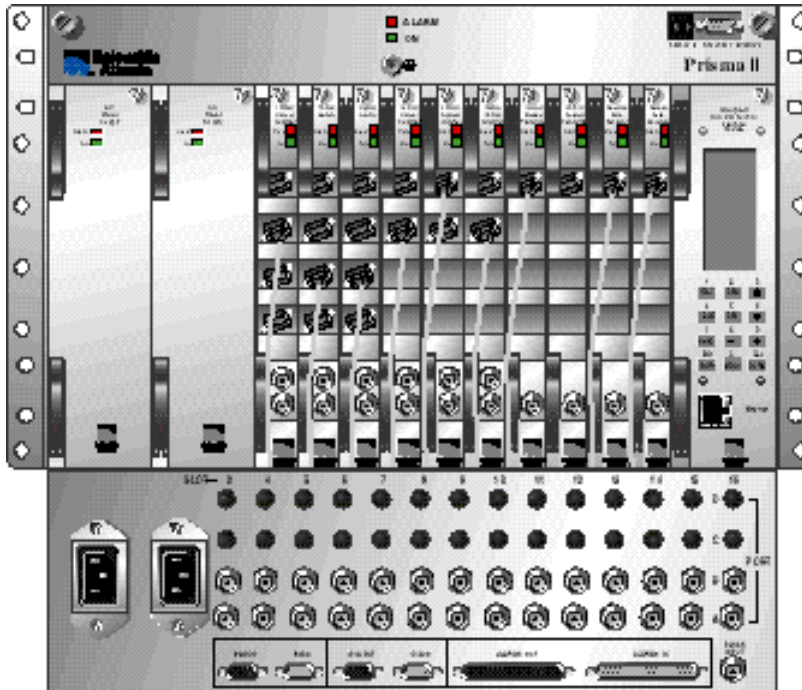

T8036

# Connecting the RF Cables to the Chassis

## RF Cable Connection Procedure

**Important:** The following procedure assumes the Prisma II Chassis is mounted in a rack.

Follow this procedure to make the RF cable connections for each HEDA to be installed. The HEDA is usually installed in slots five through sixteen.

1. Locate one 75 ohm RF cable and connect it to the appropriate RF source.
2. At the rear of the Prisma II Chassis, attach the other end of the RF source cable to Port A (RF Input) of the slot where the HEDA is to be installed. This is the RF input connection.

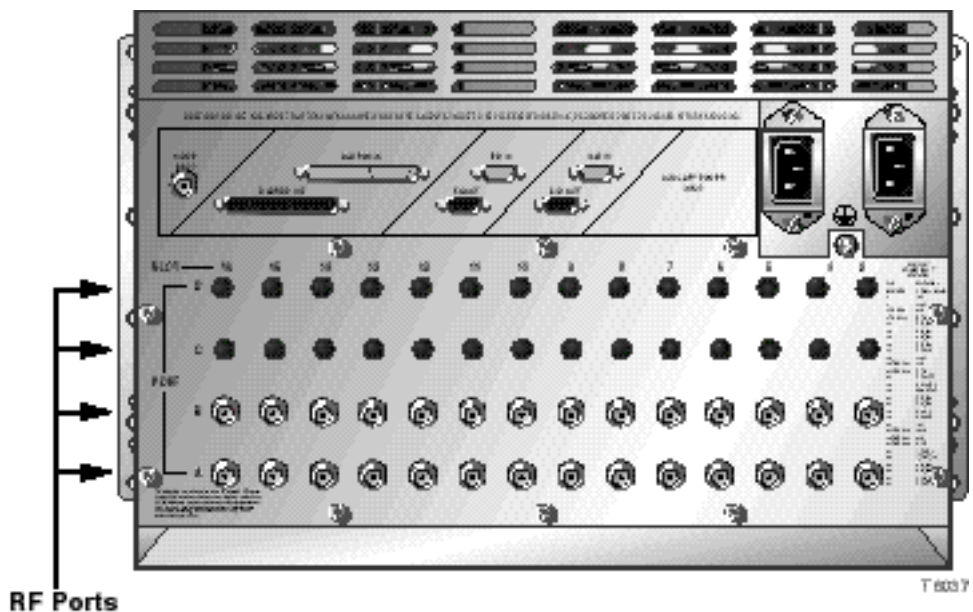

3. Connect another RF cable from Port B (RF Output) of the slot where the HEDA is to be installed. Hand-tighten the connector.

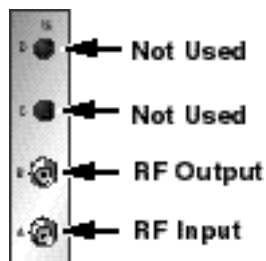

4. Route the RF cable from Port B (RF Output) to the appropriate destination.
5. If F-connectors are installed, use a 7/16-in. open-end wrench to secure both cables to the threaded F-connectors at the chassis.

# Installing the Module in the Chassis

---

## Installing the HEDA Module

**Important:** The following procedure assumes the chassis is mounted in a rack.

To install the HEDA module in the chassis, follow these steps.

1. Locate the module guide slots inside the chassis as shown in the following illustration.

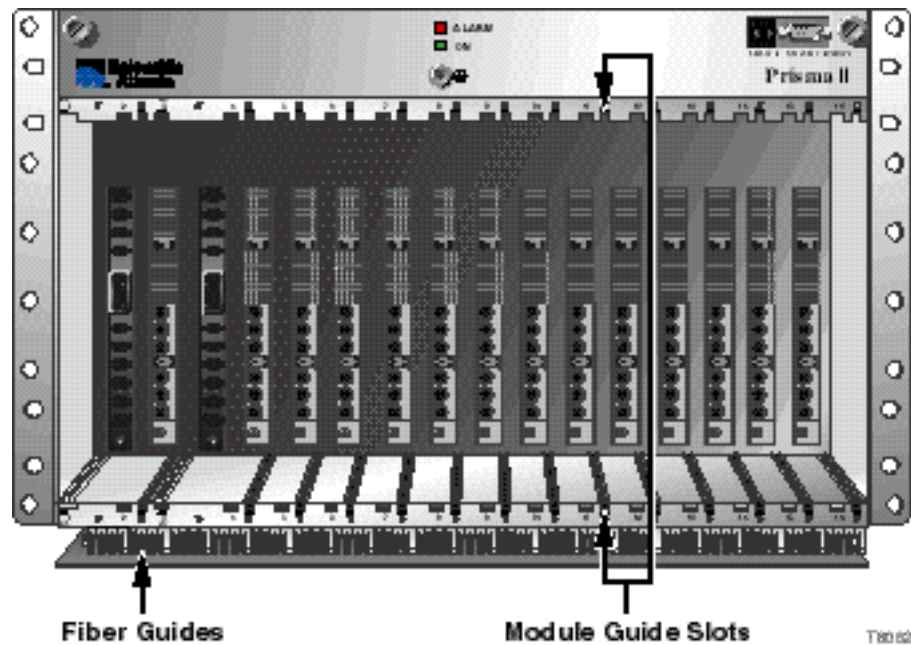

2. Align the ridges on the top and bottom of the HEDA with the module guide slots located on the chassis.

## Installing the Module in the Chassis, Continued

---

3. Gently slide the module into the chassis until you feel the connectors on the back of the module join the receptacles at the back of the slot. Use the module ejector to lock the module in place.

**Note:** Do not force or bang the module into the chassis. If properly aligned, it should slide in with minimal force.

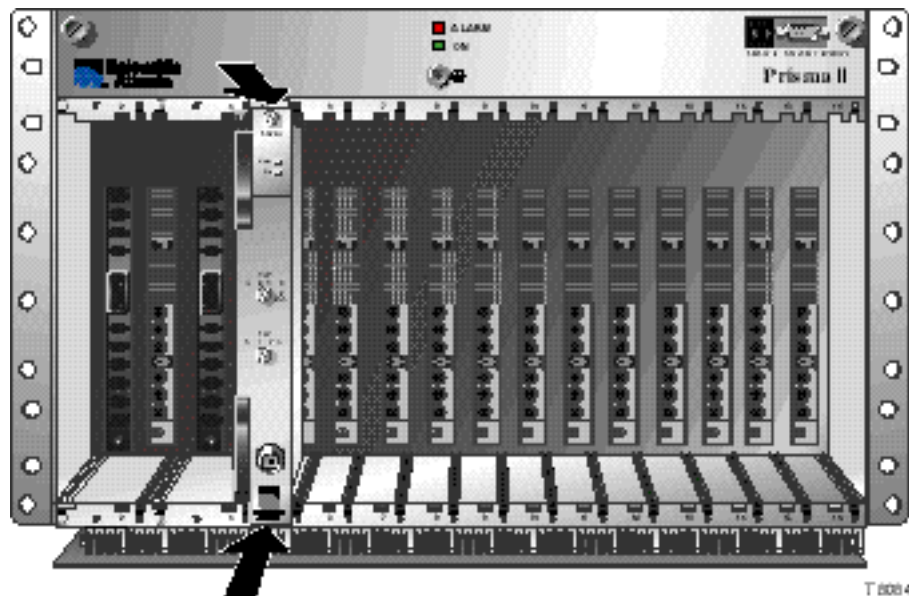

4. Secure the module by pressing the two ejectors located on the left side of the module until they lay flat. When the levers are flat, the power and communications connections at the rear of the module mates with the communications connectors at the back of the chassis slot.
5. Hand-tighten the screw at the top of the module, to secure it in the chassis. Use a  $\frac{3}{8}$ -in. flat-blade screwdriver to secure. **Do not overtighten.**

# Chapter 3 Operation

## Overview

---

### Introduction

This chapter gives operating instructions for the Prisma II Forward Headend Driver Amplifier and the Prisma II Reverse Headend Driver Amplifier.

### Qualified Personnel

Only appropriately qualified and trained personnel should attempt to operate this equipment.



**WARNING:**

**Allow only qualified personnel to install, operate, maintain, or service this product. otherwise, personal injury or equipment damage may occur.**

### In This Chapter

This chapter contains the following topics.

Topic	See Page
Operating the HEDA	3-2
Ensuring Proper Signal Strength and Adjusting the Selectable Pad	3-4
Ensuring a Flat Output Signal by Adjusting the Step Equalizer	3-5
Checking the Operating Settings	3-7

# Operating the HEDA

## Operation

Once the HEDA is installed as described in Chapter 2, it runs without the aid of an operator. During normal operation, the amplifier indicators function in this manner.

- The green ON indicator is illuminated
- The red ALARM indicator is off

Forward HEDA

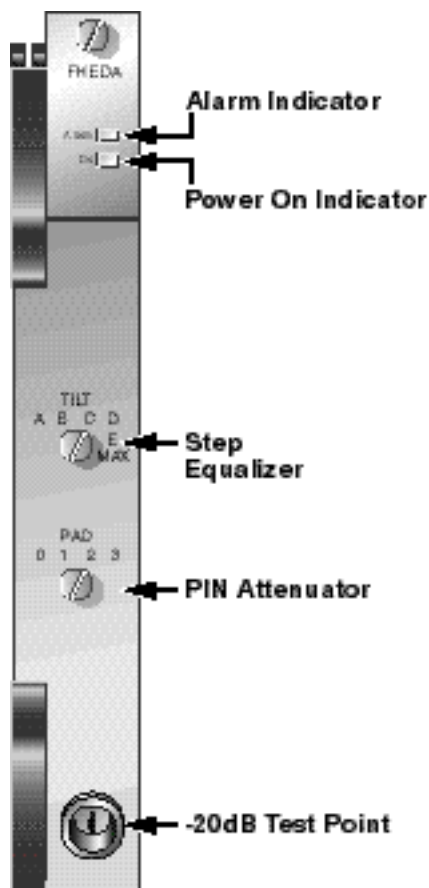

Reverse HEDA

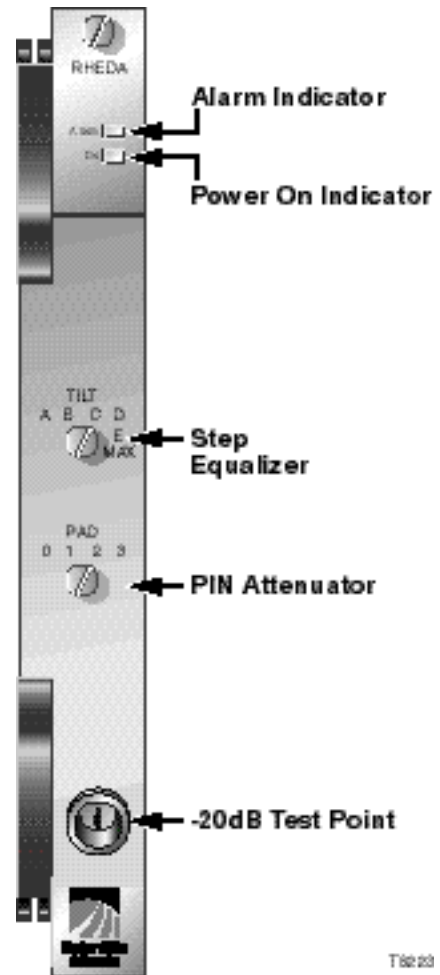

T8020



## Operating the HEDA, Continued

---

### Verifying RF Output

It is important to make sure that RF output is within the desired range before you adjust the variable pad and equalizer. Otherwise, the HEDA will not operate properly.

Follow the procedure below to verify the RF output of the HEDA.

1. On the back of the chassis, locate the port for RF output used by the amplifier.

**Note:** Output connectors are on Port B row.

2. Using a 7/16-in. open-end wrench, disconnect the RF cable designated for the RF output of the amplifier and connect a test cable from the RF output connector to a spectrum analyzer. Torque the connector to the specifications given by the connector manufacturer. **Do not over tighten.**
3. Measure output level of the amplifier for the lowest carrier level.
4. Verify that when the variable pad is set to 0, the RF output level of the amplifier is within +3 dBmV of the desired input level of the device being fed.

<b>IF the amplifier RF output is . . .</b>	<b>THEN . . .</b>
within +3 dBmV of the desired transmitter input level	record this value in your Maintenance Log. Refer to the sample <b>Maintenance Log</b> in appendix A.
more than +3 dBmV of the desired transmitter input level	refer to the appropriate section in Chapter 4 for assistance in troubleshooting.
less than the desired input level	refer to the appropriate section in Chapter 4 for assistance in troubleshooting.

5. Go to the next procedure, **Ensuring Proper Signal Strength and Adjusting the Selectable Pad.**

# Ensuring Proper Signal Strength and Adjusting the Selectable Pad

---

## Variable Pad Adjustment Procedure

**Important:** The following procedure assumes that you have verified the RF output and that the selectable pad is set to 0.

To adjust the HEDA signal strength so that it meets the input requirements of the device being fed, you may need to add attenuation to the input signal. Otherwise, the amplifier will not operate properly. To ensure proper signal strength, follow these steps.

1. Check that the selectable pad is set to 0.
2. Compare the actual RF output level obtained in the previous procedure to the optimal input level required by the device to which the signal is being routed.

If the actual level is . . .	Then . . .
within $\pm 0.5$ dB of the optimal level	go to the next procedure, <b>Ensuring a Flat Output Signal by Adjusting the Variable Equalizer.</b>
more than 0.5 dB of the optimal level	increase the input attenuator pad. Refer to the next step.
less than 0.5 dB of the optimal level	refer to the appropriate section in Chapter 5 for assistance in troubleshooting.

3. Using a 1/8-in. flat-blade screwdriver, turn the pad setting on the front panel of the amplifier so the attenuation is correct for your operation. Refer to the following table.

Pad Setting	Amount of Attenuation
0	0 dB
1	1 dB
2	2 dB
3	3 dB

4. Once you have set the pad correctly, adjust the step equalizer to ensure a flat output signal. Refer to the following procedure, **Ensuring a Flat Output Signal by Adjusting the Step Equalizer.**

# Ensuring a Flat Output Signal by Adjusting the Step Equalizer

---

## Variable Equalizer Adjustment Procedure

**Important:** The following procedure assumes that you have adjusted the variable pad, if necessary, to ensure that the signal strength is correct.

For your system to operate properly, the output signal must remain flat across all channels. To use the step equalizer to ensure that the output signal is flat, follow these steps.

1. On the back of the chassis, locate the amplifier's RF output port.

**Note:** HEDA output connectors are on Port B row.

2. Using a 7/16-in. open-end wrench, disconnect the RF cable designated for the RF output of the amplifier and connect a test cable from the RF output connector to a spectrum analyzer. Torque the connector to the specifications given by the connector manufacturer. **Do not over tighten.**
3. Measure the output level at the highest system frequency and lowest system frequency.
4. Use the following formula to determine output tilt.

$$\text{Tilt} = L_{\text{High}} - L_{\text{Low}}$$

Where:

Tilt = amplitude difference between the highest and lowest frequency

$L_{\text{High}}$  = signal level of the highest frequency

$L_{\text{Low}}$  = signal level of the lowest frequency

5. Using a 1/8-in. flat-blade screwdriver, turn the tilt setting on the front panel of the amplifier so the signal is flat across all channels. Refer to the following table:

Tilt Setting	Amount of Signal Equalization	
	Forward	Reverse
A	0.0 dB	0.5 dB
B	1.0 dB	1.5 dB
C	2.0 dB	2.5 dB
D	3.0 dB	3.5 dB
E	4.0 dB	4.5 dB
MAX	5.0 dB	5.5 dB

## Ensuring a Flat Output Signal by Adjusting the Variable Equalizer, Continued

---

6. Using a 7/16-in. open-end wrench, disconnect the test cable and connect the RF cable to the RF output connector. Torque the connector to the specifications given by the connector manufacturer. **Do not overtighten.**
7. The amplifier is ready for normal operation.

# Checking the Operating Settings

---

## Preparing to Record Operating Data

To ensure that the amplifier is operating properly, it is recommended to periodically monitor and record operating data. Having a record of operating data also establishes a baseline of unit performance for use in maintenance and troubleshooting.

Before you begin, gather the equipment and tools listed in the following table:

You Need . . .	To . . .
a Maintenance Log	record new data and compare it against data recorded earlier.
a spectrum analyzer	verify proper HEDA operation.
a 75 ohm coax cable with an F-connector	connect to the spectrum analyzer to the amplifier test point.
1/8-in. flat-blade screwdriver	adjust the <b>PAD</b> and <b>TILT</b> settings, as needed.

## Check the RF Input

Complete the following steps to verify that the input level is within  $\pm 1.0$  dB of the value most recently recorded.

1. Connect an RF cable from the **-20 dB RF TEST** point on the front of the amplifier to the spectrum analyzer.
2. Set the spectrum analyzer for the frequency span of your band of operation.
3. Measure the signal level of the RF input test point.
4. Check that the input level to the amplifier is within  $\pm 1.0$  dB of the proper value. Remember to add 20 dB back to the measured **RF TEST** level to get the correct reading.

**Note:** If the reading is not within the proper range, refer to Chapter 4 for assistance in troubleshooting.

5. To complete weekly maintenance, go to the next procedure, **Checking RF Output**.

## Checking the Operating Settings, Continued

---

### Checking RF Output

Complete the following steps to verify that the output level is within  $\pm 1.0$  dB of the value most recently recorded.

**Note:** To check the RF output without taking the amplifier out of service, check the input test point of the module that the amplifier is feeding.

1. Connect an RF cable from the **RF TEST** point on the next inline module to the spectrum analyzer.
2. Set the spectrum analyzer for the frequency span of your bandwidth.
3. Measure the signal level and tilt and correct for the loss of that module's RF test point.
4. Check that the output level is within  $\pm 1.0$  dB of the value most recently recorded.

Note: If the reading is not within the proper range, refer to Chapter 4 for assistance in troubleshooting.

5. This portion of maintenance is complete. Record the reading.
6. To complete weekly maintenance, go to the next procedure, **Checking Pad and Tilt Settings**.

### Checking Pad and Tilt Settings

**Important:** The input and output levels must be verified before any adjustments are made to pad and tilt settings.

Complete the following steps to verify that the settings for pad and tilt are correct.

1. Refer to your Maintenance Log to determine the most recently recorded settings for pad and tilt.
2. Compare the recorded settings to the current settings. If either setting does not match, use a 1/8-in. flat-blade screwdriver and adjust the setting to the value most recently recorded. Or, refer to the appropriate procedure given earlier in this chapter.
  - **Ensuring Proper Signal Strength and Adjusting the Variable Pad**
  - **Ensuring a Flat Output Signal by Adjusting the Variable Equalizer**
3. Weekly maintenance is complete. Record the reading.

# Chapter 4

## Maintenance and Troubleshooting

### Overview

---

#### Introduction

This chapter describes the maintenance guidelines and troubleshooting procedures for the Prisma II HEDA.

#### Qualified Personnel

Only appropriately qualified and trained personnel should attempt to maintain or troubleshoot these products.



**WARNING:**

**Allow only qualified personnel to install, operate, maintain, and service these products. Otherwise, personal injury or equipment damage may occur.**

#### In This Chapter

This chapter contains the following topics.

Topic	See Page
HEDA Maintenance	4-2
General Troubleshooting Information	4-3
Troubleshooting Alarm Conditions	4-4
Power Supply Related Alarms	4-5

# HEDA Maintenance

---

## Maintaining the HEDA

To ensure optimal performance, the following maintenance is recommended.

<b>Frequency</b>	<b>Maintenance Required</b>
Weekly	<ul style="list-style-type: none"><li>• Check all parameters and test points</li><li>• Record data</li><li>• Make adjustments as needed</li></ul>
Quarterly	<ul style="list-style-type: none"><li>• Make sure all cables are mated properly</li><li>• Inspect cables for stress and chafing</li><li>• Make sure all retaining screws are tight</li></ul>
When needed	Carefully clean the module with a soft cloth that is dampened with mild detergent

## Maintenance Record

It may be helpful to establish a maintenance record or log for this module. You may want to record step equalizer, the PIN attenuator settings, and alarm indication information.



# General Troubleshooting Information

---

## Introduction

This troubleshooting information describes the most common alarms and gives typical symptoms, causes, and items to check before consulting Cisco.

## Equipment Needed

You may need the following equipment to troubleshoot these modules.

- Digital voltmeter
- Spectrum analyzer

## Additional Assistance

If you need additional assistance, telephone one of our Technical Service Centers or your local sales subsidiary. The Customer Support section in Chapter 5 contains a list of telephone numbers.

## Troubleshooting



### **WARNING:**

**Avoid electric shock and damage to this product! Do not open the enclosure of this product. There are no user-serviceable parts inside. Refer servicing to qualified service personnel.**

Refer to the following section, **Troubleshooting Alarm Conditions**, to identify and correct HEDA faults.

# Troubleshooting Alarm Conditions

---

## Headend Driver Amplifier Alarm Conditions

If the red ALARM indicator is illuminated or is blinking, check the table below to determine the cause of the alarm.

<b>Alarm</b>	<b>Status</b>	<b>Possible Causes</b>	<b>Possible Solutions</b>
ALARM Indicator Illuminated	Current Failure	Hybrid amplifier failure.	The module is faulty and should be replaced.
ALARM Indicator Blinking	Current too High or Low	Hybrid amplifier problem.	The module may be faulty and should be repaired or replaced.

# Power Supply Related Alarms

---

## Power Supply Related Alarms Solutions

Use the following table to locate the cause of a power supply related alarm.

<b>Alarm</b>	<b>Status</b>	<b>Possible Causes</b>	<b>Possible Solutions</b>
No Power Indication	No electrical power to HEDA	Loose, unplugged, or damaged chassis power cords.	Check the power supply, power cord, and connections.
		No AC at receptacle.	Check receptacle for AC power.
		A blown fuse on the power supply.	Check the power supply fuse. Repair or replace as needed.
		A faulty power supply module.	Verify proper power supply module operation. Repair or replace as needed.
		The HEDA is not seated properly in the chassis.	Check that the HEDA is securely connected to the chassis. Refer to the procedure in Chapter 2, <b>Installation</b> .
		A faulty module.	The module may be faulty and should be replaced.
		No power within chassis.	The chassis may have a problem. Contact Cisco Services for assistance.

# Chapter 5

## Customer Information

### Overview

---

#### Introduction

If you have technical questions, call Cisco Services for assistance. Follow the menu options to speak with a service engineer.

Access your company's extranet site to view or order additional technical publications. For accessing instructions, contact the representative who handles your account. Check your extranet site often as the information is updated frequently.

# Glossary

---

<b>Term, Acronym, Abbreviation</b>	<b>Meaning</b>
<b>A</b>	Ampere (amp) is the unit of measure for electrical current.
<b>AC</b>	Alternating current
<b>Addressable</b>	The ability to control an individual unit in a system of many similar units.
<b>AFC</b>	Automatic Frequency Control
<b>AGC</b>	Automatic Gain Control
<b>AM</b>	Amplitude Modulation
<b>Amplifier Cascade</b>	Two or more amplifiers in a series, the output of one feeding the input of another.
<b>ATC</b>	Automotive fuse
<b>Attenuation</b>	A decrease in signal magnitude occurring in transmission from one point to another or in passing through a loss medium.
<b>Attenuator</b>	A device designed to reduce signal strength by an amount specified in dB.
<b>ATX</b>	Addressable transmitter
<b>AUX</b>	Auxiliary
<b>Baseband</b>	The total signal before it is modified for transmission or otherwise manipulated.
<b>Baud (Bd)</b>	A measure of signaling rate based on the number of signaling events per unit of time
<b>bdr™</b>	Baseband digital reverse
<b>Beamwidth</b>	The included angle between two rays (usually the half-power points) on the radiation pattern, which includes the maximum lobe, of an antenna.
<b>BER</b>	Bit error rate

## Glossary, Continued

---

<b>BERT</b>	Bit error rate test
<b>BIG</b>	Broadband Integrated Gateway
<b>BIOS</b>	Basic Input/Output System
<b>BIST</b>	Built-in self-test
<b>Bit</b>	Short for Binary Digit. Can be either a "one" or a "zero."
<b>Blanking level</b>	The amplitude of the front and back porches of the composite video signal.
<b>BNC</b>	A coaxial connector that uses a bayonet type attachment to secure the cable. It is also known as Baby N connector.
<b>BPF</b>	Bandpass filter
<b>bps</b>	Bits per second - The total number of bits sent in a second of time.
<b>BPSK</b>	Binary Phase Shift Keying
<b>BW</b>	Bandwidth
<b>Byte</b>	A group of bits treated as a unit
<b>CF</b>	Continuous feed
<b>Circuit switching</b>	The type of signal switching traditionally used by telephone companies to create a physical connection between a caller and a called party.
<b>CIRD</b>	Commercial Integrated Receiver Decoder
<b>CIM</b>	Communications Interface Module
<b>CISC</b>	Complex Instruction Set Computer. A computer that uses many different types of instructions to conduct its operations, i.e., IBM PCs, Apple Macintosh's, IBM 370 mainframes.
<b>CIU</b>	Customer Interface Unit
<b>C/N or CNR</b>	Carrier-to-noise ratio

## Glossary, Continued

---

<b>Compression</b>	The non-linear change of gain at one level of a signal with respect to the change of gain at another level for the same signal. Also, the elimination of redundant information from an audio, data, or video signal to reduce transmission requirements.
<b>CSO</b>	Composite Second Order
<b>CTB</b>	Composite Triple Beat
<b>C/T</b>	Carrier-to-noise temperature ratio
<b>CW</b>	Continuous Wave
<b>dB</b>	Decibel
<b>dBc</b>	Decibels relative to a reference carrier
<b>DBDS</b>	Digital Broadband Delivery System
<b>dBm</b>	Decibels relative to 1 milliwatt
<b>dB<sub>i</sub></b>	Decibels of gain relative to an isotropic radiator
<b>dBuV</b>	Decibels relative to 1 microvolt
<b>dBW</b>	Decibels relative to 1 watt
<b>dBmV</b>	Decibels relative to 1 millivolt
<b>DC</b>	Direct current
<b>DC</b>	Directional coupler
<b>DES</b>	Data Encryption Standard
<b>Deviation</b>	The peak difference between the instantaneous frequency of the modulated wave and the carrier frequency, in an FM system.
<b>DFB</b>	Distributed feed back laser
<b>Differential gain</b>	The difference in amplification of a signal (superimposed on a carrier) between two different levels of carrier.
<b>Diplex filter</b>	A filter which divides the frequency spectrum into a high frequency segment and a low frequency segment so that two different signals can be sent down the same transmission path.

## Glossary, Continued

---

<b>Distribution System</b>	Part of a cable system consisting of trunk and feeder cables used to carry signals from headend to subscriber terminals.
<b>Downconverter</b>	A device that converts an input signal to a lower frequency output signal.
<b>Down link</b>	A transmission path carrying information from a satellite or spacecraft to earth.
<b>DP</b>	Data processing
<b>DPU</b>	Digital processing unit
<b>DSP</b>	Digital signal processor
<b>DSR</b>	Digital Storage and Retrieval System
<b>D to U</b>	Desired to undesired signal ratio
<b>DTMF</b>	Dual Tone Multiple Frequency
<b>Duplexer</b>	A device which permits the connection of both a receiver and a transmitter to a common antenna.
<b>DVM</b>	Digital voltmeter
<b>DWDM</b>	Dense Wave Division Multiplexing
<b>ECM</b>	Entitlement Control Message
<b>EDFA</b>	Erbium Doped Fiber Amplifier
<b>EEPROM</b>	Electrically Erasable Programmable Read-Only Memory
<b>EIA</b>	Electronics Industry Association
<b>EMI</b>	Electromagnetic interference
<b>Emission designer</b>	An FCC or CCIR code that defines the format of radiation from a transmitter.
<b>EPROM</b>	Erasable Programmable Read-Only Memory
<b>EQ</b>	Equalizer
<b>Equalization</b>	The process of compensating for an undesired result. For example, equalizing tilt in a distribution system.
<b>ERP</b>	Effective radiated power



## Glossary, Continued

---

<b>FAOC</b>	Frequency agile output converters
<b>FET</b>	Field-effect transistor
<b>FIFO</b>	First in, first out
<b>FM</b>	Frequency modulation
<b>Forward path</b>	Signal direction from the headend to the set-top terminal.
<b>FP</b>	Fabry-Perot laser
<b>Fiber</b>	A single strand of glass used as an optical transmission medium; or a bundle of glass strands in a CATV system.
<b>Frequency</b>	The number of similar shapes in a unit of time. For example, the number of sine waves moving past a fixed point in a second.
<b>Frequency Agile</b>	The ability to change from one frequency to another without changing components.
<b>Frequency Modulation</b>	A system of modulation where the instantaneous radio frequency of the carrier varies in proportion to the instantaneous amplitude of the modulating signal while the amplitude of the radio frequency carrier is independent of the amplitude of the modulating signal.
<b>Frequency Response</b>	The effect that changing the frequency has on the magnitude of a signal.
<b>Frequency Reuse</b>	A technique in which independent information is transmitted on orthogonal polarizations to "reuse" a given band of frequencies.
<b>Frequency Stability</b>	A measure of the departure from nominal frequency value of a signal, with respect to time, temperature, or other influence.
<b>FSM</b>	Field strength meter
<b>FSK</b>	Frequency-shift keying
<b>ft-lb.</b>	Foot-pound
<b>FTP</b>	File Transfer Protocol
<b>Gain</b>	An increase in signal relative to a reference
<b>Gbps</b>	Gigabits per second

## Glossary, Continued

---

<b>Headend</b>	Location and equipment that receives data from a satellite (or other) source and reformats that data for input to a broadband distribution network
<b>HEDA</b>	Headend Driver Amplifier
<b>HGD</b>	High Gain Dual
<b>Hertz</b>	A unit of frequency equal to one cycle per second.
<b>Hetrodyne</b>	Changing the frequency of a signal by mixing it with another signal to get the sum and difference of the two.
<b>I/O</b>	Input/output
<b>IC</b>	Integrated circuit
<b>ICIM</b>	Intelligent Communications Interface Module
<b>ICP</b>	Internal Control Program. A series of policies to protect company sensitive and export controlled information.
<b>IDR</b>	Intermediate Data Rate
<b>IEC</b>	International Electrotechnical Commission
<b>IF</b>	Intermediate frequency
<b>IFL</b>	Interfacility link
<b>IP</b>	Internet protocol
<b>Kbps</b>	Kilobits per second
<b>in-lb</b>	Inch-pound
<b>LCD</b>	Liquid crystal display
<b>LCI</b>	Local craft interface
<b>LED</b>	Light-emitting diode
<b>LIFO</b>	Last-in, first-out
<b>LNA</b>	Low-noise amplifier
<b>LNB</b>	Low-noise block converter

## Glossary, Continued

---

<b>LNC</b>	Low-noise converter
<b>LOCATE(TM)</b>	Systems for monitoring, analyzing, or reporting electric power outages
<b>Mbps</b>	Megabits per second
<b>MCU</b>	Master Control Unit
<b>Multipath (multipath transmission)</b>	The phenomenon which results from a signal traveling from point to point by more than one path so that several copies of the signal arrive at the destination at different times or at different angles.
<b>mux</b>	multiplexed
<b>Nanosecond</b>	1 thousandth of a microsecond
<b>Nm</b>	Newton meter
<b>NIU</b>	Network Interface Unit
<b>Node</b>	A branching or exchange point
<b>OEM</b>	Original equipment manufacturer
<b>OOB</b>	Out of band
<b>OIM</b>	Optical interface module
<b>PCB</b>	Printed circuit board
<b>PCM</b>	Pulse code modulation
<b>PDI</b>	Pressure differential indicator
<b>PDU</b>	Power distribution unit
<b>PLL</b>	Phase Lock Loop. An electronic servo system controlling an oscillator to maintain a constant phase angle relative to a reference signal.
<b>PROM</b>	Programmable Read Only Memory
<b>PWB</b>	Printed wiring board
<b>QAM</b>	Quadrature Amplitude Modulation
<b>QPR</b>	Quadrature Partial Response

## Glossary, Continued

---

<b>QPSK</b>	Quadrature Phase-Shift Keying
<b>RC</b>	Reverse conditioner
<b>Reverse path</b>	Signal flow direction toward the headend.
<b>RF</b>	Radio frequency
<b>RF Bypass</b>	A bypass feature that allows subscribers to view a clear analog channel while recording a digital or analog channel on a VCR.
<b>RFI</b>	Radio frequency interference
<b>RMA</b>	Return material authorization
<b>RMS</b>	Root Mean Square
<b>Router</b>	A data communications device which examines a packet and routes the packet to an output port appropriate to the packet destination
<b>RS</b>	Remote Sensing
<b>RX</b>	Receive or receiver
<b>SA</b>	Spectrum analyzer
<b>SAM</b>	Signal analysis meter
<b>SAT</b>	Site acceptance test
<b>S-band</b>	The group of frequencies between 2 and 4 GHz.
<b>SET</b>	Secure electronic transaction
<b>Scattering</b>	Random directional change of a wave or part of a wave caused by an irregular reflecting surface or by passing through an inhomogeneous transmission medium.
<b>SLM</b>	Signal level meter
<b>SM</b>	Status monitor
<b>SMC</b>	Status monitoring and control
<b>SMIU</b>	Status Monitor Interface Unit
<b>SMU</b>	Server Management Unit
<b>S/N or SNR</b>	Signal-to-noise ratio

## Glossary, Continued

---

<b>SNMP</b>	Simple Network Management Protocol
<b>SP</b>	Splitter. It is a device which divides power from an input to deliver multiple outputs or combines multiple inputs into one output.
<b>Spread Spectrum</b>	A modulation technique to spread a narrow band signal over a wide band of frequencies.
<b>Spurious</b>	Anything other than the desired result
<b>SSPA</b>	Solid-state power amplifier
<b>Sweep generator</b>	A signal source which can automatically vary its frequency continuously from one frequency to another.
<b>Synchronous transmission</b>	A method of sending information over a path and separating discrete characters and symbols by a precise separation in time.
<b>TCP/IP</b>	Transmission control protocol/internet protocol
<b>TDM</b>	Time division multiplexing
<b>TNCS</b>	Transmission Network Control System
<b>Torque</b>	Force applied to bolt or screw to tighten the device.
<b>TS</b>	Transport Stream
<b>TTCN</b>	True tilt correction network
<b>Tx</b>	Transmit or transmitter
<b>UBT</b>	Unbalanced triple
<b>UPS</b>	Un-interruptible power supply
<b>Upstream</b>	Signal transmission toward the headend
<b>UTP</b>	Unshielded twisted pair
<b>uV</b>	One millionth of a volt (microvolt)
<b>V</b>	Volt
<b>V AC</b>	Volts alternating current
<b>VBR</b>	Variable bit rate

## Glossary, Continued

---

<b>VCA</b>	Voltage controlled attenuator
<b>V DC</b>	Volts direct current
<b>VOD</b>	Video-on-demand
<b>VOM</b>	Volt ohm meter
<b>W</b>	Watts
<b>WDM</b>	Wave Division Multiplexing
<b>YEDFA</b>	Ytterbium/Erbium Doped Fiber Amplifier



Cisco Systems, Inc.  
5030 Sugarloaf Parkway, Box 465447  
Lawrenceville, GA 30042

678 277-1120  
800 722-2009  
[www.cisco.com](http://www.cisco.com)

This document includes various trademarks of Cisco Systems, Inc. Please see the Notices section of this document for a list of the Cisco Systems, Inc. trademarks used in this document.

Product and service availability are subject to change without notice.

© 2001, 2008, 2012 Cisco and/or its affiliates. All rights reserved.

September 2012 Printed in USA

Part Number 78-715189-01 Rev C