









Prisma II 1310 nm High Density Transmitter Installation and Operation Guide

For Your Safety

Explanation of Warning and Caution Icons

Avoid personal injury and product damage! Do not proceed beyond any symbol until you fully understand the indicated conditions.

The following warning and caution icons alert you to important information about the safe operation of this product:

-  You may find this symbol in the document that accompanies this product. This symbol indicates important operating or maintenance instructions.
-  You may find this symbol affixed to the product. This symbol indicates a live terminal where a dangerous voltage may be present; the tip of the flash points to the terminal device.
-  You may find this symbol affixed to the product. This symbol indicates a protective ground terminal.
-  You may find this symbol affixed to the product. This symbol indicates a chassis terminal (normally used for equipotential bonding).
-  You may find this symbol affixed to the product. This symbol warns of a potentially hot surface.
-  You may find this symbol affixed to the product and in this document. This symbol indicates an infrared laser that transmits intensity-modulated light and emits invisible laser radiation or an LED that transmits intensity-modulated light.

Important

Please read this entire guide. If this guide provides installation or operation instructions, give particular attention to all safety statements included in this guide.

Notices

Trademark Acknowledgments

Cisco and the Cisco logo are trademarks or registered trademarks of Cisco and/or its affiliates in the U.S. and other countries. A listing of Cisco's trademarks can be found at www.cisco.com/go/trademarks.

Third party trademarks mentioned are the property of their respective owners.

The use of the word partner does not imply a partnership relationship between Cisco and any other company. (1110R)

Publication Disclaimer

Cisco Systems, Inc. assumes no responsibility for errors or omissions that may appear in this publication. We reserve the right to change this publication at any time without notice. This document is not to be construed as conferring by implication, estoppel, or otherwise any license or right under any copyright or patent, whether or not the use of any information in this document employs an invention claimed in any existing or later issued patent.

Copyright

© 2008, 2013 Cisco and/or its affiliates. All rights reserved. Printed in the United States of America.

Information in this publication is subject to change without notice. No part of this publication may be reproduced or transmitted in any form, by photocopy, microfilm, xerography, or any other means, or incorporated into any information retrieval system, electronic or mechanical, for any purpose, without the express permission of Cisco Systems, Inc.

Contents

Important Safety Instructions	ix
Laser Safety	xix
Laser Power and Warning Labels	xxi
Chapter 1 Module Introduction	1
High Density Transmitter Description	3
High Density Transmitter Features.....	3
High Density Transmitter Operation.....	3
High Density Transmitter Optical Output.....	4
Laser Warning.....	4
High Density Transmitter Block Diagram	4
High Density Transmitter Front and Back Panel	5
High Density Transmitter Illustration	5
High Density Transmitter Front Panel Features	5
Back Panel Connectors.....	6
Host Module.....	7
Host Module Features.....	7
Host Module Illustration	7
Host Module Back Panel Connectors.....	8
Module Configuration	9
Configuration and Monitoring Methods.....	9
Configuration Summary	10
Chapter 2 Module Installation	11
Preparing for Installation.....	12
Equipment and Tools Needed	12
Unpacking and Inspecting the Module	12
Site Requirements	13
Access Requirements.....	13
Equipment Rack.....	13
Operating Environment	13
Power Requirements	13
Space Requirements	14
Prisma II Chassis Style	14
Prisma II XD Chassis Style	16

Connecting the RF Cables to the Chassis	17
To Connect RF Cables for Each Module	17
Installing the Module in the Chassis.....	19
To Install the Transmitter Modules in the Host Module	19
To Install the Host Module in the Chassis	20
To Install the Module in a Prisma II XD Chassis.....	21
Connecting Optical Cables	23
Fiber Fish Tool.....	23
Fiber Fish Tool Hook.....	23
To Pull the Optical Cable to the Module	23
Optical Connector Cleaning Overview.....	24
Recommended Equipment.....	24
Tips for Optimal Fiber-Optic Connector Performance.....	24
To Clean Optical Connectors	25
To Connect Optical Cables to Module	26
Connecting the ICIM to Additional Chassis	27
Chassis-to-Chassis ICIM Connections	27
ICIM IN and ICIM OUT Connectors.....	27
ICIM IN and ICIM OUT Cables.....	27
To Connect Chassis-to-Chassis ICIM IN and ICIM OUT Ports	28
Connecting a Chassis to the TNCS Server.....	29
Cable Kits for Connecting a Chassis to the TNCS Server	29
To Connect TNCS to the Chassis EM IN Port.....	29
Using TNCS with Multiple Chassis	30
External Alarms Connections.....	31
Master/Slave Operation	31
ALARMS IN and ALARMS OUT Connectors.....	31
ALARMS IN and ALARMS OUT Connector Illustration.....	32
Master/Slave Illustration.....	32
Redundancy Interface Panel.....	33
Prisma II Redundancy Interface Panel Illustrations	33

Chapter 3 Operation using ICIM 35

ICIM Introduction.....	37
Laser Warning	37
ICIM Function	37
ICIM Block Diagram.....	38
ICIM2 Front Panel.....	39
ICIM2 Illustration (Front Panel)	39
ICIM2 Front Panel Features.....	40
ICIM LCD.....	40
ICIM MAIN Menu Illustration	40
ICIM Keypad	41
ICIM Password.....	42
Password Protection System	42

To Access the Password Menu	42
Expired Password or Inactive Password Messages	43
To Enter the User Password	43
To Change the User Password	44
To Disable the User Password using ICIM	45
Operating the ICIM	47
Using the ICIM.....	47
To Access the ICIM LCD Contrast	47
ICIM MAIN Menu	47
ICIM MAIN Menu Illustration	48
Prisma II ICIM Menu.....	48
Prisma II MAIN Menu and ICIM Menu Structure.....	49
Prisma II Transmitter Module Software Menu Structure	50
Setting SNMP Trap Receiver Parameters	51
To Set Traps for a Specific IP Address using P2TrapRecvEntry	51
Checking the Operating Status using the ICIM.....	52
To Check the Operating Status using ICIM	52
STATUS Menus.....	53
Configuring the Module using the ICIM.....	54
To Configure Parameters using the ICIM	54
CONFIG Menus	54
Checking Module Alarms using the ICIM	56
To Check Alarms using ICIM	56
ALARMS Menus	57
To Set Adjustable Alarm Thresholds using the ICIM.....	57
Alarm Threshold Menus.....	58
Checking Manufacturing Data using the ICIM	59
To Check Manufacturing Data.....	59
MFG. DATA Menus	60
Saving the Configuration using the ICIM	61
To Save the Current Configuration	61
Configuration Complete	61
SNMP Configuration.....	62
SNMP Considerations.....	62
Basic SNMP Setup.....	62
To Set Up the IP Configuration Parameters for SNMP Support using ICIM.....	62
To Restart the ICIM by Removing the ICIM.....	64
Community Names	65
Default Community Strings	65
New SNMP Variables.....	66
Table of Inserted Modules	66
Table of Removed Modules.....	66
Previous IP Address	67
Boot Dialog for ICIM/SNMP Configuration	68
To Prepare to Change Parameters	69

To Change Parameters	70
To Restart the ICIM using ICIM	70
Adjusting Alarm Thresholds.....	71
To Adjust Alarm Thresholds.....	71

Chapter 4 Operation using LCI 73

LCI Introduction	74
Laser Warning	74
LCI Function	74
System Requirements	75
Computer Requirements.....	75
Cable Requirements.....	75
Installing LCI.....	76
To Install the LCI Software.....	76
Connecting Your Computer to the Chassis.....	79
To Connect a Computer to the Chassis.....	79
Starting LCI Software	81
To Start LCI Software	81
LCI Module Tree	83
Introduction.....	83
Module Tree.....	83
Accessing the Module Detail Information	84
Module Details Window	84
To Access the Module Details, Double-Click the Chassis.....	85
To Access the Module Details, Right-Click the Chassis	86
To Access the Module Details, Double-Click the Module	87
To Access the Module Details, Right-Click the Module.....	88
Checking the Operating Status	89
To Check the Operating Status using LCI.....	89
Configuring the Module using LCI.....	91
To Configure Parameters using LCI	91
Checking the Module Alarms using LCI.....	93
To Check Alarms using LCI.....	93
Modifying Module Alarm Limits using LCI.....	95
To Modify Alarm Limits using LCI.....	95
Checking Manufacturing Data using LCI	97
To Check Manufacturing Data using LCI	97

Chapter 5 Maintenance and Troubleshooting	99
Maintenance.....	100
Maintenance Record	100
General Troubleshooting Information.....	101
Equipment Needed.....	101
Additional Assistance	101
Troubleshooting	101
Troubleshooting Alarm Conditions	102
Module Alarm Conditions	102
Chapter 6 Customer Support Information	103
Appendix A Module Parameter Descriptions	105
High Density Transmitter Parameters	106
Operating Status Parameters.....	106
Configurable Parameters	107
Alarm Data Parameters.....	108
Manufacturing Data Parameter Examples	109
Glossary	111
Index	115

Important Safety Instructions

Read and Retain Instructions

Carefully read all safety and operating instructions before operating this equipment, and retain them for future reference.

Follow Instructions and Heed Warnings

Follow all operating and use instructions. Pay attention to all warnings and cautions in the operating instructions, as well as those that are affixed to this equipment.

Terminology

The terms defined below are used in this document. The definitions given are based on those found in safety standards.

Service Personnel - The term *service personnel* applies to trained and qualified individuals who are allowed to install, replace, or service electrical equipment. The service personnel are expected to use their experience and technical skills to avoid possible injury to themselves and others due to hazards that exist in service and restricted access areas.

User and Operator - The terms *user* and *operator* apply to persons other than service personnel.

Ground(ing) and Earth(ing) - The terms *ground(ing)* and *earth(ing)* are synonymous. This document uses *ground(ing)* for clarity, but it can be interpreted as having the same meaning as *earth(ing)*.

Electric Shock Hazard

This equipment meets applicable safety standards.



WARNING:

To reduce risk of electric shock, perform only the instructions that are included in the operating instructions. Refer all servicing to qualified service personnel only.

Electric shock can cause personal injury or even death. Avoid direct contact with dangerous voltages at all times. The protective ground connection, where provided, is essential to safe operation and must be verified before connecting the power supply.

Important Safety Instructions

Know the following safety warnings and guidelines:

- **Dangerous Voltages**
 - Only qualified service personnel are allowed to perform equipment installation or replacement.
 - Only qualified service personnel are allowed to remove chassis covers and access any of the components inside the chassis.
- **Grounding**
 - Do not violate the protective grounding by using an extension cable, power cable, or autotransformer without a protective ground conductor.
 - Take care to maintain the protective grounding of this equipment during service or repair and to re-establish the protective grounding before putting this equipment back into operation.

Installation Site

When selecting the installation site, comply with the following:

- **Protective Ground** - The protective ground lead of the building's electrical installation should comply with national and local requirements.
- **Environmental Condition** - The installation site should be dry, clean, and ventilated. Do not use this equipment where it could be at risk of contact with water. Ensure that this equipment is operated in an environment that meets the requirements as stated in this equipment's technical specifications, which may be found on this equipment's data sheet.

Installation Requirements



WARNING:

Allow only qualified service personnel to install this equipment. The installation must conform to all local codes and regulations.

Equipment Placement

**WARNING:**

Avoid personal injury and damage to this equipment. An unstable mounting surface may cause this equipment to fall.

To protect against equipment damage or injury to personnel, comply with the following:

- Install this equipment in a restricted access location.
- Do not install near any heat sources such as radiators, heat registers, stoves, or other equipment (including amplifiers) that produce heat.
- Place this equipment close enough to a mains AC outlet to accommodate the length of this equipment's power cord.
- Route all power cords so that people cannot walk on, place objects on, or lean objects against them. This may pinch or damage the power cords. Pay particular attention to power cords at plugs, outlets, and the points where the power cords exit this equipment.
- Use only with a cart, stand, tripod, bracket, or table specified by the manufacturer, or sold with this equipment.
- Make sure the mounting surface or rack is stable and can support the size and weight of this equipment.
- The mounting surface or rack should be appropriately anchored according to manufacturer's specifications. Ensure this equipment is securely fastened to the mounting surface or rack where necessary to protect against damage due to any disturbance and subsequent fall.

Ventilation

This equipment has openings for ventilation to protect it from overheating. To ensure equipment reliability and safe operation, do not block or cover any of the ventilation openings. Install the equipment in accordance with the manufacturer's instructions.

Rack Mounting Safety Precautions

Mechanical Loading

Make sure that the rack is placed on a stable surface. If the rack has stabilizing devices, install these stabilizing devices before mounting any equipment in the rack.



WARNING:

Avoid personal injury and damage to this equipment. Mounting this equipment in the rack should be such that a hazardous condition is not caused due to uneven mechanical loading.

Reduced Airflow

When mounting this equipment in the rack, do not obstruct the cooling airflow through the rack. Be sure to mount the blanking plates to cover unused rack space. Additional components such as combiners and net strips should be mounted at the back of the rack, so that the free airflow is not restricted.



CAUTION:

Installation of this equipment in a rack should be such that the amount of airflow required for safe operation of this equipment is not compromised.

Elevated Operating Ambient Temperature

Only install this equipment in a humidity- and temperature-controlled environment that meets the requirements given in this equipment's technical specifications.



CAUTION:

If installed in a closed or multi-unit rack assembly, the operating ambient temperature of the rack environment may be greater than room ambient temperature. Therefore, install this equipment in an environment compatible with the manufacturer's maximum rated ambient temperature.

Handling Precautions

When moving a cart that contains this equipment, check for any of the following possible hazards:



WARNING:



Avoid personal injury and damage to this equipment! Move any equipment and cart combination with care. Quick stops, excessive force, and uneven surfaces may cause this equipment and cart to overturn.

- Use caution when moving this equipment/cart combination to avoid injury from tip-over.

- If the cart does not move easily, this condition may indicate obstructions or cables that may need to be disconnected before moving this equipment to another location.
- Avoid quick stops and starts when moving the cart.
- Check for uneven floor surfaces such as cracks or cables and cords.

Grounding

This section provides instructions for verifying that the equipment is properly grounded.

Safety Plugs (USA Only)

This equipment may be equipped with either a 3-terminal (grounding-type) safety plug or a 2-terminal (polarized) safety plug. The wide blade or the third terminal is provided for safety. Do not defeat the safety purpose of the grounding-type or polarized safety plug.

To properly ground this equipment, follow these safety guidelines:

- **Grounding-Type Plug** - For a 3-terminal plug (one terminal on this plug is a protective grounding pin), insert the plug into a grounded mains, 3-terminal outlet.
Note: This plug fits only one way. If this plug cannot be fully inserted into the outlet, contact an electrician to replace the obsolete 3-terminal outlet.
- **Polarized Plug** - For a 2-terminal plug (a polarized plug with one wide blade and one narrow blade), insert the plug into a polarized mains, 2-terminal outlet in which one socket is wider than the other.
Note: If this plug cannot be fully inserted into the outlet, try reversing the plug. If the plug still fails to fit, contact an electrician to replace the obsolete 2-terminal outlet.

Grounding Terminal

If this equipment is equipped with an external grounding terminal, attach one end of an 18-gauge wire (or larger) to the grounding terminal; then, attach the other end of the wire to a ground, such as a grounded equipment rack.

Safety Plugs (European Union)

- **Class I Mains Powered Equipment** - Provided with a 3-terminal AC inlet and requires connection to a 3-terminal mains supply outlet via a 3-terminal power cord for proper connection to the protective ground.
Note: The equipotential bonding terminal provided on some equipment is not designed to function as a protective ground connection.

Important Safety Instructions

- **Class II Mains Powered Equipment** – Provided with a 2-terminal AC inlet that may be connected by a 2-terminal power cord to the mains supply outlet. No connection to the protective ground is required as this class of equipment is provided with double or reinforced and/or supplementary insulation in addition to the basic insulation provided in Class I equipment.

Note: Class II equipment, which is subject to EN 50083-1, is provided with a chassis mounted equipotential bonding terminal. See the section titled **Equipotential Bonding** for connection instructions.

Equipotential Bonding

If this equipment is equipped with an external chassis terminal marked with the IEC 60417-5020 chassis icon () , the installer should refer to CENELEC standard EN 50083-1 or IEC standard IEC 60728-11 for correct equipotential bonding connection instructions.

AC Power

Important: If this equipment is a Class I equipment, it must be grounded.

- If this equipment plugs into an outlet, the outlet must be near this equipment, and must be easily accessible.
- Connect this equipment only to the power sources that are identified on the equipment-rating label normally located close to the power inlet connector(s).
- This equipment may have two power sources. Be sure to disconnect all power sources before working on this equipment.
- If this equipment **does not** have a main power switch, the power cord connector serves as the disconnect device.
- Always pull on the plug or the connector to disconnect a cable. Never pull on the cable itself.
- Unplug this equipment when unused for long periods of time.

Connection to -48 V DC/-60 V DC Power Sources

If this equipment is DC-powered, refer to the specific installation instructions in this manual or in companion manuals in this series for information on connecting this equipment to nominal -48 V DC/-60 V DC power sources.

Circuit Overload

Know the effects of circuit overloading before connecting this equipment to the power supply.



CAUTION:

Consider the connection of this equipment to the supply circuit and the effect that overloading of circuits might have on overcurrent protection and supply wiring. Refer to the information on the equipment-rating label when addressing this concern.

General Servicing Precautions



WARNING:

Avoid electric shock! Opening or removing this equipment's cover may expose you to dangerous voltages.



CAUTION:

These servicing precautions are for the guidance of qualified service personnel only. To reduce the risk of electric shock, do not perform any servicing other than that contained in the operating instructions unless you are qualified to do so. Refer all servicing to qualified service personnel.

Be aware of the following general precautions and guidelines:

- **Servicing** - Servicing is required when this equipment has been damaged in any way, such as power supply cord or plug is damaged, liquid has been spilled or objects have fallen into this equipment, this equipment has been exposed to rain or moisture, does not operate normally, or has been dropped.
- **Wristwatch and Jewelry** - For personal safety and to avoid damage of this equipment during service and repair, do not wear electrically conducting objects such as a wristwatch or jewelry.
- **Lightning** - Do not work on this equipment, or connect or disconnect cables, during periods of lightning.
- **Labels** - Do not remove any warning labels. Replace damaged or illegible warning labels with new ones.
- **Covers** - Do not open the cover of this equipment and attempt service unless instructed to do so in the instructions. Refer all servicing to qualified service personnel only.
- **Moisture** - Do not allow moisture to enter this equipment.
- **Cleaning** - Use a damp cloth for cleaning.
- **Safety Checks** - After service, assemble this equipment and perform safety checks to ensure it is safe to use before putting it back into operation.

Electrostatic Discharge

Electrostatic discharge (ESD) results from the static electricity buildup on the human body and other objects. This static discharge can degrade components and cause failures.

Take the following precautions against electrostatic discharge:

- Use an anti-static bench mat and a wrist strap or ankle strap designed to safely ground ESD potentials through a resistive element.
- Keep components in their anti-static packaging until installed.
- Avoid touching electronic components when installing a module.

Fuse Replacement

To replace a fuse, comply with the following:

- Disconnect the power before changing fuses.
- Identify and clear the condition that caused the original fuse failure.
- Always use a fuse of the correct type and rating. The correct type and rating are indicated on this equipment.

Batteries

This product may contain batteries. Special instructions apply regarding the safe use and disposal of batteries:

Safety

- Insert batteries correctly. There may be a risk of explosion if the batteries are incorrectly inserted.
- Do not attempt to recharge 'disposable' or 'non-reusable' batteries.
- Please follow instructions provided for charging 'rechargeable' batteries.
- Replace batteries with the same or equivalent type recommended by manufacturer.
- Do not expose batteries to temperatures above 100°C (212°F).

Disposal

- The batteries may contain substances that could be harmful to the environment
- Recycle or dispose of batteries in accordance with the battery manufacturer's instructions and local/national disposal and recycling regulations.



廢電池請回收

- The batteries may contain perchlorate, a known hazardous substance, so special handling and disposal of this product might be necessary. For more information about perchlorate and best management practices for perchlorate-containing substance, see www.dtsc.ca.gov/hazardouswaste/perchlorate.

Modifications

This equipment has been designed and tested to comply with applicable safety, laser safety, and EMC regulations, codes, and standards to ensure safe operation in its intended environment. Refer to this equipment's data sheet for details about regulatory compliance approvals.

Do not make modifications to this equipment. Any changes or modifications could void the user's authority to operate this equipment.

Modifications have the potential to degrade the level of protection built into this equipment, putting people and property at risk of injury or damage. Those persons making any modifications expose themselves to the penalties arising from proven non-compliance with regulatory requirements and to civil litigation for compensation in respect of consequential damages or injury.

Accessories

Use only attachments or accessories specified by the manufacturer.

Electromagnetic Compatibility Regulatory Requirements

This equipment meets applicable electromagnetic compatibility (EMC) regulatory requirements. Refer to this equipment's data sheet for details about regulatory compliance approvals. EMC performance is dependent upon the use of correctly shielded cables of good quality for all external connections, except the power source, when installing this equipment.

- Ensure compliance with cable/connector specifications and associated installation instructions where given elsewhere in this manual.

Important Safety Instructions

Otherwise, comply with the following good practices:

- Multi-conductor cables should be of single-braided, shielded type and have conductive connector bodies and backshells with cable clamps that are conductively bonded to the backshell and capable of making 360° connection to the cable shielding. Exceptions from this general rule will be clearly stated in the connector description for the excepted connector in question.
- Ethernet cables should be of single-shielded or double-shielded type.
- Coaxial cables should be of the double-braided shielded type.

EMC Compliance Statements

Where this equipment is subject to USA FCC and/or Industry Canada rules, the following statements apply:

FCC Statement for Class A Equipment

This equipment has been tested and found to comply with the limits for a Class A digital device, pursuant to Part 15 of the FCC Rules. These limits are designed to provide reasonable protection against harmful interference when this equipment is operated in a commercial environment.

This equipment generates, uses, and can radiate radio frequency energy and, if not installed and used in accordance with the instruction manual, may cause harmful interference to radio communications. Operation of this equipment in a residential area is likely to cause harmful interference in which case users will be required to correct the interference at their own expense.

Industry Canada - Industrie Canadienne Statement

This apparatus complies with Canadian ICES-003.
Cet appareil est conforme à la norme NMB-003 du Canada.

CENELEC/CISPR Statement with Respect to Class A Information Technology Equipment

This is a Class A equipment. In a domestic environment this equipment may cause radio interference in which case the user may be required to take adequate measures.

Laser Safety

Introduction

This equipment contains an infrared laser that transmits intensity-modulated light and emits invisible radiation.

Warning: Radiation



WARNING:

- **Avoid personal injury! Use of controls, adjustments, or procedures other than those specified herein may result in hazardous radiation exposure.**
 - **Avoid personal injury! The laser light source on this equipment (if a transmitter) or the fiber cables connected to this equipment emit invisible laser radiation. Avoid direct exposure to the laser light source.**
 - **Avoid personal injury! Viewing the laser output (if a transmitter) or fiber cable with optical instruments (such as eye loupes, magnifiers, or microscopes) may pose an eye hazard.**
- Do not apply power to this equipment if the fiber is unmated or unterminated.
 - Do not stare into an unmated fiber or at any mirror-like surface that could reflect light emitted from an unterminated fiber.
 - Do not view an activated fiber with optical instruments (e.g., eye loupes, magnifiers, microscopes).
 - Use safety-approved optical fiber cable to maintain compliance with applicable laser safety requirements.

Warning: Fiber Optic Cables



WARNING:

Avoid personal injury! Qualified service personnel may only perform the procedures in this manual. Wear safety glasses and use extreme caution when handling fiber optic cables, particularly during splicing or terminating operations. The thin glass fiber core at the center of the cable is fragile when exposed by the removal of cladding and buffer material. It easily fragments into glass splinters. Using tweezers, place splinters immediately in a sealed waste container and dispose of them safely in accordance with local regulations.

Safe Operation for Software Controlling Optical Transmission Equipment

If this manual discusses software, the software described is used to monitor and/or control ours and other vendors' electrical and optical equipment designed to transmit video, voice, or data signals. Certain safety precautions must be observed when operating equipment of this nature.

For equipment specific safety requirements, refer to the appropriate section of the equipment documentation.

For safe operation of this software, refer to the following warnings.



WARNING:

- **Ensure that all optical connections are complete or terminated before using this equipment to remotely control a laser device. An optical or laser device can pose a hazard to remotely located personnel when operated without their knowledge.**
- **Allow only personnel trained in laser safety to operate this software. Otherwise, injuries to personnel may occur.**
- **Restrict access of this software to authorized personnel only.**
- **Install this software in equipment that is located in a restricted access area.**

Laser Power and Warning Labels

Warning Labels

The following labels are located on this product.

Laser Warning Label *



Laser Classification Label



* Located on host module (part number 4008281) only.

Product and Laser Information Label

Part Number: 4008427
Model: P2-HD-13TXF-10-SA
Manufactured: April, 2005
Manufacturing Site: 45661
Assembled in: USA

This device complies with part 15 of the FCC rules. Operation is subject to the following two conditions: (1) This device may not cause harmful interference, and (2) This device must accept any interference received, including interference that may cause undesired operation.

<p>INVISIBLE LASER RADIATION DO NOT VIEW DIRECTLY WITH OPTICAL INSTRUMENTS. CLASS 1M LASER PRODUCT PER IEC 60825-1 EDITION 1.2 2001 50mW MAXIMUM OUTPUT AT 1310 nm</p>	<p>ATTENTION Observe precautions for handling electrostatic sensitive devices.</p> 
--	---

This product complies with 21 CFR 1040.10 except for deviations pursuant to Laser Notice No. 50 dated July 26, 2001

TP203

Location of Labels on Equipment

The following illustrations display the location of warning labels on this equipment.

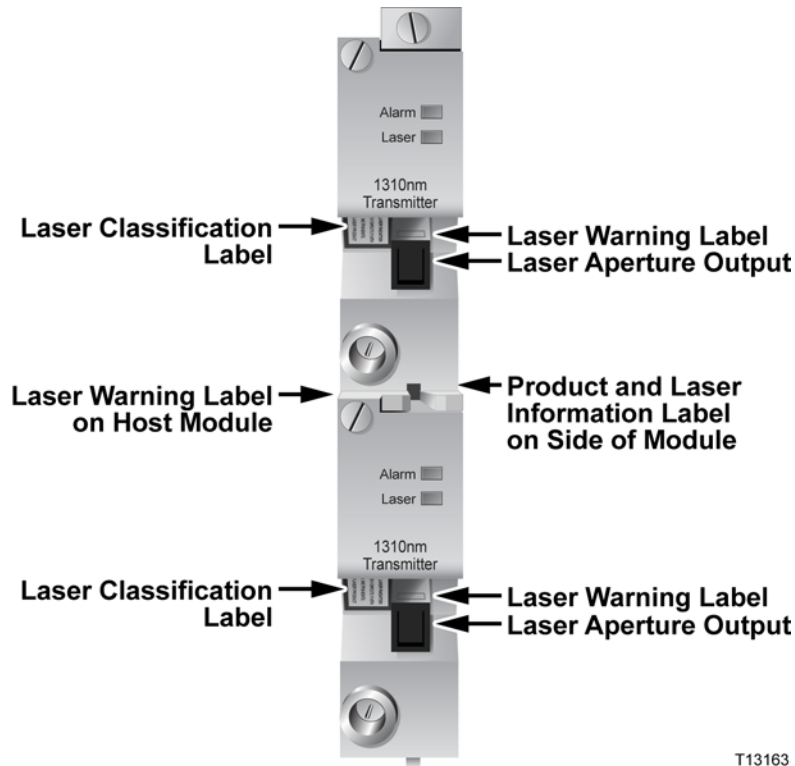

1

Module Introduction

Overview

This chapter describes the Prisma II™ High Density Transmitter module.

Purpose

This guide provides information about the high density transmitter. This chapter describes the front and back panels, and presents a setup summary for the high density transmitter.

Who Should Use This Document

This document is intended for authorized service personnel who have experience working with similar equipment. The service personnel should have appropriate background and knowledge to complete the procedures described in this document.

Qualified Personnel

Only appropriately qualified and skilled personnel should attempt to install, operate, maintain, and service this product.



WARNING:

Only appropriately qualified and skilled personnel should attempt to install, operate, maintain, and service this product. Otherwise, personal injury or equipment damage may occur.

Scope

This guide discusses the following topics.

- Description of Prisma II High Density Transmitter
- Installation procedures
- Operation using the ICIM
- Operation using LCI
- Maintenance and troubleshooting

Document Version

This is the fifth release of this guide.

In This Chapter

- High Density Transmitter Description 3
- High Density Transmitter Front and Back Panel 5
- Host Module 7
- Module Configuration 9

High Density Transmitter Description

Prisma II High Density Transmitters are plug-in modules for the Prisma II and Prisma II XD platforms. These modules are part of the Prisma II optical network, an advanced transmission system designed to optimize network architectures and increase reliability, scalability, and cost effectiveness.

The transmitter module installs into a Prisma II XD Chassis directly, or into a standard Prisma II Chassis by means of a host module that accepts up to two Prisma II High Density application modules.

The transmitter is designed to operate over a wide range of optical output powers and loss budgets, delivering both analog and digital signals. Microprocessor control allows for ease of installation and flexibility of application.

High Density Transmitter Features

The high density transmitter has the following features.

- Front panel green light emitting diode (LED) to indicate operating status
- Front panel red LED to indicate alarm status
- -20 dB front panel test point
- Optical input connectors
- Plug-and-play capability
- Compatible with Cisco's Intelligent Communications Interface Module (ICIM), Local Craft Interface (LCI) software, and Transmission Network Control System (TNCS) software
- Blind-mate radio frequency (RF) connections

High Density Transmitter Operation

The Prisma II High Density Transmitter receives an RF signal through a connector on the back of the module. The RF input signal is amplified before being converted to an optical signal using a high-performance, isolated distributed feedback (DFB) laser.

The incoming RF signal is also routed through a coupler to an RF detector circuit. The RF detector produces a DC voltage proportional to incident RF power that is used to monitor the input power level. The transmitter generates an alarm condition if input power rises above or falls below a specified level.

Transmitter gain is controlled through the selection of Manual or Automatic Gain Control (AGC) mode operation.

- In Manual mode, an attenuator can be used to reduce RF power in an overdrive condition or to compensate for variations in transmitter gain. Any manual attenuator adjustments are reflected in the indicated RF drive level. It may be desirable to make such adjustments to compensate for power differences if the channel load differs from the specified value.
- In AGC mode, the microprocessor monitors the actual input composite power and adjusts the attenuator to maintain constant RF drive level into the laser diode.

After the RF amplification and control stage, the signal is equalized and impedance-matched, and then is sent to the laser. The optical output connector is located on the front panel of the module.

The user can turn the laser on or off, adjust the drive level to the laser, and set alarm levels. The module can be controlled either locally using an ICIM front-panel interface, or remotely using LCI or TNCS software, CLI commands, or the ICIM Web Interface.

High Density Transmitter Optical Output

Depending on how you ordered your system, the optical output connectors may be either SC/APC, SC/UPC, or E2000/APC.

Laser Warning



WARNING:

Avoid damage to your eyes! Do not look into any optical connector while the system is active. Even if the unit is off, there may still be hazardous optical levels present.

High Density Transmitter Block Diagram

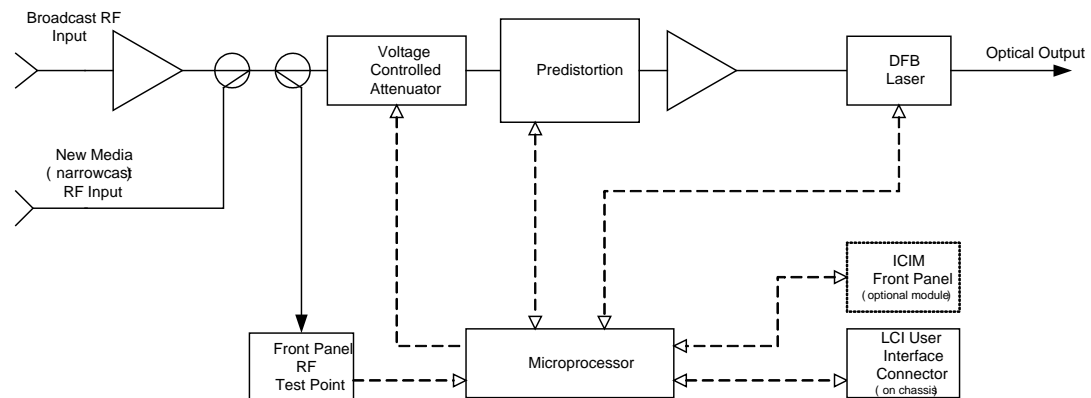

TP202

High Density Transmitter Front and Back Panel

High Density Transmitter Illustration

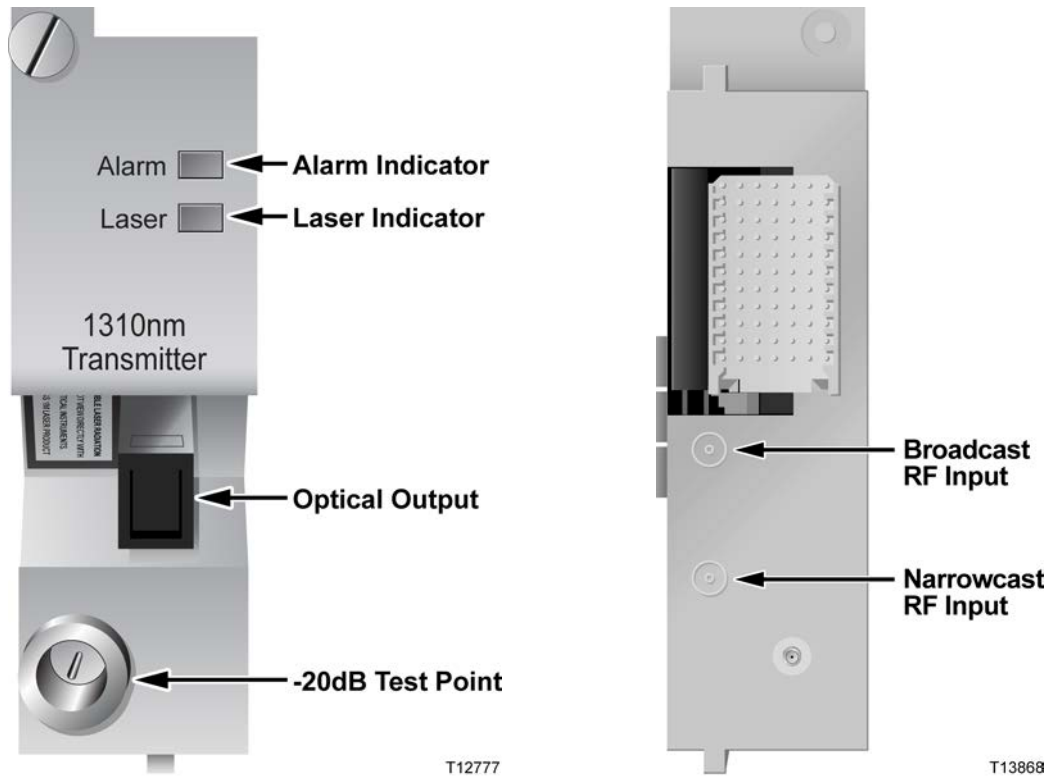

High Density Transmitter Front Panel Features

Part	Function
Alarm Indicator	Illuminates or blinks when an alarm condition occurs.
Laser Indicator	Illuminates when laser is active.
Optical Output	Connects the output signal to the optical cable.
-20 dB Test Point	Provides a -20 dB sample of the RF output signal.

Back Panel Connectors

Blind-mate connectors make it easy to install this module. The push-on connector on the back of the module mates with the back plane bus connector inside the chassis. This 55-pin connector and the two RF connectors provide the following facilities.

- RF signal connection
- Electrical power input connection
- Alarm communications connections
- Status-monitoring communications
- Communications and control connections

The ESD guide pin near the bottom of the back panel serves as both a guide pin and an ESD ground connection. The length of the pin ensures that ground is the first electrical connection made as the module is inserted, and the last connection to be broken as the module is removed.

Host Module

A host module is required to mount the application module in a standard Prisma II Chassis. The host module doubles the density of the Prisma II Chassis by providing two high density module slots for each current Prisma II slot. Its simple design allows for efficient routing of RF and electrical signal between the chassis back plane and each high density module.

Host Module Features

The host module has the following features:

- Provides upper and lower slots for two high density modules
- Incorporates a passive design for high reliability
- Provides for RF and DC routing between the chassis back plane and each high density module

Host Module Illustration

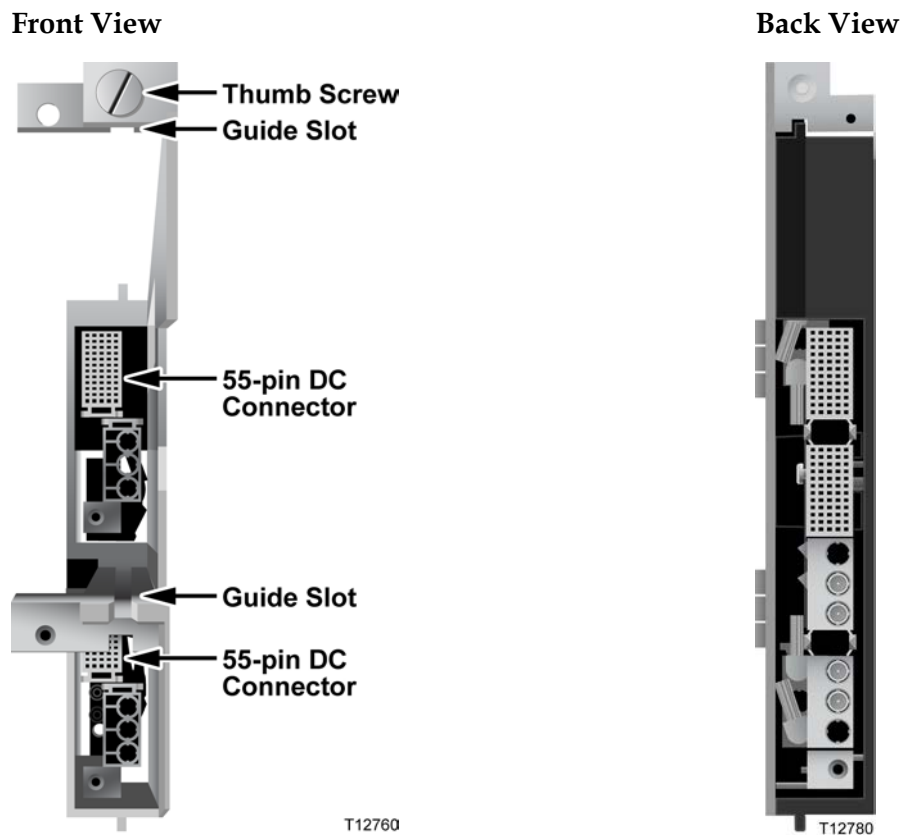

Module Configuration

The module is shipped from the factory with operational parameters set to factory defaults. However, you will probably choose to configure the operating parameters so that they are best suited for your application.

Configuration and Monitoring Methods

The module may be controlled and monitored using any of the following methods.

- Prisma II ICIM Front Panel

When a standard Intelligent Communications Interface Module 2 (ICIM2) is used, its front-panel LCD and keypad interface can be used to configure and monitor this and other Prisma II modules in the ICIM domain. For instructions on operating this module using this ICIM, refer to *Operation using ICIM* (on page 35).

- LCI software

Local Craft Interface (LCI) software running on a locally connected PC may be used to configure operating parameters of Prisma II modules. For instructions on operating this module using LCI software, refer to *Operation using LCI* (on page 73).

- TNCS software

If an ICIM2 or ICIM2-XD is installed, TNCS software may be used to configure and monitor all Prisma II modules in the ICIM domain. For instructions on operating this module using TNCS, refer to the *TNCS Administrator Release 3.0 Software User's Guide*, part number 4013494.

- CLI Commands

If an ICIM2 or ICIM2-XD is installed, command line interface (CLI) commands enable communication between the ICIM and the operator over Telnet to allow for remote module setup and monitoring. For details, see the *Prisma II Platform Remote User Interface Guide, System Release 2.03*, part number 4025477.

- ICIM Web Interface

The ICIM Web Interface offers a user-friendly alternative to CLI commands for remote module setup and monitoring using an ICIM2 or ICIM2-XD. Users navigate a series of HTML pages through a standard web browser to view and, where permitted, adjust module parameters. For additional information, see the *Prisma II Platform Remote User Interface Guide, System Release 2.03*, part number 4025477.

Configuration Summary

You can use any of the methods listed above to perform the following configuration tasks:

- Enable or disable transmitter operation
- Enable or disable the “RF input low” alarm
- Configure the module as master or slave
- Set the relative RF drive level into the transmitter
- Return to the factory default settings (except LCI)
- Turns automatic gain control (AGC) on or off

For detailed information on configuring this module, refer to *Operation using ICIM* (on page 35) or *Operation using LCI* (on page 73).

2

Module Installation

Introduction

This chapter contains instructions for installing the module and describes the site requirements, equipment, and tools needed for module installation.

In This Chapter

■ Preparing for Installation.....	12
■ Site Requirements	13
■ Connecting the RF Cables to the Chassis	17
■ Installing the Module in the Chassis.....	19
■ Connecting Optical Cables	23
■ Connecting the ICIM to Additional Chassis	27
■ Connecting a Chassis to the TNCS Server.....	29
■ External Alarms Connections	31

Preparing for Installation

Before you begin, make sure that the module is in good condition and that you have the tools and equipment listed here.

Equipment and Tools Needed

Before you begin, make sure that the module is in good condition. You need the following equipment and tools to install these modules.

You need . . .	To . . .
a Prisma II or Prisma II XD Chassis with power supply	provide housing, power, and input/output connections to the module.
3/8-in. flat-blade screwdriver	secure the module in the chassis.
optical cables with connectors	carry optical input and output signals.
optical cleaning materials	clean optical connectors.
optical power meter	verify optical input and output levels.
spectrum analyzer (for transmitter)	verify proper RF input.

Unpacking and Inspecting the Module

As you unpack the module, inspect it for shipping damage. If you find any damage, contact Cisco Services.

Site Requirements

Before you begin, make certain that your installation site meets the requirements discussed in this section.

Access Requirements

Ensure that only authorized personnel have access to this equipment. Otherwise, personal injury or equipment damage may occur.



WARNING:

Use this product in locations that restrict access to all persons who are not authorized. Otherwise, personal injury or equipment damage may occur.

Equipment Rack

To install this module, your site must be equipped with an Electronics Industry Association (EIA) equipment rack that properly houses the chassis with proper spacing for air circulation. For instructions on installing the chassis in the rack, refer to the guide that was shipped with the chassis.

Operating Environment



CAUTION:

Avoid damage to this product! Operating this product outside the specified operating temperature limits voids the warranty.

Follow these recommendations to maintain an acceptable operating temperature of the equipment.

- Temperature at the air inlet must be between -40°C and 65°C (-40°F and 149°F).
- Keep cooling vents clear and free of obstructions.
- Provide ventilation as needed using air-deflecting baffles, forced-air ventilation, or air outlets above enclosures, either alone or in combination.

Power Requirements

All Prisma II application modules receive their electrical power from the chassis. The modules may be installed with the chassis under power.

Space Requirements

This is a single-width, half-height module.

Prisma II Chassis Installation

When installed in a standard Prisma II Chassis, the module is placed in a host module and then inserted into the chassis in slots 5 through 16.

- If the module occupies the upper host module position, its slot number is the same (5 through 16) as that of the host module.
- If the module occupies the lower host module position, its slot number is 16 plus the host module slot number, or 21 through 32.

Slots 1 through 4 are usually reserved for the power supplies. If an ICIM is installed, it occupies slots 15 and 16. If an ICIM is not installed, any other module (or host module) can occupy these slots. Slots 2 and 4 are reserved for an internal power supply, if installed. If an internal power supply is not installed here, any other module (or host module) can occupy these slots.

Prisma II XD Chassis Installation

When installed in a Prisma II XD Chassis, the module is inserted directly into an available application module slot on the chassis front panel. The application module slots are numbered 1 through 16. The chassis power supplies and ICIM are installed in dedicated slots on the chassis back panel, so slots 1 through 16 are available for application modules no matter how the chassis is configured.

Prisma II Chassis Style

The standard Prisma II chassis may be configured as front-access or rear-access depending on the system you have purchased. Power, RF input or output, and other connectors may be located on either the front or rear of the chassis. Connections to the chassis serve the same function and are made in the same manner regardless of the location of the connectors or chassis configuration.

Rear-Access Chassis - Front Panel Illustration

The following illustration shows the front of the rear-access Prisma II Chassis with two power supplies, 10 full-height modules, and the ICIM installed.

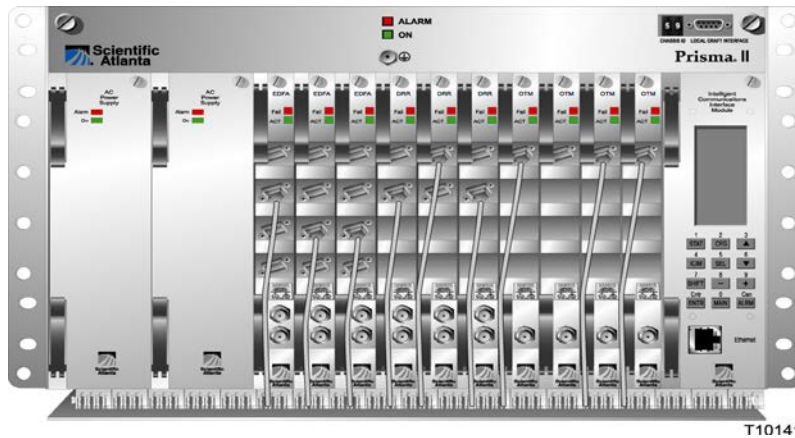

Front-Access Chassis - Front Panel Illustration

The following illustration shows the front of the front-access chassis with two power supplies, 10 full-height modules, and the ICIM installed.

The power inlets, RF input/output, and RF ports are located on the recessed bottom of the connector interface panel on the front-access version of the chassis.

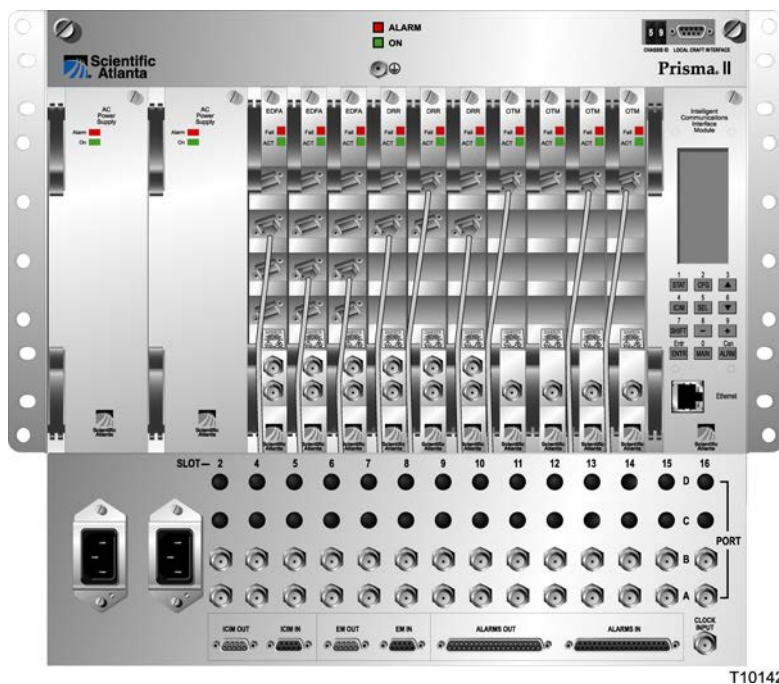

Prisma II XD Chassis Style

The Prisma II XD chassis back panel serves as both a connector panel and a receptacle for AC power supply modules and the ICIM2-XD, when installed.

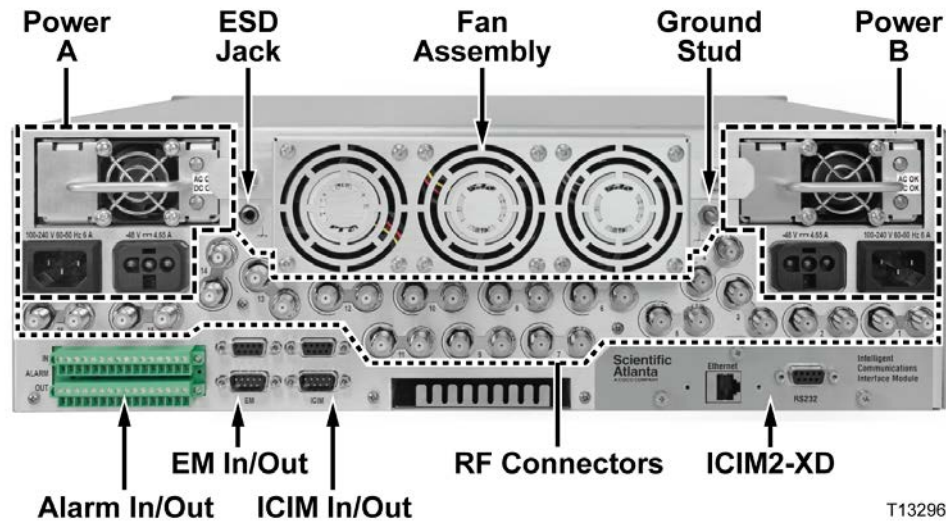

The RF connectors are arranged in numbered pairs to identify the corresponding application module slot. One connector in each pair has a black retaining nut and a black circle in the panel artwork to mark it as belonging to the upper connector on the chassis midplane.

Connecting the RF Cables to the Chassis

To Connect RF Cables for Each Module

Complete the appropriate procedure below to connect RF cables for the module.

Note: These procedures assume that the chassis is mounted in a rack.

Standard Prisma II Chassis

- 1 Attach a 75-ohm RF cable to the appropriate RF source.
- 2 At the front/rear of the chassis, locate the RF ports.

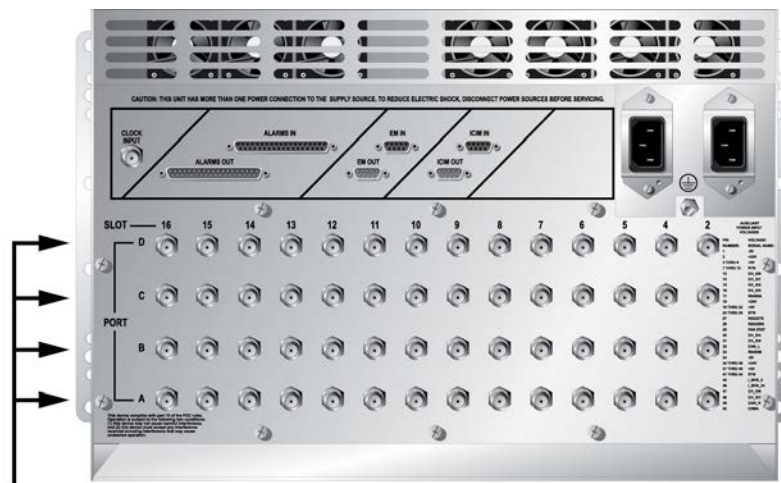

RF Ports

T12770

Note: RF ports are located on the front of the front access chassis.

- 3 Attach the other end of the RF cable to Port A connector (RF IN) of the corresponding slot where the module is to be installed. This is the RF input connection.

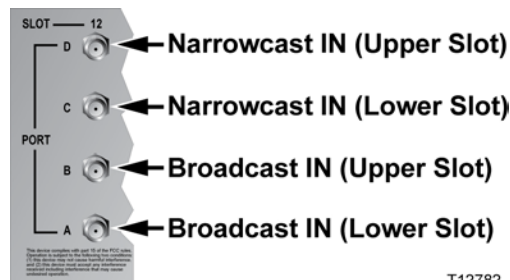

T12782

- 4 If F-connectors are installed, use a 7/16-in. open-end wrench to secure both cables to the connectors at the chassis.

Prisma II XD Chassis

- 1 Attach a 75-ohm RF cable to the appropriate RF source.
- 2 Locate the RF ports at the back of the chassis.

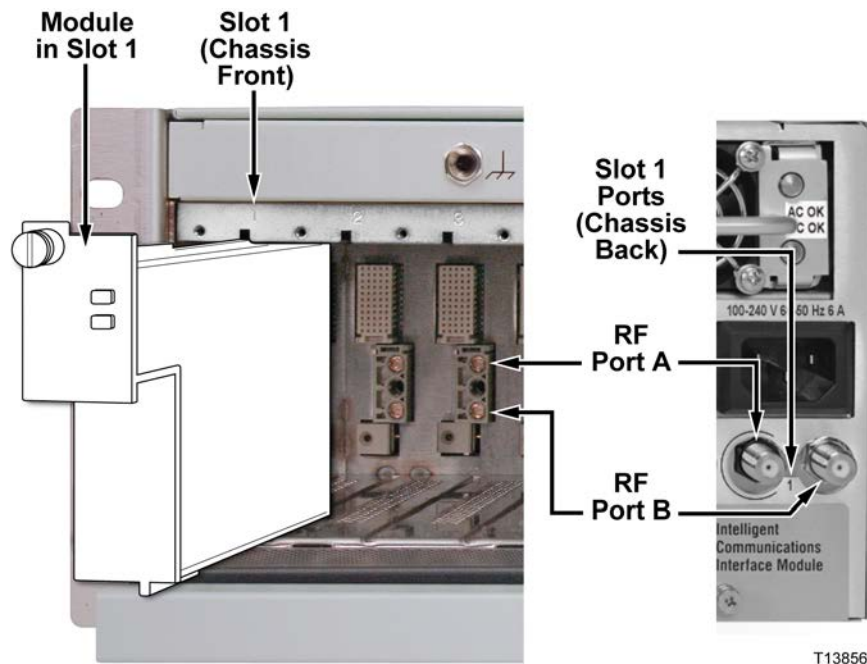

- 3 Attach the other end of the RF cable to Port A connector (RF IN) of the corresponding slot where the module is to be installed. This is the RF input connection.
- 4 If F-connectors are installed, use a 7/16-in. open-end wrench to secure both cables to the connectors at the chassis.

Installing the Module in the Chassis

To Install the Transmitter Modules in the Host Module

Note: All Prisma II high-density application modules must be installed in a host module before they can be mounted in a standard Prisma II Chassis.

Complete the following steps to install the application modules in the host module.

- 1 Align the ridges on the top and bottom of the module with the guide slots located on the host module and the chassis. Be careful to keep the module level as you slide it into the host to avoid bending the pins on the host back plane.
- 2 Gently slide the module into the host module until you feel the power and communications connections on the back of the module join connectors on the host module. Use the thumbscrew on the top of the module to lock it in place.

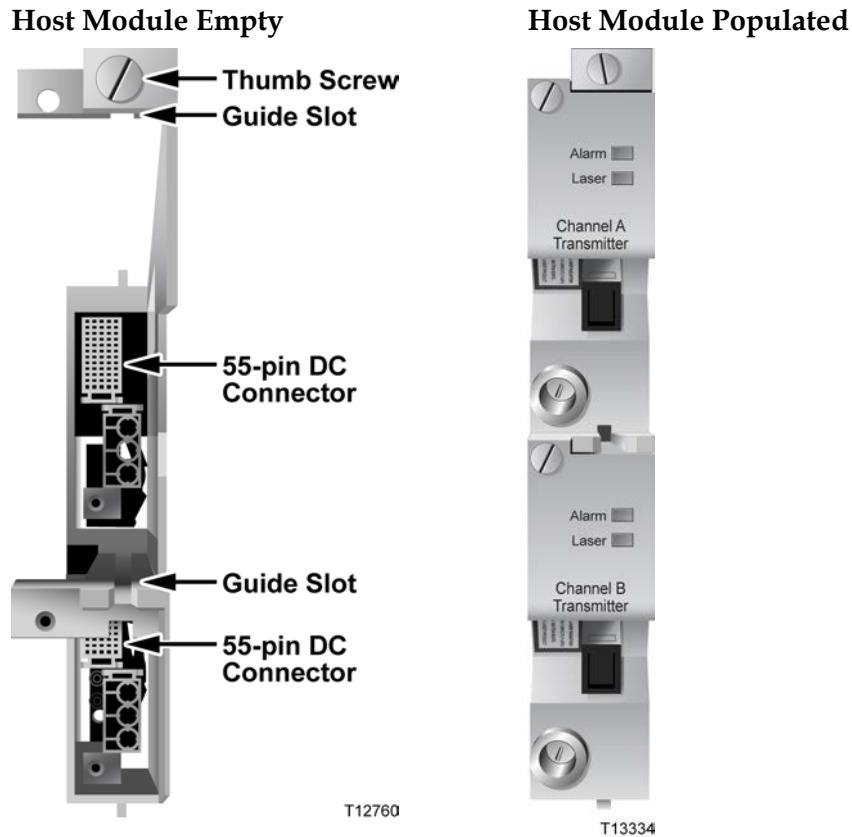

To Install the Host Module in the Chassis

Note: This procedure assumes that the chassis is mounted in a rack.

- 1 Locate the fiber guides at the bottom of the chassis and the module guide slots inside the chassis as shown in the following illustration.

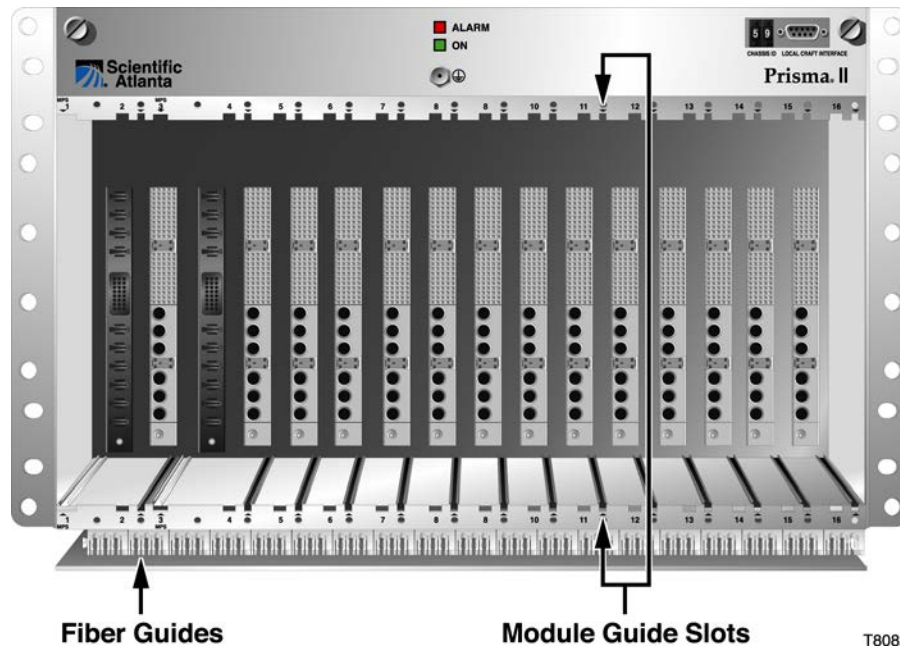

- 2 Align the ridges on the top and bottom of the host module with the guide slots on the chassis. Be careful to keep the host module level as you slide it into the chassis to avoid bending the pins on the back plane bus.
- 3 Gently slide the host module into the chassis until you feel the connections on the back of the host module join connectors on the back plane bus.

Note: Do not force or bang the host module into the chassis. If properly aligned, the host module should slide in with minimal force.

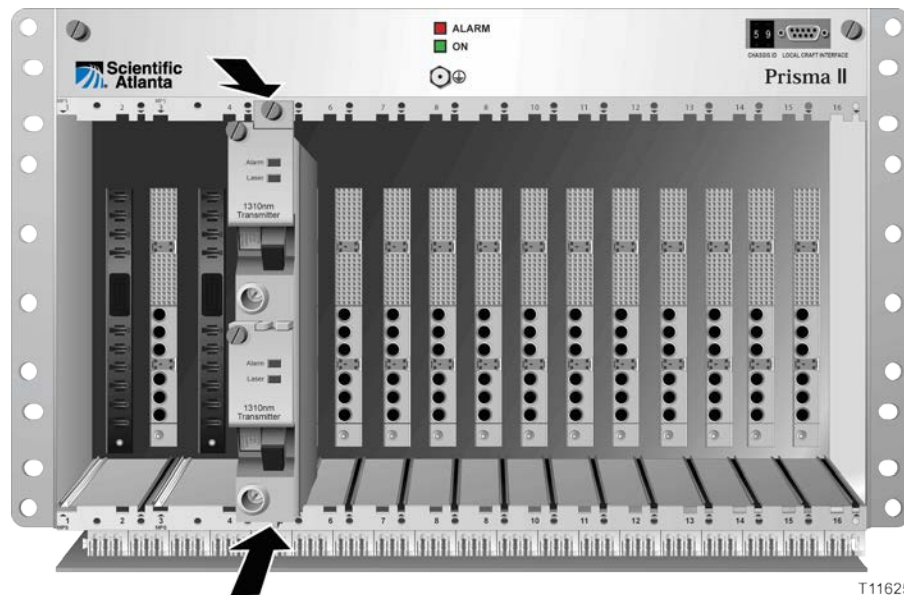

- 4 Hand-tighten the screw at the top of the host module to ensure that the first few threads engage smoothly. Use a 3/8-in. flat-blade screwdriver to secure the mounting screw. **Do not over-tighten.**

To Install the Module in a Prisma II XD Chassis

Note: This procedure assumes that the chassis is installed in a rack.



WARNING:

Avoid damage to your eyes! Do not look into any optical connector while the system is active. Even if the unit is off, there may still be hazardous optical levels present.

Complete the following steps to install the module in the chassis.



CAUTION:

Always use a screwdriver to loosen or tighten the screws holding the application modules, ICIM2-XD, fan assembly, power supply modules, DC-to-DC converters, or blanking panels in place. Do not attempt to loosen or tighten these screws solely by hand.

- 1 Locate the fiber guides at the bottom of the chassis and the module guide slots inside the chassis as shown in the following illustration.

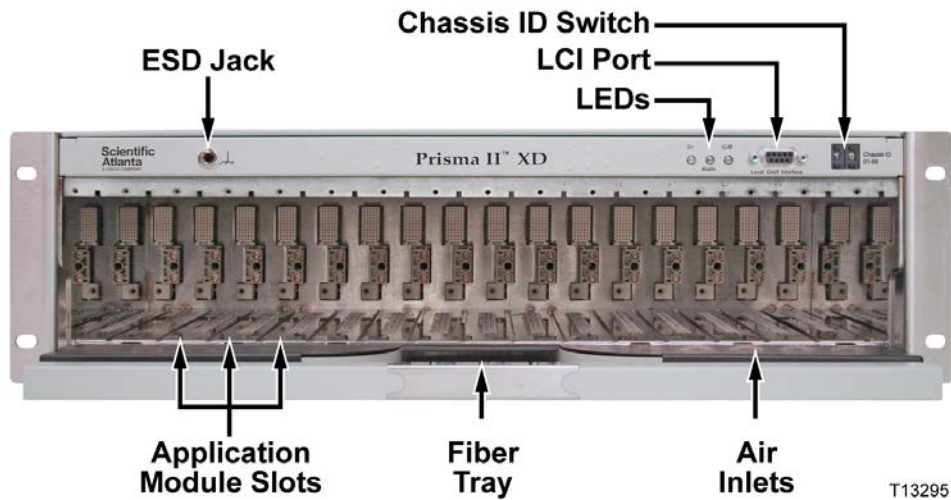

- 2 Align the ridges on the top and bottom of the module with the module guide slots located on the chassis.
- 3 Gently slide the module into the chassis until its power and communications connections join connectors on the midplane bus. *Do not force the module into the chassis.* If properly aligned, it should slide in with minimal force.

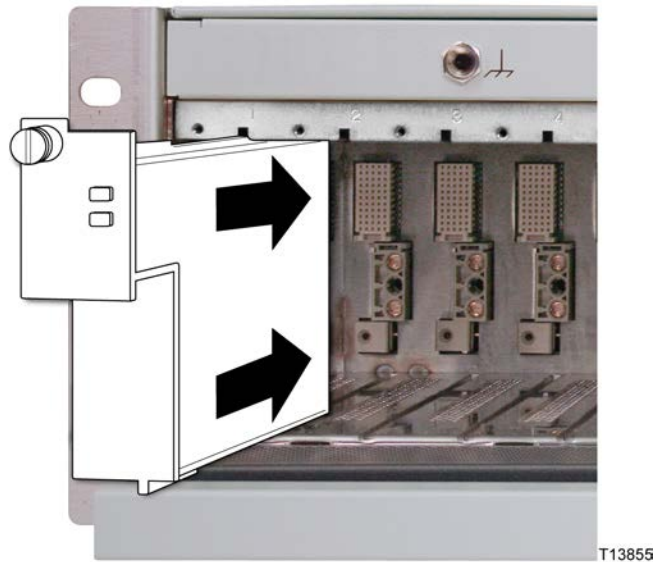

- 4 Tighten the screw at the top of the module to secure it in the chassis. Use a 3/8-in. flat-blade screwdriver to secure. *Do not over-tighten.*
- 5 Fill any unused chassis slots with module blanks to help ensure proper cooling air flow.

Connecting Optical Cables

Fiber Fish Tool



WARNING:

Unterminated fiber cables and connectors may emit invisible laser radiation. Avoid direct exposure to the laser light source. Ensure that the fiber cable is terminated before "fishing."

The Fiber Fish tool that was shipped with the Prisma II Chassis is used to pull an optical cable from the rear of the chassis to the front of the chassis so the optical cables can be connected to optical connectors on the front panel of modules.



Fiber Fish Tool Hook

At the end of the Fiber Fish tool is a small hook that allows you to hold an optical cable so that you can pull it through to the front panel of chassis.



To Pull the Optical Cable to the Module

- 1 Insert the Fiber Fish tool through the slot located just above the bottom of the chassis.
- 2 At the rear of the chassis, locate the appropriate optical cable.
- 3 Insert the optical cable into notched area of the Fiber Fish tool as shown below.

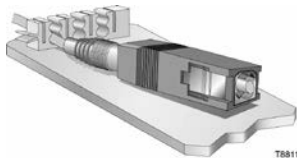

- 4 At the front of the chassis, pull the Fiber Fish tool (with cable attached) to the front of the chassis.
- 5 Disengage the optical cable from the Fiber Fish tool and attach to the appropriate connector on desired module.

Optical Connector Cleaning Overview

Cleaning fiber-optic connectors can help prevent interconnect problems and therefore aid system performance. When optical connectors are disconnected and reconnected, the fiber surface can become dirty or scratched. The goal of cleaning the fiber optic connectors is to remove all dust and contaminants without leaving any residue.

Recommended Equipment

The following equipment is recommended to clean the ends of fiber-optic connectors.

- CLETOP or OPTIPOP ferrule cleaner (CLETOP Type A for SC, Type B for LC)
- Compressed air (also called “canned air”)
- Lint-free wipes moistened with optical-grade (99%) isopropyl alcohol
- Bulkhead swabs for LC or SC type connectors (choose appropriate type)
- Optical connector scope

Tips for Optimal Fiber-Optic Connector Performance

Follow these guidelines to ensure optimal connector performance.

- Do not connect or disconnect optical connectors while optical power is present.
- Always use compressed air before cleaning the fiber-optic connectors.
- Always use end caps on connectors when they are not in use.
- Always use compressed air to clean the end caps.
- If you have any degraded signal problems, clean the fiber-optic connector.
- Advance a clean portion of the ferrule cleaner reel for each cleaning.
- Turn off optical power before making or breaking optical connections in order to avoid microscopic damage to fiber mating surfaces.

To Clean Optical Connectors



Warning:

- **Avoid personal injury! Use of controls, adjustments, or procedures other than those specified herein may result in hazardous radiation exposure.**
- **Avoid personal injury! The laser light source on this equipment (if a transmitter) or the fiber cables connected to this equipment emit invisible laser radiation.**
- **Avoid personal injury! Viewing the laser output (if a transmitter) or fiber cable with optical instruments (such as eye loupes, magnifiers, or microscopes) may pose an eye hazard.**

- Do not apply power to this equipment if the fiber is unmated or unterminated.
- Do not stare into an unmated fiber or at any mirror-like surface that could reflect light emitted from an unterminated fiber.
- Do not view an activated fiber with optical instruments (e.g., loupes, magnifiers, microscopes).
- Use safety-approved optical fiber cable to maintain compliance with applicable laser safety requirements.

Important: Ensure that no optical power is present prior to this procedure.

- 1 Turn optical power off to the connector.
- 2 Using an optical connector scope, inspect the connector for scratches, burns, or other signs of damage.

Note: If the connector is damaged, replace the jumper.

- 3 If the connector requires cleaning, swipe it across the face of the appropriate ferrule cleaner several times.

Result: This will remove dust and some films.

Note: You may hear a slight "squeak" while cleaning the connector, indicating that it is clean.

- 4 Inspect the connector again. If the connector requires further cleaning, clean it using 99% isopropyl alcohol and a lint free wipe.
- 5 Swipe the connector across the face of the appropriate ferrule cleaner several more times to remove any film left by the alcohol.
- 6 Repeat all the steps above as needed until the connector is clean.

To Connect Optical Cables to Module

Note: This procedure assumes that the chassis is mounted in a rack.

Important: Observe laser safety precautions. Refer to the **Laser Safety** information earlier in this guide.

Complete the following steps for each optical cable to be connected to the module.

- 1 Attach one end of the optical cable to the optical output connector located on the front of the module.

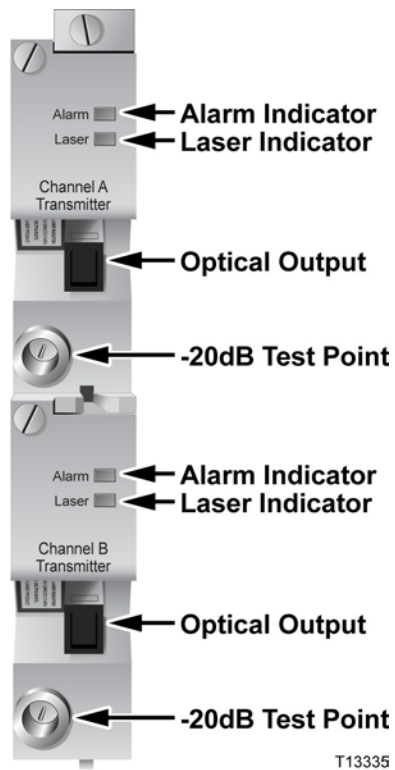

- 2 Route the other end of the optical cable to the appropriate destination.

Connecting the ICIM to Additional Chassis

Chassis-to-Chassis ICIM Connections

The Prisma II platform allows the ICIM to be located in one chassis and control modules located in several other chassis. This communication “daisy-chain” can be enabled by connecting cables to the **ICIM IN** and **ICIM OUT** connectors located on the connector interface panel of the chassis. This connection is required if an ICIM in one chassis is to communicate with or control any module located in a separate chassis.

Note: An ICIM can control a maximum of 140 modules. Depending on your application, this is typically 6 or 7 chassis to a rack. Do not exceed these limits.

ICIM IN and ICIM OUT Connectors

Every Prisma II Standard and II XD Chassis has a DB9 **ICIM IN** and a DB9 **ICIM OUT** connector for the purpose of chassis-to-chassis ICIM connections. **ICIM IN** is a female connector and **ICIM OUT** is a male connector.

Standard Prisma II Chassis



Prisma II XD Chassis

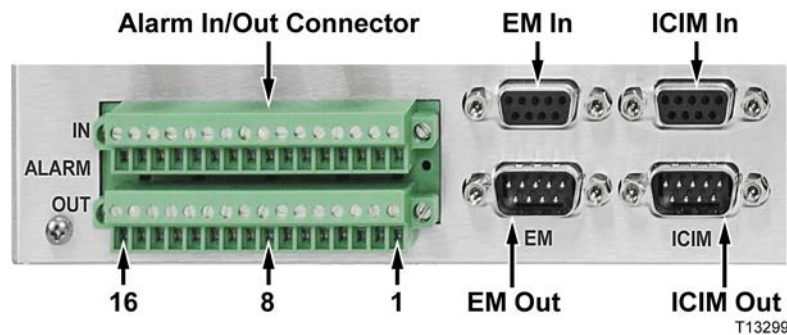

ICIM IN and ICIM OUT Cables

The cable required for both **ICIM IN** and **ICIM OUT** connections is a shielded 9-wire serial extension cable, DB9 Female to DB9 Male. This cable can be purchased locally or from the factory. The chassis data sheet lists the part number for a 6-foot DB9 Female to DB9 Male serial extension cable. The connectors are a serial 9-pin D-shell (EIA 574/232).

To Connect Chassis-to-Chassis ICIM IN and ICIM OUT Ports

- 1 Connect the serial extension cable from the **ICIM OUT** of the chassis containing the ICIM to the **ICIM IN** connector of the second chassis.
- 2 Connect a serial extension cable from the **ICIM OUT** of the second chassis to the **ICIM IN** of the third chassis.
- 3 Continue this “daisy-chain” connection until all chassis are connected.
- 4 Connect an ICIM OUT terminator, part number 4013014, to the ICIM OUT connector on the last chassis in the daisy-chain connection. The ICIM OUT terminator ships with the ICIM.

Important:

- All chassis connected in the daisy-chain must be powered and have a fan tray installed. A chassis connected in the daisy-chain that is not powered or has no fan tray installed will cause faulty operation of the ICIM.
- All chassis connected in this daisy-chain must have a unique chassis ID number.
- If the ICIM OUT terminator that ships with the ICIM is not installed on the last chassis of a daisy-chain connection, faulty communication with the ICIM may occur.

Connecting a Chassis to the TNCS Server

Cable Kits for Connecting a Chassis to the TNCS Server

Connecting the chassis to the TNCS server requires two special cable kits that are available from the factory.

- The RS-485 cable kit, part number 735748, includes the following:
 - Breakout boxes, 4 each
 - RS-485 cable assemblies (50 feet), 4 each
 - Breakout box mounting brackets, 4 each
 - 6-32 screws (1.25 inches), 100 each
- The Prisma II cable kit, part number 738686, includes the following:
 - Prisma II cable assemblies, 4 each

The RS-485 cable kit is used to communicate with the RS-485/422/TTL devices.

To Connect TNCS to the Chassis EM IN Port

- 1 Mount one of the breakout boxes (included in the RS-485 cable kit) in a rack location central to the appropriate Prisma II Chassis.



- 2 Connect a RS-485 cable assembly (included in the RS-485 cable kit) from the breakout box to the **RS-485 COM** port on the TNCS server.
- 3 Connect one Prisma II cable assembly (included in the Prisma II cable kit) from the breakout box to the **EM IN** port of each Prisma II Chassis containing an ICIM.



Note: As a general rule, it is recommended that the total number of ICIMs connected to any single COM port on the TNCS server be limited to four (4). However, you may connect more than four ICIMs per TNCS COM port as long as the total number of devices (modules) monitored by a single COM port does not exceed four-hundred (400) *and* the total number of devices monitored by any single ICIM does not exceed 140.

Using TNCS with Multiple Chassis

All chassis within an ICIM domain are connected in series via the ICIM IN/ICIM OUT connectors using standard 9-wire serial extension cable, DB9 Female to DB9 Male. Using the EM IN/EM OUT connectors, a chassis with an ICIM installed is connected to a breakout box as shown below.

The breakout box is connected to the TNCS server with the cable included in the RS-485 cable kit.

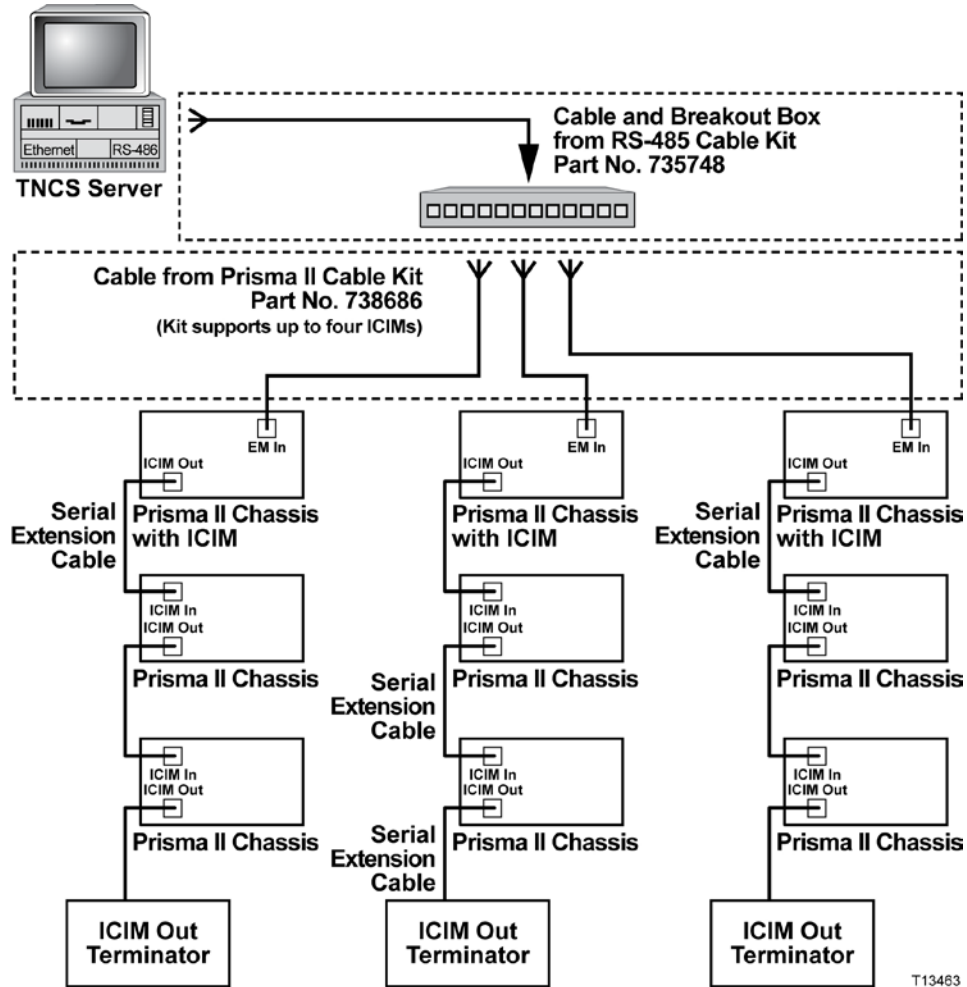

External Alarms Connections

Master/Slave Operation

All Prisma II modules ship from the factory configured as a master. The LCI, TNCS software, or the ICIM can be used to reconfigure a module as a slave or as redundant. The Prisma II Chassis allows for local hard-wired redundancy by using the **ALARM IN** and **ALARM OUT** connectors located on the connector interface panel. A pair of modules can be configured so that if the master fails, the slave takes over by using the **ALARM IN** and **ALARM OUT** connectors.

ALARMS IN and ALARMS OUT Connectors

Every Prisma II Standard and II XD chassis provides connectors for external alarms to and from each module slot. These alarm connectors are located on the chassis connector panel and are labeled **ALARMS IN** and **ALARMS OUT**.

For detailed information on **ALARM IN** and **ALARM OUT** connectors, see the *Prisma II Chassis Installation and Operation Guide*, part number 713375 or the *Prisma II™ XD Platform System Guide*, part number 4021339.

When a critical alarm occurs in a Master module, the Master turns off and the Slave (redundant module) is enabled. To make this happen, the pin representing the Master module slot in the **ALARM OUT** connector must be externally wired to the pin representing the Slave module slot in the **ALARM IN** connector. After wiring these contacts, take care to ensure that the Master and Slave modules are not moved to other slots. Otherwise, the **ALARM IN** and **ALARM OUT** connectors will need to be rewired to the appropriate pins.

Note:

- Any device configured as Single or Master ignores its **ALARM IN** contacts.
- To verify proper wiring and redundant configuration, simply unplug the Master module and observe that the Slave module turns on.

ALARMS IN and ALARMS OUT Connector Illustration

Standard Prisma II Chassis

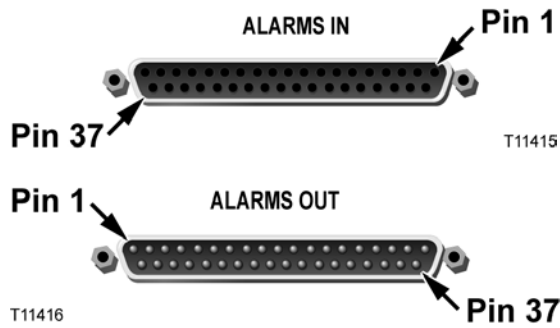

Prisma II XD Chassis

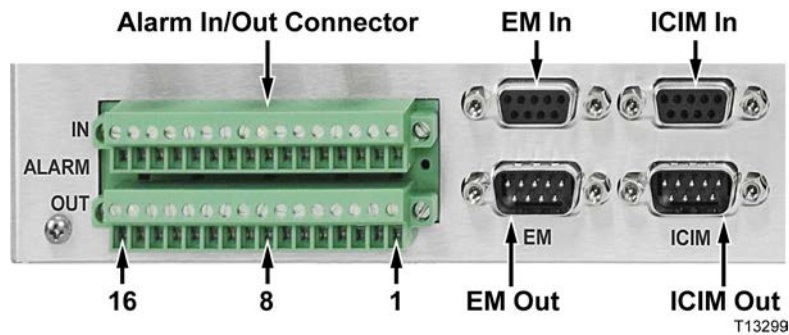

Master/Slave Illustration

Inter-module connections are made on the back of the chassis using "ALARMS IN" and "ALARMS OUT" connectors.

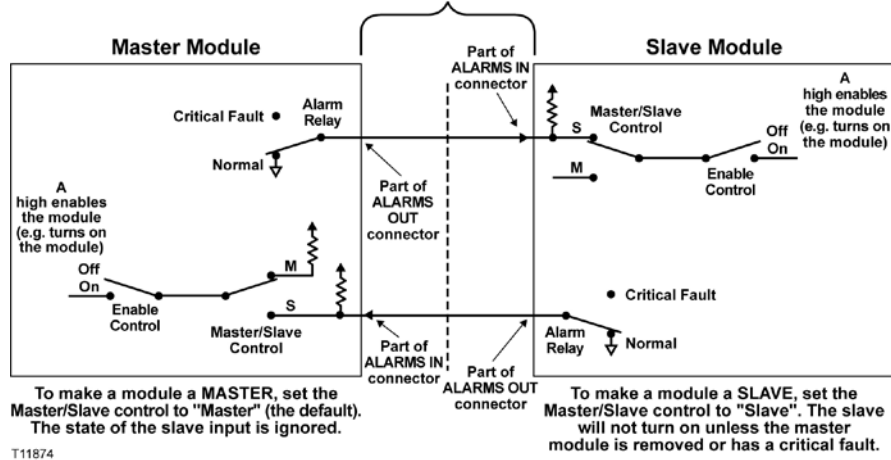

Redundancy Interface Panel

The Prisma II Redundancy Interface Panel is an accessory to the Prisma II platform. It is intended to be used with the master/slave feature and the contact closure alarm feature of the Prisma II platform.

The Prisma II Redundancy Interface Panel serves as an extension to the two DB-37 connectors labeled **ALARM IN** and **ALARM OUT** on the connector interface panel of the chassis. The terminals on the redundancy interface panel are extensions of pins on the **ALARMS OUT** and **ALARMS IN** connectors on the chassis.

For additional information, see the *Prisma II Chassis Installation and Operation Guide*, part number 713375.

Prisma II Redundancy Interface Panel Illustrations

Front Panel



Back Panel

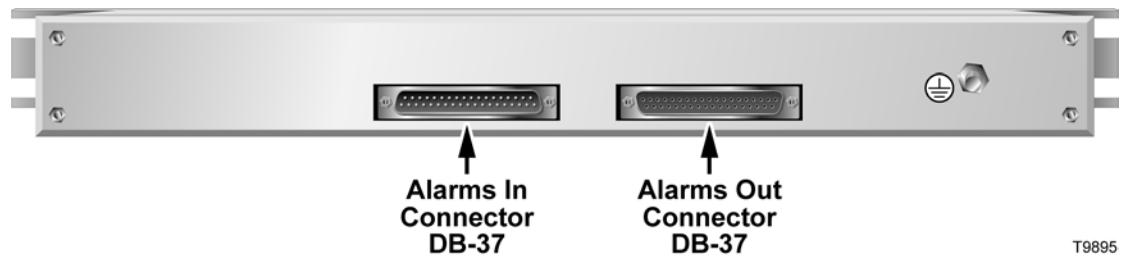

Close-up of Front Panel Terminal Strips



T11921

3

Operation using ICIM

Introduction

The procedures in this chapter apply if you are using the Prisma II ICIM2 front-panel interface to configure and operate the module. For information on using CLI commands or the ICIM Web Interface to configure and operate the module, see the *Prisma II Platform Remote User Interface Guide, System Release 2.03*, part number 4025477.

Scope of This Chapter

Included in this chapter are descriptions of the ICIM2 front-panel keyboard and liquid crystal display (LCD), and detailed procedures on how to use front-panel menus to configure the module.

Note: You must use CLI commands or the ICIM Web Interface to configure and operate the module when using the ICIM2-XD. For details, see the *Prisma II Platform Remote User Interface Guide, System Release 2.03*, part number 4025477.

In This Chapter

■ ICIM Introduction.....	37
■ ICIM2 Front Panel.....	39
■ ICIM Password.....	42
■ Operating the ICIM	47
■ Setting SNMP Trap Receiver Parameters.....	51
■ Checking the Operating Status using the ICIM.....	52
■ Configuring the Module using the ICIM.....	54
■ Checking Module Alarms using the ICIM.....	56
■ Checking Manufacturing Data using the ICIM.....	59
■ Saving the Configuration using the ICIM	61
■ SNMP Configuration.....	62
■ Community Names	65
■ New SNMP Variables.....	66
■ Boot Dialog for ICIM/SNMP Configuration.....	68
■ Adjusting Alarm Thresholds.....	71

ICIM Introduction

Laser Warning

**WARNING:**

- **Avoid personal injury! Use of controls, adjustments, or procedures other than those specified herein may result in hazardous radiation exposure.**
 - **Avoid personal injury! The laser light source on this equipment (if a transmitter) or the fiber cables connected to this equipment emit invisible laser radiation. Avoid direct exposure to the laser light source.**
 - **Avoid personal injury! Viewing the laser output (if a transmitter) or fiber cable with optical instruments (such as eye loupes, magnifiers, or microscopes) may pose an eye hazard.**
- Do not apply power to this equipment if the fiber is unmated or unterminated.
 - Do not stare into an unmated fiber or at any mirror-like surface that could reflect light emitted from an unterminated fiber.
 - Do not view an activated fiber with optical instruments (e.g., eye loupes, magnifiers, microscopes).
 - Use safety-approved optical fiber cable to maintain compliance with applicable laser safety requirements.
 - Even if the unit is off, there may still be hazardous optical levels present.

ICIM Function

The ICIM functions as the module-user interface as well as the interface between the Prisma II modules and the Transmission Networks Control Systems (TNCS).

The ICIM allows local module configuration and status monitoring for up to 140 modules located in multiple chassis. The ICIM features easy-to-use software that can be navigated locally on models equipped with a front-panel keypad and LCD display.

The ICIM can also be navigated remotely using CLI commands or the ICIM Web Interface. For additional information, see the *Prisma II Platform Remote User Interface Guide, System Release 2.03*, part number 4025477.

Important:

- Do not operate any Prisma II Chassis without a fan tray installed properly. If a fan tray is not installed in the Prisma II Chassis, the ICIM will not communicate with any of the modules in that chassis.
- All chassis connected in a daisy-chain must be powered and have a fan tray

installed. A chassis that is connected but is either not powered, or does not have a fan tray installed will cause faulty operation of the ICIM.

- All chassis connected in this daisy-chain must have a unique chassis identification (ID) number.
- The last chassis in the daisy-chain must have a terminator installed in the ICIM OUT connector. Otherwise, faulty communication with the ICIM may occur.

ICIM Block Diagram

A block diagram representing the ICIM2 or ICIM2-XD is shown below.

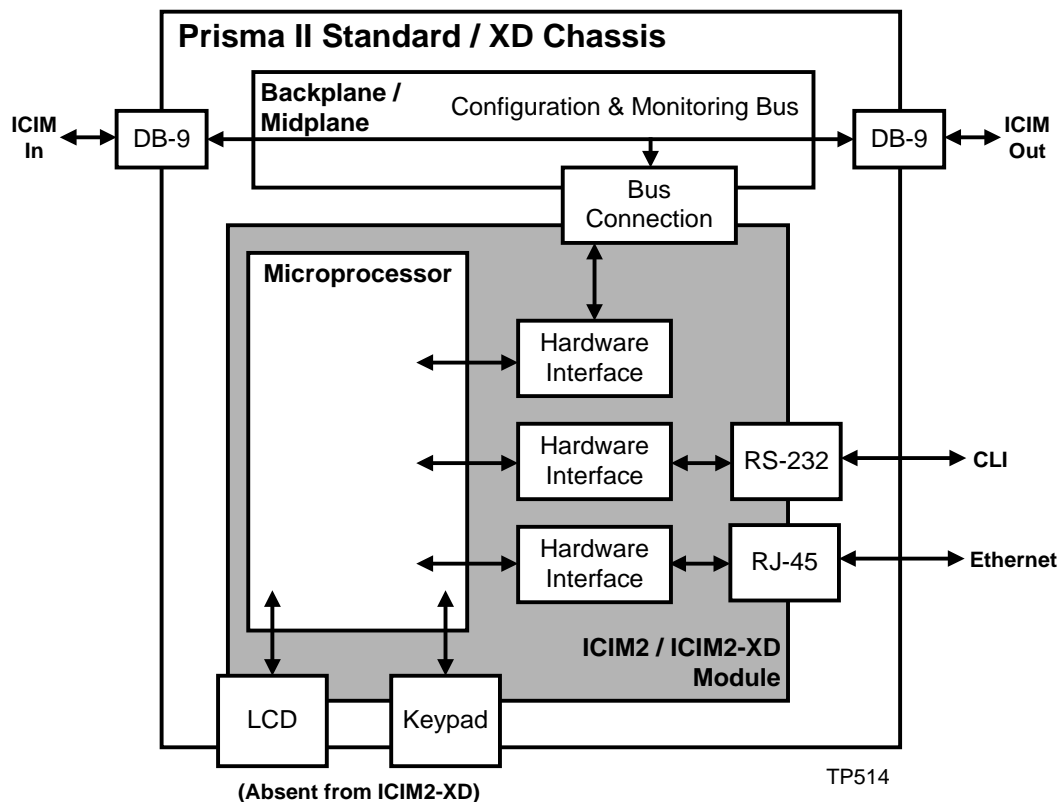

ICIM2 Front Panel

ICIM2 Illustration (Front Panel)

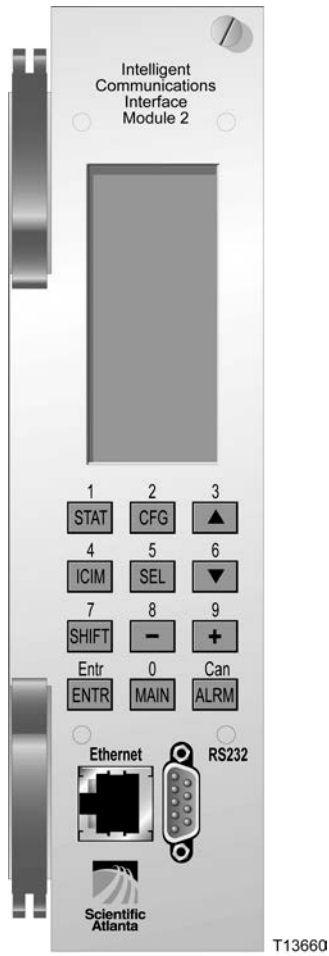

ICIM2 Front Panel Features

Part	Function
LCD screen	Displays the ICIM2 menus, alarms, and status information.
12-key numeric keypad	Used to navigate the ICIM2 menus and configure the application modules.
Ethernet connector	Directly connects the ICIM2 to an IP network. The ICIM2 Ethernet port is suitable for connection to intra-building wiring, non-exposed wiring or cabling only.
Yellow LED on Ethernet connector	Glows when the Ethernet port is operating in full duplex. Blinks when collisions occur on the Ethernet port.
Green LED on Ethernet connector	Glows when a link is established on the Ethernet port. Blinks during data activity on the Ethernet port.
RS232 connector	Used to connect a PC to the Prisma II system for CLI communication and setup.

ICIM LCD

The ICIM LCD is the operator's visual link to the ICIM software. When the ICIM is installed and powered up, the **MAIN** menu is displayed on the LCD.

ICIM MAIN Menu Illustration













The ICIM MAIN menu is shown below.

MAIN
Offline
Modules 15
Alarms 0
Scroll
Module Shelf Slot

TP011

ICIM Keypad

The ICIM keypad has 12 keys that allow you to input and monitor operational parameters. Each key and a brief description of its function are shown here.

Button	Function
	Displays status information for the selected module.
	Displays configuration information for the selected module.
	Displays all of the parameters in alarm for a selected module.
	Moves the menu selection area up. Also increases numerical readings of selected configuration parameters.
	Moves the menu selection area down. Also decreases numerical readings of selected configuration parameters.
	Selects the highlighted parameter.
	Displays ICIM module information such as firmware version, serial number, and baud rate.
	Shifts function of a keypad button to the function or number label just above that button.
	Decreases numerical readings of selected configuration parameters.
	Increases numerical readings of selected configuration parameters.
	Enters input data (if valid).
	Exits the current menu and displays the MAIN ICIM menu.

ICIM Password

The ICIM allows you to send configuration commands, change alarm thresholds, and restore factory default settings in Prisma II modules. To prevent unauthorized changes to these parameters, you have the option of using a password protection system. Password authorization only applies to configurable parameters. Status and alarm information is always available on the ICIM, regardless of password implementation.

Note: The following instructions pertain to the use of the ICIM2 front-panel interface (LCD and keyboard). Remote password and other administrative functions are also supported using CLI Commands or the ICIM Web Interface. For details, see the *Prisma II Platform Remote User Interface Guide, System Release 2.03*, part number 4025477.

Password Protection System

The ICIM menu options available in the password protection system are shown here.

ICIM Menu Option	Description
User Psw	A user-settable password. <ul style="list-style-type: none"> ■ Created, entered, and changed by the system operator(s) ■ Must be exactly eight digits, using only the 0-9 number keys
Change Psw	Changes an existing user password.
Disable Psw	Disables the user password function.
SA Psw	A service password used by factory personnel only.



Important: If you only want to monitor status and alarm data, skip the password function when it appears on the ICIM menu. You can access all module status and alarm information without a password.

However, once a user password is entered, you are required to enter it every time you want to set configurable parameters to any module controlled by that ICIM. Refer to *Expired Password or Inactive Password Messages* (on page 43) and *To Enter the User Password* (on page 43).

To Access the Password Menu

The Password menu allows you to create, enter, change, or disable the user password. It also allows service personnel to use the factory default password.

- 1 Press the  key.

- 2 Use the  key to scroll down until **Password** is highlighted.
- 3 Press the  key. The Password menu appears. **User Psw** is highlighted.

MAIN	ICIM	ICIM	ICIM
Offline	Shelf 7 Slot 15	Shelf 7 Slot 15	Shelf 7 Slot 15
Modules 0	Mfg Data	Mfg Data	User Psw
Alarms 0	Password IP Setup	Password IP Setup	SA Psw
Scroll	Update Adr	Update Adr	Change Psw
Module Shelf Slot			Disable Psw

TP012

Expired Password or Inactive Password Messages



The entry of a valid password allows changes to system parameters for a period of 10 minutes. If more than 10 minutes has passed since your last keystroke, and you attempt to make any changes to system parameters, the menu displays **Psw Expired**. If, after more than 10 minutes, you attempt to disable the password the menu displays **Failed, Password Not Active**. If either of these messages is displayed, you are required to re-enter the password. To re-enter the password, follow the procedure in *To Enter the User Password* (on page 43).

To Enter the User Password

To use the user password feature, you must create and enter a password of exactly eight digits using only the 0-9 number keys.

The password remains active for 10 minutes after your last keystroke. To change configuration parameters after 10 minutes, you must re-enter your password.

Complete the following steps to enter a user password.

- 1 Access the Password menu as shown in *To Access the Password Menu* (on page 42).
- 2 Press the  key. The user password menu appears.
- 3 When **User Psw/Shift Off** appears, press the  key to display **Shift On**, and then enter the eight digits of your password, using the 0-9 number keys.
 - To change a digit you have just typed, use the **CAN** (Cancel) function by pressing the  key. This deletes the last digit typed.

- 4 Press the **ENTER** key to enter the password. The display updates to show whether your password entry was accepted.
 - If the password is accepted, the word **Accepted** appears in the menu, and you are able to return to the MAIN menu.
 - If the password was rejected, the word **Rejected** appears in the menu. Reasons for a password to be rejected include:
 - Entering more than eight digits for the password.
 - Pressing keys other than the 0-9 number keys.
 - Entering an incorrect password if a valid password has been entered.

If the password is rejected, press the **SHIFT** key to return to the password menu and re-enter the password as described in step 3 above.

ICIM	ICIM	ICIM	ICIM
Shelf 0 Slot 15	Shelf 0 Slot 15	Shelf 0 Slot 15	Shelf 0 Slot 15
User Psw	User Psw *****	User Psw 1234****	User Psw 12345678
Shift Off	Shift On	Rejected Shift Off	Accepted Shift Off

TP013

To Change the User Password

If a user password has been entered, it may be changed. However, the current password must be active prior to changing it. If the current password has expired (more than 10 minutes have passed since your last keystroke), you must re-enter the current password before changing to a new one.

- 1 Access the Password menu as shown in the procedure *To Access the Password Menu* (on page 42).
- 2 Use the **▼** key to scroll down until **Change Psw** is highlighted.
- 3 Press the **SEL** key to select **Change Psw**.
- 4 When **Change Psw/Shift Off** appears, press the **SHIFT** key to display **Shift On**, and then enter the eight digits of your new password, using the 0-9 number keys. If at any time you input a digit that is incorrect or wish to change a digit, use the **CAN** (Cancel) function by pressing the **ALRM** key to delete that digit.

- 5 Press the **ENTER** key to input the new password.
Results:
 - The ICIM updates the display to show if your password entry was accepted or rejected.
 - If the entry was accepted, you are able to return to the MAIN menu.
- 6 If the new password you entered is rejected, press the **SHIFT** key to return to the password entry menu. Clear all digits using the **CAN** (Cancel) function, then re-enter an 8-digit password using only the 0-9 number keys. Press the **ENTER** key to input the password.

ICIM	ICIM	ICIM	ICIM
Shelf 7 Slot 15	Shelf 7 Slot 15	Shelf 7 Slot 15	Shelf 7 Slot 15
User Psw	Change Psw	Change Psw *****	Change Psw 87654321
SA Psw			
Change Psw			
Disable Psw	Shift Off	Shift On	Shift On

TP014

To Disable the User Password using ICIM

If a user password has been entered, you may disable it at any time. However, the current password must be active prior to disabling it. If the current password has expired (more than 10 minutes have passed since your last keystroke), you must re-enter the current password before disabling it.

- 1 Press the **ICIM** key.
- 2 Use the **▼** key to scroll down until **Password** is highlighted.
- 3 Press the **SEL** key.
- 4 Use the **▼** key to scroll down until **Disable Psw** is highlighted.
- 5 Press the **SEL** key to select **Disable Psw**.
- 6 If the current password is active, the menu displays **Password Is Now Disabled**. You can now make changes to parameters without any password.

Chapter 3 Operation using ICIM

- 7 If the current password has expired (more than 10 minutes have passed since your last keystroke), the menu displays **Failed, Password Not Active**. You must re-enter the current password and then repeat this procedure.

ICIM	ICIM	ICIM
Shelf 7 Slot 15	Shelf 7 Slot 15	Shelf 7 Slot 15
User Psw	Enter Psw 8765****	Enter Psw 87654321
SA Psw		
Change Psw	Password Is Now Disabled	Failed, Password Not Active
Disable Psw	Shift Off	Shift Off



TP015

Operating the ICIM

Using the ICIM

Once the module is installed, it runs without the aid of an operator. Unless alarms are generated or your system configuration changes, you should not need to make any adjustments to the module beyond the initial setup.

To Access the ICIM LCD Contrast

To access the ICIM LCD contrast control from the MAIN menu, press the  key. Use the  key to increase or the  key to decrease ICIM display contrast.

ICIM MAIN Menu

A few seconds after power-up, the MAIN menu (shown below) appears. Press the  key to select the specific option.

Display	Description
Offline	Indicates TNCS communication status with the ICIM.
Modules	Indicates the number of modules in the ICIM domain.
Alarms	Displays the number of modules that are in alarm. Selecting this option allows scrolling through all modules in alarm condition.
Scroll	Allows scrolling through all modules in the ICIM domain.
Module Shelf Slot	Allows selection of any specific module in the ICIM domain.

ICIM MAIN Menu Illustration

The ICIM MAIN menu is shown below.

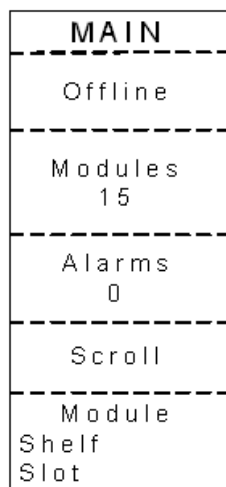

TP011

Prisma II ICIM Menu

To display the ICIM menu, press the **ICIM** key. The ICIM menu (shown below) appears. Press the **SEL** key to select the specific option.

Display	Description
Shelf Slot	Displays the location of the ICIM module.
Mfg Data	Displays manufacturing data about the ICIM.
Password	Allows you to enter, change, or disable a system password. See Using the ICIM Password earlier in this chapter.
Update Adr	If the Chassis ID number switch has been changed, you must highlight the Update Adr menu and press the SEL key for the ICIM to recognize the change.

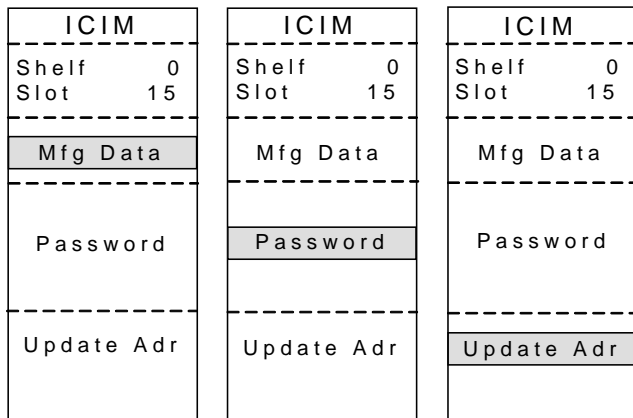

TP016

Prisma II MAIN Menu and ICIM Menu Structure

Pressing the **MAIN** key initiates the MAIN software menu. Pressing the **ICIM** key initiates the ICIM software menu. The MAIN and ICIM software structures are shown below.

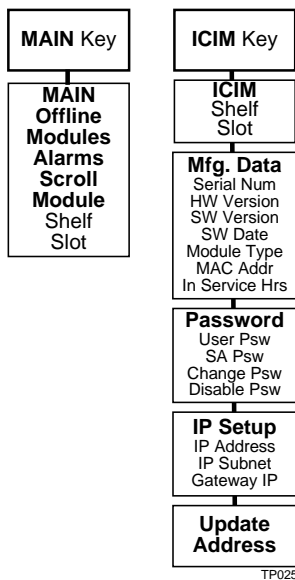

TP025

Prisma II Transmitter Module Software Menu Structure

From the MAIN or SCROLL menus, you can navigate to the MODULE menu. From the MODULE menu, press the **STAT**, **CFG**, or **ALRM** key to display the desired parameter menu.

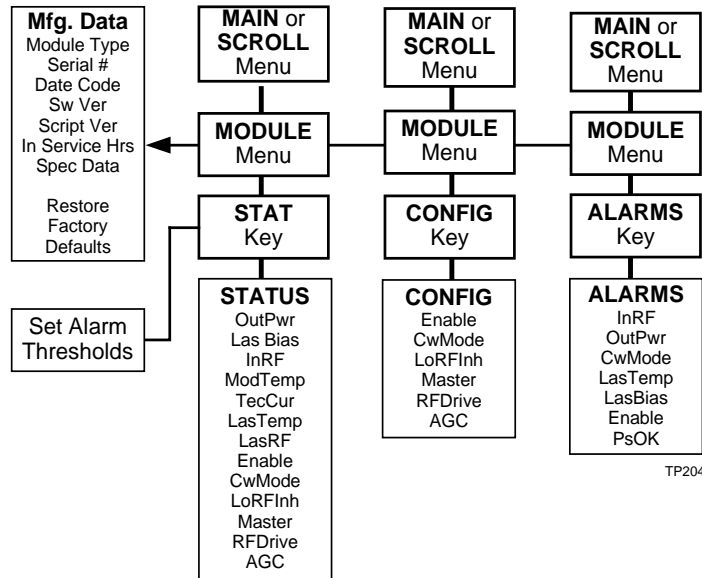

Setting SNMP Trap Receiver Parameters

You can use the SNMP trap receiver parameters to specify up to five IP addresses to which proprietary traps will be sent. You can also specify the events that will result in a trap being sent to the network management systems at these IP addresses.

The Cold Start trap will always be sent to all network management systems. The Authentication Failure trap will also be sent to all trap receivers if the `snmpEnableAuthenTraps` is set to Enabled.

You can specify which enterprise specific traps are sent to each trap receiver by setting variables in the `P2TrapRecv` table.

To Set Traps for a Specific IP Address using `P2TrapRecvEntry`

Entries to the `P2TrapRecvEntry` file can be made to send the trap information to a trap handler. The SNMP agent automatically sends an alert when the value of an object changes or exceeds a predefined threshold.





- 1 On an SNMP manager, go to the `P2TrapRecvEntry` table.
- 2 Type the IP address to which you want the trap sent.
- 3 Select **Enable** from the drop-down list.

Result: The new IP address is enabled and traps are sent to this IP address. Any changes are immediately stored to the EEPROM, so the changes are not lost if power is lost or the ICIM is reset.



Checking the Operating Status using the ICIM





To Check the Operating Status using ICIM

You can use the ICIM to check the status of all operating parameters of this module. All status information is displayed on the ICIM LCD.

- 1 At the MAIN menu, press the  key to highlight the **Shelf** and **Slot** fields.
- 2 Press the  key to address the **Shelf** number. Then press the  key or the  key to scroll to the number of the desired shelf.
- 3 Press the  key.

Result: The **Slot** field is highlighted.

- 4 Press the  key or the  key to scroll to the number of the desired slot.
 - 5 Press the  key.
- Result:** The **MODULE** menu displays on the ICIM.

- 6 Press the  key.
- 7 Press the  key or the  key to scroll through the monitored parameters until you find the parameter of interest.
- 8 Check the status of the desired parameter or select other parameters to monitor.
When finished, press the  key to return to the **MAIN** menu.

STATUS Menus

Press the **STAT** key to select the STATUS menu. Typical STATUS menus are shown below.

STATUS	STATUS	STATUS	STATUS
Shelf 5 Slot 12	Shelf 5 Slot 12	Shelf 5 Slot 12	Shelf 5 Slot 12
HDTx	HDTx	HDTx	HDTx
OutPwr 8.2 dBm	InRF -11.5 dB	TecCur -225 mA	LasRF -3.890dB
LasBias 123 mA ▲ ▼	ModTemp 54.3 degC ▲ ▼	LasTemp 25.5 degC ▲ ▼	Enable ON ▲ ▼















TP205

Note: For details on all operating status parameters, see *Module Parameter Descriptions* (on page 105).



Configuring the Module using the ICIM

To Configure Parameters using the ICIM

You can use the ICIM to configure the parameters of this module.

- 1 From the **MAIN** menu, press the  key to highlight the **Shelf** and **Slot** fields.
- 2 Press the  key to address the **Shelf** number. Then press the  key or the  key to scroll to the number of the desired shelf.
- 3 Press the  key.
Result: The **Slot** field is highlighted.
- 4 Press the  key or the  keys to scroll to the number of the desired slot.
- 5 Press the  key.
Result: The **MODULE** menu appears on the ICIM LCD.
- 6 To configure the module, press the  key.
- 7 Press the  key or the  key to scroll through the configurable controls until you find the parameter of interest.
- 8 Press the  key to select the highlighted control.
- 9 Press the  key or the  key to activate or change the value of the selected control.
- 10 Press the  key to save the changes and return to the **MAIN** menu.

CONFIG Menus

When the **CONFIG** menu is selected, the **Shelf** number field is highlighted. The shelf and slot number fields may only be incremented with the  key or the  key. The  key highlights the **Slot** number field. Once you exit the slot field, the Up and Down arrows will scroll through the parameters that are specific to this module.

Sample CONFIG menus are shown below.

CONFIG	CONFIG	CONFIG	CONFIG
Shelf 5 Slot 12	Shelf 5 Slot 12	Shelf 5 Slot 12	Shelf 5 Slot 12
HDTx	HDTx	HDTx	HDTx
Enable ON	CwMode OFF	LoRFinh ON	AGC OFF

TP206

Note: For details on all configurable parameters, see *Module Parameter Descriptions* (on page 105).

Checking Module Alarms using the ICIM



To Check Alarms using ICIM

If the red ALARM LED on the front panel is blinking, a minor alarm condition is indicated. If the ALARM LED on the front panel is illuminated, a critical alarm conditions is indicated.

Alarms fall into one of the following categories.



- Major low
- Minor low
- Minor high
- Major high

1 From the MAIN menu, press the  key to highlight the **Shelf** and **Slot** fields.

2 Press the  key to address the **Shelf** number. Then press the  key or the  keys to scroll to the number of the desired shelf.

3 Press the  key.

Result: The **Slot** field is highlighted.



4 Press the  key or the  key to Scroll to the number of the desired slot.

5 Press the  key.

Result: The **MODULE** menu displays on the ICIM.

6 Press the  key.

Result: Module alarm conditions display.





7 Use the  key or the  key to scroll through alarm conditions until the desired alarm is displayed.

8 Monitor the alarm condition(s). Take appropriate action. Verify that all settings and thresholds relating to the alarm indication are set correctly to rule out an unintended alarm.

9 When finished, press the  key to return to the MAIN menu.

ALARMS Menus

When a module **ALARMS** menu is selected, press the  key or the  key to scroll through alarms. Some typical **ALARMS** menus are shown below.











ALARMS		ALARMS	
Shelf	5	Shelf	5
Slot	12	Slot	12
HDTx		HDTx	
InRF MinL		OutPwr MinH	
 		 	

TP207

Note: For details on all alarm parameters, see *Module Parameter Descriptions* (on page 105).

To Set Adjustable Alarm Thresholds using the ICIM

You can use the ICIM to change the adjustable alarm thresholds of this module from their factory default values.

- 1 At the MODULE menu, press the  key.
Result: The STATUS menu appears on the ICIM LCD.
- 2 Press the  key. The alarm thresholds previously set are displayed. If the label **n/a** is displayed, you cannot configure that alarm threshold. Press the  key to highlight the alarm threshold for the next parameter.
- 3 When the threshold that you wish to set is highlighted, press the  key.
- 4 Press the  key or the  key to change the increment size.
- 5 Press the  key or the  key to adjust the alarm threshold.
Note: Press the Cancel () key to return to the previous menu.
- 6 Press the  key to save the changes.
Result: **Data Saved** displays.
- 7 When finished, press the  key to return to the MAIN menu.

Alarm Threshold Menus

Some typical alarm threshold menus are shown below.

STATUS		STATUS	
Shelf	5	Shelf	5
Slot	12	Slot	12
HDTx		HDTx	
LasTemp		LasBias	
MajH	40.00	MajH	62.20
MinH	30.00	MinH	52.20
MinL	20.00	MinL	32.20
MajL	10.00	MajL	22.20

TP208









Note: For details on all alarm thresholds, see *Module Parameter Descriptions* (on page 105).

Checking Manufacturing Data using the ICIM

To Check Manufacturing Data

You can display the manufacturing data for this module on the ICIM LCD.



Complete the following steps to access the manufacturing data.

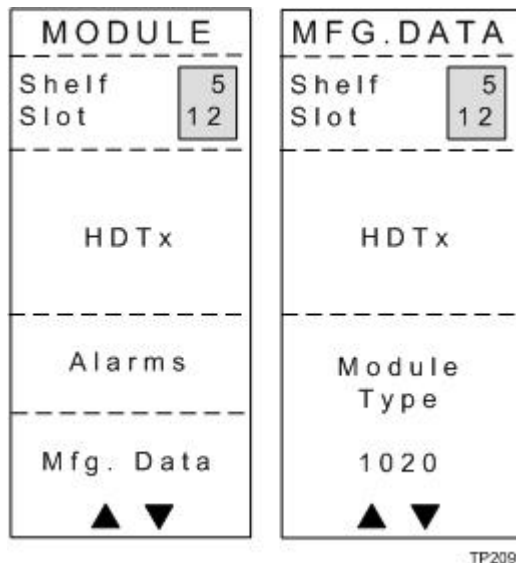







- 1 From the MAIN menu, press the  key to highlight the **Shelf** and **Slot** fields.
- 2 Press the  key to address the **Shelf** number. Then press the  key or the  key to scroll to the number of the desired shelf.
- 3 Press the  key. The **Slot** field is highlighted.
- 4 Press the  key or the  key to scroll to the number of the desired slot.
- 5 Press the  key. The MODULE menu for this module will be selected, as shown on the left below. Press the  key to enter the start of the MFG. DATA menus, as shown on the right below.



Use the  and  keys to scroll through the manufacturing data.

MFG. DATA Menus

When the **MFG. DATA** menu is selected, the  key or the  key allows you to scroll through the manufacturing parameters specific to this module. Sample **MFG. DATA** menus are shown below.

MFG. DATA	MFG. DATA	MFG. DATA	MFG. DATA
Shelf 5 Slot 12	Shelf 5 Slot 12	Shelf 5 Slot 12	Shelf 5 Slot 12
HDTx	HDTx	HDTx	HDTx
Module Type 1020	Serial # AAYCUA Date Code B01	Sw Rev 1.55 Script Ver 24	In Service Hours 100
 	 	 	 

TP210

Note: For details on all manufacturing data parameters, see *Module Parameter Descriptions* (on page 105).

Saving the Configuration using the ICIM

To Save the Current Configuration

- 1 After you have changed a parameter or entered data, press the **ENTER** key to save the changes and return to the MAIN menu.
- 2 If you do not save your changes for two minutes, or if you press the **SHIFT** **CAN** keys at the same time, changes are aborted and the display returns to the MAIN menu.

Configuration Complete

If no alarms are indicated after using the ICIM to configure this module to your system specifications, no further action is necessary. The module operates without further input. Alarms, changes in operating parameters, electrical power fluctuations, or changes in system design may be cause for additional action.

SNMP Configuration

The IP Setup menu item in the ICIM menu allows you to enter an IP address, IP subnet, and Gateway IP in order to configure the ICIM for remote status monitoring and control by an SNMP network management system.

This section does not describe how to implement SNMP. Refer to your SNMP manager documentation or MIB information for instructions on implementing SNMP, Version 1.

All of this configuration is also available through the Boot Dialog. The Boot Dialog also allows community names and the default port number for traps to be changed.

Note: Contact Cisco Services for MIB files.

SNMP Considerations

The following items should be considered when implementing SNMP.

- The SNMP connection is made through the Ethernet port on the front of the ICIM. (Use 10baseT cable with an RJ-45 connector.) To meet the requirements of GR1089-CORE, a shielded cable must be used and both ends must be grounded.
- The network management system (NMS) must be installed behind a firewall to prevent any ill-intentioned persons with an SNMP manager from accessing and tampering with the ICIM.
- When the ICIM has to handle excessive SNMP traffic, it will respond slowly to both SNMP control and front panel input. If this occurs, reduce the update rate of the SNMP manager.

Basic SNMP Setup

Refer to your SNMP manager documentation or MIB information for instructions on implementing SNMP. Before you can use and reconfigure SNMP services, you need to know the community strings in your network and the IP addresses or computer names for SNMP management hosts to which traps are sent.

To Set Up the IP Configuration Parameters for SNMP Support using ICIM













- 1 Press the  key.

Result: The ICIM menu appears.

- 2 Select the **Password** menu and enter the User Password.

Result: The ICIM allows configuration changes for the next 10 minutes.

Note: Refer to your specific hardware Installation and Operation Guide for more information on using, entering, or changing the ICIM user password.

- 3 Press the  key.
Result: The ICIM menu appears.
- 4 Use the  key to scroll down until **IP Setup** is highlighted.
- 5 Press the  key.
Result: The IP Setup menu appears.
- 6 Use the  or  keys to scroll to and highlight the desired configuration parameter; IP Address, IP Subnet, or Gateway IP.
- 7 Press the  key.
Result: The Adjust menu for the selected IP parameter displays and the first segment of the address is highlighted.
- 8 Enter the correct numbers for the first segment of the address.
Note: One of two methods can be used to enter the numbers, as follows:
 - Press the  or  keys to increase/decrease the number to set value.
 - Press the  key to change to the numeric entry mode. Confirm that **Numlock On** appears on the front panel LCD. Then enter the exact number using the number keys on the 12-key numeric keypad.
- 9 Press the  key to accept your entry and move to the next address segment to the right. You can also use the  or  keys to move to the address segment of your choice.
Note: If you are using the numeric entry mode, the cursor moves to the next address segment to the right automatically after you enter the last digit of the current address segment.
- 10 Repeat steps 8 and 9 until all address segments are entered.
Result: After you enter the last address segment and press the Enter key, the system returns to the IP Setup menu.
- 11 Repeat steps 6 through 10 for each IP Setup parameter that you need to enter.
- 12 Restart the ICIM.
Important: IP Setup parameters do not take effect until the ICIM is restarted.

To Restart the ICIM by Removing the ICIM

- 1 Unscrew the captive screw near the top right-hand corner of the ICIM.
- 2 Unlock the top and bottom ejector levers near the left-hand side of the ICIM.
- 3 Pull the ejector levers out and away from the front panel to disconnect the ICIM from the chassis backplane connector.
- 4 Pull the ICIM at least 1.5 inches (3.81 cm) out from the front of the chassis to ensure that it is fully separated from the chassis backplane connector.
- 5 Reinsert the ICIM into the chassis until the ejector levers insert into their respective slots in the chassis.
- 6 Push the ejector levers in and flat against the ICIM front panel to reconnect the ICIM to the backplane connector until the ejector levers lock in place.
- 7 Screw in the captive screw to secure the ICIM in the chassis.

Community Names

Default Community Strings

The community string provides primitive security and context checking for both agents and managers that request and initiate trap operations. An agent does not accept a request from a manager outside the community.

Community strings that the expects are:

Read Community	public
Write Community	private
Trap Community	SNMP_trap

New SNMP Variables

Support for traps requires additional data available through SNMP. This additional data may be useful even if not using traps.

SNMP is the only way this additional data can be accessed. It cannot be accessed through the ICIM front panel or an SMC interface.

Table of Inserted Modules

This table is named p2InsertModuleTable. It contains a list of modules inserted since the last time the ICIM was reset or told to update the chassis ID for all modules. It does not include modules found when the initial search for modules is performed.

The modules are displayed in chronological order, with the most recently inserted module always being in index position 1. If the number of modules inserted exceeds the capacity of the table, the oldest entries are deleted.

This table only contains the chassis and slot ID for a detected module. It is necessary to look at the other tables for more information.

Each row of this table is made up of the following variables:

Variable	Description
p2InsertModuleIndex	The index for this table. The most recently inserted module is always in index position 1.
p2InsertModuleChassisID	The chassis ID number of the new module.
p2InsertModuleSlotID	The slot ID number of the new module.

Table of Removed Modules

This table is named p2RemoveModuleTable. It contains a list of modules removed since the last time the ICIM was reset or told to update the chassis ID for all modules.

The modules are displayed in chronological order, with the most recently removed module always being in index position 1. If the number of modules removed exceeds the capacity of the table, the oldest entries are deleted.

If a module is removed before the "plug-and-play" data is read in, the type, name, and serial number are blank.

Each row of this table is made up of the following variables:

Variable	Description
p2RemoveModuleIndex	The index for this table. The most recently removed module is always in index position 1.
p2RemoveModuleChassisID	The chassis ID number of the removed module.
p2RemoveModuleSlotID	The slot ID number of the removed module.
p2RemoveModuleName	The name of the removed module. This is the name from the plug-and-play data for this module, and matches what the ICIM and SNMP display as the name. TNCS and LCI may use a different name.
p2RemoveModuleType	The TNCS type number of the removed module. This number uniquely identifies every type of module.
p2RemoveModuleSerialNum	The serial number of the removed module. This information is needed to determine if a module has been replaced with one that is the same type.

Previous IP Address

This variable is named p2PreviousIP. When the IP of the ICIM is changed using the front panel, this variable returns the previous ICIM IP address. It returns 0.0.0.0 until the IP address of the ICIM is changed for the first time.

Boot Dialog for ICIM/SNMP Configuration

The boot dialog is presented whenever the ICIM is powered up (a cold boot). It is accessible via the LCI communications port on the front of the chassis.

Important: A null modem is required along with a terminal emulator program, such as HyperTerminal on a Windows PC.

The serial port on the PC used by the terminal emulator program should be set up with these parameters:

- 9600 baud
- 8 data bit
- No parity bit
- 1 stop bit

This parameter is often displayed as: 9600 8-N-1

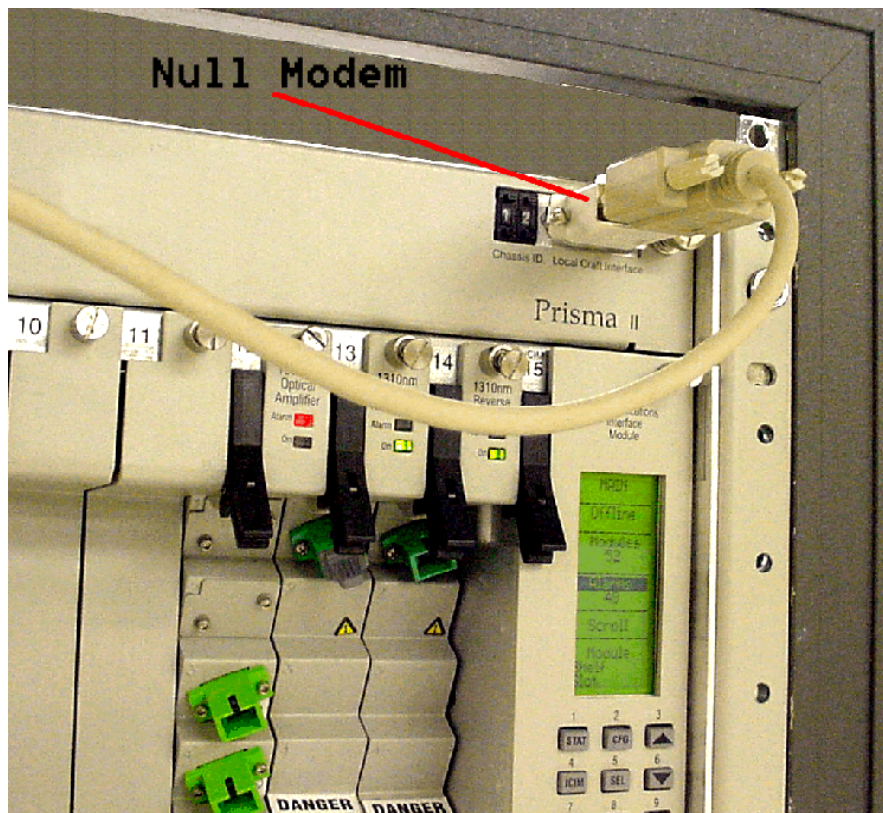

The boot dialog's primary use is to flash a new version of the ICIM application via a TFTP server.

Important: Do this only under the direction of Cisco Services.

During a flash operation, the low-level parameters can be changed, including community strings, port number for traps, IP address, etc.

The procedures below initially tell the ICIM that it is to be updated (flashed), whereupon it presents a configuration dialog. After new values are entered and saved, the ICIM is told to **not** update the program and proceed to normal ICIM operations.

To Prepare to Change Parameters

- 1 When the ICIM is powered up, it presents a summary screen along with a prompt to "...press any key within 5 seconds."

Result: The following information appears.

```

Start-Up Configuration Dialog
Copyright (c) 2000 - 2004, Cisco Systems, Inc.
-----
START-UP MODE:
  Run ICIM Application
NETWORK INTERFACE PARAMETERS:
  IP address on LAN is 192.133.194.219
  LAN interface's subnet mask is 0xfffff00
SNMPv1 COMMUNITY:
  Read Community: public           Write Community: private
  Trap Community: SNMP_trap       Trap Port: 162
HARDWARE PARAMETERS:
  Serial channels will use a baud rate of 9600
  Board's Serial Number is ^AAIIJHC
HARDWARE PARAMETERS:
  ICIM BSP Revision: ICIM Boot Rom, Rev: BT 0204 (02-23-2004)
  MPC860 (Rev 0.2) CPU running at 49 Mhz with 5 Mhz input clock
  ICIM Board with 16 Mbytes DRAM and 4 Mbytes App FLASH and 2 Mbytes Boot
  FLASH
  This board's Ethernet hardware address is 0:2:DE:1:2:3
BOOT ROM PARAMETERS:
  IP address of the TFTP host is 192.133.194.4
  The file to download and start is ram.crc
  After board is reset, start-up code will wait 5 seconds
-----
To change any of this, press any key within 5 seconds.

```

Note: During the first couple of seconds, the ICIM does not respond to a key press.

- 2 Press any key repeatedly until the following prompt appears.

```
(M)odify any of this or (C)ontinue? [M]
```

- 3 Press **Enter** to get the default value for Modify.

```

For each of the following questions, you can press < Return > to
select the value shown in braces, or you can enter a new value.
How should the board boot?
1. pROBE+ (for debugging)
2. TFTP (for code download)
3. Run ICIM Application
Which one do you want? [3] 2

```

- 4 Select **2** for TFTP.

Note: We will **not** be doing a code download, but this gets access to the rest of the parameters dialog.

To Change Parameters

Below is an example dialog where one of the parameters (Trap Community) is changed. Any of the parameters can be changed, although some should be changed only with the advice of Cisco services.

Note: Hardware parameters (serial channel baud rate, serial number, and board Ethernet address) should **not** be changed.

```

NETWORK INTERFACE PARAMETERS:
Do you want a LAN interface? [Y]
This board's LAN IP address(0.0.0.0 = RARP)? [192.133.194.219]
Subnet mask for LAN (0 for none)? [255.255.255.0]
Should there be a default gateway for packet routing? [Y]
What is its IP address? [192.133.194.254]
SNMP COMMUNITY STRINGS:
Read Community [public]
Write Community [private]
Trap Community [SNMP_trap] ICIM_Trap
Trap Port for P2 traps [162]
HARDWARE PARAMETERS:
Baud rate for serial channels [9600]
Enter the Serial number? [^AAIIJHC]
HARDWARE PARAMETERS:
Do you want to change the board's Ethernet address? [N]
BOOT ROM PARAMETERS:
IP address of the TFTP Boot server to boot from? [192.133.194.4]
What is the name of the file to be loaded and started? [ram014.crc]
How long (in seconds) should CPU delay before starting up? [5]

```

Each time a prompt is given, the default value is displayed in square brackets.

- 1 Press **Enter** to retain the current value and move onto the next parameter.

Note: As an example in the above screen, the Trap Community string has been changed to a new value. The prompt for delay time is the last one before the summary screen is presented.

- 2 Press any key repeatedly until the following prompt appears.

```
(M)odify any of this or (C)ontinue? [M]
```

- 3 Press **Enter** to get the default value for Modify.

To Restart the ICIM using ICIM

The boot selection dialog appears again.

```

For each of the following questions, you can press < Return > to select the
value shown in braces, or you can enter a new value.
How should the board boot?
1. pROBE+ (for debugging)
2. TFTP (for code download)
3. Run ICIM Application
Which one do you want? [2] 3

```

- 1 Select **3** to indicate that the normal ICIM application should be run (instead of TFTP).

Result: The summary page appears.

- 2 Do nothing and when the 5 second timeout expires, the ICIM restarts normally.

Adjusting Alarm Thresholds

To Adjust Alarm Thresholds

Relative alarm thresholds are both displayed and stored as relative values. This method for adjusting alarm thresholds lets you choose any valid increment size and adjust the alarm threshold to any valid value.

You can use the ICIM to change the adjustable alarm thresholds of this module from their factory default values.

- 1 At the MODULE menu, press the **STAT** key.
Result: The STATUS menu appears on the ICIM LCD.
- 2 Press the **SEL** key. The alarm thresholds previously set are displayed. If the label **n/a** is displayed, you cannot configure that alarm threshold. Press the **▼** key to highlight the alarm threshold for the next parameter.
- 3 When the threshold that you wish to set is highlighted, press the **ENTER** key.
- 4 Press the **▼** key or the **▲** key to change the increment size.
- 5 Press the **+** key or the **-** key to adjust the alarm threshold.
Note: Press the Cancel (**ALRM**) key to return to the previous menu.
- 6 Press the **ENTER** key to save the changes.
Result: Data Saved displays.
- 7 When finished, press the **MAIN** key to return to the MAIN menu.

4

Operation using LCI

Introduction

This chapter provides LCI installation instructions and detailed descriptions of how to use LCI. This chapter applies to you if you are using the Local Craft Interface (LCI) to operate a module.

In This Chapter

■ LCI Introduction	74
■ System Requirements	75
■ Installing LCI	76
■ Connecting Your Computer to the Chassis	79
■ Starting LCI Software	81
■ LCI Module Tree	83
■ Accessing the Module Detail Information	84
■ Checking the Operating Status	89
■ Configuring the Module using LCI	91
■ Checking the Module Alarms using LCI	93
■ Modifying Module Alarm Limits using LCI	95
■ Checking Manufacturing Data using LCI	97

LCI Introduction

Laser Warning



WARNING:

- **Avoid personal injury!** Use of controls, adjustments, or procedures other than those specified herein may result in hazardous radiation exposure.
 - **Avoid personal injury!** The laser light source on this equipment (if a transmitter) or the fiber cables connected to this equipment emit invisible laser radiation. Avoid direct exposure to the laser light source.
 - **Avoid personal injury!** Viewing the laser output (if a transmitter) or fiber cable with optical instruments (such as eye loupes, magnifiers, or microscopes) may pose an eye hazard.
- Do not apply power to this equipment if the fiber is unmated or unterminated.
 - Do not stare into an unmated fiber or at any mirror-like surface that could reflect light emitted from an unterminated fiber.
 - Do not view an activated fiber with optical instruments (e.g., eye loupes, magnifiers, microscopes).
 - Use safety-approved optical fiber cable to maintain compliance with applicable laser safety requirements.
 - Even if the unit is off, there may still be hazardous optical levels present.

LCI Function

LCI is software that functions as a user interface for the Prisma II platform. LCI is installed on a computer, which is then connected to a Prisma II Chassis. Using LCI, you can configure and monitor the modules in the chassis to which the computer is connected.

Important: Do not operate any Prisma II Chassis without a fan tray installed. If a fan tray is not installed in the Prisma II Chassis, the LCI will not communicate with any of the power supplies in that chassis.

System Requirements

You will need the following computer software and hardware to run LCI.

Computer Requirements

- Pentium II 300 MHz processor or equivalent
- 128 MB RAM
- 10 MB available hard drive space
- CD-ROM Drive
- Windows 95 or later operating system software

Cable Requirements

The required cable is a standard serial extension cable, DB9 Female to DB9 Male. This cable can be purchased locally or ordered from the factory as part number 180143. The connectors are a serial 9-pin D-shell (EIA 574/232).

Installing LCI

This section describes how to install your LCI software.

To Install the LCI Software

Complete the following steps to install the LCI software.

- 1 Close all programs that are running on your computer.
- 2 Insert the LCI CD-ROM into your CD-ROM drive.

Results:

- The LCI software installation program starts automatically. If the installation program does not start automatically, open Windows Explorer and double-click the file **setup.exe** on the LCI CD-ROM.
- The Welcome screen appears as shown in the following illustration.

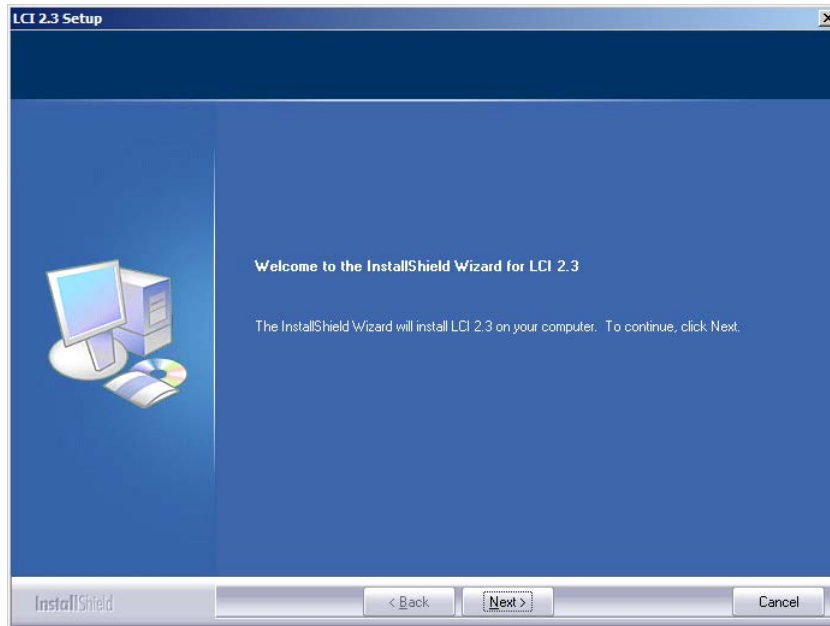

- 3 Click **Next** to continue with the installation process.

Result: The Ready to Install the Program screen appears as shown in the following illustration.

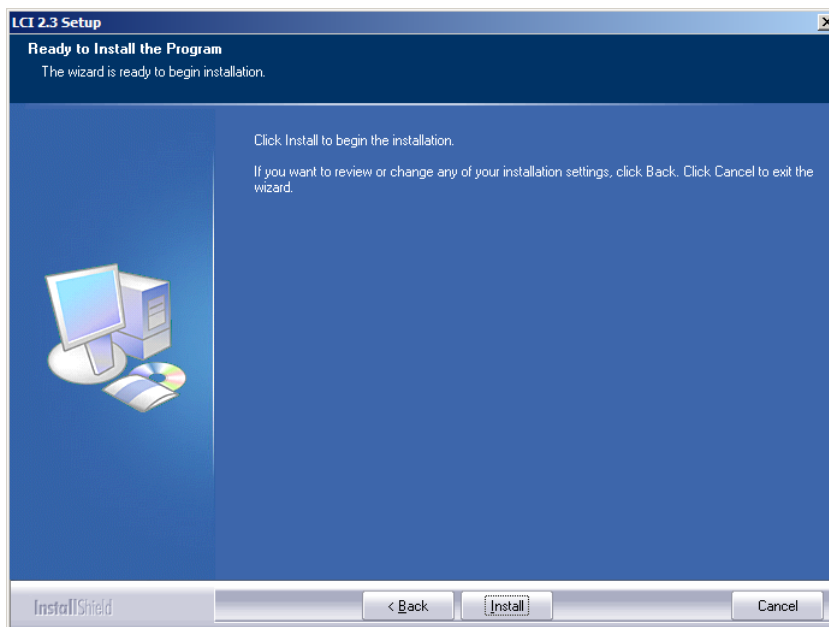

- 4 Click **Install** to begin installation.

Result: After a moment, the **Setup Status** screen appears displaying a progress indicator, as shown in the following illustration.

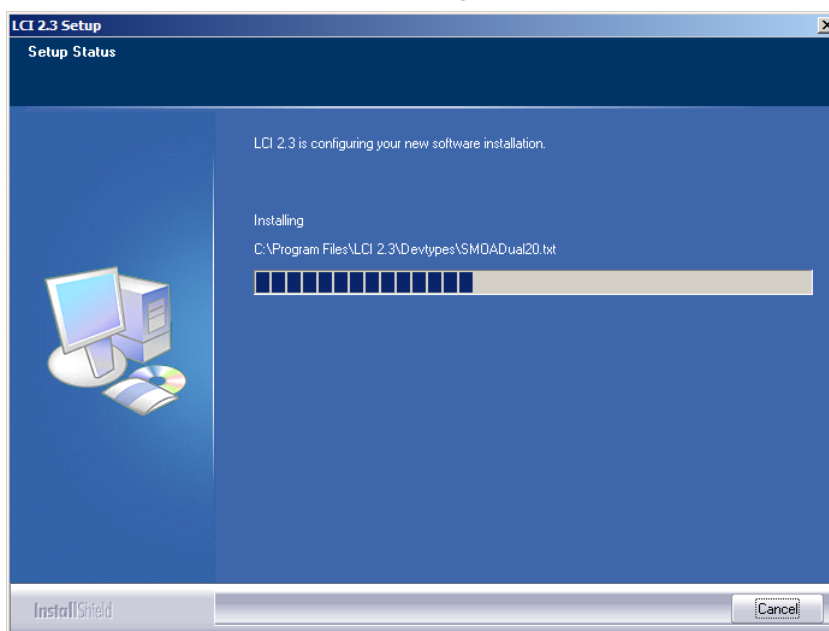

- 5 When finished, the InstallShield Wizard Complete screen appears, as shown in the following illustration.

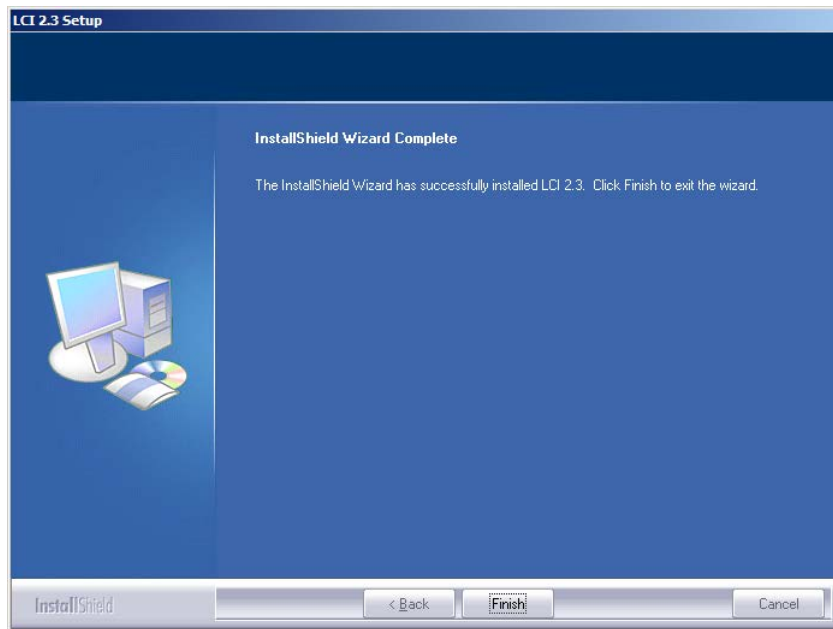

- 6 Click **Finish** to exit the Install wizard.

Result: An LCI shortcut is placed on your Windows desktop, as shown in the following illustration.



The LCI software is now ready to use.

Connecting Your Computer to the Chassis

Before you start LCI, you must first connect your computer to the chassis that contains the module(s) you want to check.

Important:

- LCI only communicates with modules installed in the chassis to which your computer is connected. To check other modules, you must connect your computer to the chassis in which they are installed.
- If LCI does not communicate with a module in the chassis to which your computer is connected, it may be necessary to update the LCI application.

To Connect a Computer to the Chassis

Complete the following steps to connect your computer to the chassis.

- 1 Plug one end of a 9-pin RS-232serial extension cable into your computer.
- 2 Plug the other end of the cable into the LCI port, labeled **Local Craft Interface**.

Standard Prisma II Chassis

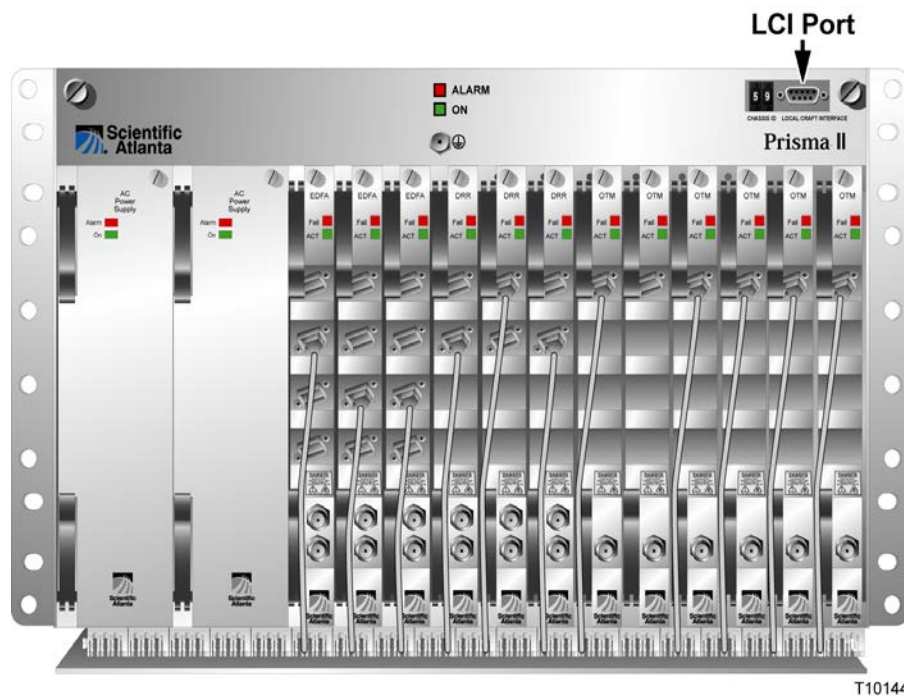

Prisma II XD Chassis (Top Right Corner Detail)



Starting LCI Software

When you start LCI, it polls the module(s) located in the chassis to which your computer is attached. For each module it finds, LCI does the following:

- Represents the module in the module tree of the main LCI window
- Makes the polling information available so you can check and configure various parameters

Important: Your computer must be connected to the chassis before you start LCI. For instructions, refer to *Connecting Your Computer to the Chassis* (on page 79).

To Start LCI Software

Complete the following steps to start the LCI software.

- 1 Double-click the LCI icon on your Windows desktop.



Result: The LCI Detect Configuration window appears as shown below.

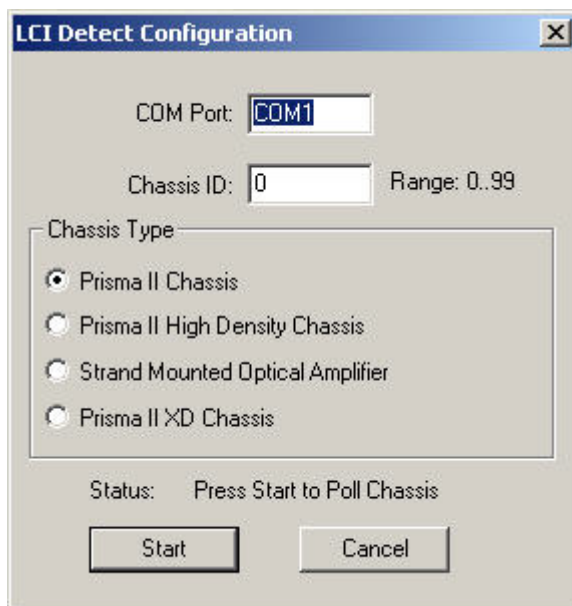

- 2 In the LCI Detect Configuration window, select the appropriate COM port, chassis ID, and chassis type, and then click **Start**.

Result: LCI polls the modules in the chassis, and when finished, displays a Refresh Complete message.

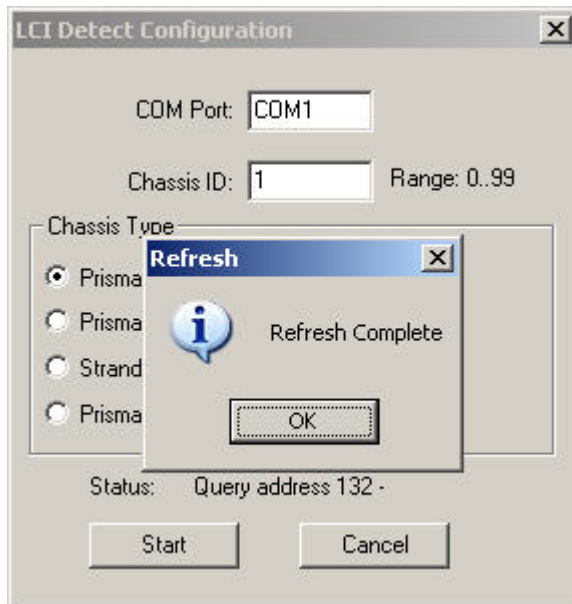

- 3 Click OK to continue with LCI startup.

Result: The main LCI window appears as shown in the example below.

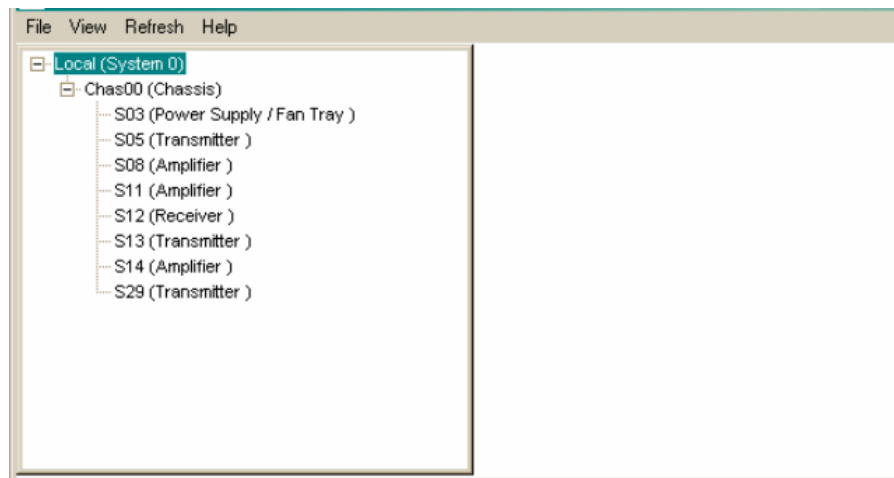

LCI Module Tree

Introduction

The LCI main window contains a tree that represents your system in a hierarchical manner.

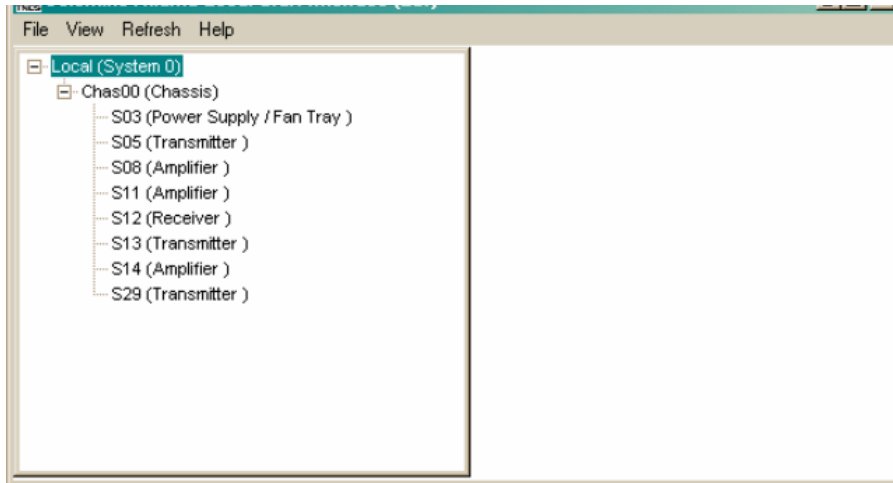

Module Tree

In the graphic above, the module tree represents a computer connected to a chassis that contains ten modules. The three tree levels are described in the following table.

Module Tree Level	Description
Local (System 0)	Computer being used
Chass00 (Chassis)	Chassis the computer is connected to
Sxx (Module name)	Module(s) located within the chassis. Each module is of the format <i>chassis slot location (module name)</i> . Slot location is from 17-32 if the module is located at the lower slot of the host module. The slot number will be the regular upper slot number plus 16.

Accessing the Module Detail Information

The Module Details window displays information about module parameters, alarms, and status. You can access this window from the module tree using any of these methods:

- Double-click the chassis and select the module in the graphic that displays.
- Right-click the chassis and select **Open** from the menu that displays.
- Double-click the module.
- Right-click the module and select **Details** from the menu that displays.

Note: Although you can use the method most convenient for you, the procedures throughout this chapter are described using the right-click module technique.

Module Details Window

Present Value	Present Status	Nominal Value	Minor Alarm Low Limit	Minor Alarm High Limit	Major Alarm Low Limit	Major Alarm High Limit	
40.6	Normal	40.0	-5	5	-15	15	deg-C
69.0	Normal	70.0	-10	10	-20	20	mA
0.0	Normal	0.0	-5.0	5.0	-1000	7.5	dB
4.4	Normal	4.4	-0.5	0.5	-1.0	1.0	dBm

Parameters

Present Value	Present Status	Nominal Value	Minor Alarm Low Limit	Minor Alarm High Limit	Major Alarm Low Limit	Major Alarm High Limit	
40.6	Normal	40.0	-5	5	-15	15	deg-C
69.0	Normal	70.0	-10	10	-20	20	mA
0.0	Normal	0.0	-5.0	5.0	-1000	7.5	dB
4.4	Normal	4.4	-0.5	0.5	-1.0	1.0	dBm

Alarms

Summary Status Normal

Communication Status Normal

Laser Enable Status Normal

CW Mode Status Normal

Power Supply Status Normal

Controls

Enable Laser On

CW Mode Off

Low RF Alarm Inhibit Off

Master Master

RF Drive Level 0.0 dB

AGC Off

Properties

Devtype Revision 1.02

Name S29

Graphic

Service Name

Symbol

Device Location

Alias

Notify Set A

Notify Set B

M&C Scan On-Scan

Maintenance Mode Normal

Poll Counter 1444

Script

Comm Alarm Threshold 1

Comm Quality %

Address 29

Port COM1

Description 1310nm High Density Transmitter

Software Revision 1.01

Script Version

Serial Number ABCDEFGK

Time Of Service 4 Hrs

Day Code A05

Module Type 1020

Status

Module Temperature 29.2 deg-C

TEC Current 88.2 mA

Laser RF Drive 1.0 dB

To Access the Module Details, Double-Click the Chassis

- 1 Double-click the chassis.

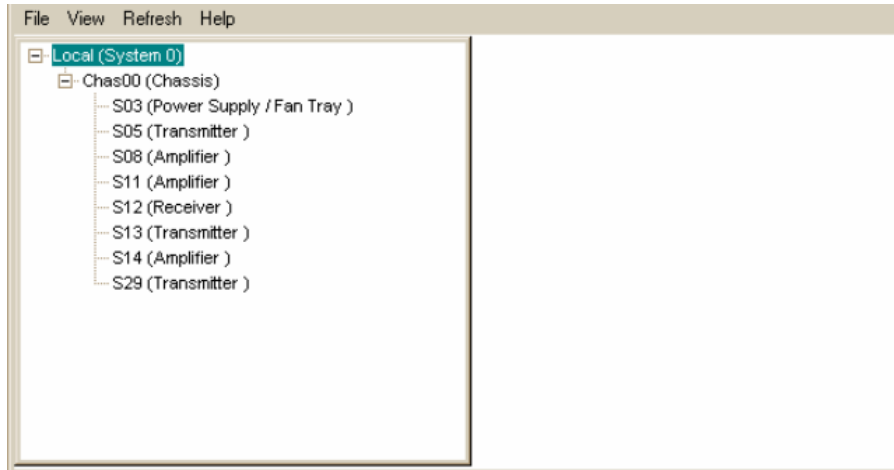

Result: A graphic representation of the chassis appears.

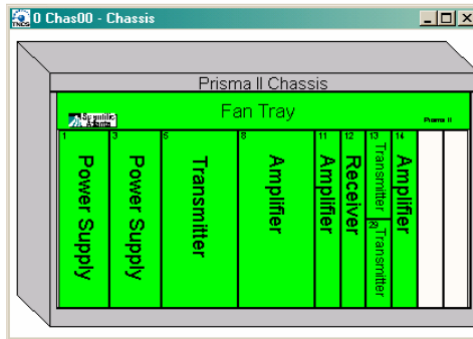

- 2 Double-click the module whose information you want to view or configure.

Result: The Module Details window appears.

1310nm High Density Transmitter

Parameters

	Present Value	Present Status	Nominal Value	Minor-Alarm Low-Limit	Minor-Alarm High-Limit	Major-Alarm Low-Limit	Major-Alarm High-Limit	
Laser Temperature	40.6	Normal	40.0	-5	5	-15	15	deg-C
Laser Bias Current	69.0	Normal	70.0	-10	10	-20	20	mA
RF Input Power	0.0	Normal	0.0	5.0	5.0	1.000	7.5	dB
Optical Output Power	4.4	Normal	4.4	-0.5	0.5	-1.0	1.0	dBm

Alarms

Summary Status Normal
 Communication Status Normal
 Laser Enable Status Normal
 CW Mode Status Normal
 Power Supply Status Normal

Controls

Enable Laser On
 CW Mode Off
 Low RF Alarm Inhibit Off
 Master Master
 RF Drive Level 0.0 dB
 AGC Off

Status

Module Temperature 29.2 deg-C
 TEC Current 88.2 mA
 Laser RF Drive 1.0 dB

Properties

Devtype Revision 1.02
 Name S29
Graphic
 Service Name
 Symbol
 Device Location
 Alias
 Notify Set A
 Notify Set B
 M&C-Scan On-Scan
 Maintenance Mode Normal
 Poll Counter 1444
Script
 Comm Alarm Threshold 1
 Comm Quality %
 Address 29
 Port COM1
 Description 1310nm High Density Transmitter
 Software Revision 1.01
 Script Version
 Serial Number ABCDEFGK
 Time Of Service 4 Hrs
 Day Code A05
 Module Type 1020

- 3 Proceed with viewing or configuring information.

To Access the Module Details, Right-Click the Chassis

- 1 Right-click the chassis, and then click **Open**.

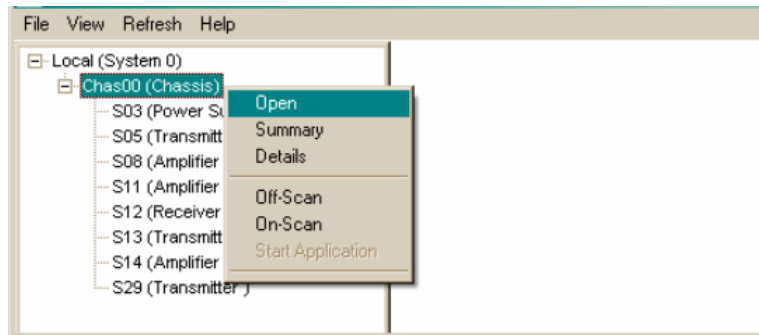

Result: A graphic representation of the chassis appears.

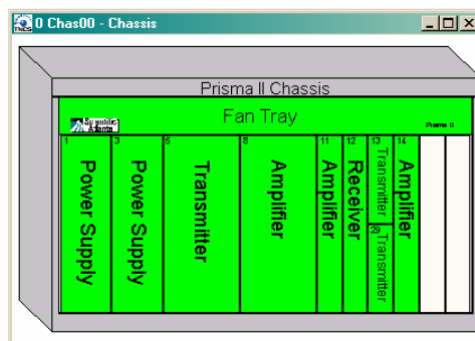

- 2 Double-click the module whose information you want to view or configure.

Result: The Module Details window appears.

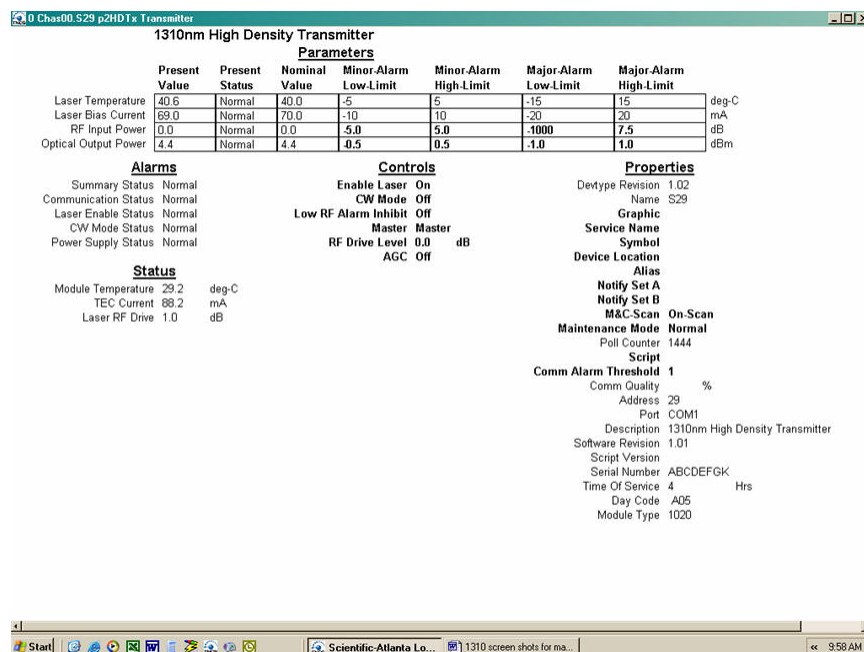

- 3 Proceed with viewing or configuring information.

To Access the Module Details, Double-Click the Module

- 1 Double-click the module.



Result: The Module Details window appears.

The screenshot shows the '1310nm High Density Transmitter' module details window. The window title is '0 Chas00.S29 p2HD1x Transmitter'. The main content is organized into several sections:

Parameters								
	Present Value	Present Status	Nominal Value	Minor-Alarm Low-Limit	Minor-Alarm High-Limit	Major-Alarm Low-Limit	Major-Alarm High-Limit	
Laser Temperature	40.6	Normal	40.0	-5	5	-15	15	deg-C
Laser Bias Current	69.0	Normal	70.0	-10	10	-20	20	mA
RF Input Power	0.0	Normal	0.0	-5.0	5.0	-1.000	7.5	dB
Optical Output Power	4.4	Normal	4.4	-0.5	0.5	-1.0	1.0	dBm

Alarms

- Summary Status: Normal
- Communication Status: Normal
- Laser Enable Status: Normal
- CW Mode Status: Normal
- Power Supply Status: Normal

Status

- Module Temperature: 29.2 deg-C
- TEC Current: 88.2 mA
- Laser RF Drive: 1.0 dB

Controls

- Enable Laser: On
- CW Mode: Off
- Low RF Alarm Inhibit: Off
- Master: Master
- RF Drive Level: 0.0 dB
- AGC: Off

Properties

- Devtype Revision: 1.02
- Name: S29
- Graphic: Graphic
- Service Name: Service Name
- Symbol: Symbol
- Device Location: Device Location
- Alias: Alias
- Notify Set A: Notify Set A
- Notify Set B: Notify Set B
- M&C Scan: On-Scan
- Maintenance Mode: Normal
- Poll Counter: 1444
- Script: Script
- Comm Alarm Threshold: 1
- Comm Quality: %
- Address: 29
- Port: COM1
- Description: 1310nm High Density Transmitter
- Software Revision: 1.01
- Script Version: Script Version
- Serial Number: ABCDEFGK
- Time Of Service: 4 Hrs
- Day Code: AD5
- Module Type: 1020

- 2 Proceed with viewing or configuring information.

To Access the Module Details, Right-Click the Module

- 1 Right-click the module, and then click **Details**.

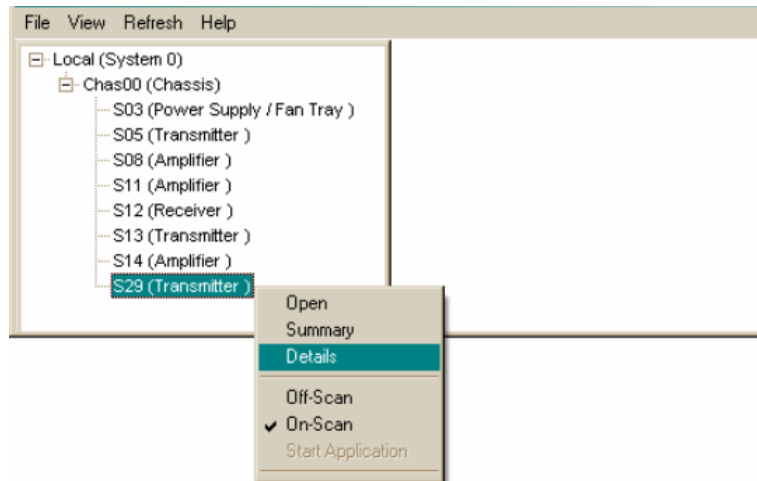

Result: The Module Details window appears.

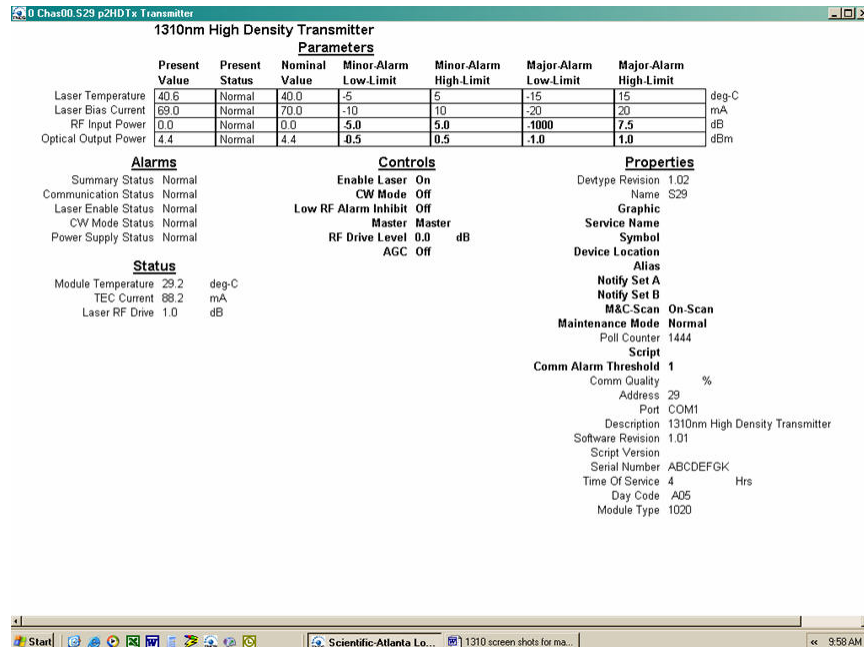

- 2 Proceed with viewing or configuring information.

Checking the Operating Status

To Check the Operating Status using LCI

Using the LCI, you can check the status of all operating parameters of this module.

- 1 In the module tree, right-click the module, and then click **Details**.

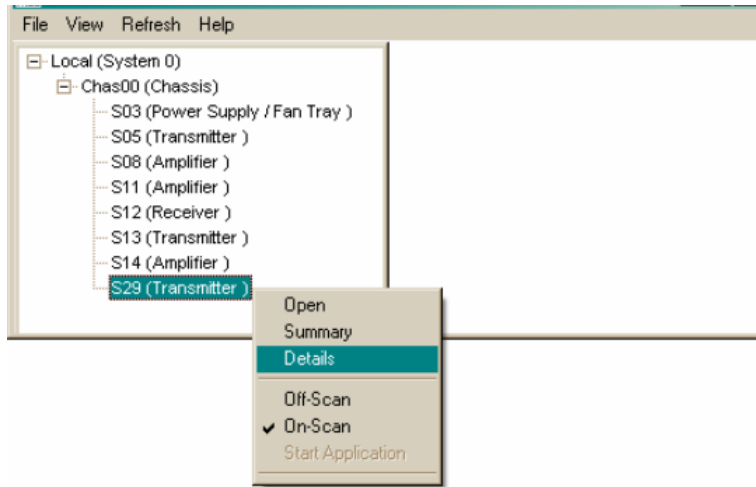

Result: The Module Details window appears. The monitored parameters are displayed under **Parameters** and **Status**.

The screenshot shows the '1310nm High Density Transmitter' details window. It contains several sections:

- Parameters:** A table with columns: Present Value, Present Status, Nominal Value, Minor-Alarm Low-Limit, Minor-Alarm High-Limit, Major-Alarm Low-Limit, Major-Alarm High-Limit.

	Present Value	Present Status	Nominal Value	Minor-Alarm Low-Limit	Minor-Alarm High-Limit	Major-Alarm Low-Limit	Major-Alarm High-Limit	
Laser Temperature	40.6	Normal	40.0	-5	5	-15	15	deg-C
Laser Bias Current	69.0	Normal	70.0	-10	10	-20	20	mA
RF Input Power	0.0	Normal	0.0	-5.0	5.0	-1000	7.5	dB
Optical Output Power	4.4	Normal	4.4	-0.5	0.5	-1.0	1.0	dBm
- Alarms:** Summary Status Normal, Communication Status Normal, Laser Enable Status Normal, CW Mode Status Normal, Power Supply Status Normal.
- Controls:** Enable Laser On, CW Mode Off, Low RF Alarm Inhibit Off, Master Master, RF Drive Level 0.0 dB, AGC Off.
- Properties:** Devtype Revision 1.02, Name S29, Service Name, Symbol, Device Location, Alias, Notify Set A, Notify Set B, M&C-Scan On-Scan, Maintenance Mode Normal, Poll Counter 1444, Script, Comm Alarm Threshold 1, Comm Quality %, Address 29, Port COM1, Description 1310nm High Density Transmitter, Software Revision 1.01, Script Version, Serial Number ABCDEFGK, Time Of Service 4 Hrs, Day Code A05, Module Type 1020.

2 Check the operating parameters.

Note: For details on all operating status parameters, see *Module Parameter Descriptions* (on page 105).

Configuring the Module using LCI

To Configure Parameters using LCI

Using LCI, you can configure the parameters of this module.

- 1 In the module tree, right-click the module, and then click **Details**.

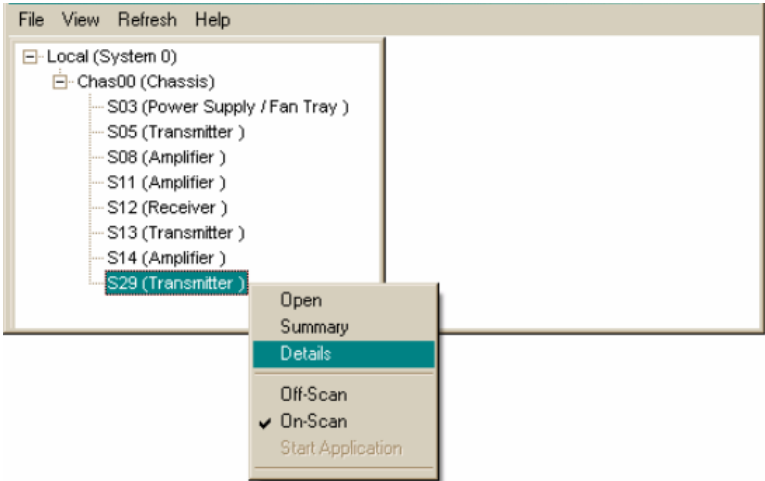

Result: The Module Details window appears.

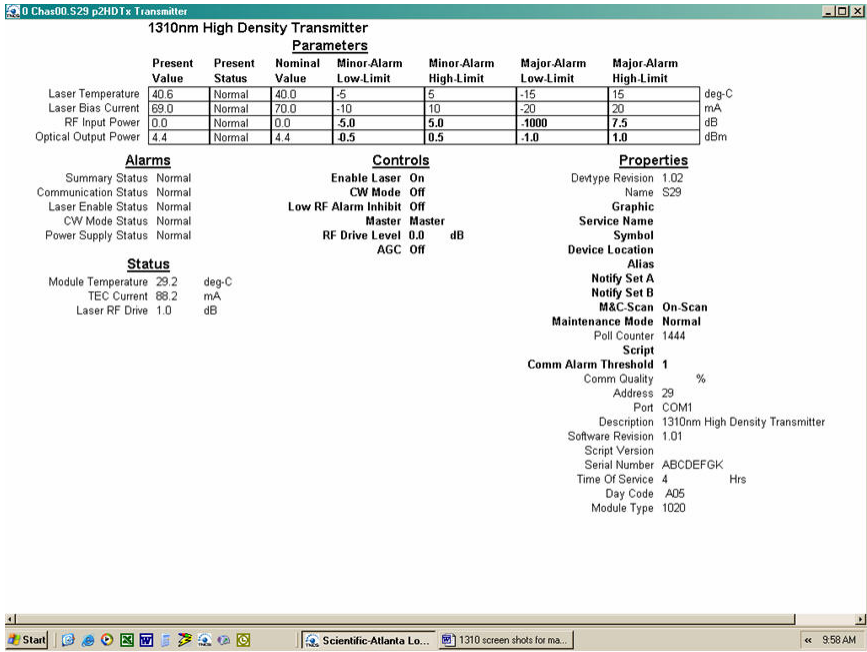

- 2 Under **Controls**, double-click the parameter you want to configure.

Result: The Change Value dialog box appears. This example shows the dialog box for the Enable Laser parameter.

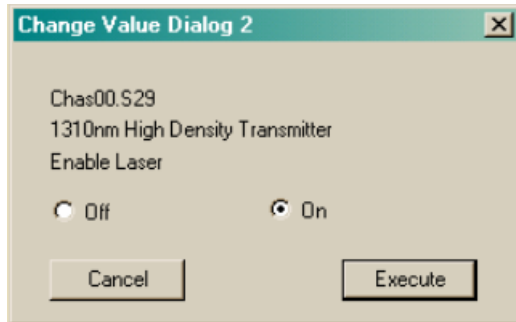

- 3 Depending on the parameter you chose, select or type a new value.
- 4 Click **Execute**.

Result: The new value appears next to the parameter.

Note: For details on all configurable parameters, see *Module Parameter Descriptions* (on page 105).

Checking the Module Alarms using LCI

Using LCI, you can check the alarm status of various parameters. Alarms that you can check are listed below.

Alarms limits fall into one of the following categories.

- Major low
- Minor low
- Minor high
- Major high

To Check Alarms using LCI

Right-click the module, and then click **Details**.

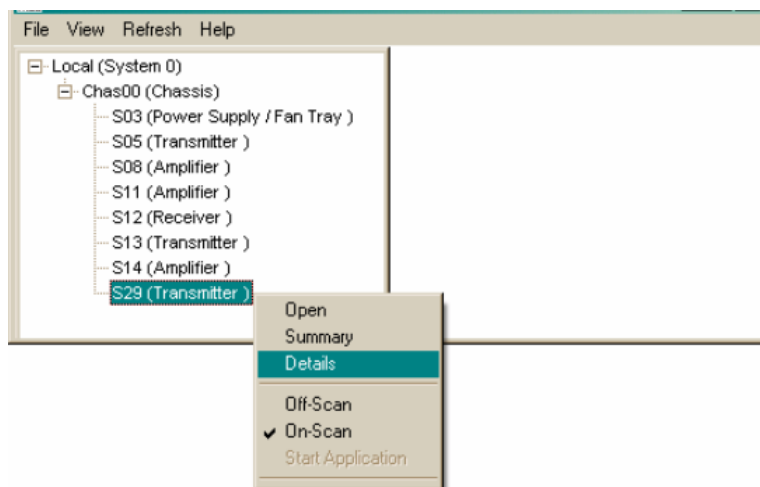

Result: The Module Details window appears. The alarms are shown under **Parameters and Alarms**.

1310nm High Density Transmitter

Parameters

	Present Value	Present Status	Nominal Value	Minor Alarm Low Limit	Minor Alarm High Limit	Major Alarm Low Limit	Major Alarm High Limit	
Laser Temperature	40.6	Normal	40.0	-5	5	-15	15	deg-C
Laser Bias Current	69.0	Normal	70.0	-10	10	-20	20	mA
RF Input Power	0.0	Normal	0.0	-5.0	5.0	-1000	7.5	dB
Optical Output Power	4.4	Normal	4.4	-0.5	0.5	-1.0	1.0	dBm

Alarms

Summary Status Normal
 Communication Status Normal
 Laser Enable Status Normal
 CW Mode Status Normal
 Power Supply Status Normal

Status

Module Temperature 29.2 deg-C
 TEC Current 88.2 mA
 Laser RF Drive 1.0 dB

Controls

Enable Laser On
 CW Mode Off
 Low RF Alarm Inhibit Off
 Master Master
 RF Drive Level 0.0 dB
 AGC Off

Properties

Devtype Revision 1.02
 Name S29
Graphic
 Service Name
 Symbol
 Device Location
 Alias
 Notify Set A
 Notify Set B
 M&C-Scan On-Scan
 Maintenance Mode Normal
 Poll Counter 1444
 Script
 Comm Alarm Threshold 1 %
 Comm Quality %
 Address 29
 Port COM1
 Description 1310nm High Density Transmitter
 Software Revision 1.01
 Script Version
 Serial Number ABCDEFGK
 Time Of Service 4 Hrs
 Day Code A05
 Module Type 1020

Note: For details on all alarm parameters, see *Module Parameter Descriptions* (on page 105).

Modifying Module Alarm Limits using LCI

To Modify Alarm Limits using LCI

Using LCI, you can modify alarm limits for several parameters. Parameters whose alarm limits you can change are listed below.

- 1 In the module tree, right-click the module, and then click **Details**.

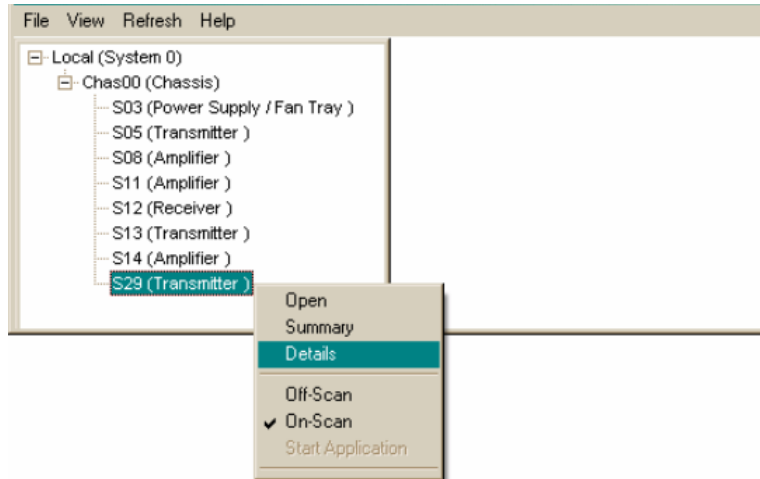

Result: The Module Details window appears. The alarm limits are shown under **Parameters**.

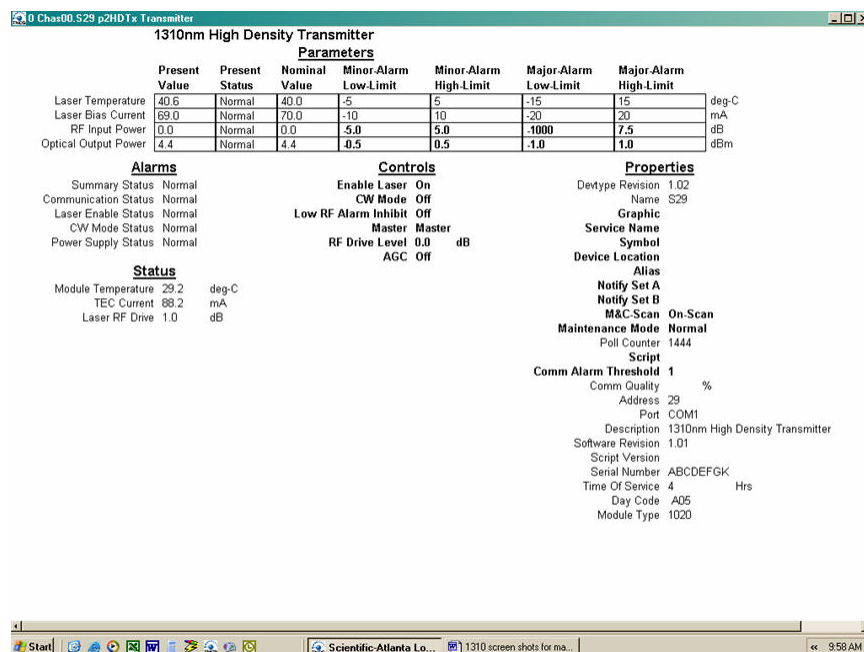

- 2 Double-click the limit you want to change.

Result: The Change Value dialog box appears. This example shows the dialog box for the Optical Output Minor High Limit parameter.

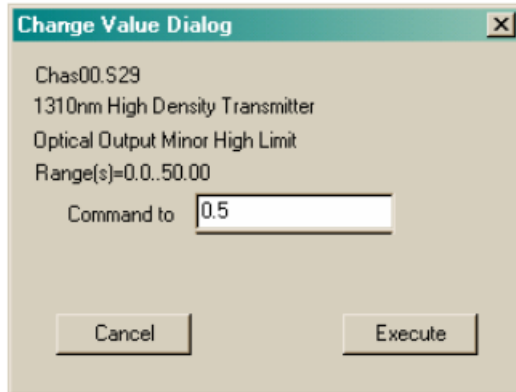

- 3 In the **Command to** box, type the value to use for the limit.
- 4 Click **Execute**.

Result: The new value appears in the alarm limit column.

Note: For details on all alarm limits, see *Module Parameter Descriptions* (on page 105).

Checking Manufacturing Data using LCI

To Check Manufacturing Data using LCI

Using LCI, you can check the manufacturing data of the module.

- 1 In the module tree, right-click the module, and then click **Details**.

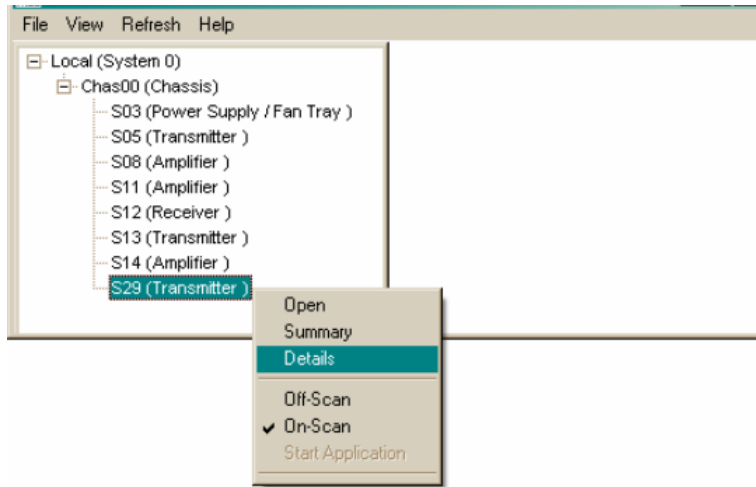

Result: The Module Details window appears. The manufacturing data is displayed under **Properties**.

The screenshot shows the '1310nm High Density Transmitter' details window. It contains several sections: Parameters, Alarms, Status, Controls, and Properties.

Parameters								
	Present Value	Present Status	Nominal Value	Minor-Alarm Low-Limit	Minor-Alarm High-Limit	Major-Alarm Low-Limit	Major-Alarm High-Limit	
Laser Temperature	40.6	Normal	40.0	-5	5	-15	15	deg-C
Laser Bias Current	69.0	Normal	70.0	-10	10	-20	20	mA
RF Input Power	0.0	Normal	0.0	-5.0	5.0	-1000	7.5	dB
Optical Output Power	4.4	Normal	4.4	-0.5	0.5	-1.0	1.0	dBm

Alarms

- Summary Status: Normal
- Communication Status: Normal
- Laser Enable Status: Normal
- CW Mode Status: Normal
- Power Supply Status: Normal

Status

- Module Temperature: 29.2 deg-C
- TEC Current: 88.2 mA
- Laser RF Drive: 1.0 dB

Controls

- Enable Laser: On
- CW Mode: Off
- Low RF Alarm Inhibit: Off
- Master: Master
- RF Drive Level: 0.0 dB
- AGC: Off

Properties

- Devtype Revision: 1.02
- Name: S29
- Graphic: [None]
- Service Name: [None]
- Symbol: [None]
- Device Location: [None]
- Alias: [None]
- Notify Set A: [None]
- Notify Set B: [None]
- M&C-Scan: On-Scan
- Maintenance Mode: Normal
- Poll Counter: 1444
- Script: [None]
- Comm Alarm Threshold: 1
- Comm Quality: [None] %
- Address: 29
- Port: COM1
- Description: 1310nm High Density Transmitter
- Software Revision: 1.01
- Script Version: [None]
- Serial Number: ABCDEFGK
- Time Of Service: 4 Hrs
- Day Code: A05
- Module Type: 1020

2 Proceed with viewing the manufacturing data.

Note: For details on all manufacturing data parameters, see *Module Parameter Descriptions* (on page 105).

5

Maintenance and Troubleshooting

Introduction

This chapter describes the maintenance guidelines and troubleshooting procedures for this Prisma II module.

Qualified Personnel

Only appropriately qualified and skilled personnel should attempt to install, operate, maintain, and service this product.



WARNING:

Allow only qualified and skilled personnel to install, operate, maintain, and service this product. Otherwise, personal injury or equipment damage may occur.

In This Chapter

- Maintenance 100
- General Troubleshooting Information 101
- Troubleshooting Alarm Conditions 102

Maintenance

The following maintenance is recommended to ensure optimal performance.

Frequency	Maintenance Required
Yearly	<ul style="list-style-type: none"> ■ Check all parameters and test points. ■ Record data. ■ Make adjustments as needed. ■ Make sure all cables are mated properly. ■ Inspect cables for stress and chafing. ■ Make sure all retaining screws are tight. ■ Replace chassis air filter. Depending on office environment cleanliness/filtration, the chassis air filter may require more frequent servicing.
When needed	Carefully clean the module with a soft cloth that is dampened with mild detergent.

Maintenance Record

It may be helpful to establish a maintenance record or log for this equipment. You may want to record laser power level, laser temperature readings, laser bias current, or power supply voltages, as well as the filter change dates.

Large variations in any of the parameters above should be investigated prior to failure.

General Troubleshooting Information

This troubleshooting information describes the most common alarms and gives typical symptoms, causes, and items to check before contacting Customer Service.

Equipment Needed

You may need the following equipment to troubleshoot these modules.

- Digital voltmeter
- Fiber connector cleaning materials

Additional Assistance

If you need additional assistance contact Cisco Services.

Troubleshooting

Refer to *Troubleshooting Alarm Conditions* (on page 102) to identify and correct faults.



WARNING:

Avoid electric shock and damage to this product! Do not open the enclosure of this product. There are no user-serviceable parts inside. Refer servicing to qualified and skilled personnel.

Troubleshooting Alarm Conditions

Module Alarm Conditions

If the red ALARM indicator is illuminated or is blinking, check the display on the front panel to determine the cause of the alarm.

Alarm	Function	Possible Causes	Possible Solutions
LasBias	Laser Bias Current Failed	Automatic power control circuit failure.	Contact Cisco Services for assistance.
LasTemp	Laser Temperature High or Low	<ul style="list-style-type: none"> ■ Laser temperature out of specification. Laser could be faulty. ■ Chassis air filter requires changing. 	Contact Cisco Services for assistance.
ModTemp	Module Temperature High or Low	<p>Ambient temperature is too high due to:</p> <ul style="list-style-type: none"> ■ A failure in the building air conditioning system. ■ Airflow through the rack has been restricted or cut off. ■ Prisma chassis cooling fans are not operating properly. 	<p>Ensure the airflow system has not been damaged or removed. Repair or replace fan tray as needed.</p> <p>To troubleshoot the chassis cooling fans, refer to <i>Prisma II Chassis Installation and Operation Guide</i>, part number 713375.</p>
InRF	RF Input Power High or Low	<ul style="list-style-type: none"> ■ RF source not transmitting. ■ Faulty RF cables or connections. 	Check RF source and cables and call connections.
OutPwr	Optical Output Power High or Low	Laser could be faulty.	Contact Cisco Services for assistance.

6

Customer Information

If You Have Questions

If you have technical questions, call Cisco Services for assistance. Follow the menu options to speak with a service engineer.

Access your company's extranet site to view or order additional technical publications. For accessing instructions, contact the representative who handles your account. Check your extranet site often as the information is updated frequently.

A

Module Parameter Descriptions

Introduction

This appendix provides control, alarm, monitor, and manufacturing data parameters for this equipment.

In This Appendix

- High Density Transmitter Parameters 106

High Density Transmitter Parameters

Operating Status Parameters

Parameter Name (LCI)	ICIM Abbreviation	Function	Typical Value
Optical Output Power	OutPwr	Displays optical output power.	4.4 dBm
Laser Bias Current	LasBias	Displays laser bias current.	69 mA
RF Input Power	InRF	Displays RF input level.	0.0 dB
Module Temperature	ModTemp	Displays module temperature.	40.6 °C
TEC Current	TecCur	Displays laser thermoelectric cooler current.	88.2 mA
Laser Temperature	LasTemp	Displays laser temperature.	29.2 °C
Laser RF Drive	LasRF	Indicates RF drive level at laser input reference to nominal setup.	1.0 dB
Enable Laser	Enable	Status of laser (On or Off).	-
CW Mode	CwMode	Status of continuous wave mode operation (On or Off).	-
Low RF Alarm Inhibit	LoRFInh	Status of Low RF alarm (On or Off).	-
Master	Master	Indicates Master or Slave mode operation.	-
RF Drive Level	RFDrive	Displays RF drive level relative to nominal setup.	0.0 dB
AGC	AGC	Status of automatic gain control (On or Off).	-

Note: Monitored values may vary from module to module. The values shown above are examples only.

Configurable Parameters

Parameter Name (LCI)	ICIM Abbreviation	Description	Values	Default
Enable Laser	Enable	Enables or disables amplifier operation, i.e., turns the laser on or off.	ON (1) = Enabled OFF (0) = Disabled	OFF (0)
CW Mode	CwMode	Automatically adjusts the displayed RF input level by subtracting 3 dB when CW mode is on.	ON (1) = Enabled OFF (0) = Disabled	OFF (0)
Low RF Alarm Inhibit	LoRFInh	Enables or disables the "RF input low" alarm.	ON (1) = Alarm Enabled OFF (0) = Alarm Disabled	ON (1)
Master	Master	Configures the module as master or slave: <ul style="list-style-type: none"> ■ If set to Master, the transmitter is controlled only by the Enable control above. ■ If set to Slave, the transmitter is controlled by a combination of Enable and the external input CNT_IN_1. 	ON (1) = Master OFF (0) = Slave	ON (1)
RF Drive Level	RFDrive	Sets the relative RF drive level into the transmitter.	-5.0 dB to +3.0 dB in 0.5 dB steps	0.0 dB
AGC	AGC	Turns automatic gain control on or off.	ON (1) OFF (0)	OFF (0)

Alarm Data Parameters

Parameter Name (LCI)	ICIM Abbrev.	Nominal Value	Major Low Limit	Minor Low Limit	Minor High Limit	Major High Limit	Hys-teresis	Operating Range
RF Input Power *	InRF	0.0 dB	-1000 dB	-5.0 dB	5.0 dB	7.5 dB	1.0	-4.5 dB to +3.0 dB
Optical Output Power *	OutPwr	4.4 dBm	-1.0 dBm	-0.5 dBm	0.5 dBm	1.0 dBm	0.1	±0.5 dB of nominal
CW Mode Status	CwMode	-	-	-	-	-	-	OK or Fault
Laser Temperature *	LasTemp	40.0°C	-15.0°C	-5.0°C	5.0°C	15.0°C	1.0	20°C to 30°C
Laser Bias Current *	LasBias	70.0 mA	-20.0 mA	-10.0 mA	10.0 mA	20.0 mA	0.001	50 mA to 100 mA
Laser Enable Status	Enable	-	-	-	-	-	-	OK or Fault
Power Supply Status	PsOk	-	-	-	-	-	-	OK or Fault

* Alarm limit values for this parameter are relative to the nominal alarm value.

Manufacturing Data Parameter Examples

Parameter Name (LCI)	ICIM Abbreviation	Typical Values
Description	Module	1310 nm High Density Transmitter
Software Revision	Sw Ver	1.55
Script Version	Script Ver	26
Serial Number	Serial #	AACUGTU
Time of Service	In Service Hours (initial value)	0
-	Spec Data	Special data
Day Code	Date Code	B01
Module Type	Module Type	1020
-	Restore Factory Defaults	Restores the module factory default configuration settings.

Note: These values may vary from module to module. The values shown above are examples only.

Glossary

ac, AC

alternating current. An electric current that reverses its direction at regularly recurring intervals.

AGC

automatic gain control. A process or means by which gain is automatically adjusted in a specified manner as a function of input level or other specified parameters.

CAN

cancel. The cancel character.

dc, DC

direct current. An electric current flowing in one direction only and substantially constant in value.

DFB laser

distributed feedback laser. An injection laser diode that has a Bragg reflection grating in the active region in order to suppress multiple longitudinal modes and enhance a single longitudinal mode.

DRR

dual reverse receiver.

EDFA

erbium doped fiber amplifier. Optical fibers doped with the rare earth element, erbium, which can amplify light in the 1550 nm region when pumped by an external light source.

EIA

Electronic Industries Association. A United States association that provides standards for use between manufacturers and purchasers of electronic products.

EMC

electromagnetic compatibility. A measure of equipment tolerance to external electromagnetic

Glossary

fields.

EMT

externally-modulated transmitter.

ESD

electrostatic discharge. Discharge of stored static electricity that can damage electronic equipment and impair electrical circuitry, resulting in complete or intermittent failures.

HD

high density.

I/O

input/output.

ICIM

intelligent communications interface module.

IP

Internet protocol. A standard that was originally developed by the United States Department of Defense to support the internetworking of dissimilar computers across a network. IP is perhaps the most important of the protocols on which the Internet is based. It is the standard that describes software that keeps track of the internetwork addresses for different nodes, routes, and outgoing/incoming messages on a network. Some examples of IP applications include email, chat, and Web browsers.

LCD

liquid crystal display. A display medium made of liquid crystal. Liquid crystal's reflectance changes when an electric field is applied. Commonly used in monitors, televisions, cell phones, digital watches, etc.

LCI

local craft interface.

LED

light-emitting diode. An electronic device that lights up when electricity passes through it.

MIB

management information base. SNMP collects management information from devices on the network and records the information in a management information base. The MIB

information includes device features, data throughput statistics, traffic overloads, and errors.

nm

nanometer. One billionth of a meter.

NMS

network management system. A software system designed specifically to monitor a network and to facilitate troubleshooting.

OMI

optical modulation index.

PLL

phase lock loop. An electronic servo system controlling an oscillator to maintain a constant phase angle relative to a reference signal.

QAM

quadrature amplitude modulation. A phase modulation technique for representing digital information and transmitting that data with minimal bandwidth. Both phase and amplitude of carrier waves are altered to represent the binary code. By manipulating two factors, more discrete digital states are possible and therefore larger binary schemes can be represented.

RF

radio frequency. The frequency in the portion of the electromagnetic spectrum that is above the audio frequencies and below the infrared frequencies, used in radio transmission systems.

RMA

return material authorization. A form used to return products.

RT

remote terminal. Remote equipment of a supervisory system.

RX

receive or receiver.

SBS

stimulated Brillouin scattering. The easiest fiber nonlinearity to trigger. When a powerful lightwave travels through a fiber, it interacts with acoustical vibration modes in the glass. This causes a scattering mechanism to be formed that reflects much of the light back to the source.

Glossary

SMC

status monitoring and control. The process by which the operation, configuration, and performance of individual elements in a network or system are monitored and controlled from a central location.

SNMP

simple network management protocol. A protocol that governs network management and the monitoring of network devices and their functions.

TEC

thermoelectric cooler. A device used to dissipate heat in electronic assemblies.

TNCS

Transmission Network Control System. A Cisco application that allows status monitoring and control of all transmission equipment located in headends and hubs plus optical nodes, power supplies, and amplifiers in the outside plant. TNCS provides access to and information on the entire network in an easy to understand, topology driven, graphical user display.

torque

A force that produces rotation or torsion. Usually expressed in lb-ft (pound-feet) or N-m (Newton-meters). The application of one pound of force on a lever at a point on the lever that is one foot from the pivot point would produce 1 lb-ft of torque.

TX

transmit or transmitter.

Index

A

- ac, AC • 111
- Access Requirements • 13
- Accessing the Module Detail Information • 84
- Additional Assistance • 101
- Adjusting Alarm Thresholds • 71
- AGC • 111
- Alarm Data Parameters • 108
- Alarm Threshold Menus • 58
- ALARMS IN and ALARMS OUT Connector Illustration • 32
- ALARMS IN and ALARMS OUT Connectors • 31
- ALARMS Menus • 57

B

- Back Panel Connectors • 6
- Basic SNMP Setup • 62
- Boot Dialog for ICIM/SNMP Configuration • 68

C

- Cable Kits for Connecting a Chassis to the TNCS Server • 29
- Cable Requirements • 75
- CAN • 111
- Chassis-to-Chassis ICIM Connections • 27
- Checking Manufacturing Data using LCI • 97
- Checking Manufacturing Data using the ICIM • 59
- Checking Module Alarms using the ICIM • 56
- Checking the Module Alarms using LCI • 93
- Checking the Operating Status • 89
- Checking the Operating Status using the ICIM • 52
- Community Names • 65
- Computer Requirements • 75
- CONFIG Menus • 54
- Configurable Parameters • 107
- Configuration and Monitoring Methods • 9
- Configuration Complete • 61
- Configuration Summary • 10

- Configuring the Module using LCI • 91
- Configuring the Module using the ICIM • 54
- Connecting a Chassis to the TNCS Server • 29
- Connecting Optical Cables • 23
- Connecting the ICIM to Additional Chassis • 27
- Connecting the RF Cables to the Chassis • 17
- Connecting Your Computer to the Chassis • 79, 81
- Customer Information • 103
- Customer Support Information • 101

D

- dc, DC • 111
- Default Community Strings • 65
- DFB laser • 111
- DRR • 111

E

- EDFA • 111
- EIA • 111
- EMC • 111
- EMT • 112
- Equipment and Tools Needed • 12
- Equipment Needed • 101
- Equipment Rack • 13
- ESD • 112
- Expired Password or Inactive Password Messages • 42, 43
- External Alarms Connections • 31

F

- Fiber Fish Tool • 23
- Fiber Fish Tool Hook • 23
- Front-Access Chassis - Front Panel Illustration • 15

G

- General Troubleshooting Information • 101

H

- HD • 112
- High Density Transmitter Block Diagram • 4

- High Density Transmitter Description • 3
- High Density Transmitter Features • 3
- High Density Transmitter Front and Back Panel • 5
- High Density Transmitter Front Panel Features • 5
- High Density Transmitter Illustration • 5
- High Density Transmitter Operation • 3
- High Density Transmitter Optical Output • 4
- High Density Transmitter Parameters • 106
- Host Module • 7
- Host Module Back Panel Connectors • 8
- Host Module Features • 7
- Host Module Illustration • 7

I

- I/O • 112
- ICIM • 112
- ICIM Block Diagram • 38
- ICIM Function • 37
- ICIM IN and ICIM OUT Cables • 27
- ICIM IN and ICIM OUT Connectors • 27
- ICIM Introduction • 37
- ICIM Keypad • 41
- ICIM LCD • 40
- ICIM MAIN Menu • 47
- ICIM MAIN Menu Illustration • 40, 48
- ICIM Password • 42
- ICIM2 Front Panel • 39
- ICIM2 Front Panel Features • 40
- ICIM2 Illustration (Front Panel) • 39
- Installing LCI • 76
- Installing the Module in the Chassis • 19
- IP • 112

L

- Laser Warning • 4, 37, 74
- LCD • 112
- LCI • 112
- LCI Function • 74
- LCI Introduction • 74
- LCI Module Tree • 83
- LED • 112

M

- Maintenance • 100
- Maintenance and Troubleshooting • 99
- Maintenance Record • 100
- Manufacturing Data Parameter Examples • 109
- Master/Slave Illustration • 32

- Master/Slave Operation • 31
- MFG. DATA Menus • 60
- MIB • 112
- Modifying Module Alarm Limits using LCI • 95
- Module Alarm Conditions • 102
- Module Configuration • 9
- Module Details Window • 84
- Module Installation • 11
- Module Introduction • 1
- Module Tree • 83

N

- New SNMP Variables • 66
- nm • 113
- NMS • 113

O

- OMI • 113
- Operating Environment • 13
- Operating Status Parameters • 106
- Operating the ICIM • 47
- Operation using ICIM • 9, 10, 35
- Operation using LCI • 9, 10, 73
- Optical Connector Cleaning Overview • 24

P

- Password Protection System • 42
- PLL • 113
- Power Requirements • 13
- Preparing for Installation • 12
- Previous IP Address • 67
- Prisma II Chassis Style • 14
- Prisma II ICIM Menu • 48
- Prisma II MAIN Menu and ICIM Menu Structure • 49
- Prisma II Redundancy Interface Panel Illustrations • 33
- Prisma II Transmitter Module Software Menu Structure • 50
- Prisma II XD Chassis Style • 16

Q

- QAM • 113

R

- Rear-Access Chassis - Front Panel Illustration • 15
- Recommended Equipment • 24
- Redundancy Interface Panel • 33
- RF • 113

S

Saving the Configuration using the ICIM • 61
 SBS • 113
 Setting SNMP Trap Receiver Parameters • 51
 Site Requirements • 13
 SMC • 114
 SNMP • 114
 SNMP Configuration • 62
 SNMP Considerations • 62
 Space Requirements • 14
 Starting LCI Software • 81
 STATUS Menus • 53
 System Requirements • 75

T

Table of Inserted Modules • 66
 Table of Removed Modules • 66
 TEC • 114
 Tips for Optimal Fiber-Optic Connector
 Performance • 24
 TNCS • 114
 To Access the ICIM LCD Contrast • 47
 To Access the Module Details, Double-Click the
 Chassis • 85
 To Access the Module Details, Double-Click the
 Module • 87
 To Access the Module Details, Right-Click the
 Chassis • 86
 To Access the Module Details, Right-Click the
 Module • 88
 To Access the Password Menu • 42, 43, 44
 To Adjust Alarm Thresholds • 71
 To Change Parameters • 70
 To Change the User Password • 44
 To Check Alarms using ICIM • 56
 To Check Alarms using LCI • 93
 To Check Manufacturing Data • 59
 To Check Manufacturing Data using LCI • 97
 To Check the Operating Status using ICIM • 52
 To Check the Operating Status using LCI • 89
 To Clean Optical Connectors • 25
 To Configure Parameters using LCI • 91
 To Configure Parameters using the ICIM • 54
 To Connect a Computer to the Chassis • 79
 To Connect Chassis-to-Chassis ICIM IN and
 ICIM OUT Ports • 28
 To Connect Optical Cables to Module • 26
 To Connect RF Cables for Each Module • 17

To Connect TNCS to the Chassis EM IN Port •
 29
 To Disable the User Password using ICIM • 45
 To Enter the User Password • 42, 43
 To Install the Host Module in the Chassis • 20
 To Install the LCI Software • 76
 To Install the Module in a Prisma II XD Chassis
 • 21
 To Install the Transmitter Modules in the Host
 Module • 19
 To Modify Alarm Limits using LCI • 95
 To Prepare to Change Parameters • 69
 To Pull the Optical Cable to the Module • 23
 To Restart the ICIM by Removing the ICIM • 64
 To Restart the ICIM using ICIM • 70
 To Save the Current Configuration • 61
 To Set Adjustable Alarm Thresholds using the
 ICIM • 57
 To Set Traps for a Specific IP Address using
 P2TrapRecvEntry • 51
 To Set Up the IP Configuration Parameters for
 SNMP Support using ICIM • 62
 To Start LCI Software • 81
 torque • 114
 Troubleshooting • 101
 Troubleshooting Alarm Conditions • 101, 102
 TX • 114

U

Unpacking and Inspecting the Module • 12
 Using the ICIM • 47
 Using TNCS with Multiple Chassis • 30



Cisco Systems, Inc.
5030 Sugarloaf Parkway, Box 465447
Lawrenceville, GA 30042

678 277-1120
800 722-2009
www.cisco.com

This document includes various trademarks of Cisco Systems, Inc. Please see the Notices section of this document for a list of the Cisco Systems, Inc. trademarks used in this document.

Product and service availability are subject to change without notice.

© 2008, 2013 Cisco and/or its affiliates.

All rights reserved.

January 2013 Printed in USA

Part Number 78-4009700-01 Rev E