

Cisco HyperFlex HX245C M6SX All Flash and Hybrid Server Nodes

A printed version of this document is only a copy and not necessarily the latest version. Refer to the following link for the latest released version:

<https://www.cisco.com/c/en/us/products/servers-unified-computing/HX-c-series-rack-servers/datasheet-listing.html>



CONTENTS

OVERVIEW	5
DETAILED VIEWS	8
Chassis Rear View - HXAF245C-M6SX (All Flash)	9
Chassis Front View - HX245C-M6SX (Hybrid)	11
Chassis Rear View - HX245C-M6SX (Hybrid)	12
BASE SERVER STANDARD CAPABILITIES and FEATURES	15
CONFIGURING the SERVER	18
STEP 1 VERIFY SERVER SKU	19
STEP 2 SELECT DEPLOYMENT MODE (OPTIONAL)	20
STEP 3 SELECT RISER CARDS (REQUIRED)	21
STEP 4 SELECT CPU(s)	22
STEP 5 SELECT MEMORY	25
STEP 6 SELECT DRIVE CONTROLLERS	30
Cisco 12G SAS HBA	30
STEP 7 SELECT DRIVES	31
STEP 8 SELECT OPTION CARD(s)	36
STEP 9 ORDER OPTIONAL PCIe OPTION CARD ACCESSORIES	39
STEP 10 ORDER GPU CARDS (OPTIONAL)	42
STEP 11 ORDER POWER SUPPLY	44
STEP 12 SELECT INPUT POWER CORD(s)	45
STEP 13 ORDER TOOL-LESS RAIL KIT AND OPTIONAL REVERSIBLE CABLE MANAGEMENT ARM	49
STEP 14 ORDER SECURITY DEVICES (OPTIONAL)	50
STEP 15 ORDER TOOL-LESS RAIL KIT AND OPTIONAL REVERSIBLE CABLE MANAGEMENT ARM	51
STEP 16 ORDER SECURITY DEVICES (OPTIONAL)	52
STEP 17 SELECT LOCKING SECURITY BEZEL (OPTIONAL)	53
STEP 18 SELECT HYPERVISOR / HOST OPERATING SYSTEM	54
STEP 19 SELECT HYPERFLEX DATA PLATFORM (HXDP) SOFTWARE	55
STEP 20 CISCO INTERSIGHT	56
STEP 21 SELECT SERVICE and SUPPORT LEVEL	57
Unified Computing Warranty, No Contract	57
Smart Net Total Care (SNTC) for Cisco UCS	57
Smart Net Total Care (SNTC) for Cisco UCS Onsite Troubleshooting Service	59
Solution Support (SSPT) for UCS	60
Solution Support for Service Providers	61
Smart Net Total Care for UCS Hardware Only Service	61
Partner Support Service for UCS	62
PSS for UCS Hardware Only	63
Distributor Support Service (DSS)	64
Unified Computing Combined Support Service	65
UCS Drive Retention Service	66
Local Language Technical Support for UCS	66
SUPPLEMENTAL MATERIAL	67
Hyperconverged Systems	67
Chassis	69
Riser Connector Locations on the Motherboard	71
Riser Card Configurations and Options	73
Riser 1A	73
Riser 1B	74
Riser 2A	75

Riser 3A	76
Riser 3B	77
Riser 3C	78
Memory Support for AMD Rome and Milan CPUs	79
Serial Port Details	80
KVM Cable	80
SPARE PARTS	81
REPLACING CPUs and HEATSINKS	91
UPGRADING or REPLACING MEMORY	92
TECHNICAL SPECIFICATIONS	93
Dimensions and Weight	93
Power Specifications	94
Environmental Specifications	99
Extended Operating Temperature Hardware Configuration Limits	101
Compliance Requirements	103

CONTENTS

OVERVIEW

Cisco HyperFlex™ Systems unlock the full potential of hyperconvergence. The systems are based on an end-to-end software-defined infrastructure, combining software-defined computing in the form of Cisco Unified Computing System (Cisco UCS) servers; software-defined storage with the powerful Cisco HX Data Platform and software-defined networking with the Cisco UCS fabric that will integrate smoothly with Cisco Application Centric Infrastructure (Cisco ACI™). Together with a single point of connectivity and hardware management, these technologies deliver a preintegrated and adaptable cluster that is ready to provide a unified pool of resources to power applications as your business needs dictate.

The Cisco HyperFlex HX245C M6SX All Flash and Hybrid Server Nodes extends the capabilities of Cisco's HyperFlex portfolio in a 2U form factor with the addition of the AMD CPUs, 16 DIMM slots per CPU for 3200-MHz DDR4 DIMMs with individual DIMM capacity points up to 256 GB. The maximum memory capacity for 2 CPUs is 8 TB (for 32 x 256 GB DDR4 DIMMs).

There are two servers to choose from:

- **HXAF245C-M6SX (All Flash)** (see [Figure 1 on page 7](#)):
 - Up to 24 front SFF SAS/SATA SSDs and NVMe caching drives.
 - I/O centric option provides up to 8 PCIe slots using all three rear risers.
 - Storage-centric option provides 3 PCIe slots using slots in one of the rear risers and two rear risers with a total of up to 4 SFF drives.
- **HX245C-M6SX (Hybrid)** (see [Figure 1 on page 7](#)):
 - Up to 24 front SFF SAS/SATA HDDs and SSDs drives.
 - I/O centric option provides up to 8 PCIe slots using all three rear risers
 - Storage-centric option provides 3 PCIe slots using slots in one of the rear risers and two rear risers with a total of up to 4 SFF drives

The server provides one or two internal slots (depending on the server type) for the following:

- Two slots for Cisco 12G SAS pass-through HBAs. Each HBA controls up to 16 SAS/SATA drives



NOTE: PCIe drives are controlled directly from the CPUs.

The Cisco HyperFlex HX245C M6SX All Flash and Hybrid Server Nodes has a single 1 GbE management port. A modular LAN on motherboard (mLOM)/OCP 3.0 module provides up to two 100 GbE ports. A connector on the front of the chassis provides KVM functionality.

Deployment Options

Starting with HyperFlex 5.0(2a) the following 2 deployment options are supported:

- **HX Data Center with Fabric Interconnect** - This deployment option connects the server to Cisco Fabric Interconnect. The installation for this type of deployment can be done using the standalone installer or from the Intersight.
- **HX Data Center without Fabric Interconnect** - This deployment option allows server nodes to be directly connected to existing switches. The installation for this type of deployment can be done from the Intersight only.

See [Figure 1 on page 7](#) for front and rear views of the Cisco HyperFlex HX245C M6SX All Flash and Hybrid Server Nodes.

Figure 1 Cisco HyperFlex HX245C M6SX All Flash and Hybrid Server Nodes

HXAF245C-M6SX (All Flash)

24 Front drives are SAS/SATA and NVMe mix (up to 4 NVMe drives) and optionally 4 NVMe rear drives

Front View



Rear View (all slots shown unpopulated - see [Figure 3 on page 9](#) for details)

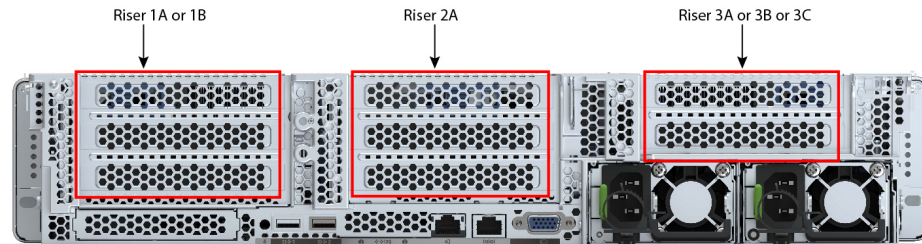

HX245C-M6SX (Hybrid)

24 Front drives are SAS/SATA HDDS & SSDs and optionally 4 SAS/SATA rear drives

Front View (see [Figure 4 on page 11](#) for details)



Rear View (all slots shown unpopulated - see [Figure 5 on page 12](#) for details)

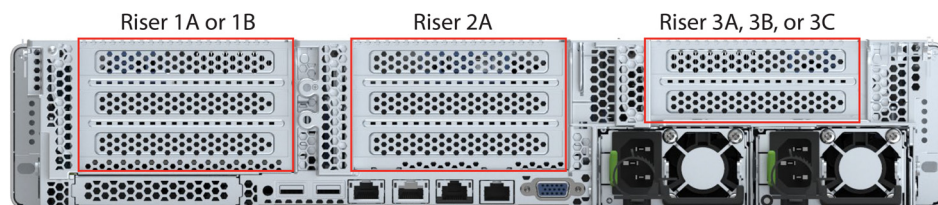

DETAILED VIEWS

Chassis Front View - HXAF245C-M6SX (All Flash)

Figure 2 shows the front View of the HyperFlex HXAF245C M6SX All Flash Server Nodes configured with 24 front drives. The drives can be a mix of SAS/SATA and NVMe (up to 4 NVMe drives) and optionally up to 4 NVMe rear drives.

Figure 2 Chassis Front View (HXAF245C-M6SX)

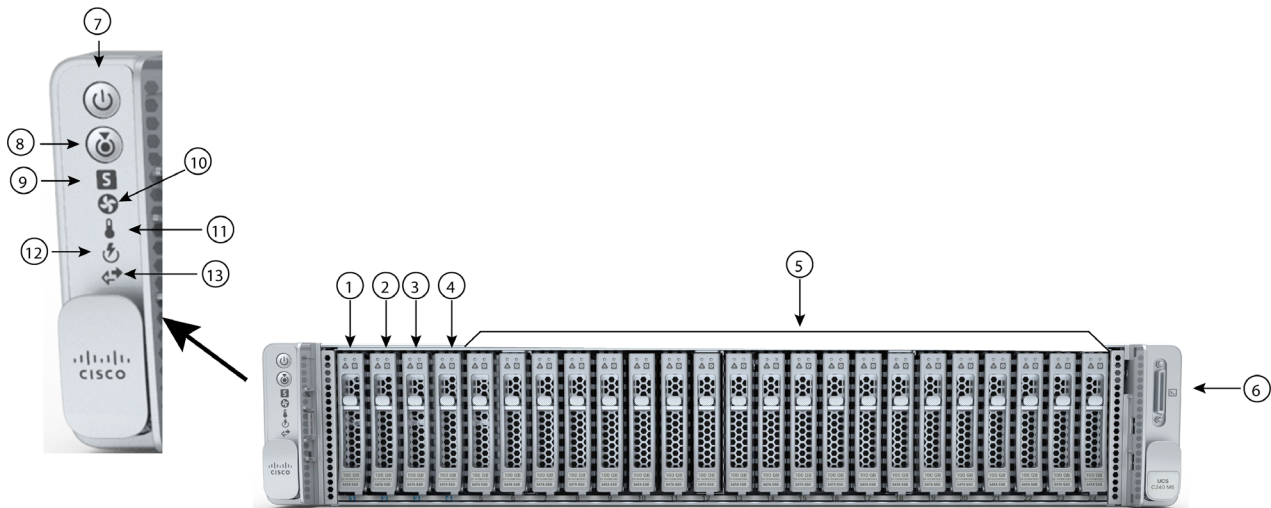

1 - 4	Drive bays 1 - 4 support SAS/SATA hard drives and solid state drives (SSDs) as well as NVMe PCIe drives ^{1, 2} .	9	System status LED
5	Drive bays 5 - 24 support SAS/SATA hard drives and solid state drives (SSDs) only	10	Fan status LED
6	KVM connector (used with KVM cable that provides two USB 2.0, one VGA, and one serial connector)	11	Temperature status LED
7	Power button/Power status LED	12	Power supply status LED
8	Unit Identification button/LED	13	Network link activity LED

Notes:

1. If front NVMe drives are selected, you must also select 2 CPUs.
2. You can mix and match in drive bays 1 - 4. For example, slots 1 and 2 can hold NVMe drives and slots 3 and 4 can hold SAS/SATA HDDs or SSDs.

Chassis Rear View - HXAF245C-M6SX (All Flash)

Figure 3 shows the external features of the rear panel.

Figure 3 Chassis Rear View (HXAF245C-M6SX)

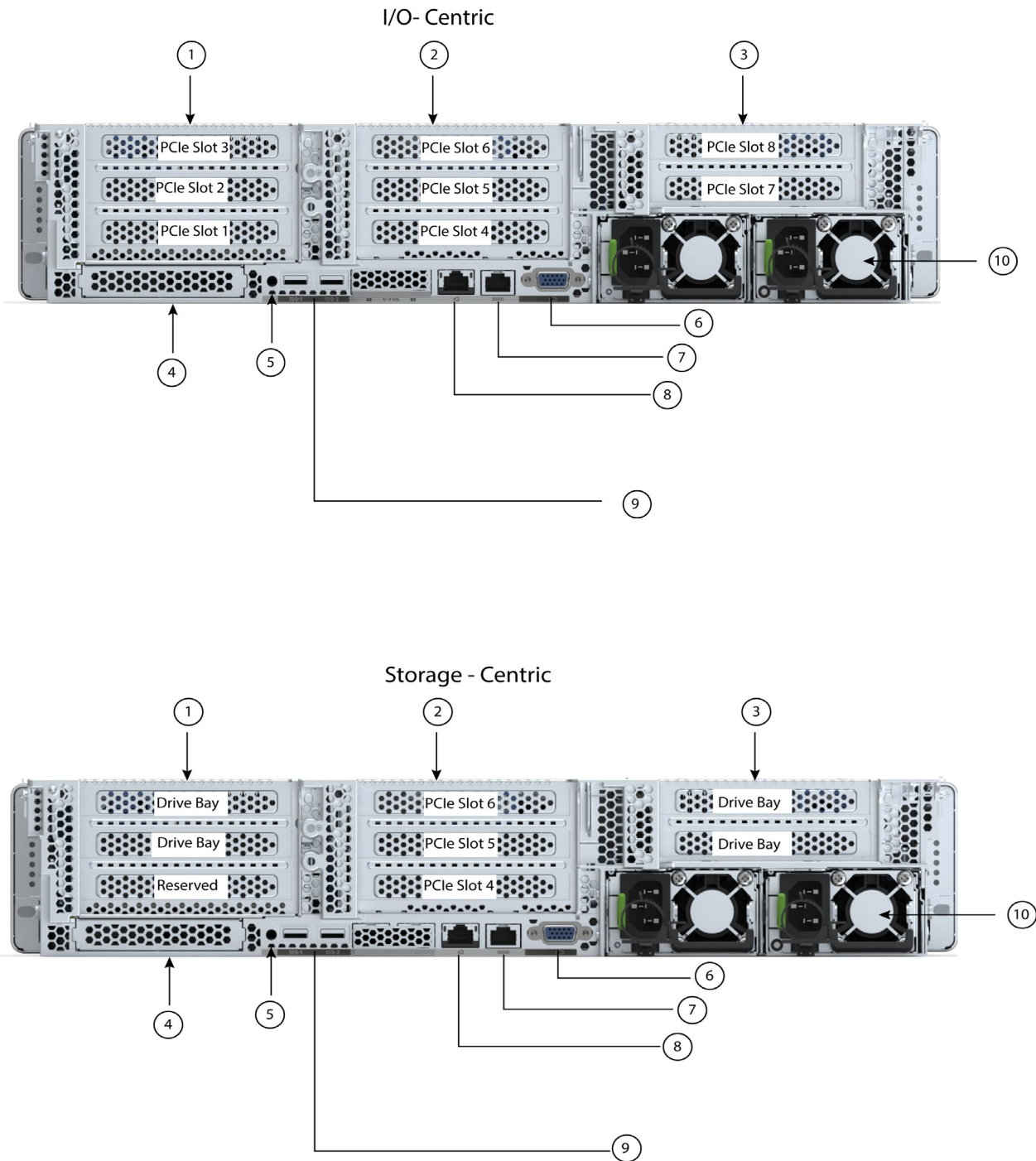

<p>1</p>	<p>There are two Riser 1 options: Riser 1A (I/O-centric, CPU1 control) Supports three PCIe slots:</p> <ul style="list-style-type: none"> ■ Slot 1 is full-height, 3/4 length, x8, NCSI ■ Slot 2 is full-height, full-length, x16, NCSI ■ Slot 3 is full-height, full-length, x8, no NCSI <p>Riser 1B (storage-centric, CPU1 control)</p> <ul style="list-style-type: none"> ■ Supports two SFF NVMe drives <ul style="list-style-type: none"> • Drive bay 102 (lower bay), x4 • Drive bay 101 (upper bay), x4 <p>See Riser Card Configurations and Options, page 76 for mechanical details.</p>	<p>6</p>	<p>VGA display port (DB15 connector)</p>
<p>2</p>	<p>Riser 2A (always I/O-centric, CPU2 control) Supports three PCIe slots:</p> <ul style="list-style-type: none"> ■ Slot 4 is full-height, 3/4 length, x8, NCSI ■ Slot 5 is full-height, full-length, x16, NCSI ■ Slot 6 is full-height, full length, x8, no NCSI 	<p>7</p>	<p>COM port (RJ45 connector)</p>
<p>3</p>	<p>There are three Riser 3 options Riser 3A (I/O-centric, CPU2 control)</p> <ul style="list-style-type: none"> ■ Supports two PCIe slots: <ul style="list-style-type: none"> • Slot 7 is full-height, full-length, x8, no NCSI • Slot 8 is full-height, full-length, x8, no NCSI <p>Riser 3B (storage-centric, CPU2 control)</p> <ul style="list-style-type: none"> ■ Supports two SFF NVMe drives <ul style="list-style-type: none"> • Drive bay 104 (lower bay), x4 • Drive bay 103 (upper bay), x4 <p>Riser 3C</p> <ul style="list-style-type: none"> ■ Supports one full-height, full-length, double-wide GPU (PCIe slot 7 only), x16 ■ Slot 8 is blocked by double-wide GPU <p>See Riser Card Configurations and Options, page 76 for details.</p>	<p>8</p>	<p>1 GbE dedicated Ethernet management port</p>
<p>4</p>	<p>Modular LAN-on-motherboard (mLOM)/OCP 3.0 card slot (x16)</p>	<p>9</p>	<p>USB 3.0 ports (two)</p>
<p>5</p>	<p>System ID pushbutton/LED</p>	<p>10</p>	<p>Power supplies (two)</p>



NOTE: For GPU support on a particular riser slot, see [Table 18 on page 43](#)

Chassis Front View - HX245C-M6SX (Hybrid)

Figure 2 shows the front View of the HX245C-M6SX (Hybrid) Server Node configured with 24 front drives and optionally 4 SAS/SATA rear drives.

Figure 4 Chassis Front View: HX245C-M6SX (Hybrid)

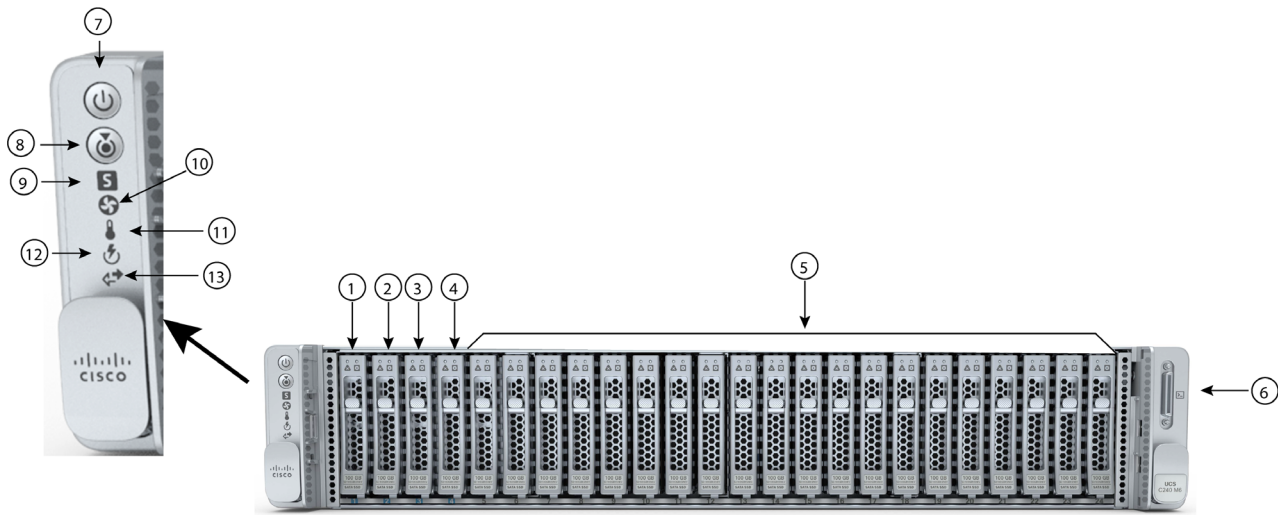

1 - 4	Drive bays 1 - 4 support SAS/SATA hard drives (HDDs) and solid state drives (SSDs)	9	System status LED
5	Drive bays 5 - 24 support SAS/SATA hard drives (HDDs) only	10	Fan status LED
6	KVM connector (used with KVM cable that provides two USB 2.0, one VGA, and one serial connector)	11	Temperature status LED
7	Power button/Power status LED	12	Power supply status LED
8	Unit Identification button/LED	13	Network link activity LED

Chassis Rear View - HX245C-M6SX (Hybrid)

Figure 3 shows the external features of the rear panel. The I/O centric version shows all PCIe slots. The storage centric version shows a combination of PCIe risers and storage bays.

Figure 5 Chassis Rear View: HX245C-M6SX (Hybrid)

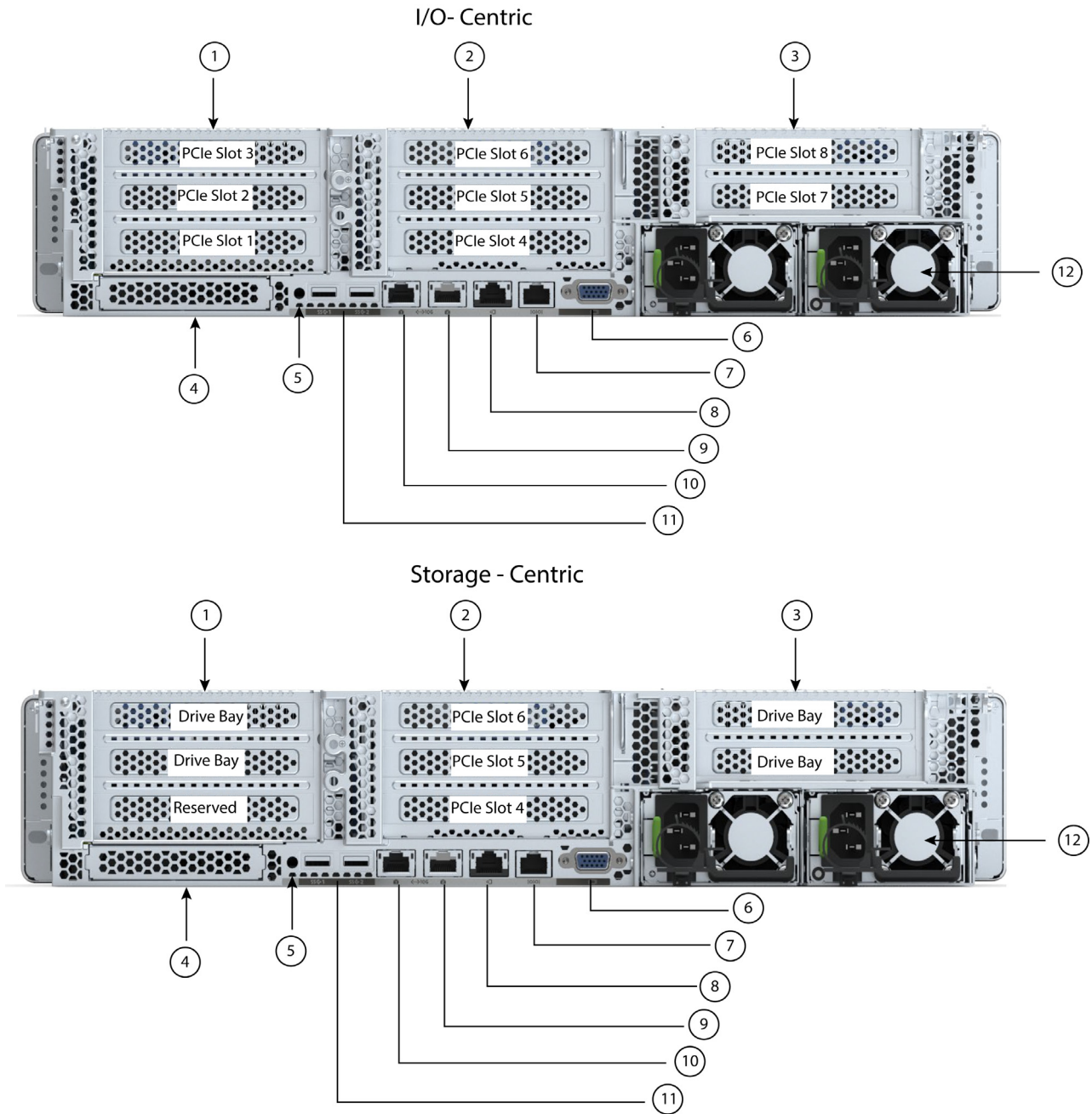

1	<p>There are two Riser 1 options:</p> <p>Riser 1A (I/O centric, CPU1 control)</p> <ul style="list-style-type: none"> ■ Supports three PCIe slots: <ul style="list-style-type: none"> • Slot 1 is full-height, 3/4 length, x8, NCSI • Slot 2 is full-height, full-length, x16, NCSI • Slot 3 is full-height, full-length, x8, no NCSI <p>Riser 1B (storage-centric, CPU1 control)</p> <ul style="list-style-type: none"> ■ Supports two SFF drives (SAS/SATA) <ul style="list-style-type: none"> • Slot 1 is reserved • Slot 2 (drive bay 102), x4 (CPU1 control) • Slot 3 (drive bay 101), x4 (CPU1 control) • When using a hardware drive controller card (SAS HBA) in the server, SAS/SATA HDDs or SSDs or PCIe drives are supported in the rear bays. <p>See Riser Card Configurations and Options, page 76 for details.</p>	7	COM port (RJ45 connector)
2	<p>Riser 2A (always I/O centric, CPU2 control)</p> <ul style="list-style-type: none"> ■ Supports three PCIe slots: <ul style="list-style-type: none"> • Slot 4 is full-height, 3/4 length, x8 • Slot 5 is full-height, full-length, x16 • Slot 6 is full-height, full length, x8 <p>See Riser Card Configurations and Options, page 76 for details.</p>	8	1 GbE dedicated Ethernet management port

<p>3</p>	<p>There are three Riser 3 options</p> <p>Riser 3A (I/O centric, CPU2 control)</p> <ul style="list-style-type: none"> ■ Supports two PCIe slots: <ul style="list-style-type: none"> • Slot 7 is full-height, full-length, x8, no NCSI • Slot 8 is full-height, full-length, x8, no NCSI <p>Riser 3B (storage-centric, CPU2 control)</p> <ul style="list-style-type: none"> ■ Supports two SFF drives (SAS/SATA) <ul style="list-style-type: none"> • Slot 7 (drive bay 104), x4 • Slot 8 (drive bay 103), x4 • When using a hardware drive controller card (SAS HBA) in the server, SAS/SATA HDDs or SSDs or PCIe drives are supported in the rear bays. <p>Riser 3C (for GPU, CPU2 control)</p> <ul style="list-style-type: none"> ■ Supports one full-height, full-length, double-wide GPU (PCIe slot 7 only), x16 ■ Slot 8 is blocked by double-wide GPU <p>See Riser Card Configurations and Options, page 76 for details.</p>	<p>9 -10</p>	<p>Dual 1/10 GbE Ethernet ports (LAN1, LAN2)</p> <p>LAN1 is left connector, LAN2 is right connector</p>
<p>4</p>	<p>Modular LAN-on-motherboard (mLOM) card slot (x16)</p>	<p>11</p>	<p>USB 3.0 ports (two)</p>
<p>5</p>	<p>System ID pushbutton/LED</p>	<p>12</p>	<p>Power supplies (two)</p>
<p>6</p>	<p>VGA display port (DB15 connector)</p>	<p>-</p>	<p>-</p>

BASE SERVER STANDARD CAPABILITIES and FEATURES

Table 1 lists the capabilities and features of the base server. Details about how to configure the server for a particular feature or capability (for example, number of processors, disk drives, or amount of memory) are provided in *CONFIGURING the SERVER, page 18*.

Table 1 Capabilities and Features

Capability/Feature	Description
Chassis	Two rack unit (2RU) chassis
CPU	One or two AMD® Rome®, Milan®, and Milan-X® family CPUs
Memory	32 slots for registered DIMMs (RDIMMs) or load-reduced DIMMs (LRDIMMs)
Multi-bit Error Protection	This server supports multi-bit error protection.
Video	<p>The Cisco Integrated Management Controller (CIMC) provides video using the Matrox G200e video/graphics controller:</p> <ul style="list-style-type: none"> ■ Integrated 2D graphics core with hardware acceleration ■ Embedded DDR memory interface supports up to 512 MB of addressable memory (8 MB is allocated by default to video memory) ■ Supports display resolutions up to 1920 x 1200 16bpp @ 60Hz ■ High-speed integrated 24-bit RAMDAC ■ Single lane PCI-Express host interface running at Gen 1 speed
Power subsystem	<p>Up to two of the following hot-swappable power supplies:</p> <ul style="list-style-type: none"> ■ 1050 W (AC) ■ 1050 W (DC) ■ 1600 W (AC) ■ 2300 W (AC) <p>One power supply is mandatory; one more can be added for 1 + 1 redundancy.</p>
Front Panel	A front panel controller provides status indications and control buttons.
ACPI	<p>This server supports the advanced configuration and power interface (ACPI)</p> <p>Rome - ACPI version 6.2 Milan - ACPI version 6.3</p>
Fans	Six hot-swappable fans for front-to-rear cooling
Infiniband	The InfiniBand architecture is supported by the PCIe slots.
Expansion slots	<ul style="list-style-type: none"> ■ Riser 1A (3 PCIe slots) ■ Riser 1B (2 drive bays) ■ Riser 2A (3 PCIe slots) ■ Riser 3A (2 PCIe slots) ■ Riser 3B (2 drive bays) ■ Riser 3C (1 PCIe slot) ■ Dedicated slots for a Cisco 12G SAS HBA. <p>For more details on the variations of riser 1, riser 2, and riser 3, see <i>Riser Card Configurations and Options, page 76</i>.</p>

Capability/ Feature	Description
Interfaces	<ul style="list-style-type: none"> ■ Rear panel <ul style="list-style-type: none"> • One 1Gbase-T RJ-45 management port • One RS-232 serial port (RJ45 connector) • One DB15 VGA connector • Two USB 3.0 port connectors • One flexible modular LAN on motherboard (mLOM)/OCP 3.0 slot that can accommodate various interface cards ■ Front panel <ul style="list-style-type: none"> • One KVM console connector (supplies two USB 2.0 connectors, one VGA DB15 video connector, and one serial port (RS232) RJ45 connector)
Internal storage devices	<p><u>Drive storage:</u></p> <p>The server is orderable in two different server node:</p> <p>HXAF245C-M6SX (All Flash):</p> <ul style="list-style-type: none"> ■ Up to 24 front SFF SAS/SATA/NVMe solid state drives (SSDs). 24 Drives are used as below: <ul style="list-style-type: none"> • Six to twenty-two SAS/SATA SSD (for capacity) • One NVMe SSD or one SAS/SATA SSD (for caching) • One SAS/SATA SSD (system drive for HXDP operations) ■ Up to 4 SFF rear-facing SAS/SATA/NVMe drives (Optional) <p>HX245C-M6SX (Hybrid):</p> <ul style="list-style-type: none"> ■ Up to 24 front SFF hard drives (HDDs) and solid state drives (SSDs). 24 Drives are used as below: <ul style="list-style-type: none"> • Six to twenty-two SAS HDD (for capacity) • One SAS/SATA SSD (for caching) • One SAS/SATA SSD (system drive for HXDP operations) ■ Up to 4 SFF rear-facing SAS/SATA drives (Optional) <p><u>Other storage:</u></p> <ul style="list-style-type: none"> ■ A mini-storage module connector on the motherboard supports a boot-optimized RAID controller carrier that holds two SATA M.2 SSDs. Mixing different capacity SATA M.2 SSDs is not supported.
Integrated management processor	<p>Baseboard Management Controller (BMC) running Cisco Integrated Management Controller (CIMC) firmware.</p> <p>Depending on your CIMC settings, the CIMC can be accessed through the 1GE dedicated management port or a Cisco virtual interface card (VIC).</p> <p>CIMC manages certain components within the server, such as the Cisco 12G SAS HBA.</p>
Storage controllers	<ul style="list-style-type: none"> ■ Cisco M6 12G SAS HBA: <ul style="list-style-type: none"> • No RAID support • JBOD/Pass-through Mode support • Each HBA supports up to 16 SAS/SATA internal drives

Capability/ Feature	Description
Modular LAN on Motherboard (mLOM)/ OCP ¹ 3.0 slot	The dedicated mLOM slot on the motherboard can flexibly accommodate the following cards: <ul style="list-style-type: none"> ■ Cisco Virtual Interface Cards
Intersight	Intersight provides server management capabilities
CIMC	Cisco Integrated Management Controller 4.2(1) or later

Notes:

1. Open Compute Project

CONFIGURING the SERVER

Follow these steps to configure the HyperFlex HX245C M6SX All Flash and Hybrid Server Nodes:

- *STEP 1 VERIFY SERVER SKU, page 19*
- *STEP 2 SELECT DEPLOYMENT MODE (OPTIONAL), page 20*
- *STEP 3 SELECT RISER CARDS (REQUIRED), page 21*
- *STEP 4 SELECT CPU(s), page 22*
- *STEP 5 SELECT MEMORY, page 25*
- *STEP 6 SELECT DRIVE CONTROLLERS, page 30*
- *STEP 7 SELECT DRIVES, page 31*
- *STEP 8 SELECT HYPERFLEX CONNECTIVITY MODE, page 36*
- *STEP 10 ORDER OPTIONAL PCIe OPTION CARD ACCESSORIES, page 40*
- *STEP 11 ORDER GPU CARDS (OPTIONAL), page 43*
- *STEP 12 ORDER POWER SUPPLY, page 45*
- *STEP 13 SELECT INPUT POWER CORD(s), page 46*
- *STEP 14 ORDER TOOL-LESS RAIL KIT AND OPTIONAL REVERSIBLE CABLE MANAGEMENT ARM, page 50*
- *STEP 15 ORDER SECURITY DEVICES (OPTIONAL), page 51*
- *STEP 16 ORDER TOOL-LESS RAIL KIT AND OPTIONAL REVERSIBLE CABLE MANAGEMENT ARM, page 52*
- *STEP 17 ORDER SECURITY DEVICES (OPTIONAL), page 53*
- *STEP 18 SELECT LOCKING SECURITY BEZEL (OPTIONAL), page 54*
- *STEP 19 SELECT HOST OPERATING SYSTEM, page 55*
- *STEP 20 SELECT HYPERFLEX DATA PLATFORM (HXDP) SOFTWARE, page 56*
- *STEP 21 CISCO INTERSIGHT, page 57*

STEP 1 VERIFY SERVER SKU

Table 2 PID of Major Line Bundle (MLB)

Product ID (PID)	Description
HX-M6-MLB	HX/HXAF M6 MLB This major line bundle (MLB) consists of the HyperFlex All Flash and Hybrid Server Nodes, with Intersight and HXDP software spare PIDs.

Select one of the server product ID (PID) from [Table 3](#).

Table 3 PID of the HyperFlex HX245C M6SX All Flash and Hybrid Base Server Nodes

Product ID (PID)	Description
HXAF245C-M6SX ¹	Cisco HyperFlex HXAF245 All Flash server node has Small form-factor (SFF) drives, with 24-drive backplane. <ul style="list-style-type: none"> ■ Front-loading drive bays 1–24 support 2.5-inch SAS/SATA/NVMe drives. ■ Optionally up to 4 rear facing SAS/SATA/NVMe drives ■ No CPU, memory, SSDs, PCIe cards, or power supply included
HX245C-M6SX	Cisco HyperFlex HX245 Hybrid server node has Small form-factor (SFF) drives, with 24-drive backplane. <ul style="list-style-type: none"> ■ Front-loading drive bays 1–24 support 2.5-inch SAS/SATA drives. ■ Optionally, 4 rear facing SAS/SATA drives ■ No CPU, memory, HDDs, PCIe cards, or power supply included

Notes:

1. This product may not be purchased outside of the approved bundles (must be ordered under the MLB)

The Cisco HyperFlex HX245C M6SX All Flash and Hybrid Server Nodes:

- Includes a 24-drive backplane
- Does not include power supply, CPU, memory DIMMs, hard disk drives (HDDs), solid-state drives (SSDs), NVMe drives, SD cards, riser 1, riser 2, riser 3, tool-less rail kit, or option cards.



NOTE: Use the steps on the following pages to configure the server with the components that you want to include.

STEP 2 SELECT DEPLOYMENT MODE (OPTIONAL)

Starting with HyperFlex 5.0(2a), the following 2 deployment options are supported

Select deployment mode

The available deployment modes are listed in [Table 4](#)

Table 4 Deployment Modes

Product ID (PID)	Description
HX-DC-FI	Deployment mode Selection PID to use Hyperflex with FI
HX-DC-NO-FI	Deployment mode Selection PID to use Hyperflex without FI

- **HX Data Center with Fabric Interconnect** - This deployment option connects the server to Cisco Fabric Interconnect. The installation for this type of deployment can be done using the standalone installer or from the Intersight. This deployment mode has been supported since launch of HyperFlex.
- **HX Data Center without Fabric Interconnect** - This deployment option allows server nodes to be directly connected to existing switches. The installation for this type of deployment can be done from the Intersight only.

Note the following apply:

- No support for SED drives
- No hyper-V support
- No support for PMem
- No support for Additional PCIe Cisco VIC
- No support for stretch cluster
- No support for Application acceleration engine

Selecting this option will hence grey out the unsupported options during ordering



NOTE:

- If no selection is done, the deployment mode is assumed to be DC with FI

STEP 3 SELECT RISER CARDS (REQUIRED)

Select risers from [Table 5](#).

Table 5 PIDs of the Risers

Product ID (PID)	Description
HX-RIS1A-240M6 (default riser)	C245 M6 Riser1A (controlled with CPU1) <ul style="list-style-type: none"> ■ PCIe slot 1 (bottom slot): full height, 3/4 length, x8, NCSI ■ PCIe slot 2 (middle slot): full height, full length (GPU Card), x16, NCSI ■ PCIe slot 3 (top slot): full height, full length, x8
HX-RIS1B-240M6 (storage riser)	C245 M6 Riser1B (controlled with CPU1) <ul style="list-style-type: none"> ■ Slot 1 (bottom slot) is reserved ■ Middle slot, 2.5" NVMe drive bay 102, x4 (controlled with CPU2) ■ Top slot, 2.5" NVMe drive bay 101, x4 (controlled with CPU2)
UCSC-RIS2A-240M6 (default riser)	C245 M6 Riser2A (controlled with CPU2) <ul style="list-style-type: none"> ■ PCIe slot 4 (bottom slot): full height, 3/4 length, x8, NCSI ■ PCIe slot 5 (middle slot): full height, full length (GPU Card), x16, NCSI ■ PCIe slot 6 (top slot): full height, full length, x8
HX-RIS3A-240M6 (default riser)	C245 M6 Riser3A (controlled with CPU2) <ul style="list-style-type: none"> ■ PCIe slot 7 (bottom slot): full height, full length, x8 ■ PCIe slot 8 (top slot): full height, full length, x8
HX-RIS3B-240M6 (storage riser)	C245 M6 Riser 3B (controlled with CPU2) <ul style="list-style-type: none"> ■ Bottom slot, 2.5" NVMe drive bay 104, x4 ■ Top slot, 2.5" NVMe drive bay 103, x4
HX-RIS3C-240M6 (GPU riser)	C240 M6 Riser 3C (controlled with CPU2) <ul style="list-style-type: none"> ■ Slot 7 supports one full-height, full-length, double-wide GPU (PCIe slot 7 only), x16 ■ Slot 8 blocked by double-wide GPU
UCSC-FBRS2-C240M6	Riser 2 Filler Blank
UCSC-FBRS3-C240M6	Riser 3 Filler Blank



NOTE: If there is any PCIe slot that does not have a card installed, you must order a blanking panel for that slot.

For additional details, see [Riser Card Configurations and Options, page 76](#).

STEP 4 SELECT CPU(s)

The standard CPU features are:

- AMD® Rome®, Milan®, and Milan-X® family CPUs
- CPU-to-CPU communication using Infinity Fabric Interconnect
- Cache size of up to 768 MB
- Up to 64 cores

Select CPUs

The available CPUs are listed in [Table 6](#)

Table 6 Available CPUs

Product ID (PID) ¹	Clock Freq (GHz)	Power (W)	L3 Cache Size (MB)	Cores	Highest DDR4 DIMM Clock Support (MHz) ²
Milan Processors					
HX-CPU-A7763	2.45	280	256	64	3200
HX-CPU-A7713	2.00	225	256	64	3200
HX-CPU-A7713P	2.00	225	256	64	3200
HX-CPU-A7663	2.00	225	256	56	3200
HX-CPU-A7643	2.30	225	256	48	3200
HX-CPU-A7543	2.80	225	256	32	3200
HX-CPU-A7543P	2.80	225	256	32	3200
HX-CPU-A7513	2.60	200	128	32	3200
HX-CPU-A75F3	2.95	280	256	32	3200
HX-CPU-A7413	2.65	180	128	24	3200
HX-CPU-A7453	2.75	180	64	28	3200
HX-CPU-A7443	2.85	200	128	24	3200
HX-CPU-A7443P	2.85	200	128	24	3200
HX-CPU-A74F3	3.20	240	256	24	3200
HX-CPU-A7343	3.20	190	128	16	3200
HX-CPU-A7313	3.00	155	128	16	3200
HX-CPU-A7313P	3.00	155	128	16	3200
HX-CPU-A73F3	3.50	240	256	16	3200
HX-CPU-A72F3	3.70	180	256	8	3200
Milan-X Processors					
HX-CPU-A7773X	2.20	280	768	64	3200
HX-CPU-A7573X	2.80	280	768	32	3200
HX-CPU-A7473X	2.80	240	768	24	3200
HX-CPU-A7373X	3.05	240	768	16	3200

Table 6 Available CPUs

Product ID (PID) ¹	Clock Freq (GHz)	Power (W)	L3 Cache Size (MB)	Cores	Highest DDR4 DIMM Clock Support (MHz) ²
Rome Processors					
HX-CPU-A7662	2.00	225	256	64	3200
HX-CPU-A7532	2.40	200	256	32	3200
HX-CPU-A7502P	2.50	180	128	32	3200
HX-CPU-A7352	2.30	155	128	24	3200
HX-CPU-A7302	3.00	155	128	16	3200
HX-CPU-A7282	2.80	120	64	16	3200
HX-CPU-A7272	2.90	120	64	12	3200
HX-CPU-A7262	3.20	155	128	8	3200
HX-CPU-A7252	3.10	120	64	8	3200
HX-CPU-A7232P	3.10	120	32	8	3200

Notes:

1. Any CPU PID ending in “P” cannot be used in a 2-CPU system. They can only be used in a 1-CPU system.
2. If higher or lower speed DIMMs are selected than what is shown in [Table 7 on page 25](#) for a given CPU speed, the DIMMs will be clocked at the lowest common denominator of CPU clock and DIMM clock.



CAUTION: For systems configured with processors operating above 28° C [82.4° F], a fan fault or executing workloads with extensive use of heavy instructions sets may assert thermal and/or performance faults with an associated event recorded in the System Event Log (SEL).

If an NVIDIA A10, or A100 GPU is installed, or rear HDDs are installed, the 28° C [82.4° F] restriction changes to 25° C [77° F]

Approved Configurations

(1) One-CPU Configuration:

- Choose one CPU from any one of the rows of [Table 6 Available CPUs, page 22](#)

(2) Two-CPU Configuration:

- Choose two identical CPUs from any one of the rows of [Table 6 Available CPUs, page 22](#)

**NOTE:**

- You cannot have two CPUs ending in a “P” suffix in a two-CPU configuration.
- If you configure a server with one CPU with a “P” suffix, you cannot later upgrade to a 2-CPU system with two of these CPUs.

Caveats

- The selection of 1 or 2 CPUs depends on the desired server functionality. See the following sections:
 - [STEP 5 SELECT MEMORY, page 25](#)
 - [STEP 6 SELECT DRIVE CONTROLLERS, page 30](#)
 - [STEP 7 SELECT DRIVES, page 31](#)
 - [STEP 8 SELECT HYPERFLEX CONNECTIVITY MODE, page 36](#)

STEP 5 SELECT MEMORY

The available memory main characteristics for the Cisco HyperFlex HX245C M6SX All Flash and Hybrid Server Nodes are as follows:

- Clock speed: 3200 MHz
- Ranks per DIMM: 1, 2, 4, or 8
- Operational voltage: 1.2 V
- Registered ECC DDR4 DIMMS (RDIMMs) or Load-reduced DIMMs (LRDIMMs).

Memory is organized with eight memory channels per CPU, with one or two DIMMs per channel (DPC).

Select DIMMs

The supported memory DIMMs are listed in [Table 7](#).

Table 7 Available DDR4 DIMMs

Product ID (PID)	PID Description	Voltage	Ranks /DIMM
3200-MHz DIMMs			
HX-MR-X16G1RW	16 GB RDIMM SRx4 3200 (8Gb)	1.2 V	1
HX-MR-X32G1RW	32 GB RDIMM SRx4 3200 (16Gb)	1.2 V	1
HX-MR-X32G2RW	32 GB RDIMM DRx4 3200 (8Gb)	1.2 V	2
HX-MR-X64G2RW	64 GB RDIMM DRx4 3200 (16Gb)	1.2 V	2
HX-ML-128G4RW	128 GB LRDIMM QRx4 3200 (16Gb) (non-3DS)	1.2 V	4
HX-ML-256G8RW ¹	256 GB LRDIMM 8Rx4 3200 (16Gb) (3DS)	1.2 V	8
DIMM Blank²			
UCS-DIMM-BLK	UCS DIMM Blank		

Notes:

1. 256 GB DIMMs cannot be combined with GPU cards, and the ambient temperature shall be limited to a maximum of 28°C.
2. Any empty DIMM slot must be populated with a DIMM blank to maintain proper cooling airflow.

Figure 6 is the supported 8-channel configuration, with one or two DPC.

Figure 6 8-Channel Memory Organization

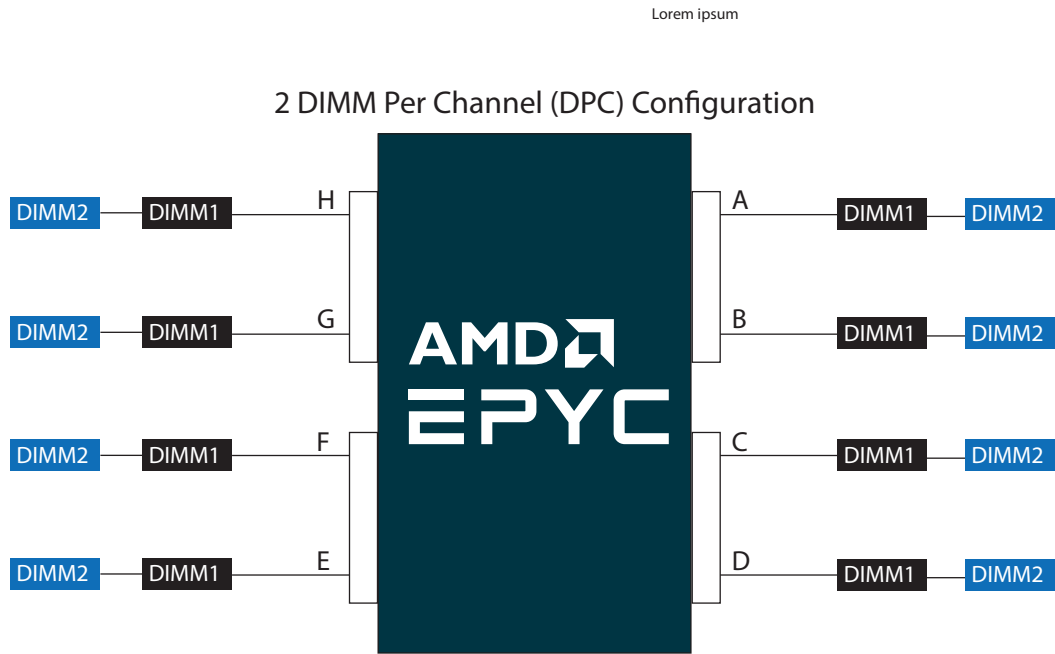

Note: Blue DIMM sockets are farthest from CPU and black DIMM sockets are closest to CPU

Approved Configurations

(1) One CPU (CPU1) population

- Select 4, 6, 8, 10, 12, 14, or 16 DIMMs for the 1 CPU system.
- 4 DIMMs configuration is only allowed, if eight channels cannot be populated, and only with processors that have 128MB L3 cache or less.

The DIMMs will be placed by the factory as shown in the following table.

Total DIMM number per system	CPU 1 DIMM Placement in Channels (for identically ranked DIMMs)
4	(C2, D2); (G2, H2)
6	(C2, D2); (G2, H2); (A2, E2)
8	(C2, D2); (G2, H2); (A2, E2); (B2, F2)
10	(C2, D2); (G2, H2); (A2, E2); (B2, F2); (D1, E1)
12	(C2, D2); (G2, H2); (A2, E2); (B2, F2); (D1, E1); (B1, G1)
14	(C2, D2); (G2, H2); (A2, E2); (B2, F2); (D1, E1); (B1, G1); (C1, F1)
16	(C2, D2); (G2, H2); (A2, E2); (B2, F2); (D1, E1); (B1, G1); (C1, F1); (A1, H1)

(2) Two CPU (CPU1 and CPU2) population

- Select 8,12,16,20,24,28,32 DIMMs for the 2 CPUs system.
- 8 DIMMs for 2 CPUs system configuration is only allowed if the 16 channels cannot be populated, and only with processors that have 128MB L3 cache or less.

The DIMMs will be placed by the factory as shown in the following tables.

Total DIMM number per system	CPU 1 DIMM Placement in Channels (for identically ranked DIMMs)	CPU 2 DIMM Placement in Channels (for identically ranked DIMMs)
8	(C2, D2); (G2, H2)	(C2, D2); (G2, H2)
12	(C2, D2); (G2, H2); (A2, E2)	(C2, D2); (G2, H2); (A2, E2)
16	(C2, D2); (G2, H2); (A2, E2); (B2, F2)	(C2, D2); (G2, H2); (A2, E2); (B2, F2)
20	(C2, D2); (G2, H2); (A2, E2); (B2, F2); (D1, E1)	(C2, D2); (G2, H2); (A2, E2); (B2, F2); (D1, E1)
24	(C2, D2); (G2, H2); (A2, E2); (B2, F2); (D1, E1); (B1, G1)	(C2, D2); (G2, H2); (A2, E2); (B2, F2); (D1, E1); (B1, G1)
28	(C2, D2); (G2, H2); (A2, E2); (B2, F2); (D1, E1); (B1, G1); (C1, F1)	(C2, D2); (G2, H2); (A2, E2); (B2, F2); (D1, E1); (B1, G1); (C1, F1)
32	(C2, D2); (G2, H2); (A2, E2); (B2, F2); (D1, E1); (B1, G1); (C1, F1); (A1, H1)	(C2, D2); (G2, H2); (A2, E2); (B2, F2); (D1, E1); (B1, G1); (C1, F1); (A1, H1)



NOTE: System performance is optimized when the DIMM type and quantity are equal for both CPUs, and when all channels are filled equally across the CPUs in the server.

Table 8 on page 28 and *Table 9 on page 28* give the maximum DRAM speeds for various DIMM populations.

Table 8 Memory Speed for 1 DIMM Per Channel (1 DPC)

DIMM Type	DIMM Population	Maximum DRAM Frequency (MHz)
	DIMM0	
RDIMM	One rank	3200
	Two ranks	3200
LRDIMM	Four ranks	3200
	Eight ranks	3200

Table 9 Memory Speed for 2 DIMMs Per Channel (2DPC)

DIMM Type	DIMM Population		Maximum DRAM Frequency (MHz)
	DIMM0	DIMM1	
RDIMM	One rank	One rank	2933
	One rank	Two rank	2933
	Two rank	Two rank	2933
LRDIMM	Four ranks	Four ranks	2933
	Eight ranks	Eight ranks	2933

DIMM Rules

- DIMM Mixing:
 - Mixing different types of DIMM (RDIMM with any type of LRDIMM or 3DS LRDIMM with non-3DS LRDIMM) is not supported within a server.
 - Mixing RDIMM with RDIMM types is allowed if they are mixed in same quantities, in a balanced configuration.
 - Mixing 16 GB, 32 GB, and 64 GB RDIMMs is supported.
 - 128 GB and 256 GB LRDIMMs cannot be mixed with other RDIMMs
 - 128 GB non-3DS LRDIMMs cannot be mixed with 256 GB 3DS LRDIMMs

- General Population Order Guidelines
 - For best performance, populate all eight memory channels for each CPU socket, with every channel having the same capacity.
 - Populate open channels before populating two DIMMs on a given channel.
 - In 2 DPC configurations where only one DIMM is populated on a channel, populate the DIMM socket physically farthest away from the processor.
 - Balance memory capacity per channel pair on a given CPU.
 - Balance memory capacity per CPU socket in a two-socket system.
 - DIMMs within the same channel must be of the same base DIMM module type (all RDIMM, LRDIMM, or 3DS).
 - DIMMs within the same channel must be of the same DRAM density.
 - All memory channels operate at the same frequency. The system will use the highest common supported frequency when populated with different speed DIMMs. The highest common supported speed is the rated speed of the slowest DIMM in the system while also applying the population speed limits for the configuration (1 of 1, 1 of 2, 2 of 2).

STEP 6 SELECT DRIVE CONTROLLERS

The following list summarizes how drives are controlled on the server:

- SAS/SATA drives are controlled through one or two Cisco 12G SAS HBAs
- NVMe PCIe drives are controlled directly from the CPUs

Cisco 12G SAS HBA

This HBA supports up to 16 SAS or SATA drives operating at 3 Gbs, 6 Gbs, and 12Gbs. It supports JBOD or pass-through mode (not RAID) and plugs directly into a dedicated slot. Two of these HBAs are required to control 24 drives.

Select RAID Controller Options

Select the following:

- One Cisco 12G SAS HBA (see [Table 10](#))

Table 10 Hardware Controller Options

Product ID (PID)	PID Description
Controllers for Internal Drives	
Note that if a Cisco 12G SAS HBA is selected, it is factory-installed in the drive backplane connector.	
HX-SAS-240M6 ¹	Cisco 12G SAS HBA <ul style="list-style-type: none"> ■ Supports up to 16 internal SAS HDDs and SAS/SATA SSDs ■ Supports JBOD or pass-through mode

Notes:

1. Two of these controllers are required to control 24 front drives and four rear drives.

Approved Configurations

- HXAF245C-M6SX (24-drive SAS/SATA backplane and optionally 4 of those can be NVMe)
- HX245C-M6SX (24-drive SAS/SATA backplane)
- There is no RAID support for NVMe drives.
- Each Cisco 12G SAS HBA supports up to 16 internal SAS/SATA SSDs or HDDs with JBOD support. To support 24 front drives, you must select two controllers.

STEP 7 SELECT DRIVES

The standard disk drive features are:

- 2.5-inch small form factor
- Hot-pluggable
- Drives come mounted in sleds

Select Drives - HXAF245C-M6SX (All Flash)

The available drives are listed in [Table 11](#).



Data Center Deployment Mode

NOTE: Data center deployment mode without fabric interconnect (HX-DC-no-FI) does not support SED drives. Refers to [STEP 2](#) for the details.

Table 11 Available Hot-Pluggable Sled-Mounted Drives

Product ID (PID)	PID Description	Drive Type	Capacity
Front Capacity Drive			
HX-SD960G6S1X-EV	960GB 2.5 inch Enterprise Value 6G SATA SSD	SATA	960 GB
HX-SD19T6S1X-EV	1.9TB 2.5 inch Enterprise Value 6G SATA SSD	SATA	1.9 TB
HX-SD38T6S1X-EV	3.8TB 2.5 inch Enterprise Value 6G SATA SSD	SATA	3.8 TB
HX-SD76T6S1X-EV	7.6TB 2.5 inch Enterprise Value 6G SATA SSD	SATA	7.6 TB
Rear Capacity Drive			
HX-SD960G6S1X-EV	960GB 2.5 inch Enterprise Value 6G SATA SSD	SATA	960 GB
HX-SD19T6S1X-EV	1.9TB 2.5 inch Enterprise Value 6G SATA SSD	SATA	1.9 TB
HX-SD38T6S1X-EV	3.8TB 2.5 inch Enterprise Value 6G SATA SSD	SATA	3.8 TB
HX-SD76T6S1X-EV	7.6TB 2.5 inch Enterprise Value 6G SATA SSD	SATA	7.6 TB
Front Cache Drive			
HX-NVMEXPB-I375	375GB 2.5in Intel Optane NVMe Extreme Performance SSD	NVMe	375 GB
HX-SD800GK3X-EP	800GB 2.5in Enterprise Performance 12G SAS SSD(3X endurance)	SAS	800 GB
Front System Drive			
HX-SD240GM1X-EV	240GB 2.5 inch Enterprise Value 6G SATA SSD	SATA	240 GB
Boot Drive			
HX-M2-240GB	240GB SATA M.2	SATA	240 GB
HX-M2-HWRAID	Cisco Boot optimized M.2 Raid controller		

Table 11 Available Hot-Pluggable Sled-Mounted Drives (*continued*)

Product ID (PID)	PID Description	Drive Type	Capacity
<p>NOTE: Cisco uses solid state drives (SSDs) from a number of vendors. All solid state drives (SSDs) are subject to physical write limits and have varying maximum usage limitation specifications set by the manufacturer. Cisco will not replace any solid state drives (SSDs) that have exceeded any maximum usage specifications set by Cisco or the manufacturer, as determined solely by Cisco.</p>			

Approved Configurations

- Capacity drive:
 - **I/O Centric:** Six to twenty-two front capacity drives
 - **Storage Centric:** Six to twenty-six (twenty-two front + four rear) capacity drive



NOTE:

- Rear drives can only be selected once after the front drive slots are filled.
- For cluster scale related information please see the product [release notes](#).

- One cache drive



NOTE:

- When configuring front facing drives with NVMe drives, you must order an NVMe cable (PID = CBL-FNVMe-240M6) along with the drives.

- One system drive

- One boot drive

**NOTE:**

- Order two identical M.2 SATA SSDs for the boot-optimized RAID controller. You cannot mix M.2 SATA SSD capacities.
 - It is recommended that M.2 SATA SSDs be used as boot-only devices.
 - The Boot-Optimized RAID controller supports VMWare, Windows and Linux Operating Systems.
 - CIMC/UCSM is supported for configuring of volumes and monitoring of the controller and installed SATA M.2 drives.
 - The minimum version of Cisco IMC and Cisco UCS Manager that supports this controller is 4.2(1) and later. The name of the controller in the software is MSTOR-RAID
 - The SATA M.2 drives can boot in UEFI mode only. Legacy boot mode is not supported.
 - Hot-plug replacement is not supported. The server must be powered off.
 - The boot-optimized RAID controller is supported when the server is used as a compute node in HyperFlex configurations.
 - See [Figure 11 on page 72](#) for the location of the module connector on the motherboard. This connector accepts the boot-optimized RAID controller.
-

Select Drives - HX245C-M6SX (Hybrid)

The available drives are listed in [Table 12](#).



Data Center Deployment Mode

NOTE: Data center deployment mode without fabric interconnect (HX-DC-no-FI) does not support SED drives. Refers to [STEP 2](#) for the details.

Table 12 Available Hot-Pluggable Sled-Mounted Drives

Product ID (PID)	PID Description	Drive Type	Capacity
Front Capacity Drive			
HX-HD12TB10K12N	1.2TB 12G SAS 10K RPM SFF HDD	SAS	1.2 TB
HX-HD18TB10K4KN	1.8TB 12G SAS 10K RPM SFF HDD (4K)	SAS	1.8 TB
HX-HD24TB10K4KN	2.4TB 12G SAS 10K RPM SFF HDD (4K)	SAS	2.4 TB
Rear Capacity Drive			
HX-HD12TB10K12N	1.2TB 12G SAS 10K RPM SFF HDD	SAS	1.2 TB
HX-HD18TB10K4KN	1.8TB 12G SAS 10K RPM SFF HDD (4K)	SAS	1.8 TB
HX-HD24TB10K4KN	2.4TB 12G SAS 10K RPM SFF HDD (4K)	SAS	2.4 TB
Front Cache Drive			
HX-SD16TK3X-EP	1.6TB 2.5in Enterprise Performance 12G SAS SSD(3X endurance)	SAS	1.6 TB
Front System Drive			
HX-SD240GM1X-EV	240GB 2.5 inch Enterprise Value 6G SATA SSD	SATA	240 GB
Boot Drives			
HX-M2-240GB	240GB SATA M.2	SATA	240 GB
HX-M2-HWRAID	Cisco Boot optimized M.2 Raid controller		
<p>NOTE: Cisco uses solid state drives (SSDs) from a number of vendors. All solid state drives (SSDs) are subject to physical write limits and have varying maximum usage limitation specifications set by the manufacturer. Cisco will not replace any solid state drives (SSDs) that have exceeded any maximum usage specifications set by Cisco or the manufacturer, as determined solely by Cisco.</p>			

Approved Configurations

- Capacity drive:
 - **I/O Centric:** Six to twenty-two front capacity drives
 - **Storage Centric:** Six to twenty-six (twenty two front + four rear) capacity drive.
-



NOTE:

- Rear drives can only be selected once after the front drive slots are filled.
 - For cluster scale related information please see the product [release notes](#).
-

- One cache drive
 - One system drive
 - One boot drive
-



NOTE:

- Order two identical M.2 SATA SSDs for the boot-optimized RAID controller. You cannot mix M.2 SATA SSD capacities.
 - It is recommended that M.2 SATA SSDs be used as boot-only devices.
 - The Boot-Optimized RAID controller supports VMWare, Windows and Linux Operating Systems.
 - CIMC/UCSM is supported for configuring of volumes and monitoring of the controller and installed SATA M.2 drives.
 - The minimum version of Cisco IMC and Cisco UCS Manager that supports this controller is 4.2(1) and later. The name of the controller in the software is MSTOR-RAID.
 - The SATA M.2 drives can boot in UEFI mode only. Legacy boot mode is not supported.
 - Hot-plug replacement is not supported. The server must be powered off.
 - The boot-optimized RAID controller is supported when the server is used as a compute node in HyperFlex configurations.
 - See [Figure 11 on page 72](#) for the location of the module connector on the motherboard. This connector accepts the boot-optimized RAID controller.
-



NOTE: When you order front-facing NVMe drives, an NVMe cable (PID CBL-SDFNVME-245M6) is included along with the drives.

If you decide to add front-facing NVMe drives later, you need to order the drives as spares and also an NVMe cable as a spare (PID CBL-SDFNVME-245M6=).

See [SPARE PARTS, page 84](#) for all spare drives and drive cables.

STEP 8 SELECT HYPERFLEX CONNECTIVITY MODE

Starting with HyperFlex 5.0(2a), the following two Connectivity options are supported

Select Connectivity mode

The available connectivity modes are listed in [Table 13](#)

Table 13 Connectivity Modes

Product ID (PID)	Description
HX-VIC-MODE	Hyperflex VIC Connectivity Mode
HX-NIC-MODE ¹	Hyperflex NIC Connectivity Mode

Notes:

1. Selection of Deployment Mode Option (HX-DC-NO-FI) is required for the NIC Connectivity Mode. Minimum 4 NIC Ports required, If NIC mode is selected and Double-Wide GPU is selected from R2 Slot5 x16, then must select quad port PID from R2 Slot 4 x8 PCIe NIC option and cannot make selection from R2 Slot 6 x8 PCIe NIC Option.

Table 14 Available Cards for the Connectivity Modes

Product ID (PID)	Description
HyperFlex VIC Connectivity Mode	
HX-M-V25-04	Cisco UCS VIC 1467 quad port 10/25G SFP28 mLOM
HX-M-V100-04	Cisco UCS VIC 1477 dual port 40/100G QSFP28 mLOM
HyperFlex NIC Connectivity Mode	
R2 Slot 4 x8 PCIe NIC	
HX-PCIE-ID10GF	Intel X710 dual-port 10G SFP+
HX-PCIE-IQ10GF	Intel X710 quad-port 10G SFP+ NIC
HX-P-I8D25GF	Cisco-Intel E810XXVDA2 2x25/10 GbE SFP28 PCIe NIC
HX-P-I8Q25GF	Cisco-Intel E810XXVDA4L 4x25/10 GbE SFP28 PCIe NIC
R2 Slot 6 x8 PCIe NIC	
HX-PCIE-ID10GF	Intel X710 dual-port 10G SFP+
HX-PCIE-IQ10GF	Intel X710 quad-port 10G SFP+ NIC
HX-P-I8D25GF	Cisco-Intel E810XXVDA2 2x25/10 GbE SFP28 PCIe NIC
HX-P-I8Q25GF	Cisco-Intel E810XXVDA4L 4x25/10 GbE SFP28 PCIe NIC

STEP 9 SELECT OPTION CARD(S)

For up-to-date server compatibility, please check the Hardware and Software compatibility list (HCL) at <https://ucshcltool.cloudapps.cisco.com/public/>.

The standard card offerings are:

- Modular LAN on Motherboard (mLOM)
- Virtual Interface Cards (VICs)
- Network Interface Cards (NICs)

Select Option Cards

The available option cards are listed in [Table 15](#).



Data Center Deployment Mode

NOTE:

- Data center deployment mode without fabric interconnect (HX-DC-no-FI) does not support HX-PCIE-C25Q-04. Refer to [STEP 2](#) for the details.
- HX-M-V100-04 require HXDP 5.0(2a) or higher for data center deployment mode without fabric interconnect (DC-no-FI).

Table 15 Available Option Cards

Product ID (PID)	PID Description	Location	Card Size ¹
Virtual Interface Card (VICs)			
HX-PCIE-C100-04	Cisco UCS VIC 1495 Dual Port 40/100G QSFP28 CNA PCIe	Riser 1, 2, or 3	HHHL, SS
HX-PCIE-C25Q-04	Cisco UCS VIC 1455 quad port 10/25G SFP28 PCIe	Riser 1, 2, or 3	HHHL, SS
Network Interface Cards (NICs)			
1 Gb NICs			
HX-PCIE-IRJ45	Intel i350 quad-port 1G copper PCIe	Riser 1, 2, or 3	HHHL, SS
10 Gb NICs			
HX-PCIE-ID10GF	Intel X710-DA2 Dual Port 10Gb SFP+ NIC	Riser 1, 2, or 3	HHHL, SS
HX-P-ID10GC	Cisco-Intel X710T2LG 2x10 GbE RJ45 PCIe NIC	Riser 1, 2, or 3	HHHL, SS
HX-PCIE-IQ10GF	Intel X710 quad-port 10G SFP+ NIC	Riser 1, 2, or 3	FHHL, SS
25 Gb NICs			
HX-P-I8D25GF	Cisco-Intel E810XXVDA2 2x25/10 GbE SFP28 PCIe NIC	Riser 1, 2, or 3	HHHL, SS
HX-P-I8Q25GF	Cisco-Intel E810XXVDA4L 4x25/10 GbE SFP28 PCIe NIC	Riser 1, 2, or 3	FHHL, SS

Notes:

1. HHHL = half-height, half-length; HHL = half-height, full-length; SS = single-slot; DS = double-slot

Approved Configuration

- For 1-CPU systems:
 - Only PCIe slots 1, 2, and 3 on PCIe riser 1A are available for a 1-CPU system.
 - The PCIe slots on riser 2 are not supported on 1-CPU systems. The riser 2 slots are full-height PCIe slots 4, 5, and 6 (see [Figure 3 on page 9](#)). These are the slots in the middle when looking at the rear of the server. Slot 4 is the bottom slot.
 - The PCIe slots on riser 3 are not supported on 1-CPU systems. The riser 3 slots are full-height PCIe slots 7 and 8 (see [Figure 3 on page 9](#)). These are the slots on the right when looking at the rear of the server. Slot 7 is the bottom slot.
 - Only a single plug-in PCIe VIC card may be installed on a 1-CPU system, and it must be installed in slots 1, 2, or 3 of riser 1A.
 - You can order an mLOM VIC card to be installed in the mLOM/OCP 3.0 slot internal to the chassis and thus have two VIC cards in operation at the same time. If you order a GPU, it must be installed in slots as specified in [Table 19 on page 43](#). See [Table 15 on page 37](#) for the selection of plug-in and mLOM VIC cards. See also [Table 1 on page 15](#) and [Serial Port Details, page 83](#) or the PCIe slot physical descriptions.
- For 2-CPU systems:
 - The following PCIe slots are available:
 - Three on PCIe riser 1A (PCIe slots 1, 2, and 3),
 - Three on PCIe riser 2A (PCIe slots 4, 5, and 6),
 - Two on PCIe riser 3A (PCIe slots 7 and 8).
 - Two plug-in PCIe VIC cards can be installed in dual CPU systems, using slots 2 and 5. In addition, you can order an mLOM VIC card, which is installed in the mLOM/OCP 3.0 slot inside the chassis and thus have three VIC cards in operation at the same time. See [Table 15 on page 37](#) for the selection of plug-in and mLOM VIC cards. See also [Table 1 on page 15](#) and [Serial Port Details, page 83](#) for the PCIe slot physical descriptions.
 - If GPUs are installed in slot 2 of riser 1A or slot 5 of riser 2A, the NCSI capability automatically switches over to slot 1 of riser 1A or slot 4 of Riser 2A. Therefore, Cisco PCIe VICs can be installed in slots 1 and 4 if GPUs are installed in slots 2 and 5. If you order multiple GPUs, they must be installed as shown in [Table 19 on page 43](#).
 - The server supports up to two PCIe Cisco VICs plus an mLOM VIC

However, single-wire management is supported on only one VIC at a time. If multiple VICs are installed on a server, only one slot has NCSI enabled at a time and for single wire management, priority goes to the mLOM/OCP 3.0 slot, then slot 2, then slot 5 for NCSI management traffic. When multiple cards are installed, connect the single wire management cables in the priority order mentioned above.
- To help ensure that your operating system is compatible with the card you have selected, or to see additional cards that have been qualified to work with the Cisco HyperFlex HX245C

M6SX All Flash and Hybrid Server Nodes, but are not sold on the Cisco price list, check the Hardware Compatibility List at this link

http://www.cisco.com/en/US/products/ps10477/prod_technical_reference_list.html

STEP 10 ORDER OPTIONAL PCIe OPTION CARD ACCESSORIES

- These optics and cables have been tested for compatibility and are approved for use with Ethernet Network Adapter (as of the time of this publication). For the latest update, check the and consult Cisco Compatibility Matrix at <https://tmgmatrix.cisco.com>.
- For list of supported optics and cables for VIC 1455, VIC 1467, VIC 1495 and VIC 1477 refer to VIC 1400 series data sheet at the following links:
 - <https://www.cisco.com/c/en/us/products/collateral/interfaces-modules/unified-computing-system-adapters/datasheet-c78-741130.html>
 - <https://www.cisco.com/c/en/us/products/collateral/interfaces-modules/unified-computing-system-adapters/datasheet-c78-734727.html>

Select

- NIC Interoperability with Cisco Cables/Optics (*Table 16 on page 40 through Table 17 on page 41*).
- NIC Interoperability with Intel Cables/Optics (*Table 18 on page 41*).

Table 16 10G NIC Interoperability with Cisco Cables/Optics

Cisco Product ID (PID)	HX- PCIE-ID10GF	HX- PCIE-IQ10GF	HX- P-ID10GC
Cisco Direct Attach Cables (DAC)			
SFP-H10GB-CU1M	✓	✓	
SFP-H10GB-CU3M	✓	✓	
SFP-H10GB-CU5M	✓	✓	
SFP-H10GB-ACU7M	✓	✓	
SFP-H10GB-ACU10M	✓	✓	
SFP-10G-AOC1M	✓	✓	
SFP-10G-AOC2M	✓	✓	
SFP-10G-AOC3M	✓	✓	
SFP-10G-AOC5M	✓	✓	
SFP-10G-AOC7M	✓	✓	
SFP-10G-AOC10M	✓	✓	
UTP/RJ45			✓
Cisco Optical Transceivers			
SFP-10G-SR	✓	✓	
SFP-10G-SR-S	✓	✓	
SFP-10G-LR	✓	✓	
SFP-10G-LR-S	✓	✓	
GLC-SX-MMD	✓	✓	

Table 17 25G NIC Interoperability with Cisco Cables/Optics

Cisco Product ID (PID)	HX-P-M5D25GF	HX-P-I8Q25GF	HX-P-I8D25GF
Cisco Direct Attach Cables (DAC)			
SFP-H10GB-CU1M	✓	✓	✓
SFP-H10GB-CU3M	✓	✓	✓
SFP-H10GB-CU4M	✓		
SFP-H10GB-CU5M	✓	✓	✓
SFP-H10GB-ACU7M	✓		
SFP-H10GB-ACU10M	✓		
SFP-10G-AOC7M		✓	✓
SFP-10G-AOC10M	✓		
SFP-25G-AOC10M	✓	✓	✓
SFP-25G-AOC5M	✓		
SFP-25G-AOC7M	✓		
QSFP-4SFP25G-CU2M		✓	✓
SFP-H25G-CU1M	✓	✓	✓
SFP-H25G-CU2M	✓	✓	✓
SFP-H25G-CU2.5M	✓		
SFP-H25G-CU3M	✓	✓	✓
SFP-H25G-CU4M	✓		
SFP-H25G-CU5M	✓	✓	✓
Cisco Optical Transceivers			
SFP-10G-SR	✓	✓	✓
SFP-10G-SR-S		✓	✓
SFP-10G-LR	✓	✓	✓
SFP-25G-SR-S	✓	✓	✓
SFP-10/25G-LR-S	✓	✓	✓
SFP-10/25G-CSR-S		✓	✓

Table 18 Intel NIC Interoperability with Intel Cables/Optics

Intel Product ID (PID)	HX-PCIE-ID10GF
Intel Direct Attach Cables (DACs)	
XDACBL1M	✓
XDACBL3M	✓
XDACBL5M	✓
Intel Optical Transceivers	

Table 18 Intel NIC Interoperability with Intel Cables/Optics (continued)

E10GSFPSR	✓
E10GSFPLR	✓

The information in the preceding tables was compiled from testing conducted by Cisco Transceiver Module Group (TMG) and vendors. The latest compatibility with optical modules and DACs can be found at <https://tmgmatrix.cisco.com/>.

Refer to the these links for additional connectivity options.

Intel:	Mellanox:
Product Guide	Firmware Release Notes
Speed White Paper	

STEP 11 ORDER GPU CARDS (OPTIONAL)



NOTE: When a GPU is ordered, the server comes with low-profile heatsinks PID (HX-HSLP-M6=) and need to select a special air duct PID (HX-ADGPU-245M6=) for double-wide GPUs.

Select GPU Options

The available GPU PCIe options and their riser slot compatibilities are listed in [Table 17](#)

Table 19 Available PCIe GPU Cards¹

GPU Product ID (PID)	PID Description	Card Size	Max GPU per Node	Riser Slot Compatibility					
				Riser 1A (Gen 4)	Riser 1B ²	Riser 2 (Gen 4)	Riser 3A ³ Gen 4)	Riser 3B ⁴	Riser 3C ^{5,6}
HX-GPU-A10	TESLA A10, PASSIVE, 150W, 24GB	Single-wide	5	slot 2&3	N/A	slot 5&6	N/A	N/A	slot 7
HX-GPU-A30	TESLA A30, PASSIVE, 180W, 24GB	Double-wide	3	slot 2	N/A	slot 5	N/A	N/A	slot 7
HX-GPU-A40 ⁵	TESLA A40 RTX, PASSIVE, 300W, 48GB	Double-wide	3	slot 2	N/A	slot 5	N/A	N/A	slot 7
HX-GPU-A100-80 ⁵	TESLA A100, PASSIVE, 300W, 80GB	Double-wide	3	slot 2	N/A	slot 5	N/A	N/A	slot 7
HX-GPU-A16 ⁵	NVIDIA A16 PCIE 250W 4X16GB	Double-wide	3	slot 2	N/A	slot 5	N/A	N/A	slot 7

Notes:

1. Refer to https://www.cisco.com/content/en/us/td/docs/unified_computing/ucs/c/hw/c240m6/install/b-c240-m6-install-guide.html for more details.
2. Riser 1B does not accept GPUs
3. Riser 3A does not accept GPUs
4. Riser 3B does not accept GPUs
5. The server supports one full-height, full-length, double-wide GPU (PCIe slot 7 only) in Riser 3C.
6. All NVMe server does not support riser 3C

**NOTE:**

- All NVMe server does not support riser 3
 - GPUs cannot be mixed
 - All GPU cards must be procured from Cisco as there is a unique SBIOS ID required by CIMC and UCSM
 - If you are adding GPUs later, please refer to [SPARE PARTS, page 84](#) section of the below spec sheet to find the accessories/cables needed along with the GPU spare.
 - Please refer to [installation guide](#) for the GPU related information.
-

STEP 12 ORDER POWER SUPPLY

Power supplies share a common electrical and physical design that allows for hot-plug and tool-less installation into M6 C-series servers. Each power supply is certified for high-efficiency operation and offer multiple power output options. This allows users to “right-size” based on server configuration, which improves power efficiency, lower overall energy costs and avoid stranded capacity in the data center. Use the power calculator at the following link to determine the needed power based on the options chosen (CPUs, drives, memory, and so on):

<http://ucspowercalc.cisco.com>



WARNING:

- Starting 1st January 2024, only Titanium rated PSUs are allowed to be shipped to European Union (EU), European Economic Area (EEA), United Kingdom (UK), Switzerland and other countries that adopted Lot 9 Regulation.
- DC PSUs are not impacted by Lot 9 Regulation and are EU/UK Lot 9 compliant

Table 20 Power Supply

Product ID (PID)	PID Description
PSU (Input High Line 210VAC)	
HX-PSU1-1050W	UCS 1050W AC PSU Platinum (Not EU/UK Lot 9 Compliant)
HX-PSUV2-1050DC	Cisco UCS 1050W -48V DC Power Supply for Rack Server Requires power cord CAB-48DC-40A-8AWG
HX-PSU1-1200W	1200W Titanium power supply for C-Series Servers
HX-PSU1-1600W	UCS 1600W AC PSU Platinum (Not EU/UK Lot 9 Compliant)
HX-PSU1-2300W ¹	2300W Power supply for Rack servers Titanium
PSU (Input Low Line 110VAC)	
HX-PSU1-1050W	UCS 1050W AC PSU Platinum (Not EU/UK Lot 9 Compliant)
HX-PSUV2-1050DC	Cisco UCS 1050W -48V DC Power Supply for Rack Server Requires power cord CAB-48DC-40A-8AWG
HX-PSU1-2300W	2300W Power supply for Rack servers Titanium
HX-PSU1-1200W	1200W Titanium power supply for C-Series Servers

Notes:

1. The 2300 W power supply uses a different power connector that the rest of the power supplies, so you must use different power cables to connect it. See [Table 21 on page 46](#) and [Table 22 on page 49](#).



NOTE: In a server with two power supplies, both power supplies must be identical.

STEP 13 SELECT INPUT POWER CORD(s)

Using [Table 21](#) and [Table 22](#), select the appropriate AC power cords. You can select a minimum of no power cords and a maximum of two. If you select the option R2XX-DMYPWRCORD, no power cord is shipped with the server.



NOTE: [Table 21](#) lists the power cords for servers that use power supplies less than 2300 W. [Table 22](#) lists the power cords for servers that use 2300 W power supplies. Note that the power cords for 2300 W power supplies use a C19 connector so they only fit the 2300 W power supply connector.

Table 21 Available Power Cords (for server PSUs less than 2300 W)

Product ID (PID)	PID Description	Images
NO-POWER-CORD	ECO friendly green option, no power cable will be shipped	Not applicable
R2XX-DMYPWRCORD	No power cord (dummy PID to allow for a no power cord option)	Not applicable
CAB-48DC-40A-8AWG	C-Series -48VDC PSU Power Cord, 3.5M, 3 Wire, 8AWG, 40A	<p>Figure 1-3 CAB-48DC-40A-8AWG, 00 Power Cord (3.5 m)</p> <p>Plug: R2XX-DMYPWRCORD Conduit rating: 480VDC, 40A</p> <p>Cable: 3.5m</p> <p>Wire Size: 8 AWG</p>
CAB-N5K6A-NA	Power Cord, 200/240V 6A, North America	<p>6'00"</p> <p>60320003</p>
CAB-AC-L620-C13	AC Power Cord, NEMA L6-20 - C13, 2M/6.5ft	<p>3" From Plug End</p> <p>79±2</p>
CAB-C13-CBN	CABASY,WIRE,JUMPER CORD, 27" L, C13/C14, 10A/250V	<p>685 MM ± 25 MM</p> <p>75MM ± 10MM</p> <p>SEE NOTE #3</p> <p>PLUG - TYPE: S318A PID DETAILS: EC: 302-2-2</p> <p>10A/250V</p> <p>CONNECTOR - TYPE: H505 PID DETAILS: EC: 303 B5481</p>
CAB-C13-C14-2M	CABASY,WIRE,JUMPER CORD, PWR, 2 Meter, C13/C14,10A/250V	<p>2.000</p> <p>3" From Plug End</p>

Table 21 Available Power Cords (for server PSUs less than 2300 W)

Product ID (PID)	PID Description	Images
CAB-C13-C14-AC	CORD,PWR,JMP,IEC60320/C14,IEC60320/C13, 3.0M	
CAB-250V-10A-AR	Power Cord, 250V, 10A, Argentina	
CAB-9K10A-AU	Power Cord, 250VAC 10A 3112 Plug, Australia	
CAB-250V-10A-CN	AC Power Cord - 250V, 10A - PRC	
CAB-9K10A-EU	Power Cord, 250VAC 10A CEE 7/7 Plug, EU	
CAB-250V-10A-ID	Power Cord, 250V, 10A, India	
CAB-C13-C14-3M-IN	Power Cord Jumper, C13-C14 Connectors, 3 Meter Length, India	Image not available
CAB-C13-C14-IN	Power Cord Jumper,C13-C14 Connectors,1.4 Meter Length, India	Image not available
CAB-250V-10A-IS	Power Cord, SFS, 250V, 10A, Israel	

Table 21 Available Power Cords (for server PSUs less than 2300 W)

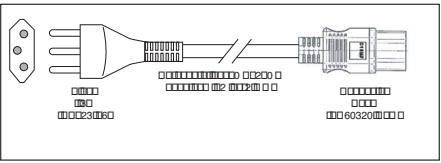
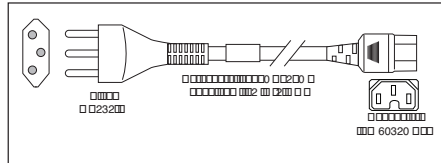
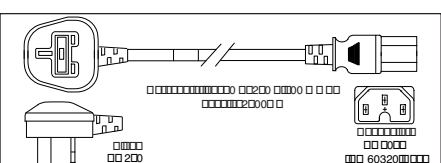
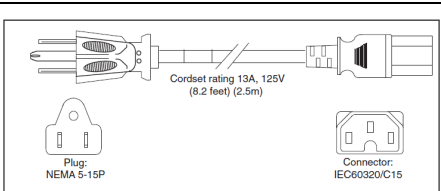
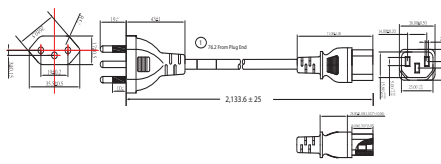
Product ID (PID)	PID Description	Images
CAB-9K10A-IT	Power Cord, 250VAC 10A CEI 23-16/VII Plug, Italy	
CAB-9K10A-SW	Power Cord, 250VAC 10A MP232 Plug, Switzerland	
CAB-9K10A-UK	Power Cord, 250VAC 10A BS1363 Plug (13 A fuse), UK	
CAB-9K12A-NA ¹	Power Cord, 125VAC 13A NEMA 5-15 Plug, North America	
CAB-250V-10A-BR	Power Cord - 250V, 10A - Brazil	
CAB-C13-C14-2M-JP	Power Cord C13-C14, 2M/6.5ft Japan PSE mark	Image not available
CAB-9K10A-KOR ¹	Power Cord, 125VAC 13A KSC8305 Plug, Korea	Image not available
CAB-JPN-3PIN	Japan, 90-125VAC 12A NEMA 5-15 Plug, 2.4m	Image not available
CAB-48DC-40A-INT	C-Series -48VDC PSU PWR Cord, 3.5M, 3 Wire, 8AWG, 40A (INT)	Image not available
CAB-48DC-40A-AS	C-Series -48VDC PSU PWR Cord, 3.5M, 3Wire, 8AWG, 40A (AS/NZ)	Image not available

Notes:

- 1. This power cord is rated to 125V and only supported for PSU rated at 1050W or less

Table 22 Available Power Cords (for servers with 2300 W PSUs)

Product ID (PID)	PID Description	Images
CAB-C19-CBN	Cabinet Jumper Power Cord, 250 VAC 16A, C20-C19 Connectors	Not applicable
CAB-S132-C19-ISRL	S132 to IEC-C19 14ft Israeli	Image not available
CAB-IR2073-C19-AR	IRSM 2073 to IEC-C19 14ft Argen	Image not available
CAB-BS1363-C19-UK	BS-1363 to IEC-C19 14ft UK	Image not available
CAB-SABS-C19-IND	SABS 164-1 to IEC-C19 India	Image not available
CAB-C2316-C19-IT	CEI 23-16 to IEC-C19 14ft Italy	Image not available
CAB-US515P-C19-US	NEMA 5-15 to IEC-C19 13ft US	Image not available
CAB-US520-C19-US	NEMA 5-20 to IEC-C19 14ft US	Image not available
CAB-US620P-C19-US	NEMA 6-20 to IEC-C19 13ft US	Image not available

STEP 14 ORDER TOOL-LESS RAIL KIT AND OPTIONAL REVERSIBLE CABLE MANAGEMENT ARM

Select a Tool-less Rail Kit

Select a tool-less rail kit (or no rail kit) from [Table 23](#).

Table 23 Tool-less Rail Kit Options

Product ID (PID)	PID Description
HX-RAIL-M6	Ball bearing rail kit
HX-RAIL-NONE	No rail kit option



NOTE: Cisco recommends a minimum quantity of 1 Rail Kit.

Select an Optional Reversible Cable Management Arm

The reversible cable management arm mounts on either the right or left slide rails at the rear of the server and is used for cable management. Use [Table 24](#) to order a cable management arm.

Table 24 Cable Management Arm

Product ID (PID)	PID Description
HX-CMA-C240M6	Reversible CMA for ball bearing rail kit

For more information about the tool-less rail kit and cable management arm, see the *Cisco HyperFlex HX245C M6SX All Flash and Hybrid Server Nodes Installation and Service Guide* at this URL:

https://www.cisco.com/content/en/us/td/docs/unified_computing/ucs/c/hw/c245m6/install/c245m6.html



NOTE: If you plan to rackmount your Cisco HyperFlex HX245C M6SX All Flash and Hybrid Server Nodes, you must order a tool-less rail kit. The same rail kits and CMAs are used for M5 and M6 servers.

STEP 15 ORDER SECURITY DEVICES (OPTIONAL)

A Trusted Platform Module (TPM) is a computer chip (microcontroller) that can securely store artifacts used to authenticate the platform (server). These artifacts can include passwords, certificates, or encryption keys. A TPM can also be used to store platform measurements that help ensure that the platform remains trustworthy. Authentication (ensuring that the platform can prove that it is what it claims to be) and attestation (a process helping to prove that a platform is trustworthy and has not been breached) are necessary steps to ensure safer computing in all environments.

A chassis intrusion switch gives a notification of any unauthorized mechanical access into the server.

The security device ordering information is listed in [Table 25](#).

Table 25 Security Devices

Product ID (PID)	PID Description
UCSX-TPM2-002B-C	Trusted Platform Module 2.0 for UCS servers
HX-INT-SW02	Chassis Intrusion Switch
UCSX-TPM-OPT-OUT	OPT OUT, TPM 2.0, TCG, FIPS140-2, CC EAL4+ Certified ¹

Notes:

1. Please note that Microsoft certification requires a TPM 2.0 for bare-metal or guest VM deployments. Opt-out of the TPM 2.0 voids the Microsoft certification



NOTE:

- The TPM module used in this system conforms to TPM v2.0, as defined by the Trusted Computing Group (TCG). It is also SPI-based.
- TPM installation is supported after-factory. However, a TPM installs with a one-way screw and cannot be replaced, upgraded, or moved to another server. If a server with a TPM is returned, the replacement server must be ordered with a new TPM.

STEP 16 ORDER TOOL-LESS RAIL KIT AND OPTIONAL REVERSIBLE CABLE MANAGEMENT ARM

Select a Tool-less Rail Kit

Select a tool-less rail kit (or no rail kit) from [Table 26](#).

Table 26 Tool-less Rail Kit Options

Product ID (PID)	PID Description
HX-RAIL-M6	Ball Bearing Rail Kit for C220 & C240 M6 rack servers
HX-RAIL-NONE	No rail kit option



NOTE: Cisco recommends a minimum quantity of 1 Rail Kit.

Select an Optional Reversible Cable Management Arm

The reversible cable management arm mounts on either the right or left slide rails at the rear of the server and is used for cable management. Use [Table 27](#) to order a cable management arm.

Table 27 Cable Management Arm

Product ID (PID)	PID Description
HX-CMA-C240M6	Reversible CMA for C240 M6 ball bearing rail kit

For more information about the tool-less rail kit and cable management arm, see the Cisco server Installation and Service Guide at this URL:

https://www.cisco.com/content/en/us/td/docs/unified_computing/ucs/c/hw/c240m6/install/c240m6.html



NOTE: If you plan to rackmount your HyperFlex HX245C M6 All Flash/Hybrid Server Nodes, you must order a tool-less rail kit. The same rail kits and CMAs are used for M5 and M6 servers.

STEP 17 ORDER SECURITY DEVICES (OPTIONAL)

A Trusted Platform Module (TPM) is a computer chip (microcontroller) that can securely store artifacts used to authenticate the platform (server). These artifacts can include passwords, certificates, or encryption keys. A TPM can also be used to store platform measurements that help ensure that the platform remains trustworthy. Authentication (ensuring that the platform can prove that it is what it claims to be) and attestation (a process helping to prove that a platform is trustworthy and has not been breached) are necessary steps to ensure safer computing in all environments.

A chassis intrusion switch gives a notification of any unauthorized mechanical access into the server.

The security device ordering information is listed in [Table 28](#).

Table 28 Security Devices

Product ID (PID)	PID Description
HX-TPM2-002B-C	Trusted Platform Module 2.0 UCS servers (FIPS 140-2 Compliant)
HX-INT-SW02	C220 and C240 M6 Chassis Intrusion Switch
UCSX-TPM-OPT-OUT	OPT OUT, TPM 2.0, TCG, FIPS140-2, CC EAL4+ Certified ¹

Notes:

1. Please note that Microsoft certification requires a TPM 2.0 for bare-metal or guest VM deployments. Opt-out of the TPM 2.0 voids the Microsoft certification



NOTE:

- The TPM module used in this system conforms to TPM 2.0, as defined by the Trusted Computing Group (TCG). It is also SPI-based.
- TPM installation is supported after-factory. However, a TPM installs with a one-way screw and cannot be replaced, upgraded, or moved to another server. If a server with a TPM is returned, the replacement server must be ordered with a new TPM.

STEP 18 SELECT LOCKING SECURITY BEZEL (OPTIONAL)

An optional locking bezel can be mounted to the front of the chassis to prevent unauthorized access to the drives.

Select the locking bezel from [Table 29](#).

Table 29 Locking Bezel Option

Product ID (PID)	Description
HXAF240C-BZL-M5SX	HXAF240C M5 Security Bezel
HX240C-BZL-M5S	HX240C M5 Security Bezel

STEP 19 SELECT HOST OPERATING SYSTEM

Select Microsoft Windows operating system as desired from [Table 30](#)



NOTE:

- **VMware ESXi Hypervisor** - We no longer ship VMWare ESXi from the factory. Refer to this link for the further details.
https://www.cisco.com/c/en/us/td/docs/hyperconverged_systems/HyperFlex_HX_DataPlatformSoftware/BroadcomAgreementNotice/b-broadcom-terminated-vmware-embedded-agreement.html
- **Microsoft operating system** - Optional guest OS licenses that may be purchased to run on top of the hypervisor.

Table 30 Host Operation System

Product ID (PID)	PID Description
Operating system	
Microsoft Options	
HX-MSWS-22-ST16C	Windows Server 2022 Standard (16 Cores/2 VMs)
HX-MSWS-22-DC16C	Windows Server 2022 Data Center (16 Cores/Unlimited VMs)

STEP 20 SELECT HYPERFLEX DATA PLATFORM (HXDP) SOFTWARE

HyperFlex Data Platform Edition & Subscription Period options are available as follows.

Product ID (PID)	
HXDP-SW	Cisco HyperFlex Data Platform Software

Select as desired option from [Table 31](#)

Table 31 HX Data Platform Software

Product ID (PID)	PID Description
Cisco HyperFlex Data Platform Software	
HXDP-DC-AD	HyperFlex Data Platform Data center Advantage (1 to 5) Yr
HXDP-DC-PR	HyperFlex Data Platform Data center Premier (1 to 5) Yr
Cisco HyperFlex Data Platform Software - SLR	
HXDP-DC-AD-SLR	HyperFlex Data Platform Data center Advantage SLR (1 to 5) Yr
HXDP-DC-PR-SLR	HyperFlex Data Platform Data center Premier SLR (1 to 5) Yr
Cisco HyperFlex Data Platform Software Support	
SVS-DCM-SUPT-BAS	Basic Support for DCM
SVS-SSTCS-DCMGMT	Solution Support for DC Mgmt
SVS-L1DCS-HXDP	CXL1 for HXDP
SVS-L2DCS-HXDP	CXL2 for HXDP

STEP 21 CISCO INTERSIGHT

Cisco Intersight™ is a Software-as-a-Service (SaaS) hybrid cloud operations platform which delivers intelligent automation, observability, and optimization to customers for traditional and cloud-native applications and infrastructure.

Product ID (PID)	
DC-MGT-SAAS	Cisco Intersight SaaS

Select as desired option from [Table 32](#).

Table 32 Cisco Intersight

Product ID (PID)	PID Description
Cisco Intersight - SaaS	
DC-MGT-SAAS-EST-C	Cisco Intersight SaaS - Essentials (1 to 5) Yr
DC-MGT-SAAS-AD-C	Cisco Intersight SaaS - Advantage (new) (1 to 5) Yr
DC-MGT-SAAS-PR-C	Cisco Intersight SaaS - Premier (1 to 5) Yr
Cisco Intersight - Connected Virtual Appliance	
DC-MGT-ONPREM-EST	Cisco Intersight Connected Virtual Appliance - Essentials (1 to 5) Yr
DC-MGT-VAPP-AD	Cisco Intersight Connected Virtual Appliance - Advantage (1 to 5) Yr
DC-MGT-VAPP-PR	Cisco Intersight Connected Virtual Appliance - Premier (1 to 5) Yr
Cisco Intersight - Private Virtual Appliance	
DC-MGT-PVAPP-EST	Cisco Intersight Private Virtual Appliance - Essentials (1 to 5) Yr
DC-MGT-PVAPP-AD	Cisco Intersight Private Virtual Appliance - Advantage (1 to 5) Yr
DC-MGT-PVAPP-PR	Cisco Intersight Private Virtual Appliance - Premier (1 to 5) Yr
Cisco Intersight Support	
SVS-DCM-SUPT-BAS	Basic Support for DCM
SVS-SSTCS-DCMGMT	Solution Support for DC Mgmt
SVS-L1DCS-INTER	CXL1 for INTERSIGHT
SVS-L2DCS-INTER	CXL2 for INTERSIGHT

STEP 22 SELECT SERVICE and SUPPORT LEVEL

A variety of service options are available, as described in this section.

Unified Computing Warranty, No Contract

If you have noncritical implementations and choose to have no service contract, the following coverage is supplied:

- Three-year parts coverage.
- Next business day (NBD) parts replacement eight hours a day, five days a week.
- 90-day software warranty on media.
- Ongoing downloads of BIOS, drivers, and firmware updates.
- UCSM updates for systems with Unified Computing System Manager. These updates include minor enhancements and bug fixes that are designed to maintain the compliance of UCSM with published specifications, release notes, and industry standards.

Smart Net Total Care (SNTC) for Cisco UCS

For support of the entire Unified Computing System, Cisco offers the Cisco Smart Net Total Care (SNTC) for UCS Service. This service provides expert software and hardware support to help sustain performance and high availability of the unified computing environment. Access to Cisco Technical Assistance Center (TAC) is provided around the clock, from anywhere in the world.

The Cisco Smart Net Total Care for UCS Service includes flexible hardware replacement options, including replacement in as little as two hours. There is also access to Cisco's extensive online technical resources to help maintain optimal efficiency and uptime of the unified computing environment. For more information please refer to the following URL:

<http://www.cisco.com/c/en/us/services/technical/smart-net-total-care.html?stickynav=1>

You can choose a desired service listed in [Table 33](#).

Table 33 Cisco SNTC for UCS Service (PID HXAF245C-M6SX)

Service SKU	Service Level GSP	On Site?	Description
CON-PREM-HXAF245C	C2P	Yes	SNTC 24X7X20S
CON-UCSD8-HXAF245C	UCSD8	Yes	UC SUPP DR 24X7X20S*
CON-C2PL-HXAF245C	C2PL	Yes	LL 24X7X20S**
CON-OSP-HXAF245C	C4P	Yes	SNTC 24X7X40S
CON-UCSD7-HXAF245C	UCSD7	Yes	UCS DR 24X7X40S*
CON-C4PL-HXAF245C	C4PL	Yes	LL 24X7X40S**

Table 33 Cisco SNTC for UCS Service (PID HXAF245C-M6SX) (continued)

Service SKU	Service Level GSP	On Site?	Description
CON-USD7L-HXAF245C	USD7L	Yes	LLUCS HW DR 24X7X4OS***
CON-OSE-HXAF245C	C4S	Yes	SNTC 8X5X4OS
CON-UCSD6-HXAF245C	UCSD6	Yes	UC SUPP DR 8X5X4OS*
CON-SNCO-HXAF245C	SNCO	Yes	SNTC 8x7xNCDOS****
CON-OS-HXAF245C	CS	Yes	SNTC 8X5XNBDOS
CON-UCSD5-HXAF245C	UCSD5	Yes	UCS DR 8X5XNBDOS*
CON-S2P-HXAF245C	S2P	No	SNTC 24X7X2
CON-S2PL-HXAF245C	S2PL	No	LL 24X7X2**
CON-SNTP-HXAF245C	SNTP	No	SNTC 24X7X4
CON-SNTPL-HXAF245C	SNTPL	No	LL 24X7X4**
CON-SNTE-HXAF245C	SNTE	No	SNTC 8X5X4
CON-SNC-HXAF245C	SNC	No	SNTC 8x7xNCD
CON-SNT-HXAF245C	SNT	No	SNTC 8X5XNBD
CON-SW-HXAF245C	SW	No	SNTC NO RMA
Note: For PID HXAF245C-M6SX, select Service SKU with HX245CSM suffix (Example: CON-OSP-HX245CSM)			
*Includes Drive Retention (see below for full description)			
**Includes Local Language Support (see below for full description) – Only available in China and Japan			
***Includes Local Language Support and Drive Retention – Only available in China and Japan			

Smart Net Total Care (SNTC) for Cisco UCS Onsite Troubleshooting Service

An enhanced offer over traditional Smart Net Total Care which provides onsite troubleshooting expertise to aid in the diagnostics and isolation of hardware issue within our customers' Cisco Unified Computing System (UCS) environment. It is delivered by a Cisco Certified field engineer (FE) in collaboration with remote TAC engineer and Virtual Internetworking Support Engineer (VISE). You can choose a desired service listed in [Table 34](#).

Table 34 SNTC for UCS Onsite Troubleshooting Service (PID HXAF245C-M6SX)

Service SKU	Service Level GSP	On Site?	Description
CON-OSPT-HXAF245C	OSPT	Yes	24X7X40S Trblshtg
CON-OSPTD-HXAF245C	OSPTD	Yes	24X7X40S TrblshtgDR*
CON-OSPTL-HXAF245C	OSPTL	Yes	24X7X40S TrblshtgLL**
CON-OPTLD-HXAF245C	OPTLD	Yes	24X7X40S TrblshtgLLD***
For PID HX245C-M6-CH, select Service SKU with UCSB2M6C suffix (Example: CON-OSPT-UCSB2M6C)			
*Includes Drive Retention (see below for full description)			
**Includes Local Language Support (see below for full description) – Only available in China and Japan			
***Includes Local Language Support and Drive Retention – Only available in China and Japan			

Solution Support (SSPT) for UCS

Solution Support includes both Cisco product support and solution-level support, resolving complex issues in multivendor environments, on average, 43% more quickly than product support alone. Solution Support is a critical element in data center administration, to help rapidly resolve any issue encountered, while maintaining performance, reliability, and return on investment.

This service centralizes support across your multivendor Cisco environment for both our products and solution partner products you’ve deployed in your ecosystem. Whether there is an issue with a Cisco or solution partner product, just call us. Our experts are the primary point of contact and own the case from first call to resolution. For more information please refer to the following URL:

<http://www.cisco.com/c/en/us/services/technical/solution-support.html?stickynav=1>

You can choose a desired service listed in *Table 35*.

Table 35 Solution Support for UCS Service (PID HXAF245C-M6SX)

Service SKU	Service Level GSP	On Site?	Description
CON-SSC2P-HXAF245C	SSC2P	Yes	SOLN SUPP 24X7X2OS
CON-SSC4P-HXAF245C	SSC4P	Yes	SOLN SUPP 24X7X4OS
CON-SSC4S-HXAF245C	SSC4S	Yes	SOLN SUPP 8X5X4OS
CON-SSCS-HXAF245C	SSCS	Yes	SOLN SUPP 8X5XNBDOS
CON-SSDR7-HXAF245C	SSDR7	Yes	SSPT DR 24X7X4OS*
CON-SSDR5-HXAF245C	SSDR5	Yes	SSPT DR 8X5XNBDOS*
CON-SSS2P-HXAF245C	SSS2P	No	SOLN SUPP 24X7X2
CON-SSSNP-HXAF245C	SSSNP	No	SOLN SUPP 24X7X4
CON-SSSNE-HXAF245C	SSSNE	No	SOLN SUPP 8X5X4
CON-SSSNC-HXAF245C	SSSNC	No	SOLN SUPP NCD
CON-SSSNT-HXAF245C	SSSNT	No	SOLN SUPP 8X5XNBD
*Includes Drive Retention (see below for full description)			

Solution Support for Service Providers

You can choose a desired service listed in [Table 36](#).

Table 36 Solution Support for Service Providers UCS Service (PID HXAF245C-M6SX)

Service SKU	Service Level GSP	On Site?	Description
SP-SSC2P-HXAF245C	SPSSC2P	Yes	SP SOLN SUPP 24X7X2OS
SP-SSC4P-HXAF245C	SPSSC4P	Yes	SP SOLN SUPP 24X7X4OS
SP-SSC4S-HXAF245C	SPSSC4S	Yes	SP SOLN SUPP 8X5X4OS
SP-SSCS-HXAF245C	SPSSCS	Yes	SP SOLN SUPP 8X5XNBDOS
SP-SSS2P-HXAF245C	SPSSS2P	Yes	SP SOLN SUPP 24X7X2
SP-SSS4P-HXAF245C	SPSSS4P	Yes	SP SOLN SUPP 24X7X4
SP-SSSNE-HXAF245C	SPSSSNE	No	SP SOLN SUPP 8X5X4
SP-SSSNT-HXAF245C	SPSSSNT	No	SP SOLN SUPP 8X5XNBD
SP-SSSPB-HXAF245C	SPSSSPB	No	SP SOLN SUPP NO HW RPL

Note: For PID HXAF245C-M6SX, select Service SKU with HX245CSM suffix (Example: CON-SPSSC4P-HX245CSM)

Smart Net Total Care for UCS Hardware Only Service

For faster parts replacement than is provided with the standard Cisco Unified Computing System warranty, Cisco offers the Cisco Smart Net Total Care for UCS Hardware Only Service. You can choose from two levels of advanced onsite parts replacement coverage in as little as four hours. Smart Net Total Care for UCS Hardware Only Service provides remote access any time to Cisco support professionals who can determine if a return materials authorization (RMA) is required. You can choose a desired service listed in [Table 37](#).

Table 37 SNTC for UCS Hardware Only Service (PID HXAF245C-M6SX)

Service SKU	Service Level GSP	On Site?	Description
CON-UCW7-HXAF245C	UCW7	Yes	UCS HW 24X7X4OS
CON-UCWD7-HXAF245C	UCWD7	Yes	UCS HW+DR 24X7X4OS*
CON-UCW7L-HXAF245C	UCW7L	Yes	LL UCS 24X7X4OS**
CON-UWD7L-HXAF245C	UWD7L	Yes	LL UCS DR 24X7X4OS***
CON-UCW5-HXAF245C	UCW5	Yes	UCS HW 8X5XNBDOS
CON-UCWD5-HXAF245C	UCWD5	Yes	UCS HW+DR 8X5XNBDOS*

Table 37 SNTC for UCS Hardware Only Service (PID HXAF245C-M6SX) (continued)

Note: For PID HXAF245C-M6SX, select Service SKU with HX245CSM suffix (Example: CON-UCW7-HX245CSM)
*Includes Drive Retention (see below for full description)
**Includes Local Language Support (see below for full description) – Only available in China and Japan
***Includes Local Language Support and Drive Retention – Only available in China and Japan

Partner Support Service for UCS

Cisco Partner Support Service (PSS) is a Cisco Collaborative Services service offering that is designed for partners to deliver their own branded support and managed services to enterprise customers. Cisco PSS provides partners with access to Cisco's support infrastructure and assets to help them:

- Expand their service portfolios to support the most complex network environments
- Lower delivery costs
- Deliver services that increase customer loyalty

PSS options enable eligible Cisco partners to develop and consistently deliver high-value technical support that capitalizes on Cisco intellectual assets. This helps partners to realize higher margins and expand their practice. PSS is available to all Cisco PSS partners. The two Partner Unified Computing Support Options include:

- Partner Support Service for UCS
- Partner Support Service for UCS Hardware Only

PSS for UCS provides hardware and software support, including triage support for third party software, backed by Cisco technical resources and level three support. You can choose a desired service listed in [Table 38](#).

Table 38 PSS for UCS Service (PID HXAF245C-M6SX)

Service SKU	Service Level GSP	On Site?	Description
CON-PSJ8-HXAF245C	PSJ8	Yes	UCS PSS 24X7X2 OS
CON-PSJ7-HXAF245C	PSJ7	Yes	UCS PSS 24X7X4 OS
CON-PSJD7-HXAF245C	PSJD7	Yes	UCS PSS 24X7X4 DR*
CON-PSJ6-HXAF245C	PSJ6	Yes	UCS PSS 8X5X4 OS
CON-PSJD6-HXAF245C	PSJD6	Yes	UCS PSS 8X5X4 DR*
CON-PSJ4-HXAF245C	PSJ4	No	UCS SUPP PSS 24X7X2
CON-PSJ3-HXAF245C	PSJ3	No	UCS SUPP PSS 24X7X4
CON-PSJ2-HXAF245C	PSJ2	No	UCS SUPP PSS 8X5X4
CON-PSJ1-HXAF245C	PSJ1	No	UCS SUPP PSS 8X5XNBD

Table 38 PSS for UCS Service (PID HXAF245C-M6SX) (continued)

Note: For PID HXAF245C-M6SX, select Service SKU with HX245CSM suffix (Example: CON-PSJ7-HX245CSM)
*Includes Drive Retention (see below for full description)

PSS for UCS Hardware Only

PSS for UCS Hardware Only provides customers with replacement parts in as little as two hours and provides remote access any time to Partner Support professionals who can determine if a return materials authorization (RMA) is required. You can choose a desired service listed in [Table 39](#).

Table 39 PSS for UCS Hardware Only Service (PID HXAF245C-M6SX)

Service SKU	Service Level GSP	On Site?	Description
CON-PSW7-HXAF245C	PSW7	Yes	UCS W PSS 24X7X4 OS
CON-PSWD7-HXAF245C	PSWD7	Yes	UCS W PSS 24X7X4 DR*
CON-PSW6-HXAF245C	PSW6	Yes	UCS W PSS 8X5X4 OS
CON-PSWD6-HXAF245C	PSWD6	Yes	UCS W PSS 8X5X4 DR*
CON-PSW4-HXAF245C	PSW4	No	UCS W PL PSS 24X7X2
CON-PSW3-HXAF245C	PSW3	No	UCS W PL PSS 24X7X4
CON-PSW2-HXAF245C	PSW2	No	UCS W PL PSS 8X5X4
Note: For PID HXAF245C-M6SX, select Service SKU with HX245CSM suffix (Example: CON-PSW7-HX245CSM)			
*Includes Drive Retention (see below for full description)			

Distributor Support Service (DSS)

You can choose a desired service listed in [Table 40](#).

Table 40 DSS for UCS Service (PID HXAF245C-M6SX)

Service SKU	Service Level GSP	On Site?	Description
CON-DSCO-HXAF245C	DSCO	Yes	DSS CORE 24X7X20S
CON-DSO-HXAF245C	DSO	Yes	DSS CORE 24X7X4
CON-DSNO-HXAF245C	DSNO	Yes	DSS CORE 8X5XNBDOS
CON-DSCC-HXAF245C	DSCC	No	DSS CORE 24X7X2
CON-DCP-HXAF245C	DCP	No	DSS CORE 24X7X4
CON-DSE-HXAF245C	DSE	No	DSS CORE 8X5X4
CON-DSN-HXAF245C	DSN	No	DSS CORE 8X5XNBD

Note: For PID HXAF245C-M6SX, select Service SKU with HX245CSM suffix (Example: CON-DSO-HX245CSM)

Unified Computing Combined Support Service

Combined Services makes it easier to purchase and manage required services under one contract. SNTC services for UCS help increase the availability of your vital data center infrastructure and realize the most value from your unified computing investment. The more benefits you realize from the Cisco Unified Computing System (Cisco UCS), the more important the technology becomes to your business. These services allow you to:

- Optimize the uptime, performance, and efficiency of your UCS
- Protect your vital business applications by rapidly identifying and addressing issues
- Strengthen in-house expertise through knowledge transfer and mentoring
- Improve operational efficiency by allowing UCS experts to augment your internal staff resources
- Enhance business agility by diagnosing potential issues before they affect your operations

You can choose a desired service listed [Table 41](#).

Table 41 Combined Support for UCS Service (PID HXAF245C-M6SX)

Service SKU	Service Level GSP	On Site?	Description
CON-NCF2P-HXAF245C	NCF2P	Yes	CMB SVC 24X7X2OS
CON-NCF4P-HXAF245C	NCF4P	Yes	CMB SVC 24X7X4OS
CON-NCF4S-HXAF245C	NCF4S	Yes	CMB SVC 8X5X4OS
CON-NCFC5-HXAF245C	NCFC5	Yes	CMB SVC 8X5XNBDOS
CON-NCF2-HXAF245C	NCF2	No	CMB SVC 24X7X2
CON-NCFP-HXAF245C	NCFP	No	CMB SVC 24X7X4
CON-NCFE-HXAF245C	NCFE	No	CMB SVC 8X5X4
CON-NCFT-HXAF245C	NCFT	No	CMB SVC 8X5XNBD
CON-NCFW-HXAF245C	NCFW	No	CMB SVC SW
Note: For PID HXAF245C-M6SX, select Service SKU with HX245CSM suffix (Example: CON-NCF4P-HX245CSM)			

UCS Drive Retention Service

With the Cisco Unified Computing Drive Retention Service, you can obtain a new disk drive in exchange for a faulty drive without returning the faulty drive.

Sophisticated data recovery techniques have made classified, proprietary, and confidential information vulnerable, even on malfunctioning disk drives. The Drive Retention service enables you to retain your drives and ensures that the sensitive data on those drives is not compromised, which reduces the risk of any potential liabilities. This service also enables you to comply with regulatory, local, and federal requirements.

If your company has a need to control confidential, classified, sensitive, or proprietary data, you might want to consider one of the Drive Retention Services listed in the above tables (where available).



NOTE: Cisco does not offer a certified drive destruction service as part of this service.

Local Language Technical Support for UCS

Where available, and subject to an additional fee, local language support for calls on all assigned severity levels may be available for specific product(s) - see tables above.

For a complete listing of available services for Cisco Unified Computing System, see the following URL:

http://www.cisco.com/en/US/products/ps10312/serv_group_home.html

SUPPLEMENTAL MATERIAL

Hyperconverged Systems

Cisco HyperFlex Systems let you unlock the full potential of hyperconvergence and adapt IT to the needs of your workloads. The systems use an end-to-end software-defined infrastructure approach, combining software-defined computing in the form of Cisco HyperFlex HX-Series nodes; software-defined storage with the powerful Cisco HX Data Platform; and software-defined networking with the Cisco UCS fabric that will integrate smoothly with Cisco Application Centric Infrastructure (Cisco ACI). Together with a single point of connectivity and management, these technologies deliver a preintegrated and adaptable cluster with a unified pool of resources that you can quickly deploy, adapt, scale, and manage to efficiently power your applications and your business.

Figure 7 & Figure 8 show a small footprint cluster.

Figure 7 Small Footprint Cluster Using HX245 All Flash/Hybrid Server Nodes With Data Center Fabric Interconnect Deployment Mode

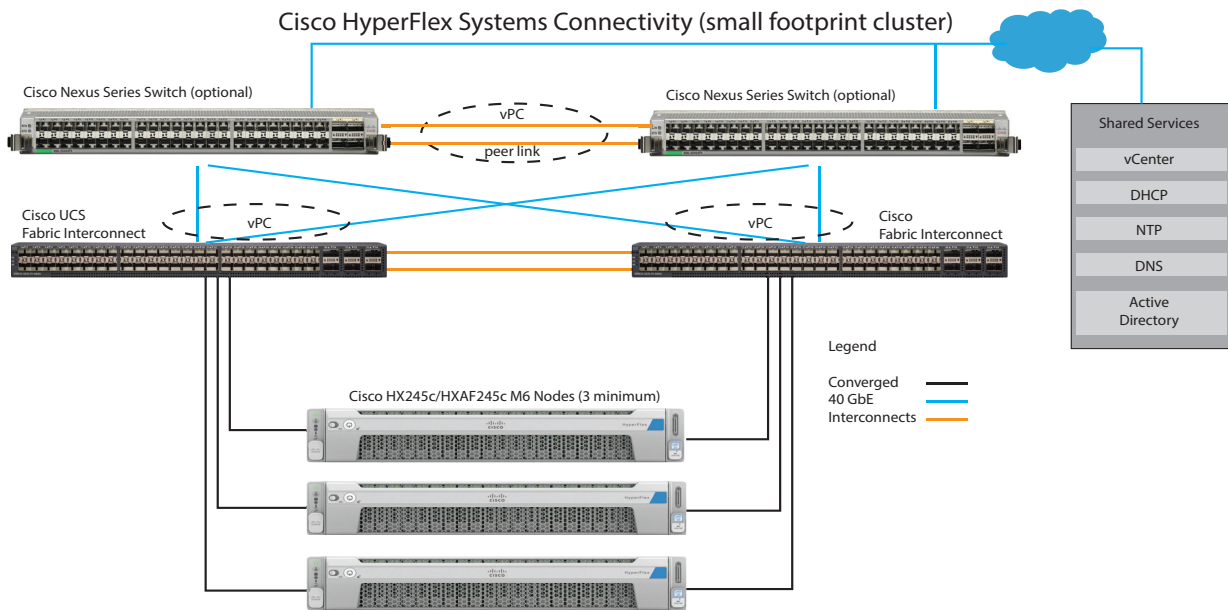
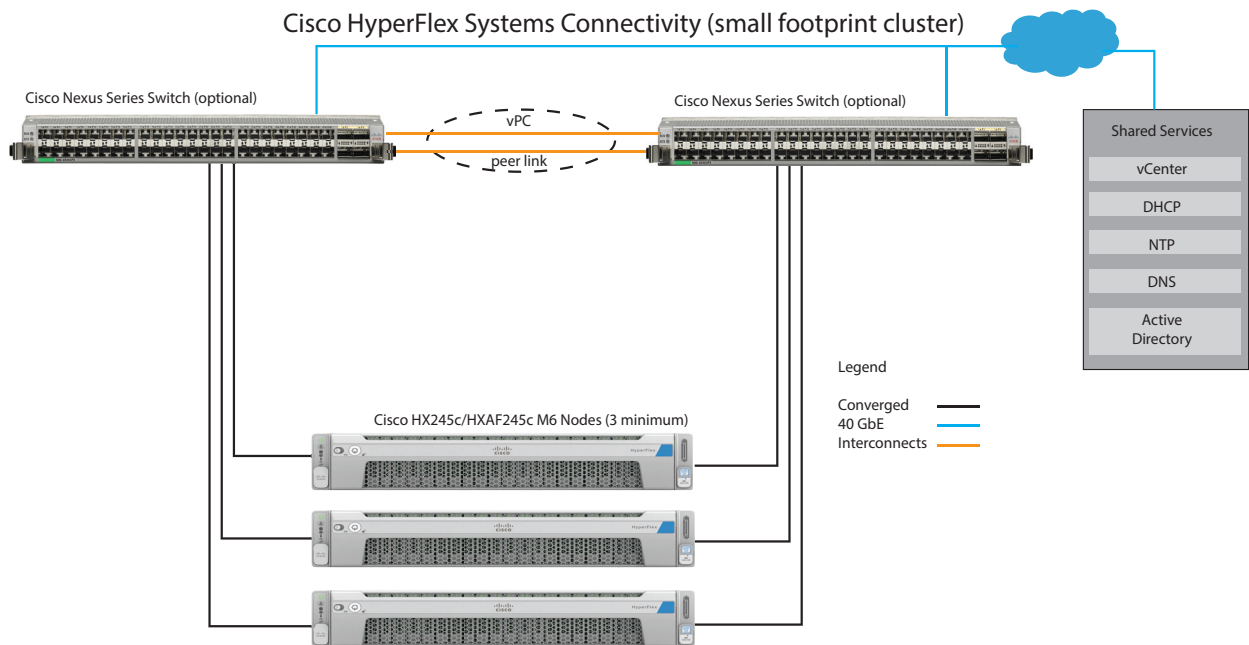

Figure 8 Small Footprint Cluster Using HX245 M6 All Flash/Hybrid Server Nodes Data Center Without Fabric Interconnect Deployment Mode



NIC Based 10 or 25 Gigabit Ethernet Dual Switch Topology (quad port)

Dual switch configuration provides a slightly more complex topology with full redundancy that protects against: switch failure, link failure, and port failure. It requires two switches that may be standalone or stacked, and four 10/25GE ports, one 1GE port for CIMC management, and 1 x quad port NIC per server. Trunk ports are the only supported network port configuration. refer [10/25 Gigabit Ethernet Switch Configuration Guidelines](#) for more information.

To deploy this topology, select connectivity mode from [Table 13](#).

Figure 9 Physical cabling for the Quad Port NIC Based 10/25GE Dual Switch Topology.

3 or greater Node Edge/DC-no-FI - Dual 10/25GE



Dual 10/25GE ToR Switches (standalone or stacked)

Intel X710 quad-port 10G / Cisco-Intel E810XXVDA4L 4x25/10G

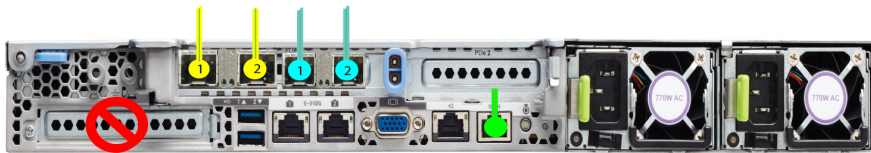

x3 or x4 for edge
x3 and up to 12 for DC-no-FI

- Legend
- HX/ESXi Management
 - HX storage data
 - CIMC port

NIC Based 10 or 25 Gigabit Ethernet Dual Switch Topology (dual port)

Dual switch configuration provides a slightly more complex topology with full redundancy that protects against: switch failure, link failure, and port failure. It requires two switches that may be standalone or stacked, and four 10/25GE ports, one 1GE port for CIMC management, and 2 x dual port NIC per server. Trunk ports are the only supported network port configuration. refer [10/25 Gigabit Ethernet Switch Configuration Guidelines](#) for more information.

To deploy this topology, select connectivity mode from [Table 13](#).

Figure 10 Physical cabling for the Dual Port NIC Based 10/25GE Dual Switch Topology.

3 or greater Node Edge/DC-no-FI - Dual 10/25GE

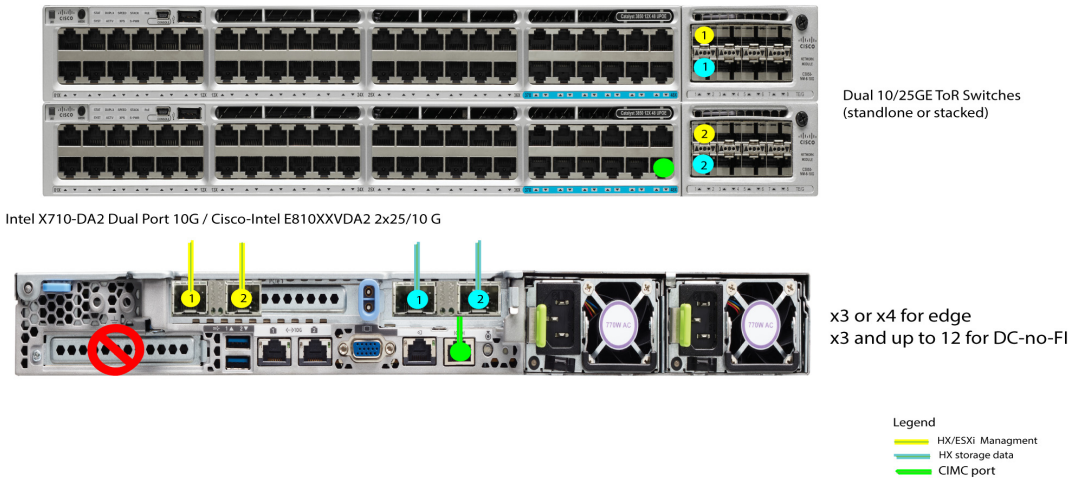

Chassis

An internal view of the Cisco HyperFlex HX245C M6SX All Flash and Hybrid Server Nodes chassis with the top cover removed is shown in [Figure 11](#).

Figure 11 Cisco HyperFlex HX245C M6SX All Flash and Hybrid Server Nodes With Top Cover Off

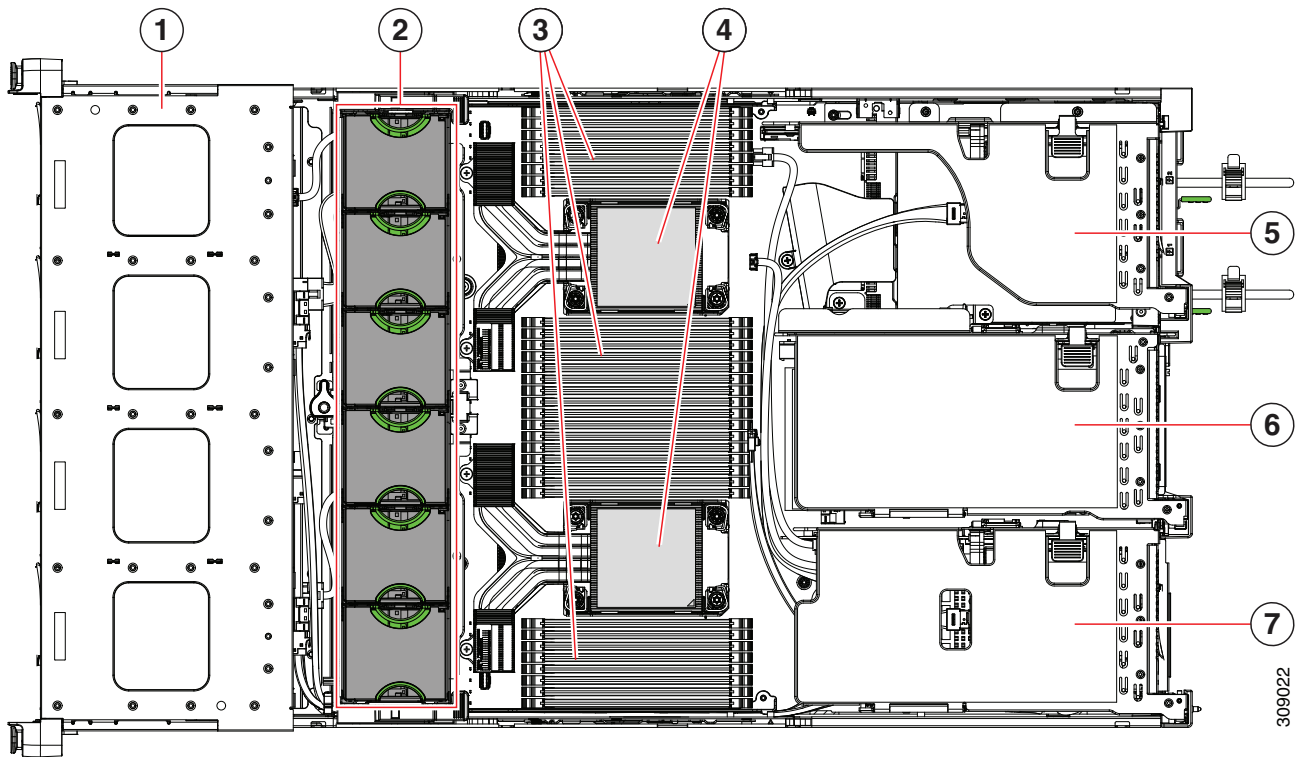

1	Front-loading drive bays.	2	Cooling fan modules (six, hot-swappable)
3	DIMM sockets on motherboard (16 per CPU) An air baffle rests on top of the DIMMs and CPUs when the server is operating. The air baffle is not displayed in this illustration.	4	CPU sockets CPU 2 is at the top and CPU 1 is at the bottom.

<p>5</p>	<p>PCIe riser 3 (PCIe slots 7 and 8 numbered from bottom to top), with the following options:</p> <ul style="list-style-type: none"> ■ 3A (Default Option)—Slots 7 (x24 mechanical, x8 electrical), and 8 (x24 mechanical, x8 electrical). Both slots can accept a full height, full length GPU card. ■ 3B (Storage Option)—Slots 7 (x24 mechanical, x4 electrical) and 8 (x24 mechanical, x4 electrical). Both slots can accept 2.5-inch NVMe SSDs. ■ 3C (GPU Option)—Slots 7 (x24 mechanical, x16 electrical) and 8 empty (NCSI support limited to one slot at a time). Slot 7 can support a full height, full length, double-wide GPU card and 8 blocked by Double-wide GPU (not used) 	<p>6</p>	<p>PCIe riser 2 (PCIe slots 4, 5, 6 numbered from bottom to top), with the following options:</p> <ul style="list-style-type: none"> ■ 2A (Default Option)—Slot 4 (x24 mechanical, x8 electrical) supports full height, ¾ length card; Slot 5 (x24 mechanical, x16 electrical) supports full height, full length GPU card; Slot 6 (x24 mechanical, x8 electrical) supports full height, full length card.
<p>7</p>	<p>PCIe riser 1 (PCIe slot 1, 2, 3 numbered bottom to top), with the following options:</p> <ul style="list-style-type: none"> ■ 1A (Default Option)—Slot 1 (x24 mechanical, x8 electrical) supports full height, ¾ length card; Slot 2 (x24 mechanical, x16 electrical) supports full height, full length GPU card; Slot 3 (x24 mechanical, x8 electrical) supports full height, full length card. ■ 1B (Storage Option)—Slot 1 is reserved; Slot 2 (x4 electrical), supports 2.5-inch SFF NVMe SSDs; Slot 3 (x4 electrical), supports 2.5-inch SFF NVMe SSDs. 	<p>-</p>	

Riser Connector Locations on the Motherboard

Figure 12 shows the locations of the PCIe riser connectors on the HyperFlex HX245C M6SX All Flash and Hybrid Server Nodes motherboard.

Figure 12 HyperFlex HX245C M6SX All Flash and Hybrid Server Nodes Riser Connector Locations

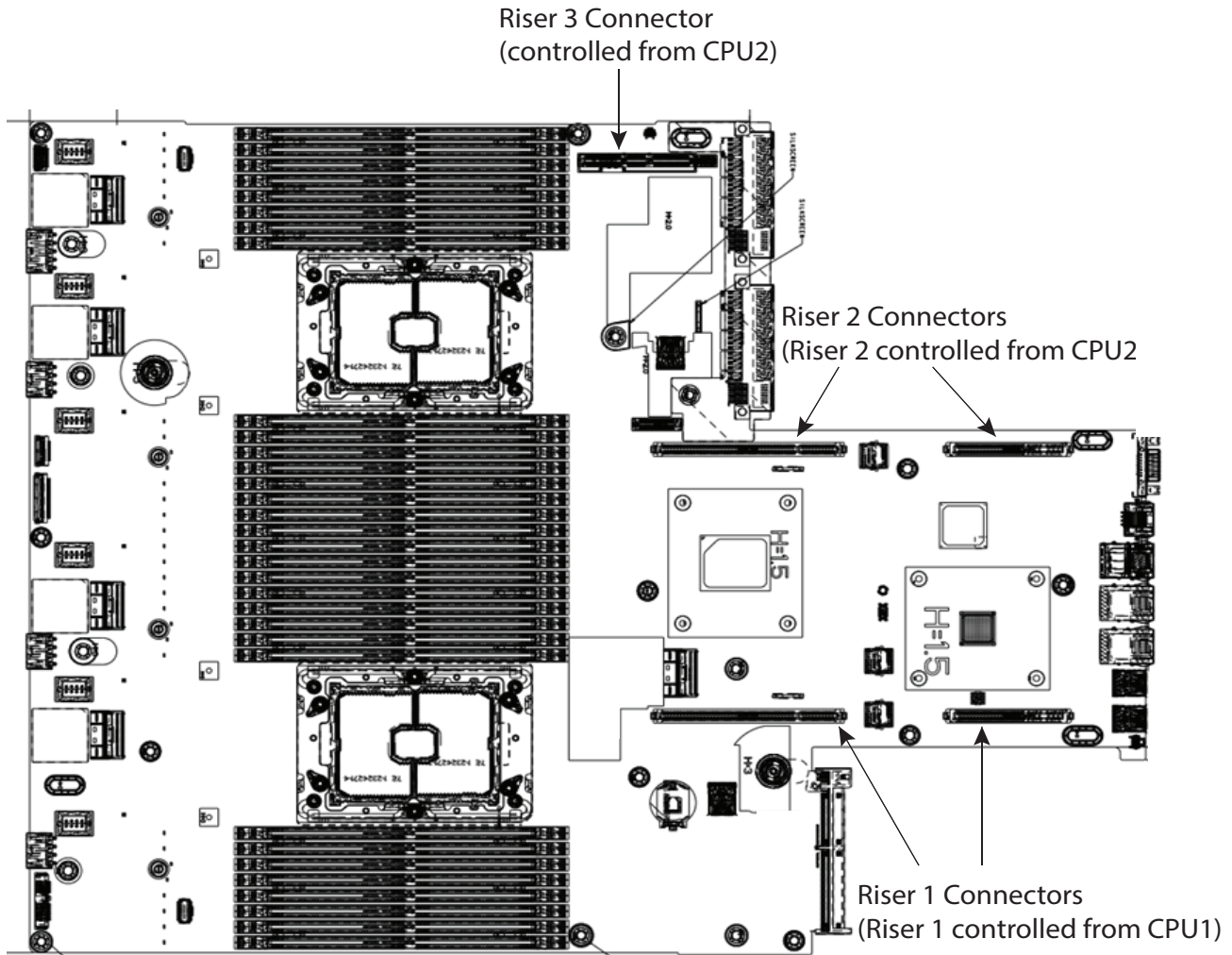
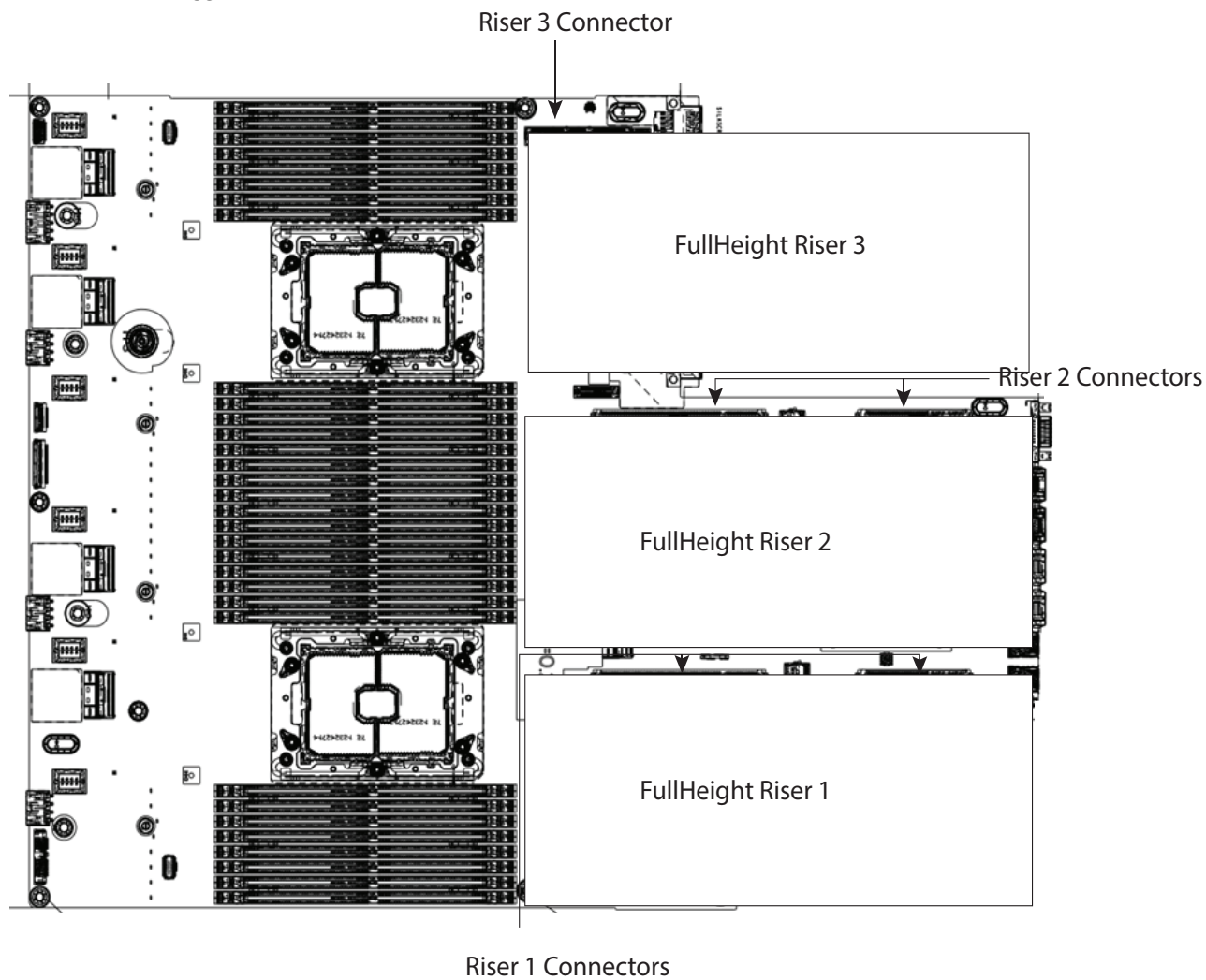

Figure 13 shows three full-height risers plugged into their respective connectors.

Figure 13 HyperFlex HX245C M6SX All Flash and Hybrid Server Nodes With Three Full-Height Risers Plugged In



Riser Card Configurations and Options

The riser card locations are shown in *Figure 14*.

Figure 14 Riser Card Locations

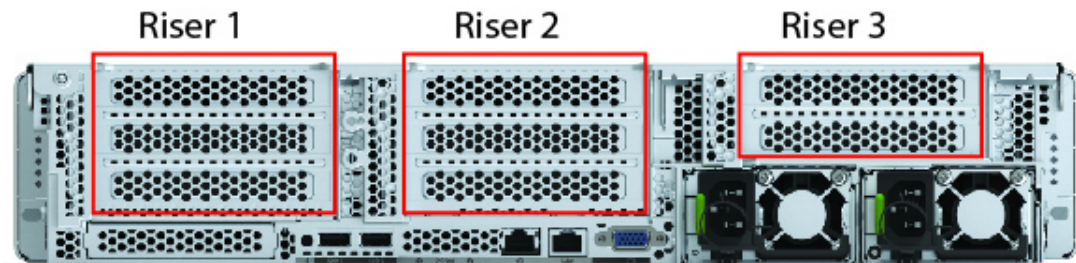

Riser 1A

Riser 1A mechanical information is shown in *Figure 15*.

Figure 15 Riser Card 1A

PCIe Riser 1A (outside)

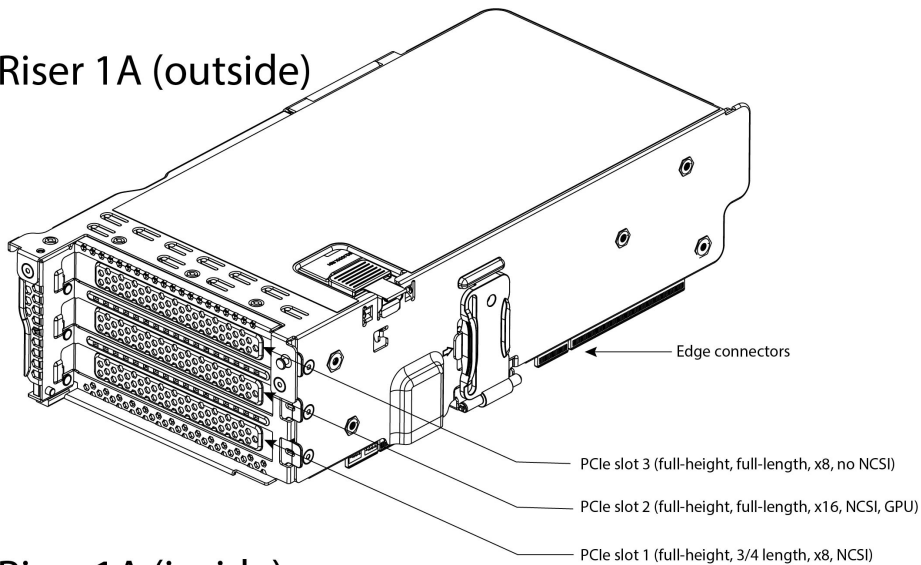

PCIe Riser 1A (inside)

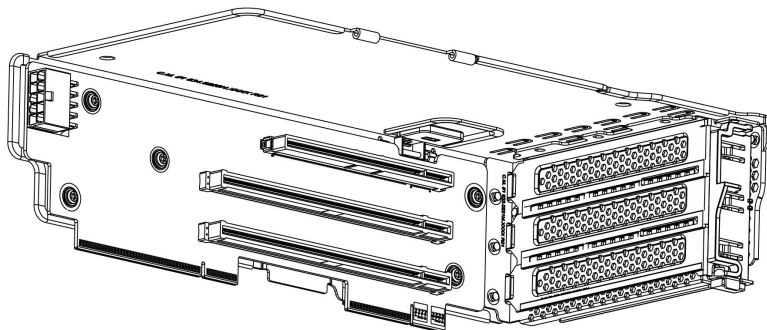

Riser 1B

Riser 1B mechanical information is shown in [Figure 16](#).

Figure 16 Riser Card 1B

PCIe Riser 1B (outside)

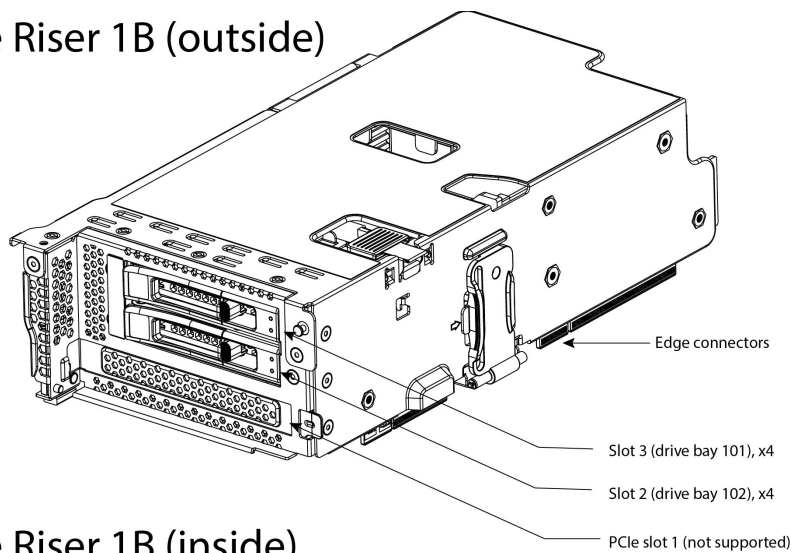

PCIe Riser 1B (inside)

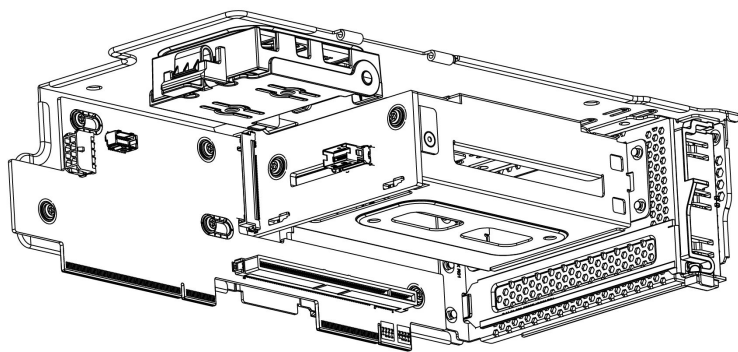

Riser 2A

Riser 2A mechanical information is shown in [Figure 17](#).

Figure 17 Riser Card 2A

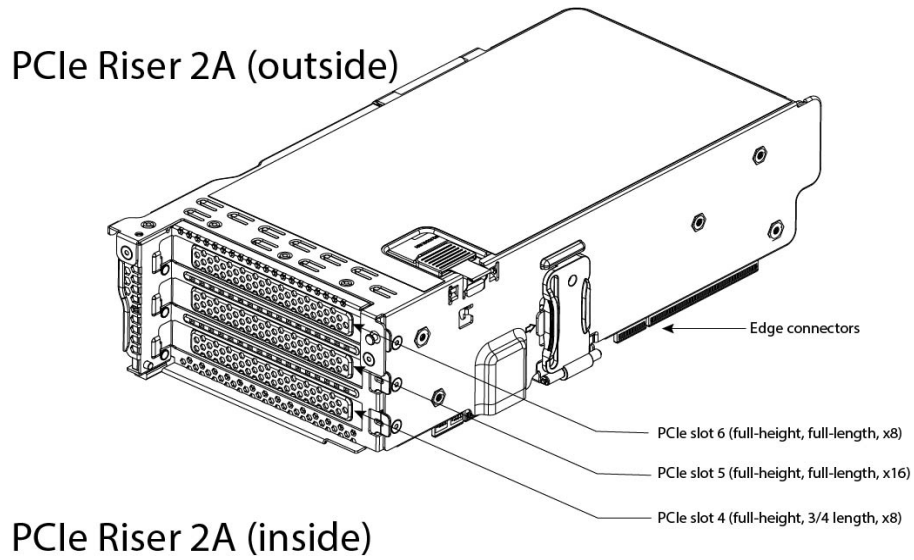

PCIe Riser 2A (inside)

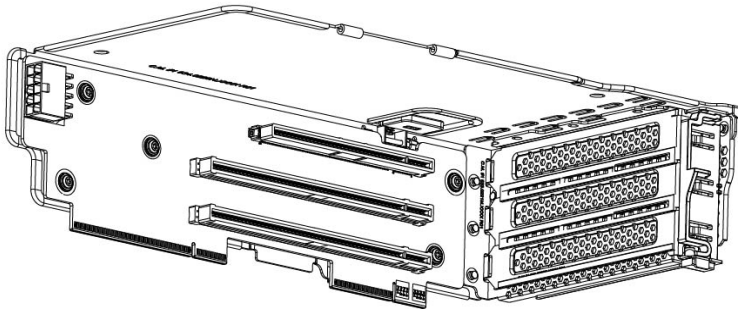

Riser 3A

Riser 3A mechanical information is shown in [Figure 18](#).

Figure 18 Riser Card 3A

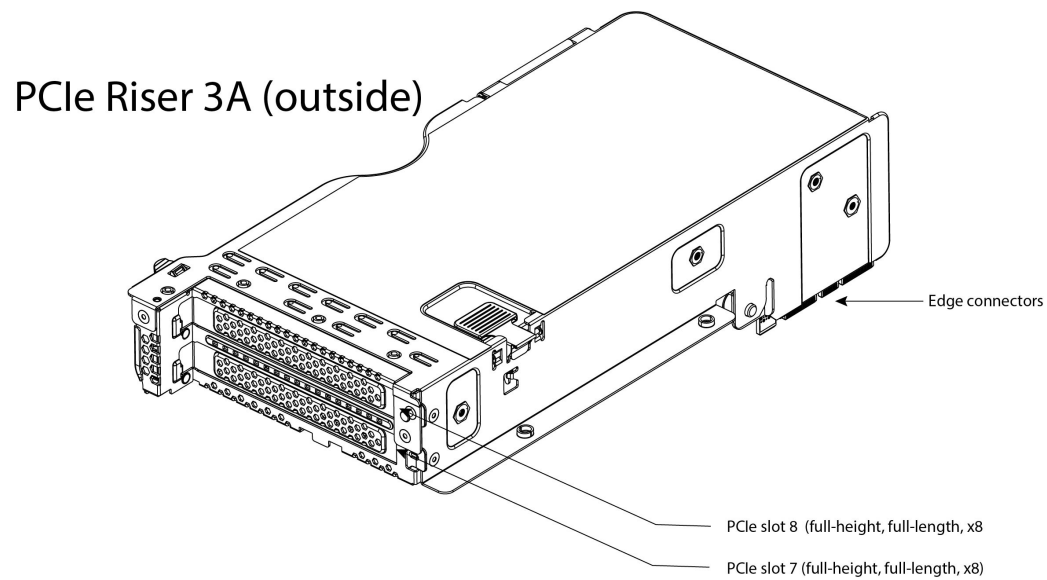

PCIe Riser 3A (inside)

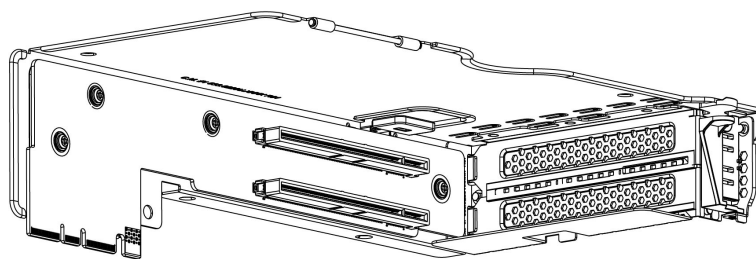

Riser 3B

Riser 3B mechanical information is shown in [Figure 19](#).

Figure 19 Riser Card 3B

PCIe Riser 3B (outside)

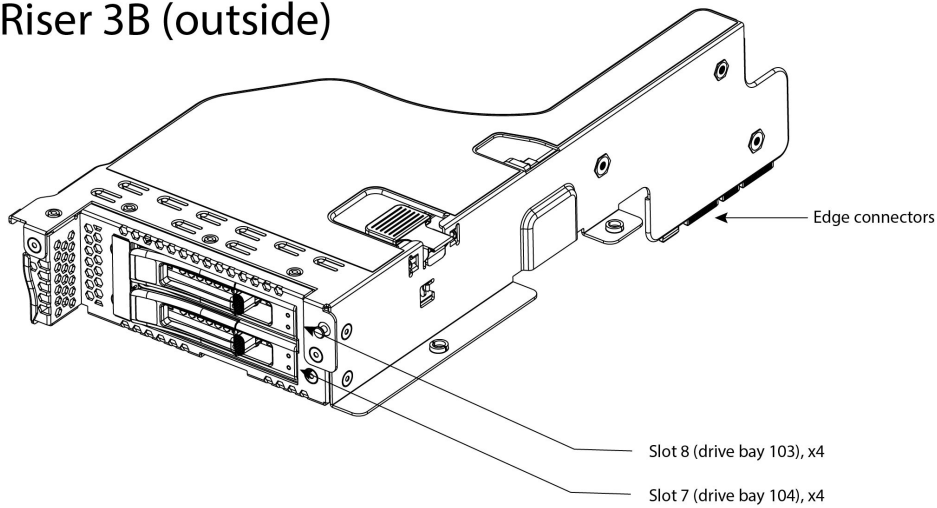

PCIe Riser 3B (inside)

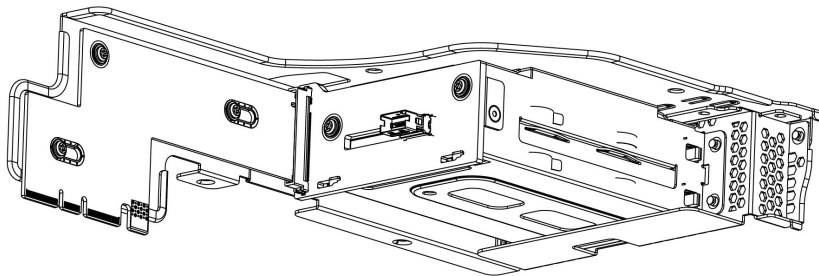

Riser 3C

Riser 3C mechanical information is shown in [Figure 20](#).

Figure 20 Riser Card 3C

PCIe Riser 3C (outside)

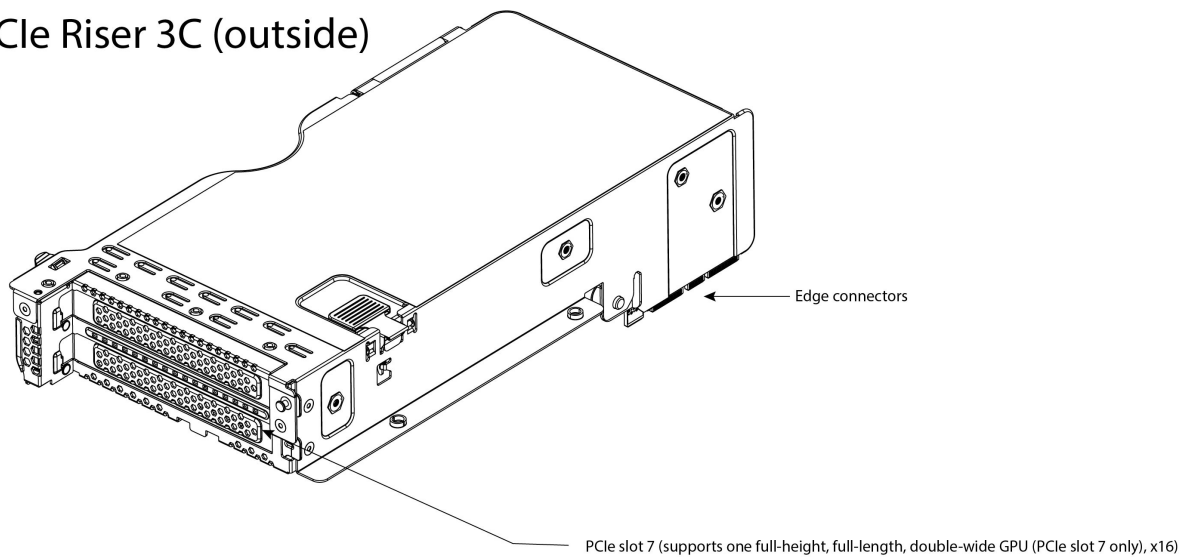

PCIe Riser 3C (inside)

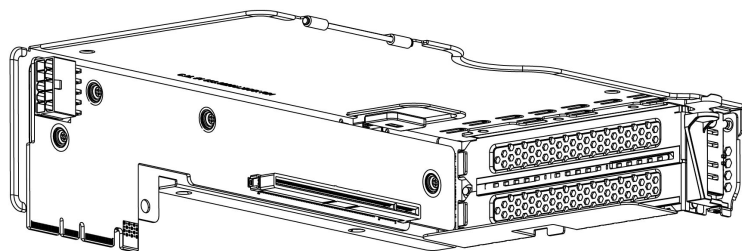

Memory Support for AMD Rome and Milan CPUs

Each CPU has 16 DIMM sockets and supports a maximum memory capacity of 4 TB using 16 x 256 GB DRAMs.

The CPUs support the DRAMs shown in [Table 42](#).

Table 42 Supported DRAMs

DRAM Type	Ranks	Capacity
RDIMM	1 (SR)	16 GB
RDIMM	2 (DR)	32 GB or 64 GB
LRDIMM	4 (QR)	128 GB (non-3DS)
LRDIMM	8 (8R)	256 GB (3DS)

Serial Port Details

The pinout details of the rear RJ-45 serial port connector are shown in [Figure 21](#).

Figure 21 Serial Port (Female RJ-45 Connector) Pinout

Serial Port (RJ-45 Female Connector)

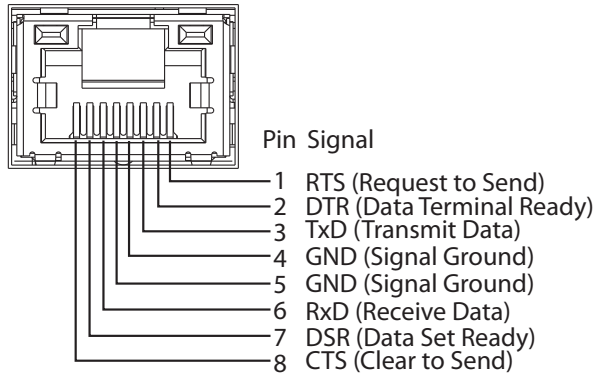

KVM Cable

The KVM cable provides a connection into the server, providing a DB9 serial connector, a VGA connector for a monitor, and dual USB 2.0 ports for a keyboard and mouse. With this cable, you can create a direct connection to the operating system and the BIOS running on the server.

The KVM cable ordering information is listed in [Table 43](#).

Table 43 KVM Cable

Product ID (PID)	PID Description
N20-BKVM	KVM cable for server console port

Figure 22 KVM Cable

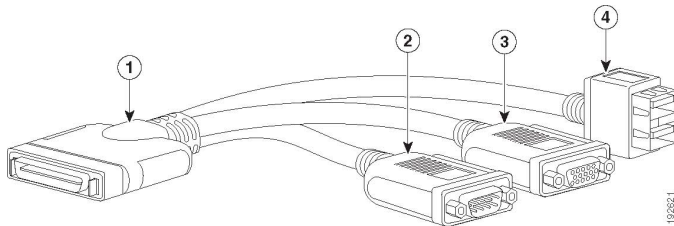

1	Connector (to server front panel)	3	VGA connector (for a monitor)
2	DB-9 serial connector	4	Two-port USB 2.0 connector (for a mouse and keyboard)

SPARE PARTS

This section lists the upgrade and service-related parts for the Cisco HyperFlex HX245C M6SX All Flash and Hybrid Server Nodes. Some of these parts are configured with every server.



NOTE: Some spare parts you order may also require accessories for full functionality. For example, drives or RAID controllers may need accompanying cables. CPUs may need heatsinks, thermal paste, and installation tools. The spares and their accessory parts are listed in [Table 44](#).

Table 44 Spare Parts

Product ID (PID)	PID Description
KVM Cable	
N20-BKVM=	KVM local IO cable for UCS servers console port
Risers	
HX-RIS1A-240M6=	C240 M6 Riser1A; (x8;x16x, x8); StBkt; (CPU1)
HX-RIS1B-240M6=	C240 M6 Riser1B; 2xHDD/SSD; StBkt; (CPU1)
UCSC-RIS2A-240M6=	C240 M6 Riser2A; (x8;x16;x8);StBkt; (CPU2)
HX-RIS3A-240M6=	C240 M6 Riser3A (x8;x8); StBkt; (CPU2)
HX-RIS3B-240M6=	C240 M6 Riser 3B; 2xHDD; StBkt; (CPU2)
HX-RIS3C-240M6=	C240 M6 Riser 3C
UCSC-FBRS2-C240M6=	C240M6 2U Riser2 Filler Blank
UCSC-FBRS3-C240M6=	C240M6 2U Riser3 Filler Blank
CPUs	
<p>Note: When ordering spare CPUs, check the CPU Accessories section of this table for additional parts you may need.</p>	
HX-CPU-A7773X=	AMD 2.20GHz 7773X 280W 64C/768MB Cache DDR4 3200MHz
HX-CPU-A7763=	AMD 2.5GHz 7763 280W 64C/256MB Cache DDR4 3200MHz
HX-CPU-A7713P=	AMD 2.0GHz 7713P 225W 64C/256MB Cache DDR4 3200MHz
HX-CPU-A7713=	AMD 2.0GHz 7713 225W 64C/256MB Cache DDR4 3200MHz
HX-CPU-A7663=	AMD 2.0GHz 7663 225W 56C/256MB Cache DDR4 3200MHz
HX-CPU-A7662=	AMD 2.0GHz 7662 225W 64C/256MB Cache DDR4 3200MHz
HX-CPU-A7643=	AMD 2.3GHz 7643 225W 48C/256MB Cache DDR4 3200MHz
HX-CPU-A75F3=	AMD 2.95GHz 75F3 280W 32C/256MB Cache DDR4 3200MHz
HX-CPU-A7573X=	AMD 2.80GHz 7573X 280W 32C/768MB Cache DDR4 3200MHz
HX-CPU-A7543P=	AMD 2.7GHz 7543P 225W 32C/256MB Cache DDR4 3200MHz
HX-CPU-A7543=	AMD 2.7GHz 7543 225W 32C/256MB Cache DDR4 3200MHz
HX-CPU-A7532=	AMD 2.4GHz 7532 200W 32C/256MB Cache DDR4 3200MHz
HX-CPU-A7513=	AMD 2.6GHz 7513 200W 32C/128MB Cache DDR4 3200MHz
HX-CPU-A7502P=	AMD 2.5GHz 7502P 180W 32C/128MB Cache DDR4 3200MHz

Table 44 Spare Parts (continued)



Product ID (PID)	PID Description
HX-CPU-A74F3=	AMD 3.2GHz 74F3 240W 24C/256MB Cache DDR4 3200MHz
HX-CPU-A7473X=	AMD 2.80GHz 7473X 240W 24C/768MB Cache DDR4 3200MHz
HX-CPU-A7453=	AMD 2.75GHz 7453 180W 28C/64MB Cache DDR4 3200MHz
HX-CPU-A7443P=	AMD 2.85GHz 7443P 200W 24C/128MB Cache DDR4 3200MHz
HX-CPU-A7443=	AMD 2.8GHz 7443 200W 24C/128MB Cache DDR4 3200MHz
HX-CPU-A7413=	AMD 2.6GHz 7413 180W 24C/128MB Cache DDR4 3200MHz
HX-CPU-A73F3=	AMD 3.5GHz 73F3 240W 16C/256MB Cache DDR4 3200MHz
HX-CPU-A7373X=	AMD 3.05GHz 7373X 240W 16C/768MB Cache DDR4 3200MHz
HX-CPU-A7352=	AMD 2.3GHz 7352 155W 24C/128MB Cache DDR4 3200MHz
HX-CPU-A7343=	AMD 3.2GHz 7343 190W 16C/128MB Cache DDR4 3200MHz
HX-CPU-A7313P=	AMD 3.0GHz 7313P 155W 16C/128MB Cache DDR4 3200MHz
HX-CPU-A7313=	AMD 2.9GHz 7313 155W 16C/128MB Cache DDR4 3200MHz
HX-CPU-A7302=	AMD 3.0GHz 7302 155W 16C/128MB Cache DDR4 3200MHz
HX-CPU-A72F3=	AMD 3.7GHz 72F3 180W 8C/256MB Cache DDR4 3200MHz
HX-CPU-A7282=	AMD 2.8GHz 7282 120W 16C/64MB Cache DDR4 3200MHz
HX-CPU-A7272=	AMD 2.9GHz 7272 120W 12C/64MB Cache DDR4 3200MHz
HX-CPU-A7262=	AMD 3.2GHz 7262 155W 8C/128MB Cache DDR4 3200MHz
HX-CPU-A7252=	AMD 3.1GHz 7252 120W 8C/64MB Cache DDR4 3200MHz
HX-CPU-A7232P=	AMD 3.1GHz 7232P 120W 8C/32MB Cache DDR4 3200MHz
CPU Accessories	
UCS-CPU-TIM=  Note: This part is included with the purchase of spare CPU.Can be ordered separately.	Single CPU thermal interface material syringe for M5 server HS seal ¹
UCS-M6-CPU-CAR=  Note: This part is included with the purchase of spare CPU.Can be ordered separately.	Spare CPU Carrier for M6
UCSX-HSCK=  Note: This part is included with the purchase of spare CPU.Can be ordered separately.	UCS CPU/Heatsink Cleaning Kit, for up to 4 CPU/heatsink sets

Table 44 Spare Parts (continued)



Product ID (PID)	PID Description
UCS-CPUAT=  Note: This part is included with the purchase of spare CPU.Can be ordered separately.	CPU Assembly Tool for Servers
UCSC-HSHP-240M6=  Note: Order this Heatsink, if you are adding additional CPU/spare CPU	Heatsink for 2U SFF M6 PCIe SKU
UCSC-FAN-C240M6=	C240M6 2U Fan
Memory	
HX-MR-X16G1RW=	16 GB RDIMM SRx4 3200 (8Gb)
HX-MR-X32G1RW=	32 GB RDIMM SRx4 3200 (16Gb)
HX-MR-X32G2RW=	32 GB RDIMM DRx4 3200 (8Gb)
HX-MR-X64G2RW=	64 GB RDIMM DRx4 3200 (16Gb)
HX-ML-128G4RW=	128 GB LRDIMM QRx4 3200 (16Gb)
HX-ML-256G8RW=	256 GB LRDIMM 8Rx4 3200 (16Gb)
UCS-DIMM-BLK=	UCS DIMM Blanking Panel - C480M5
Drives	
HXAF245C-M6SX (All flash)	
Front Capacity Drive	
HX-SD960G6S1X-EV=	960GB 2.5 inch Enterprise Value 6G SATA SSD
HX-SD19T6S1X-EV=	1.9TB 2.5 inch Enterprise Value 6G SATA SSD
HX-SD38T6S1X-EV=	3.8TB 2.5 inch Enterprise Value 6G SATA SSD
HX-SD76T6S1X-EV=	7.6TB 2.5 inch Enterprise Value 6G SATA SSD
Rear Capacity Drive	
HX-SD960G6S1X-EV=	960GB 2.5 inch Enterprise Value 6G SATA SSD
HX-SD19T6S1X-EV=	1.9TB 2.5 inch Enterprise Value 6G SATA SSD
HX-SD38T6S1X-EV=	3.8TB 2.5 inch Enterprise Value 6G SATA SSD
HX-SD76T6S1X-EV=	7.6TB 2.5 inch Enterprise Value 6G SATA SSD
Front Cache Drive	
HX-NVMEXPB-I375=	375GB 2.5in Intel Optane NVMe Extreme Performance SSD
HX-SD800GK3X-EP=	800GB 2.5in Enterprise Performance 12G SAS SSD(3X endurance)
Front System Drive	
HX-SD240GM1X-EV=	240GB 2.5 inch Enterprise Value 6G SATA SSD
Boot Drive	
HX-M2-240GB=	240GB SATA M.2

Table 44 Spare Parts (continued)



Product ID (PID)	PID Description
HX-M2-HWRAID=	Cisco Boot optimized M.2 Raid controller
HX245C-M6SX (Hybrid)	
Front Capacity Drive	
HX-HD12TB10K12N=	1.2 TB 12G SAS 10K RPM SFF HDD
HX-HD18TB10K4KN=	1.8TB 12G SAS 10K RPM SFF HDD (4K)
HX-HD24TB10K4KN=	2.4 TB 12G SAS 10K RPM SFF HDD (4K)
Rear Capacity Drive	
HX-HD12TB10K12N=	1.2 TB 12G SAS 10K RPM SFF HDD
HX-HD18TB10K4KN=	1.8TB 12G SAS 10K RPM SFF HDD (4K)
HX-HD24TB10K4KN=	2.4 TB 12G SAS 10K RPM SFF HDD (4K)
Front Cache Drive	
HX-SD16TK3X-EP=	1.6TB 2.5in Enterprise Performance 12G SAS SSD(3X endurance)
Front System Drive	
HX-SD240GM1X-EV=	240GB 2.5 inch Enterprise Value 6G SATA SSD
Boot Drive	
HX-M2-240GB=	240GB SATA M.2
HX-M2-HWRAID=	Cisco Boot optimized M.2 Raid controller
M.2 SATA SSDs	
HX-M2-240GB=	240 GB M.2 SATA SSD
Drive Blanking Panel	
HX-BBLKD-S2=	C-Series M5 SFF drive blanking panel
Drive Cables	
CBL-SDFNVME-C245M6=	C245M6 2U x4 Front NVMe cable
RAID Controllers/SAS HBAs	
 <p>Note: When ordering additional RAID controllers, you may need to order a cable/supercap to connect from the RAID controller to the motherboard. See the RAID Controller Accessories section in this table.</p>	
HX-SAS-240M6=	Cisco 12G SAS HBA
RAID Controller Accessories	
CBL-SDSAS-245M6=	CBL C245 M6SX (2U24) MB CPU1(NVMe-Drive)
 <p>Note: This cable set may be required, if you are adding UCSC-RAID-M6SD to HX-C245-M6SX</p>	

Table 44 Spare Parts (continued)



Product ID (PID)	PID Description
CBL-SAS24-245M6=  Note: This cable set may be required, if you are adding SAS Drive and HX-SAS-240M6 (quantity 2)	C245M6 SAS cable 24 (2U); Pismo Rock
PCIe Cards	
Virtual Interface Card (VICs)	
HX-PCIE-C100-04=	Cisco UCS VIC 1495 Dual Port 40/100G QSFP28 CNA PCIe
HX-PCIE-C25Q-04=	Cisco UCS VIC 1455 quad port 10/25G SFP28 PCIe
Network Interface Cards (NICs)	
1 Gb NICs	
HX-PCIE-IRJ45=	Intel i350 quad-port 1G copper PCIe
10 Gb NICs	
HX-PCIE-ID10GF=	Intel X710-DA2 Dual Port 10Gb SFP+ NIC
HX-P-ID10GC=	Cisco-Intel X710T2LG 2x10 GbE RJ45 PCIe NIC
HX-PCIE-IQ10GF=	Intel X710 quad-port 10G SFP+ NIC
25 Gb NICs	
HX-P-I8D25GF=	Cisco-Intel E810XXVDA2 2x25/10 GbE SFP28 PCIe NIC
HX-P-I8Q25GF=	Cisco-Intel E810XXVDA4L 4x25/10 GbE SFP28 PCIe NIC
GPU PCIe Cards	
 Note: If you are adding a GPU, you may need to add cables and other accessories for the GPU. See the GPU accessories and NVIDIA GPU Licenses section of this table.	
HX-GPU-A10=	TESLA A10, PASSIVE, 150W, 24GB
HX-GPU-A30=	Tesla A30
HX-GPU-A40=	TESLA A40 RTX, PASSIVE, 300W, 48GB
HX-GPU-A100-80 ⁵ =	TESLA A100, PASSIVE, 300W, 80GB
HX-GPU-A16=	NVIDIA A16 PCIe 250W 4X16GB
GPU accessories	
UCS-M10CBL-C240M5  Note: Order this cable if you are adding an A10/M10 GPU	C240M5 NVIDIA M10/A10 Cable

Table 44 Spare Parts (continued)





Product ID (PID)	PID Description
UCS-P100CBL-240M5  Note: Order this cable if you are adding an A100 /A40/ A16/A30 GPU	C240M5 NVIDIA P100 /RTX /A100 /A40/ A16 /A30 Cable
CBL-GPU-C240M6  Note: Order this power cable if you are adding an A10 GPU	Y TYPE GPU POWER Cable for A10 GPU, C240M6 and C245M6
UCSC-HSLP-M6=  Note: Order this Heatsink if you are adding an GPUs	Heatsink for 1U/2U LFF/SFF GPU SKU
HX-ADGPU-245M6  Note: You may need to order this Air Duct if you are adding an GPUs	C245M6 GPU Air Duct 2USFF/NVMe (for DW/FL only)
NVIDIA GPU Licenses  Note: Order the GPU licenses if are adding the NVDIA GPUs	
<ul style="list-style-type: none"> • If you already have a NVDIA GPU and adding another one, or if you are replacing NVDIA GPUs, then existing license should be fine. • if you don't have a GPU already installed, and you are adding the first one or two, you may need to order the license. 	
NV-VCS-1YR=	NVIDIA vCompute Server Subscription - 1 GPU - 1 Year
NV-VCS-3YR=	NVIDIA vCompute Server Subscription - 1 GPU - 3 Year
NV-VCS-5YR=	NVIDIA vCompute Server Subscription - 1 GPU - 5 Year
NV-VCS-R-1Y=	Renew NVIDIA vCompute Server Subscription - 1 GPU - 1 Year
NV-VCS-R-3Y=	Renew NVIDIA vCompute Server Subscription - 1 GPU - 3 Year
NV-VCS-R-5Y=	Renew NVIDIA vCompute Server Subscription - 1 GPU - 5 Year
NV-GRDWK-1-5S=	Quadro Perpetual Lic - NVIDIA vDWS 1CCU; 5Yr SUMS Req
NV-GRDVA-1-5S=	GRID Perpetual Lic - NVIDIA VDI APPS 1CCU; 5Yr SUMS Reqd
NV-GRDPC-1-5S=	GRID Perpetual Lic - NVIDIA VDI PC 1CCU; 5Yr SUMS Reqd
NV-GRD-EDP-5S=	EDU - Quadro Perpetual Lic - NVIDIA vDWS 1CCU; 5Yr SUMS Reqd
NV-GRID-WKP-5YR=	NVIDIA Quadro Production SUMS - vDWS 1CCU - 5 Year
NV-GRID-VAP-5YR=	NVIDIA GRID Production SUMS - VDI Apps 1CCU - 5 Year

Table 44 Spare Parts (continued)

Product ID (PID)	PID Description
NV-GRID-PCP-5YR=	NVIDIA GRID Production SUMS - VDI PC 1CCU - 5 Year
NV-GRID-EDP-5YR=	EDU - NVIDIA Quadro vDWS Production SUMS - 1CCU - 5 Year
NV-GRID-WKS-1YR=	NVIDIA Quadro SW Subscription - vDWS 1CCU - 1 Year
NV-GRID-WKS-3YR=	NVIDIA Quadro SW Subscription - vDWS 1CCU - 3 Year
NV-GRID-WKS-4YR=	NVIDIA Quadro SW Subscription - vDWS 1CCU - 4 Year
NV-GRID-WKS-5YR=	NVIDIA Quadro SW Subscription - vDWS 1CCU - 5 Year
NV-GRID-PCS-1YR=	NVIDIA GRID Software Subscription - VDI PC 1CCU - 1 Year
NV-GRID-PCS-3YR=	NVIDIA GRID Software Subscription - VDI PC 1CCU - 3 Year
NV-GRID-PCS-4YR=	NVIDIA GRID Software Subscription - VDI PC 1CCU - 4 Year
NV-GRID-PCS-5YR=	NVIDIA GRID Software Subscription - VDI PC 1CCU - 5 Year
NV-GRID-VAS-1YR=	NVIDIA GRID Software Subscription - VDI Apps 1CCU - 1 Year
NV-GRID-VAS-3YR=	NVIDIA GRID Software Subscription - VDI Apps 1CCU - 3 Year
NV-GRID-VAS-4YR=	NVIDIA GRID Software Subscription - VDI Apps 1CCU - 4 Year
NV-GRID-VAS-5YR=	NVIDIA GRID Software Subscription - VDI Apps 1CCU - 5 Year
NV-GRID-EDS-1YR=	EDU - NVIDIA Quadro vDWS SW Subscription - 1CCU - 1 Year
NV-GRID-EDS-3YR=	EDU - NVIDIA Quadro vDWS SW Subscription - 1CCU - 3 Year
NV-GRID-EDS-4YR=	EDU - NVIDIA Quadro vDWS SW Subscription - 1CCU - 4 Year
NV-GRID-EDS-5YR=	EDU - NVIDIA Quadro vDWS SW Subscription - 1CCU - 5 Year
NV-GRID-VAP-R-4Y=	Renew NVIDIA GRID vApps SUMS 1CCU 4 Year
NV-GRID-PCP-R-4Y=	Renew NVIDIA GRID vPC SUMS 1CCU 4 Year
NV-QUAD-WKP-R-4Y=	Renew NVIDIA Quadro vDWS SUMS 1CCU 4 Year
NV-QUAD-WKPE-R-4Y=	Renew NVIDIA Quadro vDWS SUMS 1CCU EDU 4 Year
NV-QUAD-WKS-R-1Y=	Renew NVIDIA Quadro vDWS Subscr 1CCU 1 Year
NV-QUAD-WKS-R-3Y=	Renew NVIDIA Quadro vDWS Subscr 1CCU 3 Year
NV-QUAD-WKS-R-4Y=	Renew NVIDIA Quadro vDWS Subscr 1CCU 4 Year
NV-QUAD-WKS-R-5Y=	Renew NVIDIA Quadro vDWS Subscr 1CCU 5 Year
NV-QUAD-WKSE-R-1Y=	Renew NVIDIA Quadro vDWS Subscr 1CCU EDU 1 Year
NV-QUAD-WKSE-R-3Y=	Renew NVIDIA Quadro vDWS Subscr 1CCU EDU 3 Year
NV-QUAD-WKSE-R-4Y=	Renew NVIDIA Quadro vDWS Subscr 1CCU EDU 4 Year
NV-GRID-VAS-R-1Y=	Renew NVIDIA GRID vApps Subscr 1CCU 1 Year
NV-GRID-VAS-R-3Y=	Renew NVIDIA GRID vApps Subscr 1CCU 3 Year
NV-GRID-VAS-R-4Y=	Renew NVIDIA GRID vApps Subscr 1CCU 4 Year
NV-GRID-VAS-R-5Y=	Renew NVIDIA GRID vApps Subscr 1CCU 5 Year
NV-GRID-PCS-R-1Y=	Renew NVIDIA GRID vPC Subscr 1CCU 1 Year
NV-GRID-PCS-R-3Y=	Renew NVIDIA GRID vPC Subscr 1CCU 3 Year
NV-GRID-PCS-R-4Y=	Renew NVIDIA GRID vPC Subscr 1CCU 4 Year
NV-GRID-PCS-R-5Y=	Renew NVIDIA GRID vPC Subscr 1CCU 5 Year
NV-QUAD-WKP-R-1Y=	Renew NVIDIA Quadro vDWS SUMS 1CCU 1 Year
NV-QUAD-WKP-R-3Y=	Renew NVIDIA Quadro vDWS SUMS 1CCU 3 Year

Table 44 Spare Parts (continued)

Product ID (PID)	PID Description
NV-QUAD-WKP-R-5Y=	Renew NVIDIA Quadro vDWS SUMS 1CCU 5 Year
NV-QUAD-WKPE-R-1Y=	Renew NVIDIA Quadro vDWS SUMS 1CCU EDU 1 Year
NV-QUAD-WKPE-R-3Y=	Renew NVIDIA Quadro vDWS SUMS 1CCU EDU 3 Year
NV-QUAD-WKPE-R-5Y=	Renew NVIDIA Quadro vDWS SUMS 1CCU EDU 5 Year
NV-GRID-VAP-R-1Y=	Renew NVIDIA GRID vApps SUMS 1CCU 1 Year
NV-GRID-VAP-R-3Y=	Renew NVIDIA GRID vApps SUMS 1CCU 3 Year
NV-GRID-VAP-R-5Y=	Renew NVIDIA GRID vApps SUMS 1CCU 5 Year
NV-GRID-PCP-R-1Y=	Renew NVIDIA GRID vPC SUMS 1CCU 1 Year
NV-GRID-PCP-R-3Y=	Renew NVIDIA GRID vPC SUMS 1CCU 3 Year
NV-GRID-PCP-R-5Y=	Renew NVIDIA GRID vPC SUMS 1CCU 5 Year
NV-GRD-VA2WKP-5S=	Upgrade NVIDIA VDI APPS to Quadro vDWS 1CCU; 5Yr SUMS Reqd
NV-GRD-VA2PCP-5S=	Upgrade NVIDIA VDI APPS to vPC 1CCU; 5Yr SUMS Reqd
NV-GRD-VA2WKPE-5S=	Upgrade NVIDIA VDI to Quadro vDWS 1CCU; 5Yr SUMS Reqd
NV-GRD-PC2WKP-5S=	Upgrade NVIDIA vPC to Quadro vDWS 1CCU; 5Yr SUMS Reqd
NV-GRD-PC2WKPE-5S=	Upgrade NVIDIA vPC to Quadro vDWS 1CCU; 5Yr SUMS Reqd
Power Supplies	
HX-PSU1-1050W=	UCS 1050W AC PSU Platinum (Not EU/UK Lot 9 Compliant)
HX-PSUV2-1050DC=	Cisco UCS 1050W -48V DC Power Supply for Rack Server Requires power cord CAB-48DC-40A-8AWG
HX-PSU1-1200W=	1200W Titanium power supply for C-Series Servers
HX-PSU1-1600W=	UCS 1600W AC PSU Platinum (Not EU/UK Lot 9 Compliant)
HX-PSU1-2300W ² =	2300W Power supply for Rack servers Titanium
PSU (Input Low Line 110VAC)	
HX-PSU1-1050W=	UCS 1050W AC PSU Platinum (Not EU/UK Lot 9 Compliant)
HX-PSUV2-1050DC=	Cisco UCS 1050W -48V DC Power Supply for Rack Server Requires power cord CAB-48DC-40A-8AWG
HX-PSU1-2300W=	2300W Power supply for Rack servers Titanium
HX-PSU1-1200W=	1200W Titanium power supply for C-Series Servers
Power Supply Blanking Panel	
UCS-PSU-M5BLK=	Power Supply Blanking Panel for M5 servers
Power Cables	
CAB-48DC-40A-8AWG=	C-Series -48VDC PSU Power Cord, 3.5M, 3 Wire, 8AWG, 40A
CAB-N5K6A-NA=	Power Cord, 200/240V 6A, North America
CAB-AC-L620-C13=	AC Power Cord, NEMA L6-20 - C13, 2M/6.5ft
CAB-C13-CBN=	CABASY,WIRE,JUMPER CORD, 27" L, C13/C14, 10A/250V
CAB-C13-C14-2M=	CABASY,WIRE,JUMPER CORD, PWR, 2 Meter, C13/C14,10A/250V
CAB-C13-C14-AC=	CORD,PWR,JMP,IEC60320/C14,IEC6 0320/C13, 3.0M
CAB-250V-10A-AR=	Power Cord, 250V, 10A, Argentina
CAB-9K10A-AU=	Power Cord, 250VAC 10A 3112 Plug, Australia
CAB-250V-10A-CN=	AC Power Cord - 250V, 10A - PRC

Table 44 Spare Parts (continued)

Product ID (PID)	PID Description
CAB-9K10A-EU=	Power Cord, 250VAC 10A CEE 7/7 Plug, EU
CAB-250V-10A-ID=	Power Cord, 250V, 10A, India
CAB-C13-C14-3M-IN=	Power Cord Jumper, C13-C14 Connectors, 3 Meter Length, India
CAB-C13-C14-IN=	Power Cord Jumper, C13-C14 Connectors, 1.4 Meter Length, India
CAB-250V-10A-IS=	Power Cord, SFS, 250V, 10A, Israel
CAB-9K10A-IT=	Power Cord, 250VAC 10A CEI 23-16/VII Plug, Italy
CAB-9K10A-SW=	Power Cord, 250VAC 10A MP232 Plug, Switzerland
CAB-9K10A-UK=	Power Cord, 250VAC 10A BS1363 Plug (13 A fuse), UK
CAB-9K12A-NA ³ =	Power Cord, 125VAC 13A NEMA 5-15 Plug, North America
CAB-250V-10A-BR=	Power Cord - 250V, 10A - Brazil
CAB-C13-C14-2M-JP=	Power Cord C13-C14, 2M/6.5ft Japan PSE mark
CAB-9K10A-KOR ¹ =	Power Cord, 125VAC 13A KSC8305 Plug, Korea
CAB-JPN-3PIN=	Japan, 90-125VAC 12A NEMA 5-15 Plug, 2.4m
CAB-48DC-40A-INT=	C-Series -48VDC PSU PWR Cord, 3.5M, 3 Wire, 8AWG, 40A (INT)
CAB-48DC-40A-AS=	C-Series -48VDC PSU PWR Cord, 3.5M, 3Wire, 8AWG, 40A (AS/NZ)
CAB-C19-CBN=	Cabinet Jumper Power Cord, 250 VAC 16A, C20-C19 Connectors
CAB-S132-C19-ISRL=	S132 to IEC-C19 14ft Israeli
CAB-IR2073-C19-AR=	IRSM 2073 to IEC-C19 14ft Argen
CAB-BS1363-C19-UK=	BS-1363 to IEC-C19 14ft UK
CAB-SABS-C19-IND=	SABS 164-1 to IEC-C19 India
CAB-C2316-C19-IT=	CEI 23-16 to IEC-C19 14ft Italy
CAB-US515P-C19-US=	NEMA 5-15 to IEC-C19 13ft US
CAB-US520-C19-US=	NEMA 5-20 to IEC-C19 14ft US
CAB-US620P-C19-US=	NEMA 6-20 to IEC-C19 13ft US
Rail Kit and CMA	
HX-RAIL-M6=	Ball Bearing Rail Kit for C220 & C240 M6 rack servers
HX-CMA-C220M6=	Reversible CMA for C220 M6 ball bearing rail kit
HX-RAIL-NONE=	NO RAIL KIT OPTION
TPM	
UCSX-TPM2-002B-C=	Trusted Platform Module 2.0 for UCS servers
HX-INT-SW02=	Chassis Intrusion Switch
Bezel	
HXAF240C-BZL-M5SX=	HXAF240C M5 Security Bezel
HX240C-BZL-M5S=	HX240C M5 Security Bezel

Notes:

1. This part is included with the purchase of option or spare CPU or CPU processor kits.
2. The 2300 W power supply uses a different power connector than the rest of the power supplies, so you must use different power cables to connect it. See [Table 21 on page 46](#) and [Table 22 on page 49](#).
3. This power cord is rated to 125V and only supported for PSU rated at 1050W or less

Please refer to “Cisco HyperFlex HX245C M6SX All Flash and Hybrid Server Nodes Installation and Service Guide” for installation procedures. See this link:

https://www.cisco.com/content/en/us/td/docs/unified_computing/ucs/c/hw/c245m6/install/c245m6.html

REPLACING CPUs and HEATSINKS



NOTE: Before servicing any CPU, do the following:

- Decommission and power off the server.
- Slide the Cisco HyperFlex HX245C M6SX All Flash and Hybrid Server Nodes out from the rack.
- Remove the top cover.



CAUTION:

- CPUs and their sockets are fragile and must be handled with extreme care to avoid damaging pins. The CPUs must be installed with heatsinks and thermal interface material to ensure cooling. Failure to install a CPU correctly might result in damage to the server.
- Always shut down the server before removing it from the chassis, as described in the procedures. Failure to shut down the server before removal results in the corresponding RAID supercap cache being discarded and other data might be lost.

To replace an existing CPU, follow these steps:

(1) Have the following tools and materials available for the procedure:

- T-20 Torx driver—Supplied with replacement CPU.
- Thermal interface material (TIM)—Syringe supplied with replacement CPU.

(2) Order the appropriate replacement CPU from [Table 6 on page 22](#)

(3) Carefully remove and replace the CPU and heatsink in accordance with the instructions found in “Cisco HyperFlex HX245C M6SX All Flash and Hybrid Server Nodes Installation and Service Guide,” found at:

https://www.cisco.com/content/en/us/td/docs/unified_computing/ucs/c/hw/c245m6/install/c245m6.html

To add a new CPU, follow these steps:

(1) Have the following tools and materials available for the procedure:

- T-30 Torx driver—Supplied with new CPU.
- Thermal interface material (TIM)—Syringe supplied with replacement CPU.

(2) Order the appropriate new CPU from [Table 6 on page 22](#)

(3) Order one heat sink for each new CPU. Order PID HX-HSHP-245M6 unless you have installed a double-wide or A10 GPU. In that case, order PID HX-HSLP-245M6.

(4) Carefully install the CPU and heatsink in accordance with the instructions found in “[Cisco UCS C240 M6 Server Installation and Service Guide](#).”

UPGRADING or REPLACING MEMORY



NOTE: Before servicing any DIMM, do the following:

- Decommission and power off the server.
- Remove the top cover from the server
- Slide the server out the front of the chassis.

To add or replace DIMMs, follow these steps:

Step 1 Open both DIMM connector latches.

Step 2 Press evenly on both ends of the DIMM until it clicks into place in its slot

Note: Ensure that the notch in the DIMM aligns with the slot. If the notch is misaligned, it is possible to damage the DIMM, the slot, or both.

Step 3 Press the DIMM connector latches inward slightly to seat them fully.

Step 4 Populate all slots with a DIMM or DIMM blank. A slot cannot be empty.

Figure 23 Replacing Memory

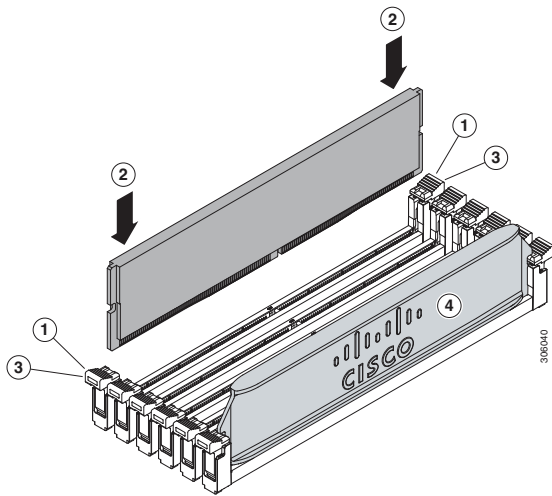

For additional details on replacing or upgrading DIMMs, see “Cisco UCS C240 M6 Server Installation and Service Guide,” found at these links:

https://www.cisco.com/content/en/us/td/docs/unified_computing/ucs/c/hw/c245m6/install/c245m6.html

TECHNICAL SPECIFICATIONS

Dimensions and Weight

Table 45 HyperFlex HX245C M6SX All Flash and Hybrid Server Nodes Dimensions and Weight

Parameter	Value
Height	3.42 in. (8.7 cm)
Width (Not including slam latches)	16.9 in. (42.9 cm)
Width (including slam latches)	18.9 in. (48.0 cm)
Depth	30 in. (76.2 cm)
Front Clearance	3 in. (76 mm)
Side Clearance	1 in. (25 mm)
Rear Clearance	6 in. (152 mm)
Weight	
Weight with following options and no rail kit: 0 HDD, 0 CPU, 0 DIMM, and 1 2400 W power supply	35.7 lbs (16.2 kg)
Weight with following options and including rail kit: 0 HDD, 0 CPU, 0 DIMM, and 1 2400 W power supply	44 lbs (20 kg)
Weight with following options and no rail kit: 1 HDD, 1 CPU, 1 DIMM, and 1 2400 W power supply	37.6 lbs (17 kg)
Weight with following options and including rail kit: 1 HDD, 1 CPU, 1 DIMM, and 1 2400 W power supply	45.9 lbs (20.8 kg)
Weight with following options and no rail kit: 8 HDDs, 2 CPUs, 32 DIMMs, and 2 2400 W power supplies	44.71 lbs (20.28 kg)
Weight with following options and including rail kit: 8 HDDs, 2 CPUs, 32 DIMMs, and 2 2400 W power supplies	49.2 lbs (22.32 kg)
Weight with following options and no rail kit: 0 HDD, 0 CPU, 0 DIMM, and 1 2400 W power supply	33.14 lbs (15 kg)
Weight with following options and including rail kit: 0 HDD, 0 CPU, 0 DIMM, and 1 2400 W power supply	41.45 lbs (18.8 kg)
Weight with following options and no rail kit: 1 HDD, 1 CPU, 1 DIMM, and 1 2400 W power supply	40.55 lbs (18.4kg)
Weight with following options and including rail kit: 1 HDD, 1 CPU, 1 DIMM, and 1 2400 W power supply	48.86 lbs (22.2 kg)
Weight with following options and no rail kit: 24 HDDs, 2 CPUs, 32 DIMMs, and 2 2400 W power supplies	58.8 lbs (26.7 kg)

Table 45 HyperFlex HX245C M6SX All Flash and Hybrid Server Nodes Dimensions and Weight

Parameter	Value
Weight with following options and including rail kit: 24 HDDs, 2 CPUs, 32 DIMMs, and 2 2400 W power supplies	61.7 lbs (28 kg)

Power Specifications

The server is available with the following types of power supplies:

- 1050 W (AC) power supply (see [Table 46](#)).
- 1050 W V2 (DC) power supply (see [Table 47](#))
- 1600 W (AC) power supply (see [Table 48](#))
- 2300 W (AC) power supply (see [Table 49](#))

Table 46 HyperFlex HX245C M6SX All Flash and Hybrid Server Nodes Power Specifications (1050 W AC power supply)

Parameter	Specification			
Input Connector	IEC320 C14			
Input Voltage Range (V rms)	100 to 240			
Maximum Allowable Input Voltage Range (V rms)	90 to 264			
Frequency Range (Hz)	50 to 60			
Maximum Allowable Frequency Range (Hz)	47 to 63			
Maximum Rated Output (W) ¹	800		1050	
Maximum Rated Standby Output (W)	36			
Nominal Input Voltage (V rms)	100	120	208	230
Nominal Input Current (A rms)	9.2	7.6	5.8	5.2
Maximum Input at Nominal Input Voltage (W)	889	889	1167	1154
Maximum Input at Nominal Input Voltage (VA)	916	916	1203	1190
Minimum Rated Efficiency (%) ²	90	90	90	91
Minimum Rated Power Factor ²	0.97	0.97	0.97	0.97
Maximum Inrush Current (A peak)	15			
Maximum Inrush Current (ms)	0.2			
Minimum Ride-Through Time (ms) ³	12			

Notes:

1. Maximum rated output is limited to 800W when operating at low-line input voltage (100-127V)
2. This is the minimum rating required to achieve 80 PLUS Platinum certification, see test reports published at <http://www.80plus.org/> for certified values
3. Time output voltage remains within regulation limits at 100% load, during input voltage dropout

Table 47 HyperFlex HX245C M6SX All Flash and Hybrid Server Nodes Power Specifications (1050 W V2 DC power supply)

Parameter	Specification
Input Connector	Molex 42820
Input Voltage Range (V rms)	-48
Maximum Allowable Input Voltage Range (V rms)	-40 to -72
Frequency Range (Hz)	NA
Maximum Allowable Frequency Range (Hz)	NA
Maximum Rated Output (W)	1050
Maximum Rated Standby Output (W)	36
Nominal Input Voltage (V rms)	-48
Nominal Input Current (A rms)	24
Maximum Input at Nominal Input Voltage (W)	1154
Maximum Input at Nominal Input Voltage (VA)	1154
Minimum Rated Efficiency (%) ¹	91
Minimum Rated Power Factor ¹	NA
Maximum Inrush Current (A peak)	15
Maximum Inrush Current (ms)	0.2
Minimum Ride-Through Time (ms) ²	5

Notes:

1. This is the minimum rating required to achieve 80 PLUS Platinum certification, see test reports published at <http://www.80plus.org/> for certified values
2. Time output voltage remains within regulation limits at 100% load, during input voltage dropout

Table 48 HyperFlex HX245C M6SX All Flash and Hybrid Server Nodes 1600 W (AC) Power Supply Specifications

Parameter	Specification			
Input Connector	IEC320 C14			
Input Voltage Range (V rms)	200 to 240			
Maximum Allowable Input Voltage Range (V rms)	180 to 264			
Frequency Range (Hz)	50 to 60			
Maximum Allowable Frequency Range (Hz)	47 to 63			
Maximum Rated Output (W) ¹	1600			
Maximum Rated Standby Output (W)	36			
Nominal Input Voltage (V rms)	100	120	208	230
Nominal Input Current (A rms)	NA	NA	8.8	7.9
Maximum Input at Nominal Input Voltage (W)	NA	NA	1778	1758
Maximum Input at Nominal Input Voltage (VA)	NA	NA	1833	1813
Minimum Rated Efficiency (%) ²	NA	NA	90	91
Minimum Rated Power Factor ²	NA	NA	0.97	0.97
Maximum Inrush Current (A peak)	30			
Maximum Inrush Current (ms)	0.2			
Minimum Ride-Through Time (ms) ³	12			

Notes:

1. Maximum rated output is limited to 800W when operating at low-line input voltage (100-127V)
2. This is the minimum rating required to achieve 80 PLUS Platinum certification, see test reports published at <http://www.80plus.org/> for certified values
3. Time output voltage remains within regulation limits at 100% load, during input voltage dropout

Table 49 HyperFlex HX245C M6SX All Flash and Hybrid Server Nodes 2300 W (AC) Power Supply Specifications

Parameter	Specification			
Input Connector	IEC320 C20			
Input Voltage Range (Vrms)	100 to 240			
Maximum Allowable Input Voltage Range (Vrms)	90 to 264			
Frequency Range (Hz)	50 to 60			
Maximum Allowable Frequency Range (Hz)	47 to 63			
Maximum Rated Output (W) ¹	2300			
Maximum Rated Standby Output (W)	36			
Nominal Input Voltage (Vrms)	100	120	208	230
Nominal Input Current (Arms)	13	11	12	10.8
Maximum Input at Nominal Input Voltage (W)	1338	1330	2490	2480
Maximum Input at Nominal Input Voltage (VA)	1351	1343	2515	2505
Minimum Rated Efficiency (%) ²	92	92	93	93
Minimum Rated Power Factor ²	0.99	0.99	0.97	0.97
Maximum Inrush Current (A peak)	30			
Maximum Inrush Current (ms)	0.2			
Minimum Ride-Through Time (ms) ³	12			

Notes:

1. Maximum rated output is limited to 1200W when operating at low-line input voltage (100-127V)
2. This is the minimum rating required to achieve 80 PLUS Titanium certification, see test reports published at <http://www.80plus.org/> for certified values
3. Time output voltage remains within regulation limits at 100% load, during input voltage dropout

For configuration-specific power specifications, use the Cisco UCS Power Calculator at this URL:

<http://ucspowercalc.cisco.com>

Environmental Specifications

The environmental specifications for the Cisco HyperFlex HX245C M6SX All Flash and Hybrid Server Nodes are listed in [Table 50](#).

Table 50 Environmental Specifications

Parameter	Minimum
Operating Temperature	<p>Dry bulb temperature of 10°C to 35°C (50°F to 95°F)</p> <p>Maximum temperature change of 20°C (36°F) per hour (a temperature change within a specified period of time and not a rate of change)</p> <p>Humidity condition: Uncontrolled, not to exceed 50% RH starting condition</p> <p>Derate the maximum temperature by 1°C (33.8°F) per every 305 meters of altitude above 900m</p>
Extended Operating Temperature	<p>5°C to 40°C (41°F to 104°F) with no direct sunlight</p> <p>Humidity condition: Uncontrolled, not to exceed 50% RH starting condition</p> <p>Derate the maximum temperature by 1°C (33.8°F) per every 305 meters of altitude above 900m</p>
Non-Operating Temperature	Dry bulb temperature of -40°C to 65°C (-40°F to 149°F)
Operating Relative Humidity	<p>10% to 90% and 28°C (82.4°F) maximum dew-point temperature, non-condensing environment</p> <p>Minimum to be higher (more moisture) of -12°C (10.4°F) dew point or 8% relative humidity</p> <p>Maximum to be 24°C (75.2°F) dew point or 90% relative humidity</p>
Non-Operating Relative Humidity	5% to 93% relative humidity, non-condensing, with a maximum wet bulb temperature of 28°C across the 20°C to 40°C dry bulb range.
Maximum Operating Duration	Unlimited
Operating Altitude	A maximum elevation of 3050 meters (10,006 ft)
Non-Operating Altitude	An elevation of 0 to 12,000 meters (39,370 ft)
Sound Power level, Measure A-weighted per ISO7779 LWAd (Bels) Operation at 23°C (73°F)	5.5
Sound Pressure level, Measure A-weighted per ISO7779 LpAm (dBA) Operation at 23°C (73°F)	40

Extended Operating Temperature Hardware Configuration Limits

Table 51 Cisco HyperFlex HX245C M6SX All Flash and Hybrid Server Nodes Extended Operating Temperature Hardware Configuration Limits

Platform ¹	ASHRAE A3 (5°C to 40°C) ²	ASHRAE A4 (5°C to 45°C) ³
Processors:	155W+	155W+ and 105W+ (4 or 6 Cores)
Memory:	LRDIMMs	LRDIMMs
Storage:	M.2 SATA SSDs NVMe SSDs	M.2 SATA SSDs NVMe SSDs HDDs or SSDs (Rear Bays)
Peripherals:	PCIe NVMe SSDs GPUs	PCIe NVMe SSDs GPUs VICs (Slots 1 and 4) NICs (Slots 1 and 4) HBAs (Slots 1 and 4)

Notes:

1. Two PSUs are required and PSU failure is not supported
2. Non-Cisco UCS qualified peripherals and/or peripherals that consume more than 25W are not supported
3. High power or maximum power fan control policy must be applied

Compliance Requirements

The regulatory compliance requirements for the servers are listed in [Table 52](#)

Table 52 Regulatory Compliance Requirements

Parameter	Description
Regulatory Compliance	Products should comply with CE Markings per directives 2014/30/EU and 2014/35/EU
Safety	UL 60950-1 Second Edition CAN/CSA-C22.2 No. 60950-1 Second Edition EN 60950-1 Second Edition IEC 60950-1 Second Edition AS/NZS 60950-1 GB4943 2001
EMC - Emissions	47CFR Part 15 (CFR 47) Class A AS/NZS CISPR32 Class A CISPR32 Class A EN55032 Class A ICES003 Class A VCCI Class A EN61000-3-2 EN61000-3-3 KN32 Class A CNS13438 Class A
EMC - Immunity	EN55024 CISPR24 EN300386 KN35



Americas Headquarters
Cisco Systems, Inc.
San Jose, CA

Asia Pacific Headquarters
Cisco Systems (USA) Pte. Ltd.
Singapore

Europe Headquarters
Cisco Systems International BV Amsterdam,
The Netherlands

Cisco has more than 200 offices worldwide. Addresses, phone numbers, and fax numbers are listed on the Cisco Website at www.cisco.com/go/offices.

Cisco and the Cisco Logo are trademarks of Cisco Systems, Inc. and/or its affiliates in the U.S. and other countries. A listing of Cisco's trademarks can be found at www.cisco.com/go/trademarks. Third party trademarks mentioned are the property of their respective owners. The use of the word partner does not imply a partnership relationship between Cisco and any other company. (1005R)

